

Daylighting Guide for Canadian Commercial Buildings

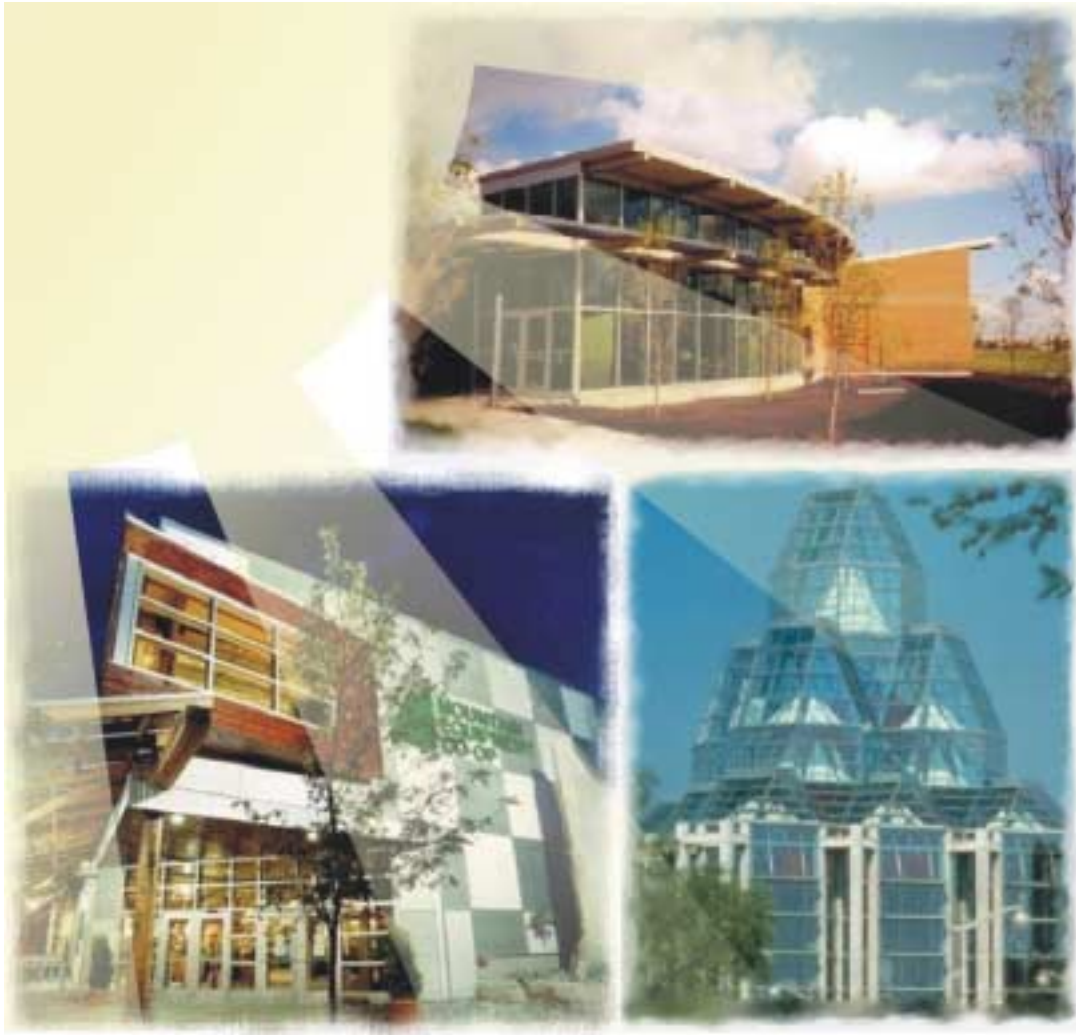

August 2002



Public Works and
Government Services
Canada

Travaux publics et
Services gouvernementaux
Canada

Canada

About This Guide

Although many daylighting guides exist, they are generally focused on moderate or warm climates. Canada's cool climate and geographic diversity brings with it unique building needs, which affect daylighting feasibility and practicality. This guide provides the building design practitioner with some tools and techniques to design high-performance daylit commercial buildings in Canada.

Daylighting is an integrative process, with each design decision affecting other aspects of the building design. This guide has been developed to follow the typical building design process from the initial planning stages through to commissioning. At the end of the process, the designer will achieve a daylighting design suitable to the Canadian climate and will be able to predict the performance of the building with the aid of the Building Design Adviser (BDA) software. A new version of the BDA software was developed by Lawrence Berkeley National Laboratory as a supplement to this guide. The BDA can be downloaded free-of-charge from: <http://gaia.lbl.gov/bda/index.html>.

The guide is divided into four parts, as follows:

Part 1 The Case for Daylighting. An argument for the use of daylighting is introduced. The unique challenges presented by the Canadian climate are summarized.

Part 2 Daylighting Concepts. Initial-stage planning parameters are outlined and specific functional objectives of the daylighting strategies are established. Basic decisions on building form and window size are followed by approaches for daylighting the building perimeter and core. Design considerations for glazing selection, shading strategies and occupant visual comfort are also discussed.

Part 3 Daylighting Integration. Proper integration of daylight with building systems is discussed with respect to electric lighting control and mechanical coordination. This integration can only be achieved through a carefully coordinated design and a calibrated daylight and electric lighting system. A computer software tool (BDA) is introduced to enable the designer to quantify the impact of their daylighting decisions in terms of lighting levels and energy savings.

Part 4 Case Studies. Three successful daylit commercial buildings in northern climates are described. These buildings are recognized as having achieved high levels of building performance.

Acknowledgements

This guide was prepared by Enermodal Engineering Limited of Kitchener, Ontario on behalf of Public Works and Government Services Canada (Ivan Pasini, Project Manager). This guide draws on information contained in “Tips for Daylighting with Windows” prepared by Lawrence Berkeley National Laboratory (LBNL). LBNL was also responsible for the development of the companion software “Building Design Advisor” (BDA). We would also like to thank Yukon Energy Corporation and Revenue Canada for agreeing to include their buildings in the case study section. Everyone’s support of this project is greatly appreciated.

Cover Images Credits: (top, left, right) – Alice Turner Branch Library, Saskatoon, SK (credit: Darlene Machibroda, Kindrachuk Agrey Architects Ltd.); Mountain Equipment Co-op, Ottawa, ON (credit: Mountain Equipment Co-op); The Great Hall, National Gallery of Canada, Ottawa, ON (credit: The National Gallery of Canada).

Table of Contents

About This Guide	2
Table of Contents	4
PART 1 The Case for Daylighting	5
A Canadian Context	6
Designing for Daylighting	11
PART 2 Daylighting Design Concepts	14
Design Basis	15
Building Orientation and Form	18
Daylighting the Perimeter	25
Daylighting the Core	32
Window and Glazing Selection	39
Shading and Visual Comfort	46
PART 3 Daylighting Integration	51
Optimizing Daylighting Design With BDA	52
Mechanical Coordination	61
Auxiliary Lighting Integration	64
Commissioning and Maintenance	70
PART 4 Case Studies	73
References	86

PART 1 The Case for Daylighting

“In a world newly concerned about carbon emissions, global warming, and sustainable design, the planned use of natural light in non-residential buildings has become an important strategy to improve energy efficiency by minimizing lighting, heating, and cooling loads. The introduction of ...daylighting strategies and systems can considerably reduce a building’s electricity consumption and also significantly improve the quality of light in an indoor environment.” [International Energy Agency Task 21]



The atriums, courtyards and daylit galleries of the National Gallery of Canada in Ottawa create a fascinating environment for visitors and provide improved lighting of the artwork.



Credits: top left – The Great Hall, NGC, Timothy Hursley; middle right – Water Court, NGC, National Gallery of Canada; bottom left – Canadian Galleries, NGC, Timothy Hursley

A Canadian Context

Advantages of Daylighting

All buildings receive daylight. A daylit building, however, is specifically designed to efficiently use daylight through adapted components and control strategies. The goal of daylighting design is to minimize energy use and maximize human comfort. The benefits of daylighting are far reaching, as the following schematic illustrates.

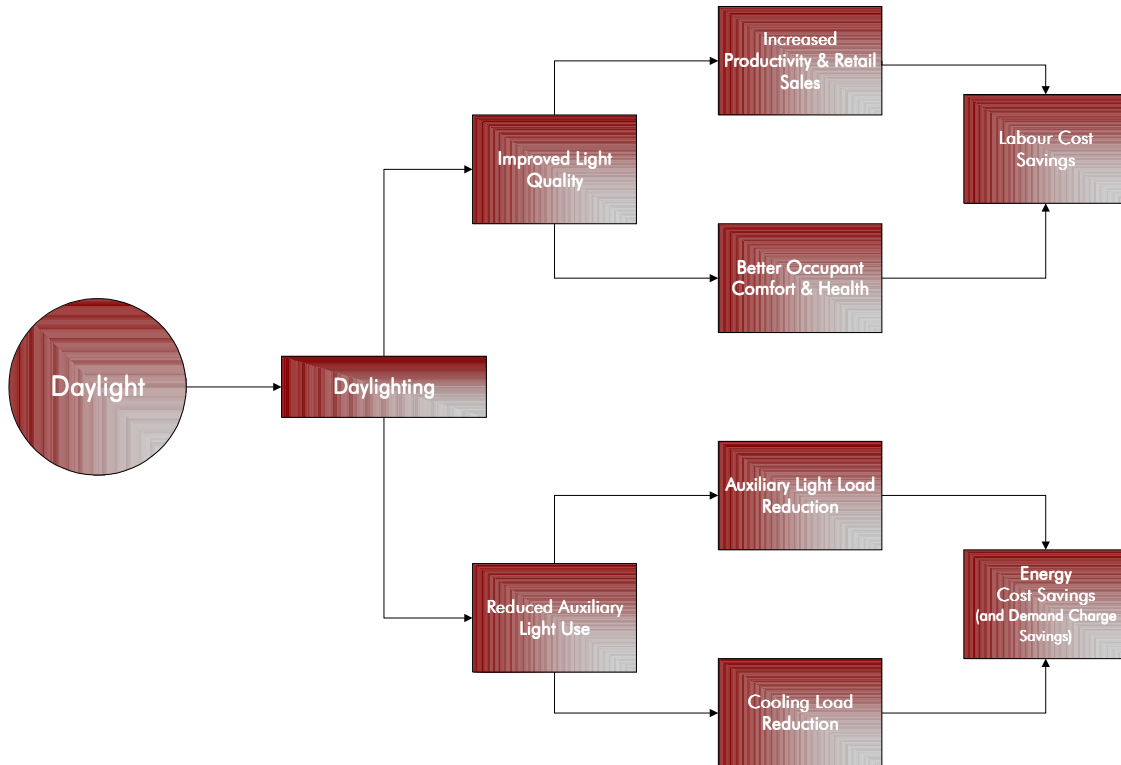

Benefits of Daylighting a Building

Improved lighting quality. Lighting quality refers to visual performance, visual comfort and ease of seeing. Daylight is a full spectrum source of visible light. That is, it imparts the same spectral distribution as sunlight (i.e. the same mix of colours and types of light). Unlike electric lights, which sometimes provide a limited spectral range that is concentrated in the blue/green or yellow/green range, daylight is best suited to human vision. Daylight can also provide any illumination level through proper design. These inherent characteristics of daylight contribute to improved lighting quality by enhancing colour discrimination and rendering.

Better occupant comfort and health. Another aspect of daylight is its variability throughout the day, leading to peaked visual interest. The eyes adapt easily to gradual illumination changes, changes not easily attainable with artificial light. Research has suggested a positive biological response to daylight variability. A properly designed office incorporating daylighting measures can provide a bright or soft mood created by the intrinsic colour and intensity of the light

PART 1 The Case for Daylighting

source and the use of warm interior colours. Working by daylight is believed to result in less stress and discomfort [Rusak et al, 1995].

Reduced light levels over the winter are the cause of major mood swings. This lack of light can lead to Seasonal Affective Disorder (SAD) in which people experience depression, fatigue, hypersomnia and over-eating. These problems can sometimes be resolved by exposure to longer periods of bright light. Lack of light also affects the secretion of the hormone melatonin by the pineal gland. Upsetting the rate of melatonin secretion can affect sleep, body temperature and promote tumor development [Rusak et al, 1995].

An important physiological effect of light exposure mediated by the eyes is the synchronization of the body's daily rhythms to local time. Disturbing the body's time clock can cause sleeping and eating disorders. Relatively bright light (above 2000 lux) is needed to reset the body's time clock. This issue raises the question as to whether the light levels in buildings should follow a daily pattern peaking at noon rather than being fixed at a constant level.

When daylighting measures result in increased window area, the occupants' sense of well-being is improved though greater exposure to outside surroundings. The quality of the view is determined by its "information content" and is maximized when three view elements are included: skyline, upright middle ground objects (e.g. trees, buildings) and horizontal foreground objects (e.g. streets, lawns).



Monitors enrich the learning environment at Dunlap Elementary School in Seattle, Washington

Credit: Barbara Erwine, Cascadia Conservation



The RADIANCE daylight rendering program can show daylight penetration into a modeled room. This program can be used to predict the outcome of daylighting strategies when designing a building.

Credit: Enermodal Engineering Ltd.

Increased productivity and retail sales.

People exposed to daylight are more productive, more efficient, miss less work (or school) due to illness, buy more and will even be more creative. Daylighting might also reduce the loss of worker productivity during power failures. By far the largest cost in any office building is the personnel cost, which over time can outweigh even the capital cost of the building. Satisfied workers are more productive and the potential health and performance benefits associated with daylighting could translate into significant productivity savings for a company over time. A typical company spends annually about \$20 per square metre for energy in an office building, about \$200 per square metre for rent, and about \$2,000 per square metre for labour [EBN, 1999]. Thus, a one-percentage-point improvement in worker productivity could save as much money annually as the company's entire energy budget.



A central roof monitor daylights the Mountain Equipment Co-op store to create a superior shopping environment.

Credit: MEC

Reduced auxiliary lighting load. Daylighting has become a major feature in energy-efficient design. In commercial buildings, interior lighting accounts for about 30 to 40% of electricity consumption. When

Daylighting Enhances Sales: A Case Study [EBN, 1999]

Recent studies report that daylighting can offer retail establishments a strong competitive advantage. This is supported by a study commissioned by PG&E that compares the retail sales performance of 108 stores operated by a large (unidentified) chain retailer. Two-thirds of the stores had skylighting, and the remaining one-third did not. Otherwise, the stores were very similar, with the same basic interior design, the same merchandise and all management and advertising handled by headquarters. The researchers used multivariate regression analysis to identify variables that had statistically significant effects on sales performance. The significant variables were the absence or presence of skylighting, the number of hours the store was open per week, the population of the zip code where the store was located, the average income in the zip code where the store was located, and the number of years since the store had been remodeled.

Of these five factors, skylighting was found to have the largest impact, boosting a store's sales index by an average of 40% (range of 31% to 49%). In other words, if a non-daylit store had average sales of \$20 per square metre over a given period, sales would be expected to increase \$26-\$30 per square metre if skylights were added. Statistical analysis found a 99.9% certainty that this is a true effect associated with daylighting.

Possible explanations listed by the authors for retail effects are more relaxed customers (similar to the effect of easy-listening music), better visibility of the merchandise, more attractive products because of improved colour rendition and better employee morale in the daylit stores, which might translate into better customer service.

PART 1 The Case for Daylighting

daylighting is combined with lighting controls to reduce auxiliary lighting, lighting energy can be reduced by up to two thirds. Economic benefits include reduced energy bills and equivalent capital or first costs due to reductions in space conditioning capacity.

Reduced cooling load. Compared with electrical lighting, daylight delivers more of its energy as visible light and less as heat. Therefore, daylight can reduce cooling loads when it replaces electric light. However, the benefit of daylighting is complex, as thermal losses and conductive gains through fenestrations are also factors to consider. Shading controls can reduce heat gains and appropriate window glazing selection is necessary to reduce thermal loss through windows. Overall, a well-executed daylighting design will significantly reduce cooling loads.

Reduced peak electricity demand. Daylighting is particularly well suited to commercial buildings, since those buildings are usually occupied during the day when natural light is available. When daylight availability and summer outdoor temperatures are high, daylighting can substantially reduce peak electric loads due to reduced cooling and electric lighting demands. Even in the winter, savings in electric lighting can reduce peak electrical demand. This will result in monthly savings in demand charges (accounts for the capacity that the utility must be able to deliver), but it also reduces pressure on the utility to add new generating capacity.



Daylight from north-facing skylights provide improved light quality and a better working environment in this manufacturing facility.

Credit: Enermodal Engineering Ltd.

Daylighting in Canada

Although many may perceive Canada as not well suited to daylighting design, there are many reasons why buildings in Canada should employ daylighting techniques.

Canadians spend a lot of time indoors, due to the severity and variability of the Canadian climate. Even with the cold temperatures experienced in the winter, technology advances in glazing materials allow for increased fenestration area, without a major increase in heating and cooling loads.

The number of commercial buildings in Canada is increasing with the growth in the service sector. According to Statistics Canada, in 1999 the service sector comprised 74% of the goods and services employment sector and is the dominant occupant of commercial buildings. Employees in this industry (which includes high-tech companies) are among the highest compensated. Thus, if daylighting was found to bolster productivity, it would translate into significant fiscal budgetary savings.

A Canadian Context

Daylight in Canada is predominantly diffuse, which lends itself to the possibility of more use of daylighting in our buildings. As will be seen in Part 4 of this guide, successful daylight commercial buildings in northern climates have used daylighting as an effective tool for improving energy efficiency and lighting quality. In Canada, buildings use the largest share of national primary energy, about 37% of all energy is spent on heating, cooling and supplying electricity to buildings. [Natural Resources Canada, 1996]

Designing for Daylighting

Daylight Availability

Contrary to what is commonly believed, Canada has year-round access to sufficient daylight for lighting commercial buildings. Only in the extreme north of Canada, due to the dark winter months, is there a lack of sufficient daylight hours for daylighting purposes. The average illumination level under overcast skies at latitude of 46° (i.e. close to most of the Canadian population) is 7500 lux. This is about 15 times more illumination than that required to perform average indoor tasks.

All building orientations have daylighting potential. It is a matter of using the appropriate techniques and technologies to take advantage of daylight. Shown below is an example of monthly solar radiation in Toronto. Notice the similarity between the amount of incident solar radiation on the south and north of the building in the summer months.

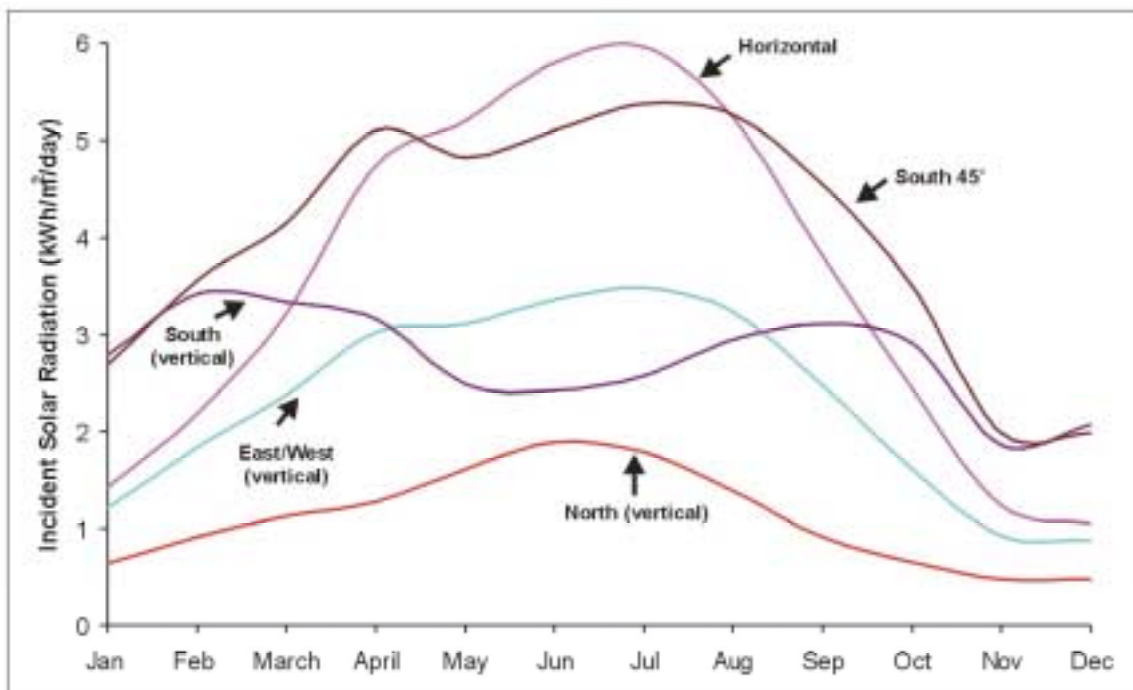

Average Monthly Solar Radiation for Toronto, Ontario

[Source: McKay, 1985]

Designing for Urban Areas

By using the daylighting techniques described in this guide, any building location can be utilized for daylighting purposes. Utilizing daylighting does become more difficult, however, in dense urban areas due to shading from neighbouring buildings. It is primarily the lower floors of the building that present a daylighting problem. Solutions for shaded, lower floors include atriums and light shafts, which allow light into the center of a building while still providing thermal resistance to heat loss. For top floors, toplighting (i.e. skylight) is an effective supplement to window daylight.

Designing for Cold Climates

By using appropriately insulated window assemblies, it is possible to admit natural light into a building without a significant loss of comfort, heat and energy. Careful selection of the window assembly will allow for large window areas on facades with limited solar availability.

A surface perpendicular to the sun can receive a substantial amount of energy – up to 1000 W/m². This energy is a major source of “free” heat on a cold day but is a major load on air conditioning equipment in the summer. Proper window orientation and shading strategies can maximize winter gains while minimizing summer gains.

Designing for Overcast Days

An overcast sky acts as a relatively bright, diffuse light source. This diffuse light is ideal for daylighting designs. Since it is not as bright as direct sunlight, diffuse light is an easier source to control.

If standard environmental conditions (i.e. overcast or rainy) are prevalent, an effective daylighting solution is to increase the window area. This will allow more daylight into the building. Larger than standard windows on north-facing facades are also an appropriate strategy. Precautions to avoid excessive heat transfer must be taken when selecting window assemblies in this case. See the section “Window and Glazing Selection” for more details.

The daylight strategy in predominantly cloudy conditions is to allow the diffuse light to access the interior of the building. This can be achieved with toplighting and through strategic window sizing and location (e.g. large windows, located high on the wall). The application of glass with high light transmission is also recommended.

Designing for Clear Days

The light available on a clear day is predominantly direct sunlight. Direct sunlight is the strongest light source available from the sun. It is also the most difficult to control. Glare and heat gain are the two most significant problems associated with direct sunlight.

Direct sunlight is so bright that the amount of incident sunlight falling on a small aperture is sufficient to provide adequate daylight levels in large interior spaces. Since sunlight is a parallel light source, direct sunlight can be easily guided and reflected deep into the building.

Designing for Daylighting

Daylight penetration can be enhanced using techniques such as reflective sills or a high window with a sloping lintel. Another effective method for enhanced daylight penetration is a split-blind technique. This technique employs the use of two different types of blinds in the upper and lower portions of the window. The lower blinds provide glare control and the upper blind can usually be left open.

Window openings are typically sized for the low daylight levels of overcast skies. However, large windows and direct sunlight will create uncomfortable glare and lead to space overheating unless shading or light reflecting or diffusing systems are used. Anticipating the reflectance angles of sunlight and utilizing different surfaces, i.e. light shelves, baffles and the ceiling, are some of the ways to increase daylight penetration into the floor cavity. Diffusing glazings, light pipes and window treatments can also reduce glare.

Daylighting Design Challenges

Daylighting is essentially a systems integration challenge for a multi-disciplinary design team. It is important that daylighting considerations involve the participation and cooperation of the owner/tenant, architect, electrical lighting designer, mechanical systems engineer, interior designer, operation and maintenance staff and the construction team.

Daylighting is unique in that it requires designers to address multi-disciplinary qualitative issues, in addition to the usual technical issues. For lighting to be truly effective, it must provide a comfortable and healthy visual environment that will support the activities of the occupants.

Even when excellent daylighting components or technologies are selected, poor integration can lead to unreliable building performance and uncomfortable work environments. Critical design elements include building orientation, fenestration size, lighting and control systems optimization and commissioning. This guide recommends techniques to address these issues.



With extensive glazing surface and careful shading, the Revenue Canada Burnaby-Fraser Tax Services Building, BC maximizes the amount of natural light used to illuminate the interior of the building.

Credit: Busby & Associates Ltd.

PART 2 Daylighting Design Concepts

The 10-Step
Daylighting
Design Process

*Daylighting
Design Concepts*

*Daylighting
Systems Integration*

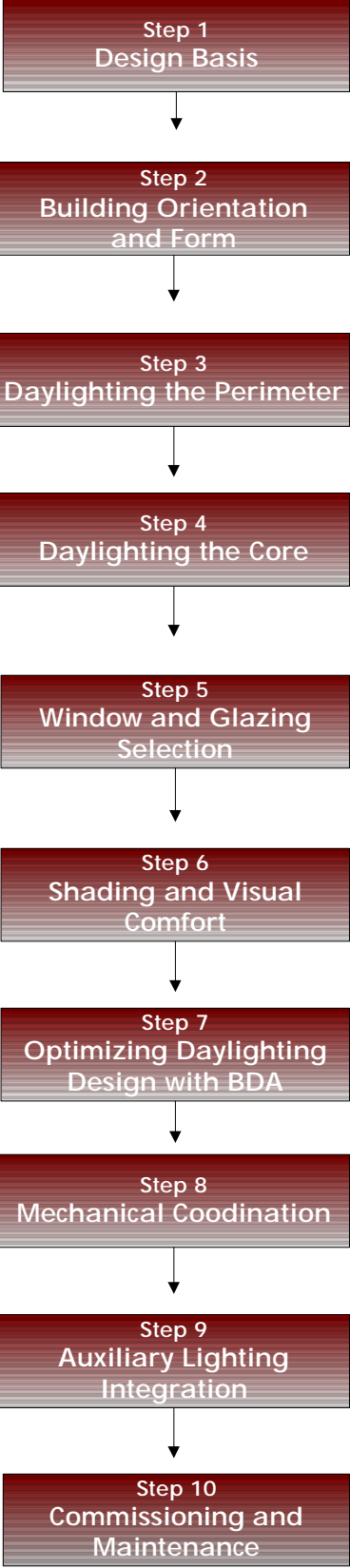

Goal

To define lighting requirements and to establish the role daylighting can play in meeting these requirements.

Fundamentals

It is necessary to define required light levels and lighting power densities (LPD) for each area in the building. The table on the following page lists the maximum values in the Model National Energy Code for Buildings. Given recent advances in electric light technology and controls, good lighting designers should be able to achieve up to 25% lower LPD. Daylight will provide additional light throughout the day, even on the most overcast days, and can reduce actual lighting power consumption by 50% or more. For illumination level guidelines, see the [IESNA Lighting Handbook, Ninth Edition](#). The IESNA also has a web site: <http://206.55.31.90/cgi-bin/lpd/lpdhome.pl>.

Illuminance is the density of a luminous flux incident on a surface and is measured in units of lux (lumens/m²) or footcandles (lumens/ft²).

Luminance is the physical measure of the stimulus which produces the sensation of luminosity (brightness) in terms of the intensity of the light emitted in a given direction (usually towards the observer) by a unit area of a self-luminous or transmitting or reflecting surface. It is measured by the luminous intensity of the light emitted or reflected in a given direction from a surface element, divided by the area of the element in the same direction. It is measured in units of candela per square metre (cd/m²) or footlambert (fL).

Lighting Power Density (LPD) is a measure of the amount of electric lighting installed in a space. It is expressed in units of lighting power to be supplied by the luminaire (Watt) divided by the area of the space to be lit (m²). By summing the wattage of all luminaires (including ballasts and associated controls) and then dividing by floor area one can calculate lighting power density. Theoretically the lighting power density should be proportional to the illuminance level. However, variables such as the efficiency of the lighting system and the efficiency of the space surfaces in delivering light to the work area will affect the lighting power density.

Design Basis

Building Type	Space Description	Max LPD (W/m ²)
Office	Atrium, first three floors	7.5
	Atrium, each additional floor	2.2
	Reception and Waiting Room	10.8
	Elevator Lobbies	8.6
	Lobby	18.3
	Conference/Meeting Room	19.4
	Corridor/Transition	8.6
	Electrical/Mechanical Control Rooms	16.2
	Office- reading, typing, filing	19.4
	Filing, inactive	10.8
	Mail Room	19.4
	Restrooms	8.7
	Stairs, active	6.5
	Stairs, inactive	4.3
Assembly Spaces	Auditorium	17.2
	Conference Centre/Exhibition Hall	28.0
	Art Galleries	20.4
	Lecture Hall/Classrooms	21.5
	Sports Venues, seating area	4.3
Hospitals	Emergency	24.7
	Laboratory	20.4
	Nurse Station	22.6
	Patient Room	15.1
	Operating Room	75.3
Hotels	Banquet, multi-purpose rooms	25.8
	Lobbies	20.4
	Guest Rooms	15.1
Warehouse	Fine Material	7.5
	Medium/Bulky Material	3.2
Library	Card File & Cataloguing	17.2
	Library-Audio Visual	11.8
	Reading Area	20.4
	Stack Mounted Area	16.2
	Ceiling Space	32.3
Retail (Sale area)	General Merchandising	35.5
	Fine Merchandise	34.4
	Mall Concourse	15.1
	Mass Merchandising	33.4
Bank	Banking Activity Area	30.1
	Customer Queuing, waiting area	11.8
Restaurant	Fast Food/Cafeteria Food Pick-up and Seating	14.0
	Kitchen	15.1
	Leisure, Dining, Seating Area	26.9

[Source: NRC/CNRC, Model National Energy Code for Buildings]

Techniques

Building Space Design

Decide on permissible lighting variability. The use of a building space will determine the tolerance for lighting variability throughout the day. This will in turn help to define suitable daylighting techniques. The following table identifies general rules for common space functions. Locations with high light levels and low variability will be the most difficult spaces to daylight due to the inherently variable and unreliable intensity of daylight throughout the day.

Daylighting Opportunity for Common Building Spaces

Space Function	Light Level	Acceptable Variability	Daylighting Ease
Hospitals, health care	High	Low	Low
Computer work, office	Medium	Medium	Medium
Corridor, washroom, eating area	Low	High	High
Retail (grocery, stores)	High	High	High

Identify areas/zones where daylighting will be most beneficial. Based on the function of the space as well as criteria discussed above, the best daylighting locations can be identified.

- Areas that require the least shading control and could benefit from high illuminance levels offer the most promising case for daylighting (e.g. entrance lobbies, reception areas, hallways, stairwells, atriums etc.).
- Low illuminance functions (e.g. mechanical room, storage room) are best suited for areas where daylight is inaccessible.

Determine the importance of daylighting. Based on the criteria discussed above, define the role that daylighting is to play in creating an energy efficient and attractive space. This role must be communicated to all design team members.

Use an integrated design team. It is essential that daylighting considerations involve the participation and cooperation of the owner/tenant, architect, electrical lighting designer, mechanical system engineer, interior designer/space planner, building automation specialist, operation and maintenance staff and the construction team. Daylighting is essentially a systems integration challenge for a multi-disciplinary design team.

Goal

To define building site, building orientation and building form to maximize daylight admission while minimizing excessive glare and thermal discomfort.

Fundamentals

The position of the sun varies according to the time of day and season. The building must be located and oriented to take advantage of this movement. Sun path charts show the variation in the sun's position. These charts can be used to determine the impact of shading on a building. The adjacent skyline can be sketched on the sun path chart to determine the impact of shading. The numbers in the boxes indicate the monthly fraction of solar radiation for that hour.

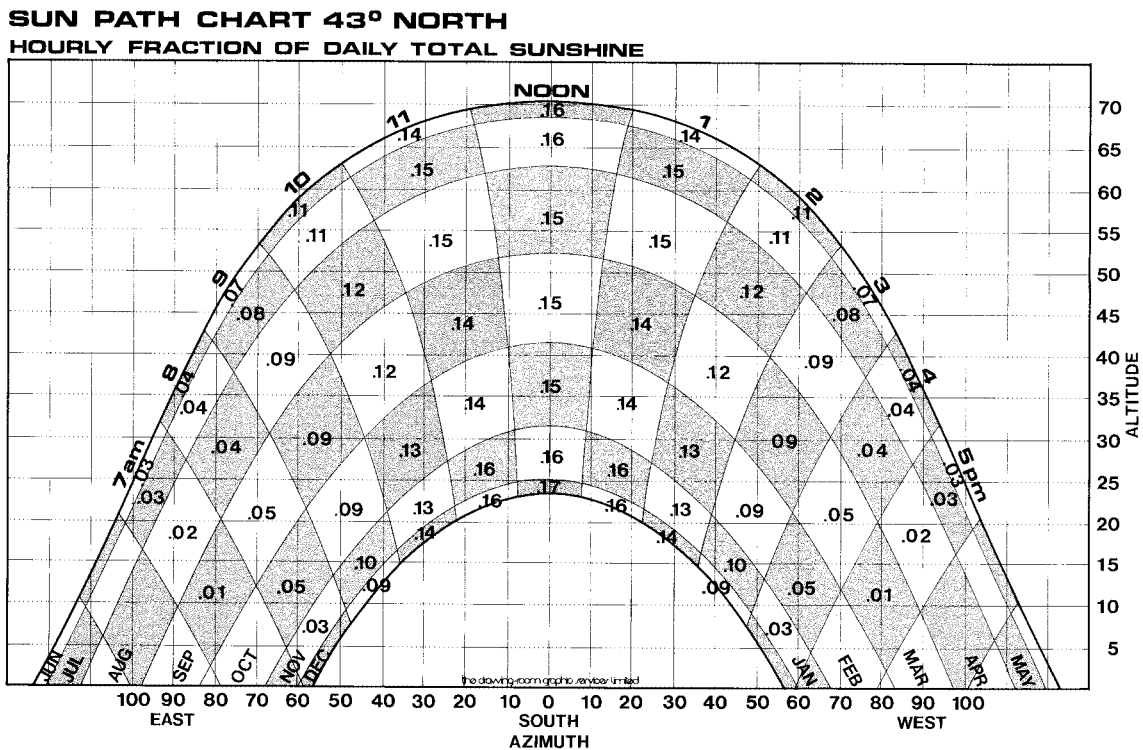

Sun Path Chart – 43° North

Sun Path Chart – 49° North

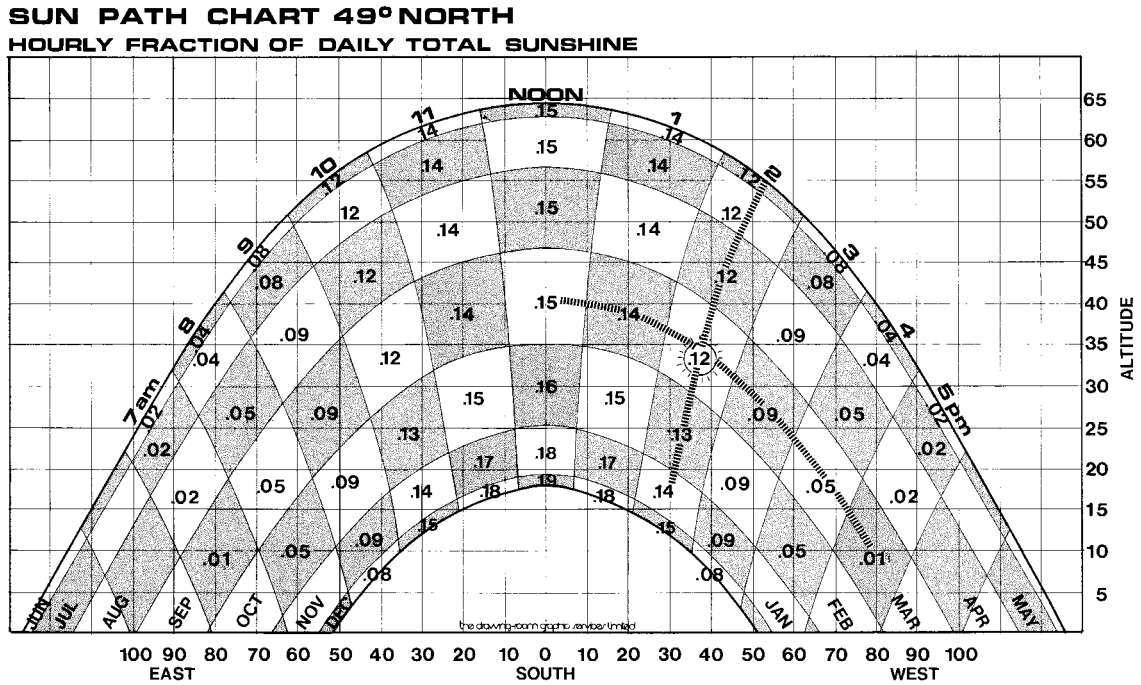

Sun Path Chart 53° North

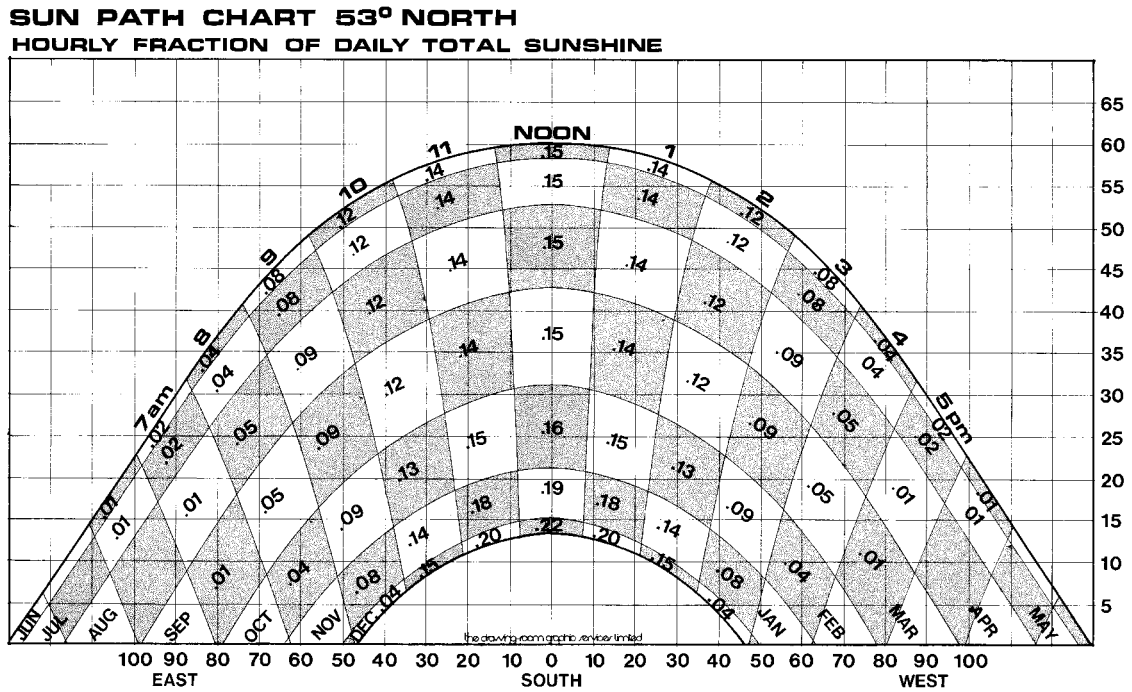

Credit: Reprinted with permission of the Drawing Room Graphics Services

Building Orientation and Form

If shading is a concern, the scale ratio can be used to locate the building on the site. The minimum horizontal distance required to ensure that the proposed building is not obstructed from surrounding buildings can be determined by multiplying the scale ratio by the surrounding building height (above 2 metres). For example, if an adjacent building in Toronto is 32 metres high, the proposed building should be a minimum of $(32-2) \times 1.69 = 51$ metres away to ensure adequate access to daylight.

Consider the daylighting needs of surrounding areas. Use the required sky exposure angle to determine maximum building height that can be built, without shading nearby buildings.

$$\text{Maximum Building Height} = \frac{(\text{Distance Between Setback Lines})}{\text{Scale Ratio}} + 2$$

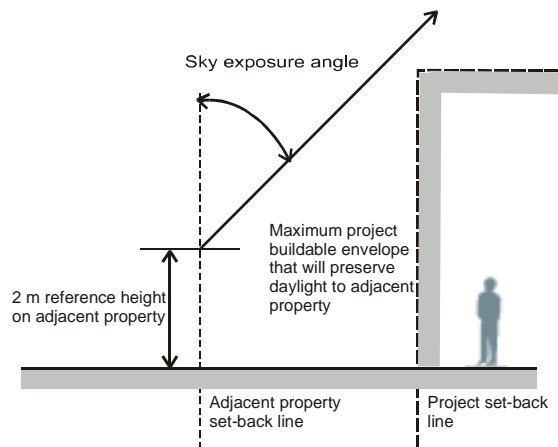

Using Scale Ratio to Determine Building Spacing

Building Orientation

Maximize southern exposure. The south facade allows the most daylight access and the best control of excess solar gain in the summer. This is the most desirable facade for daylighting and is best suited for rooms where variability in light levels is acceptable. Only marginal decreases in daylighting performance will occur for glazings facing 30° east or west of due south.

Optimize northern exposure. Although daylight exposure is less abundant on the north facade, the near-constant availability of diffuse skylight makes this the second most desirable orientation. For larger buildings where light uniformity and quality is key, large north-facing glazing areas can minimize electric light use.

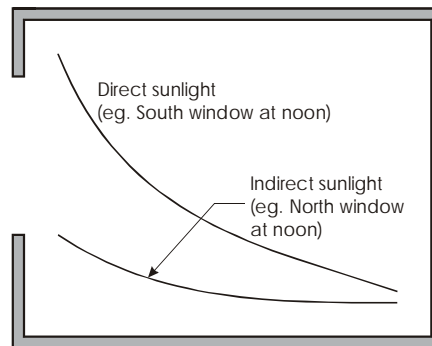

Light Distribution Throughout a Room

Minimize east-west exposure. It is difficult to control daylight penetration on the east and west facades because of low sun angles. Daylight variability is high since these orientations provide only half-day exposure to sunlight. The west facade especially suffers from large summer heat gain and serious glare problems from low solar angles at unwanted times, while providing little winter passive solar contribution.

Use different glazing treatments on each facade. If possible, vary the glazing selection by facade. For example, the use of a glazing with a lower solar heat gain coefficient (SHGC) on west windows will usually reduce the building's cooling load.

Building Form

Maximize perimeter exposure to daylight. Long and narrow footprints are better than square ones for access to daylight. Buildings can be arranged as a series of wings to minimize land requirements while still allowing access to daylight. The space between the wings should not be too narrow that they shade one another. Although square buildings have lower heating loads, daylighting the interior is difficult and the imbalance between perimeter heating loads and interior cooling loads necessitates a complex HVAC system. Multiple-storey buildings benefit the most from narrow plans that keep work areas within 10 metres of the exterior.

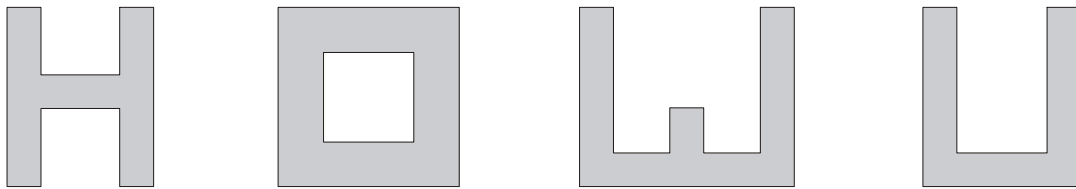

Examples of Building Footprints With High Daylight Access

Place service areas in central core. Locate rooms with low daylighting potential in the core. This would include elevators, mechanical/electrical rooms and service areas.

Select room depth to correspond with daylighting zone. Room depths of 1.5 times the room's window head height will allow sunlight to provide adequate illumination levels and provide for balanced light distribution. For standard office ceiling heights of 3 metres, the amount of floor space that can be daylit is approximately 4.5 metres from the window. A building width of approximately 12 metres allows all offices to have access to daylight.

Avoid exposed west zones for work areas. Daylight on west-facing surfaces is generally hard to control, which leads to high cooling loads as well as occupant visual discomfort from glare. The west facade is best used as

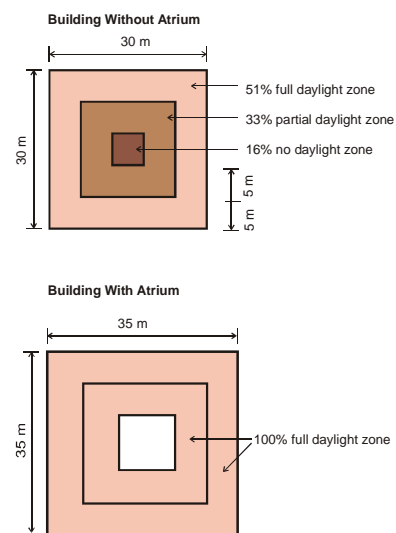

An atrium allows daylighting the core with only a modest increase in space requirements

service space or space where lighting variability is not of concern. West orientations can still be useful if proper external controls of direct sun and glare are applied.

Use low-rise buildings for greater daylight access. Single-storey structures have the potential to allow daylight penetration to virtually all interior areas. Multi-storey structures are more difficult to daylight. However, the trade-off between increased ground use over daylighting access should be considered.

Use atria to maximize core daylight. The figure opposite illustrates that by increasing the footprint of the building slightly, an atrium can provide full floor daylight.

Do not oversize atria. Atria are enclosed spaces that have large sunlight exposure. The effectiveness of atrium lighting will depend on the translucency and geometry of the atrium roof, the reflectance of the atrium walls and the geometry of the space (depth to width ratio). Designers often oversize atria or use glazings on multiple facades (e.g. vertical and horizontal glazings) for dramatic effect. When faced with space restrictions, consider a number of small atria or light wells. (See section “Daylighting the Core” for more sizing details.)

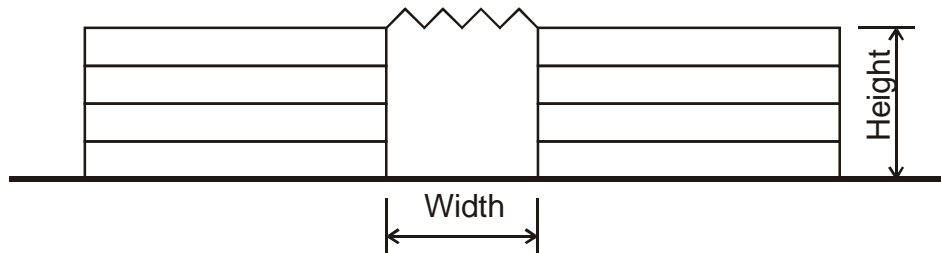

Optimal Atria Height to Width Ratio of 1

Use atria as buffer spaces. Atria require a large amount of energy if they are fully heated and cooled. Atria can be more effective as unconditioned or partially conditioned entrances, lobbies or interior corridors.

Place interior windows or openings into atria. Windows facing an atrium have a daylight potential similar to that of windows facing an open courtyard, but have reduced thermal losses and better acoustics. Placing surfaces with high reflectance within an atrium space can increase the depth of light penetration.

Place windows on two walls. Better lighting distribution can be achieved in spaces with windows placed on two sides, i.e. bilateral lighting.

Incorporate exterior features to increase daylight entry. Architectural components such as deep reveals, exterior fins, and light shelves can improve daylight distribution, control glare and diminish noise. Light contrasts can be softened using rounded edges. The depth of an effective

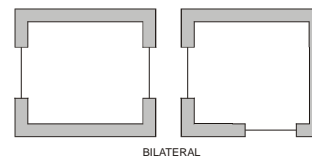
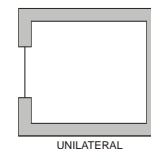

Bilateral and Unilateral Windows

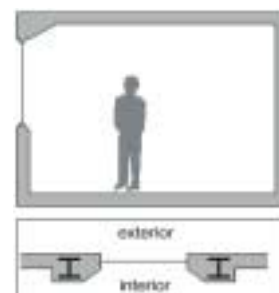

Use of Reveals at Window Edges

reveal should be between 23-30 cm at an angle of 60° to the windowpane. See adjacent figure.

Select light-coloured exterior surface materials. More daylight will be reflected into the interior by light-coloured surfaces than by dark surfaces. However, glazed or highly mirrored surfaces will tend to create glare if viewed directly. Light-coloured surfaces will also reduce cooling loads and the “urban heat island” effect. Interior surfaces should also be light coloured, see section “Daylighting the Perimeter”.

Urban Heat Island

In what has been coined the “Urban Heat Island”, urban development is known to raise ambient air temperatures due to the absorption and slow release of solar gains on dark surfaces. Natural ground cover, such as vegetation, tends to lower local air temperatures, while artificial surfaces, such as asphalt, tend to raise air temperatures. For example, the shade of a tree can lower air temperatures by approximately 3°C when compared to similar unshaded areas. Air temperatures over asphalt have been recorded as much as 14°C higher than nearby air temperatures. In general, the materials used in urban development tend to raise the ambient air temperatures to values higher than in similar rural environments. In addition, given the absorptive nature of the materials, the paved surfaces release the stored insolation later in the evening, tending to raise the night temperatures, in addition to those during the day. Cities are often warmer than surrounding suburbs by about 7°C during a summer day and by about 10°C at night. Incorporating green spaces and light coloured building materials can reduce the Urban Heat Island effect. [Lechner, 1991]

Goal

To select window placement, room size, window area and space configuration to provide adequate and uniform daylight for rooms around the building perimeter.

Fundamentals

The daylight factor is a common means of predicting whether the amount of daylight in a room is sufficient. Daylight factors are determined for an overcast sky.

The daylight factor describes the ratio of inside illuminance to the outside illuminance, expressed as a percent. A higher daylight factor indicates an increased availability of natural light. Daylight factor can be determined for a single point in the room or as an average for the room. The average value for the room is used in this guide. When different windows face different obstructions, calculate the average daylight factor for each case and sum the results.

A simplified equation for the average daylight factor is shown below.

$$\text{Average Daylight Factor} = \frac{V_T \cdot A_{\text{Glazing}} \cdot \theta}{A_s \cdot (1 - R^2)} \quad (\text{in } \%)$$

Where,

V_T = transmittance of glass including dirt effects (0.78 for clear double glazing, See section "Window and Glazing Selection" for other glazings)

A_{Glazing} = net glazing area

θ = the sky exposure angle, in degrees, the portion of the sky visible from the center of the window

A_s = total area of internal surfaces (i.e. sum of total surface area of walls including windows, ceiling and floor)

R = area weighted average reflectance of surfaces, expressed as:

$$R = \frac{\text{Wall Area} \cdot \text{Wall Reflectance}}{\text{Total Surface Area}} + \frac{\text{Ceiling Area} \cdot \text{Ceiling Reflectance}}{\text{Total Surface Area}} + \text{etc.}$$

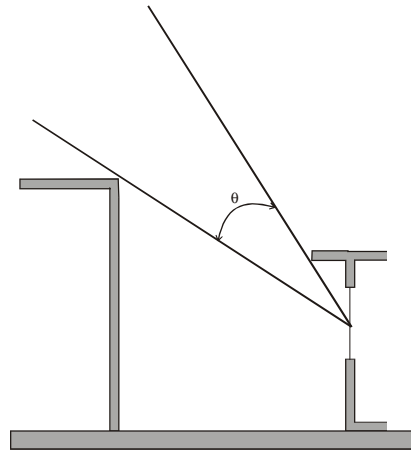

Sky Exposure Angle (Θ)

In general, at an average daylight factor of 5% or greater, a room will appear well lit and require electric lighting mainly for non-daylit times. An average daylight factor of 2% or less will appear under lit and require electric lighting near the back of the room. Daylight factors in between these two values permit ample use of daylight and daylighting controls integrated with the electric lights are generally economically justified.

The average daylight factor equation can also be used for toplighting situations provided the R-value is based on the average reflectance of the well surfaces.

Window Sizing

The average daylight factor equation can be used to estimate the required window-to-wall ratio (*WWR*) for adequate daylighting.

$$WWR = \frac{A_{Glazing}}{A_{GrossWall}} \quad (\text{expressed as a fraction})$$

Where,

$A_{Glazing}$ is the net glazing area (window area minus mullions and framing, approximately 80% of the opening)

$A_{GrossWall}$ is the gross exterior wall area (width of the bay by floor-to-floor height)

The following table can be used to easily calculate the required window-to-wall ratio for a standard room with the following properties:

- ceiling reflectance = 70%

Daylighting the Perimeter

- room height = 3m
- floor reflectance = 30%
- average daylight factor = 3%

If desired, the table can be modified for other daylight factors, although a daylight factor of 3% is suitable for most general lighting situations.

Room Geometry Factors

Room Width (m)	Room Depth (m)								
	3			4			5		
	Wall Colour								
	Dark	Medium	Light	Dark	Medium	Light	Dark	Medium	Light
2	19.3	15.8	10.3	23.8	19.5	13.0	28.3	23.3	15.7
3	16.4	13.5	9.2	19.9	16.5	11.5	23.4	19.5	13.8
4	14.9	12.4	8.6	18.0	15.0	10.8	21.0	17.6	12.9
5	14.0	11.7	8.3	16.8	14.1	10.3	19.5	16.5	12.3
6	13.5	11.3	8.1	16.0	13.5	10.0	18.5	15.8	11.9
7	13.0	10.9	7.9	15.4	13.1	9.8	17.8	15.2	11.7
8	12.7	10.7	7.8	15.0	12.8	9.6	17.3	14.8	11.5
9	12.5	10.5	7.7	14.7	12.5	9.5	16.9	14.5	11.3
10 +	12.3	10.4	7.6	14.4	12.3	9.4	16.6	14.3	11.2

To use the chart, simply select a room depth and wall colour. Reading down the room width, find the room geometry factor. Select the glazing visible transmission (either from manufacturer's data or the section "Window and Glazing Selection") and then calculate the *WWR*:

$$WWR = \frac{\text{RoomGeometryFactor}}{V_T \cdot \theta} \quad (\text{expressed as a fraction})$$

The *WWR* is typically close to 0.3. The required net glazing area ($A_{Glazing}$) can be calculated by multiplying the *WWR* by the wall area. The total window area (including window framing) can then be found by multiplying $A_{Glazing}$ by 1.25. In offices, any window area below desk height should not count for daylight purposes. If your case does not match the example provided above, use the full daylight factor equation.

To more accurately determine glazing size, use the BDA software. The BDA software calculates the changes in building energy consumption (lighting, heating, cooling) with changes in the ratio of window width and wall width. This knowledge can guide selection of the glazing area that minimizes energy cost. This software will be described in more detail in the section "Optimizing Daylighting Design With BDA".

Techniques

Window Placement

Use strip windows for uniform office lighting. A long strip of windows, rather than individual punched windows will provide sufficient lighting to a room without lighting contrasts.

Match location of work areas with windows. If punched windows are used, work areas should be in front of windows for north-facing offices and between windows where glare may be a problem.

Use low-e argon-filled windows. Standard double glazed windows have excessive heat loss, are a site for condensation and cause cold drafts. All windows should have a low-e coating and argon gas fill. Window selection is discussed further in the section “Window and Glazing Selection”.

Use separate apertures for view and daylight. To optimize daylighting with glare control, separate the tasks as shown in the figure. The structure provides a visual break and can be used to attach a light shelf or a shading mechanism. The upper glazing should be clear with high transmission properties and the lower window should use glazing with lower light transmission properties. Proper glare control should be considered for both glazings (see section “”).

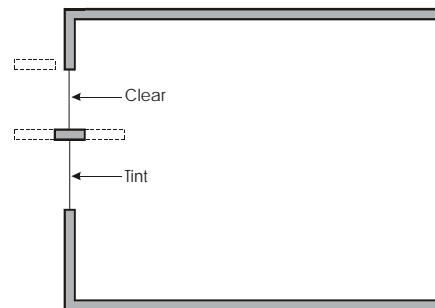

A Divided Window Provides for View and Daylight

Do not oversize windows. In most cases, conventional window areas (30% WWR) can provide adequate daylight if clear glazings are used. Oversized windows contribute to excessive heating and cooling loads and occupant discomfort.

Use a sloped ceiling to increase window height. A higher window will direct light onto the ceiling and deeper into the room, thus providing more uniform lighting. The ceiling should be smooth and light coloured.

Ensure glazing area is visible. Glazing in locations where it cannot be seen, such as below desk height, provides little daylighting benefit, wastes energy and may cause cold drafts in winter.

Use bilateral lighting over unilateral lighting. Whenever possible, position windows on two

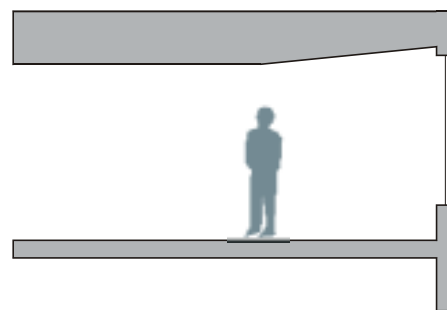

Sloped Ceiling Provides More Uniform Light

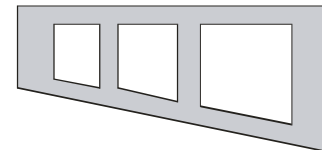
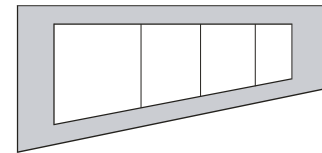

Strip and Punched Windows

Daylighting the Perimeter

walls instead of one, as this will provide significantly better light distribution and reduce glare. The windows on each wall will illuminate the adjacent wall and thus reduce the contrast between each window and its surrounding wall.

Minimize contrast between the window and the wall by splaying or rounding the inside edges of the window. Windows will create less glare if the adjacent walls are not dark relative to the window. Splaying or rounding the edges will create a light transition that is more comfortable to the eye.

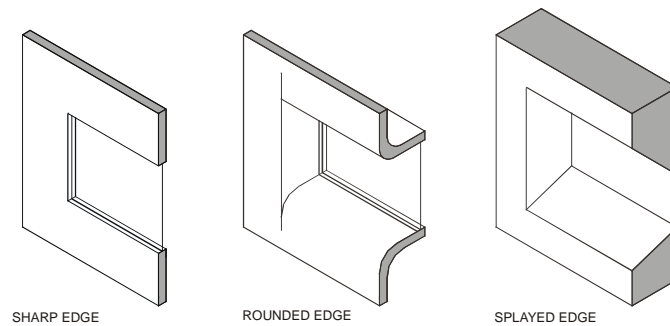

Inside Window Edges as Light Transitions

Use horizontal, not vertical, windows. Compared with vertical windows, horizontal windows provide a more even light distribution and are generally preferred by building occupants. Vertical windows tend to create lighting contrasts and cause disturbing glare. Proper window treatment for both should be considered. See section "Shading and Visual Comfort".

Room Size

Size rooms for daylighting. Light penetration for a typical ceiling height is 1.5 times the head height for standard windows. This ratio increases to approximately 2.5 for rooms with light shelves or south-facing windows under direct sunlight. This means that, with standard window and ceiling heights, adequate daylight should be available within 4.5 metres from the window (7 metres with light shelves). Room depths beyond this size will require supplementary lighting during the day.

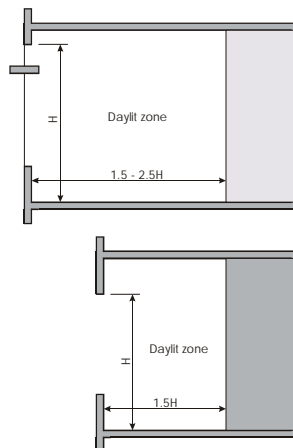

Daylight Depth as a Function of Window Height

Light Shelves

Light shelves are horizontal reflectors placed under a high window that bounce light deep into a room. If positioned correctly, light shelves can improve light distribution in a space by reducing glare and by providing more even light distribution. The figure shows typical light gradients in a room with a light shelf.

Use interior and exterior light shelves. Although exterior shelves provide the best light distribution, the use of both interior and exterior shelves is recommended for optimal all-year lighting.

Use light shelves for shading. Light shelves can also serve as overhangs to provide shading and glare control. More details about shading can be found in the section “Shading and Visual Comfort.”

Use a light surface colour for ceilings and light shelf. Use a smooth surface and light colour for ceilings. The top surface of the light shelves should be matte white or diffusely specular, and should not be visible from any point in the space.

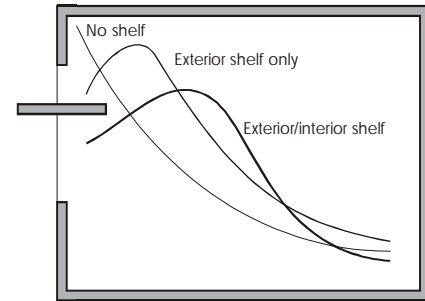

Light Distribution with Light Shelves

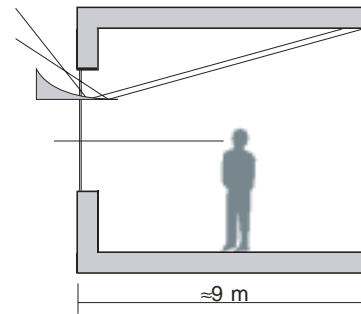

Interior and Exterior Light Shelves

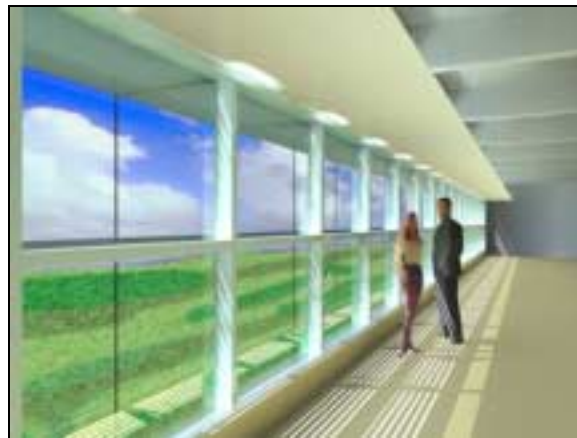

Light shelf designed by Musson Cattell Mackey Partnership for BC Gas Coastal Facility in Surrey BC

Interior Design and Space Layout

Arrange furniture for maximum daylight access. Ensure that furniture does not block sunlight reaching interior spaces.

Position dividers/partitions to enhance daylighting. Dividers should be placed perpendicular to the window and covered with a light-coloured diffusing material (e.g., fabric). If dividers must be placed parallel to the windows, keep the height as low as possible to maximize daylight penetration deeper into the room.

Light halls and corridors using clear partitions. Daylight from perimeter offices can reduce the lighting requirements in corridors by using partitions made of clear or translucent materials. The partitions can be glass walls, sidelights, or transoms around doors.

Avoid using dark colours. Dark colours impede daylight penetration into a space, so they should be avoided, except perhaps for accent effects. Light distribution can be improved by using light colours and light coloured objects, such as mullions and framing. Using light coloured sills and surfaces can also help distribute diffuse light into the interior. The colour of the back wall of the room is especially important for improving the uniformity of light distribution.

The IESNA recommends the following surface reflectances for optimal daylighting:

Surface Reflectance

Surface	Reflectance (%)
ceiling	80
wall	50-70
floor	20-40
furniture	25-45

Avoid reflective surface finishes. To avoid excessive glare, matte finishes, instead of specular surface finishes, are recommended.

Avoid positioning VDTs near direct sunlight. Do not place computers in front of windows. Computer screens are best-positioned perpendicular to windows and away from direct sunlight. To accommodate personal shading preferences, provide individual workspaces with shading control options, such as horizontal blinds.



Good VDT/task placement

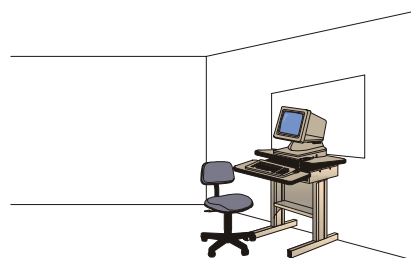

Poor VDT/task placement

Goal

To determine toplighting glazing placement, glazing size and interior design to provide daylighting for the building core.

Fundamentals

There are several toplighting methods including skylights, monitors and clerestories. The following diagram illustrates the various toplighting possibilities. The sawtooth is a variation of a clerestory.

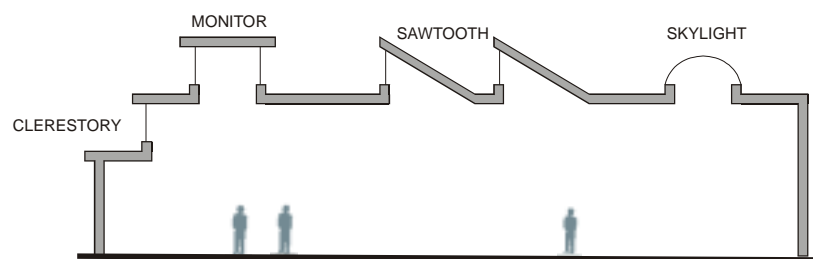

Example of Toplighting Strategies

The main advantages of toplighting over sidelighting are

- roof openings can provide lighting over larger areas whereas typical sidelighting is restricted to about the first 3 to 5 metres of room space
- the possibility of uniform and high illumination levels (especially with skylights). Clerestories and monitors offer increased opportunity to diffuse direct incoming radiation off the ceiling or shelves.

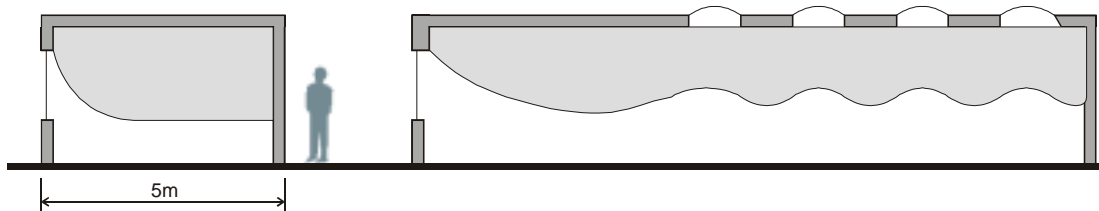

Improved Light Distribution in Long Spaces with Toplighting

The main disadvantages of toplighting when compared to sidelighting are

- without appropriate shading, there is an increased possibility of veiling reflections or direct glare
- high contrasts in the workspace causing visibility impairment

- toplighting provides no exterior view since the light source is above eye level.

Toplighting is best suited for lighting large spaces (e.g. factories, warehouses) rather than lighting specific tasks. Also, toplighting is not practical for multi-storey buildings (other than the top floor or in atria.)

Techniques

Horizontal and Sloped Skylight Strategies

Use skylights for high illumination levels. Horizontal, slightly curved, sloped or pyramid skylights receive a lot of direct light, especially during the summer months. The primary disadvantage of these skylights is the high imposed cooling load during the summer. Horizontal or south-sloping skylights are best suited to non air-conditioned buildings (e.g. warehouses.)

Space skylights according to ceiling height. The spacing between skylights should be equal to the floor-to-ceiling height.

Space skylights to take advantage of window placement. Skylight placement will depend on the presence of windows. They can be moved further into the interior if windows are present, as shown below. The size of the room will determine how many skylights are used.

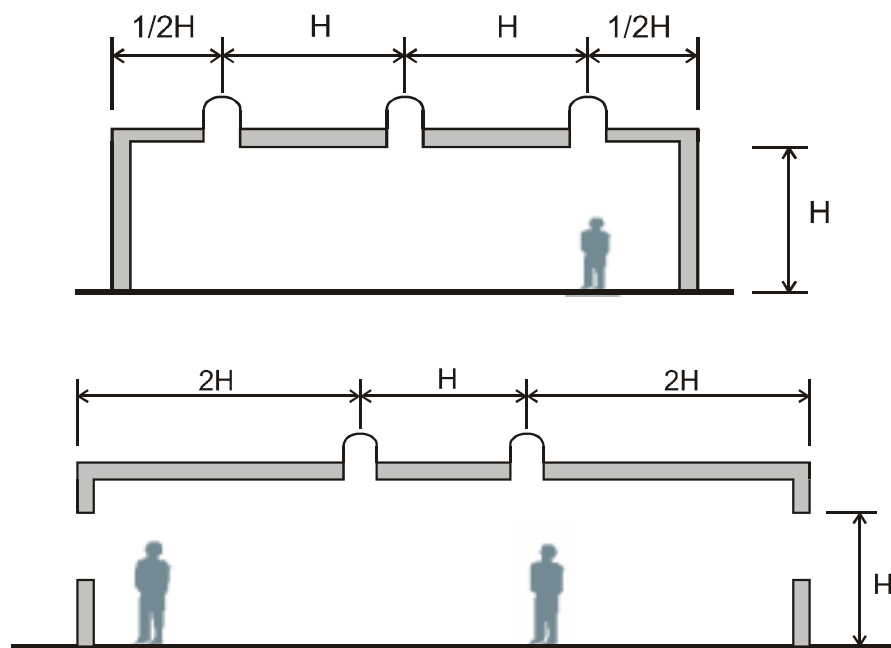

Skylight Placement as a Function of Building Height

Use sloped skylights. To improve light balances between winter and summer months, slope the skylight towards the north or south. A sloped skylight will collect more winter light and less summer light.

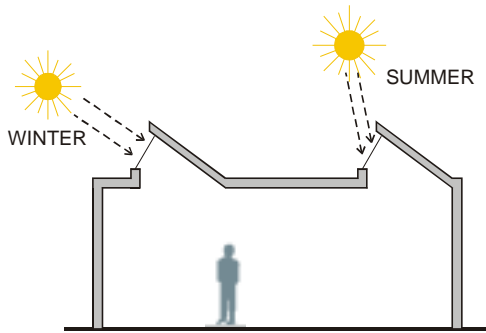

Sloped Skylight for Seasonal Light

Skylight Slope

South-facing: Skylight slope (from the horizontal) should be greater than the site latitude plus 23.5 degrees.

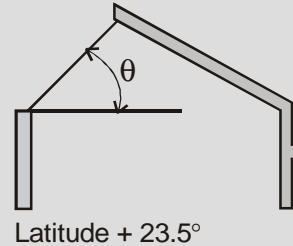

North-facing: Skylight sloped at latitude plus 23.5 degrees will receive the maximum daylight with a minimum amount of direct sunlight light entering the building.

Place skylights over the north wall. All walls, but especially the north wall, will act as a diffuse light reflector and will balance light entering windows from the south.

Avoid veiling reflections and glare. Veiling reflections are specular reflections from an object that result in glare, thus causing a “veil” and decreasing task visibility. Veiling reflections are possible from all overhead light sources. When moving the task out of the offending zone isn’t possible, try to diffuse incoming light to avoid bright light sources. This can be done using baffles to shield the light sources or by reflecting the light off the ceiling. To prevent direct glare problems, use translucent glazing since there is no view to block. Shading techniques are discussed further in the section “Shading and Visual Comfort”.

Use a splayed opening. Skylights will cause less glare and distribute daylight better when the sides of the light well are sloped outwards.

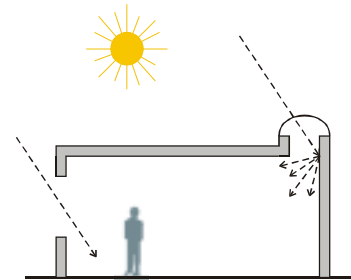

Light Diffusion after Entering Skylight

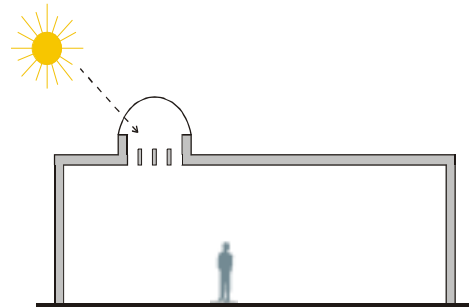

Diffuse Incoming Light for Glare Reduction

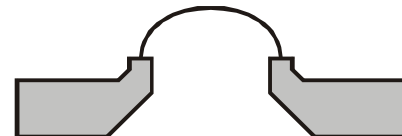

Splayed Opening on a Skylight

Use shades and reflectors. To optimize skylight performance, shade the skylight from the summer sun and reflect the sun into the skylight in the winter using a white diffusing reflector.

Use high ceilings to minimize glare. In high and narrow rooms, glare will be minimized as the light source will be out of the occupant's field of view. The light is able to diffuse before it reaches the floor.

Use interior reflectors. To diffuse sunlight and reduce glare, use an angled reflector.

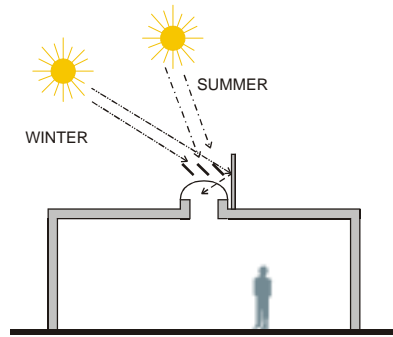

Seasonal Use of Shades with Skylights

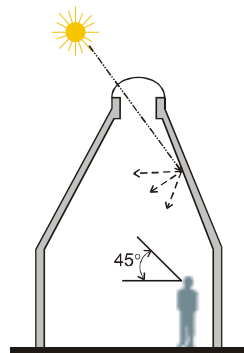

Optimal Skylight Location

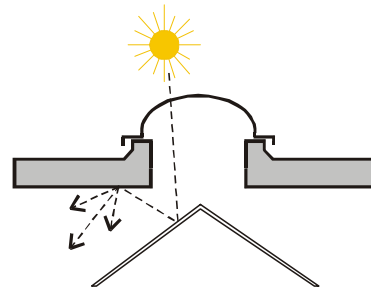

Interior Reflectors Diffuse Light

Clerestory and Monitor Strategies

Use clerestories instead of horizontal skylights. Use vertical or near-vertical clerestories to avoid the common problems associated with horizontal skylights (the collection of heat in the summer and insufficient light and heat in the winter). The clerestory should face south or north. South-facing clerestories should have an overhang. North-facing clerestories can be sloped at the maximum sun altitude angle to increase daylight without glare (i.e. latitude plus 23°).

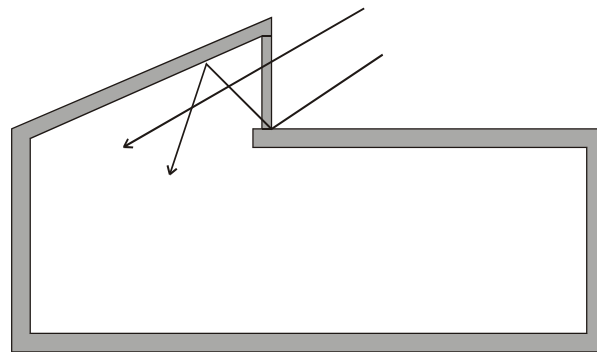

Clerestories Avoid Many of the Problems of Horizontal Skylights

Daylighting the Core

Orient clerestories to face north or south. South-facing openings will collect more sunlight in the winter and can be easily shaded from direct sunlight. North-facing openings deliver a low, but consistent light with little glare. East and west openings should be avoided due to difficulties associated with shading the sun at low altitude angles.

Space clerestories according to building height. The recommended spacing for clerestories and monitors is shown below.

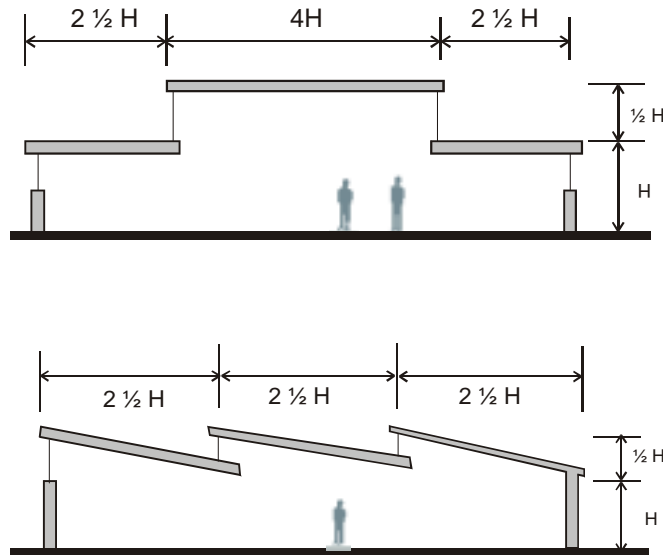

Clerestory Spacing as a Function of Building Height

Maximize diffuse light entry with reflective roof. Light that reflects off a reflective roof will provide lighting of low glare and high quality. Reflective roofs also reduce heat gain through the roof.

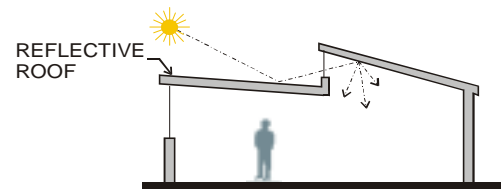

Reflective Roof Used With Clerestory

Use suncatcher baffles with north and east/west clerestories. A baffle will increase light collection for north, east and west facing clerestories. Note that east/west clerestories are not recommended.

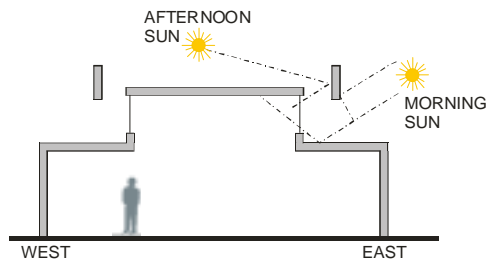

Suncatcher Baffles With East/West Clerestories

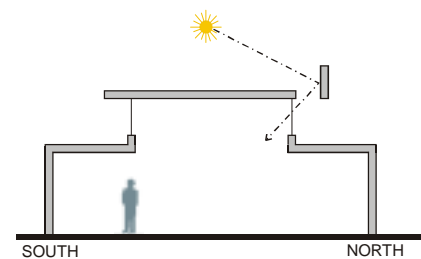

Suncatcher Baffles with North/South Clerestories

Bounce light off interior wall. For south-facing openings especially, bouncing light off an interior wall will diffuse the entering sunlight.

Use overhangs and diffusing baffles. South-facing clerestories can deliver high illumination without glare when appropriately designed baffles are implemented. Design baffle spacing to avoid direct sunlight and direct field-of-view glare. The ceiling and baffles should have a matte, high-reflectance finish.

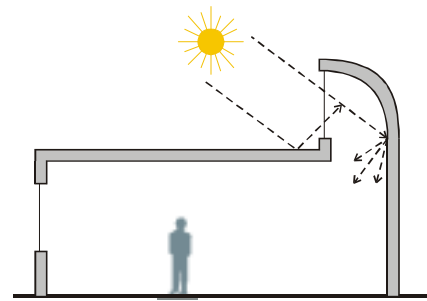

Diffuse Light with Interior Walls

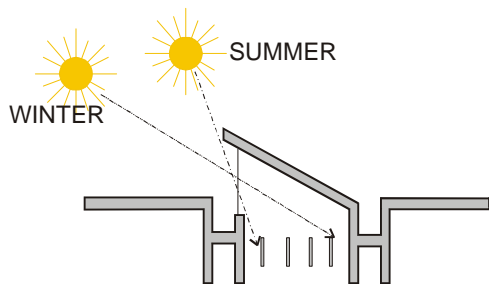

Minimize Clerestories Glare with Baffles and Overhangs

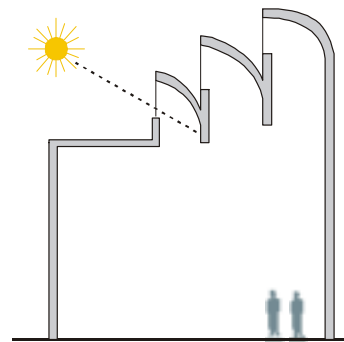

South-facing Clerestories with Light Scoops

Use shielded light scoops to prevent direct glare. Constant cool light can be obtained from south-facing light scoops, which are a variation of the sawtooth clerestory.

Toplight Sizing

The average daylight factor equations given in the section “Daylighting the Perimeter” apply to toplighting as well as sidelighting. With toplighting, the sky exposure angle (θ) ranges from 90° for clerestories, up to 180° for horizontal skylights. Similar to the *WWR*, the window-to-ceiling ratio (*WCR*) is the ratio of the glazing area to the total ceiling area for a space.

The following table can be used to easily calculate the required *WCR* for a standard room with the following properties:

- ceiling reflectance = 70%
- room width = room length
- floor reflectance = 30%
- average daylight factor = 3%

If desired, the table can be modified for other daylight factors, although a daylight factor of 3% is suitable for most general lighting situations.

Room Geometry Factor

Room Floor Area (m ²)	Room Height (m)								
	4			7			10		
	Wall Colour								
	Dark	Medium	Light/None	Dark	Medium	Light/None	Dark	Medium	Light/None
10	15.4	12.6	8.2	13.8	11.0	6.6	13.1	10.4	5.9
30	18.1	15.2	10.9	15.3	12.5	8.1	14.2	11.5	7.0
50	20.0	17.0	12.8	16.4	13.5	9.2	15.0	12.2	7.8
70	21.5	18.4	14.3	17.3	14.4	10.1	15.6	12.8	8.4
90	22.8	19.7	15.6	18.1	15.1	10.9	16.1	13.3	8.9
110	23.9	20.8	16.7	18.7	15.7	11.5	16.6	13.7	9.4
150	26.0	22.8	18.8	19.9	16.9	12.7	17.4	14.5	10.2
170	26.9	23.7	19.7	20.4	17.4	13.2	17.8	14.9	10.6
200	28.1	24.9	20.9	21.2	18.1	14.0	18.3	15.4	11.1

To use the table, simply select a room height and wall colour and then read off the corresponding room geometry factor for the room floor area. Select the glazing visible transmission (either from manufacturer’s data or the section “Window and Glazing Selection”) and then calculate the *WCR*:

$$WCR = \frac{\text{RoomGeometryFactor}}{V_T \cdot \theta} \quad (\text{expressed as a fraction})$$

The required glazing area ($A_{Glazing}$) can be calculated by multiplying the *WCR* by the ceiling area. The total window area can then be found by multiplying $A_{Glazing}$ by 1.25.

Interior Design

Locate work areas away from direct sunlight. Desks and other workstations should not be in locations where the user will suffer from direct glare.

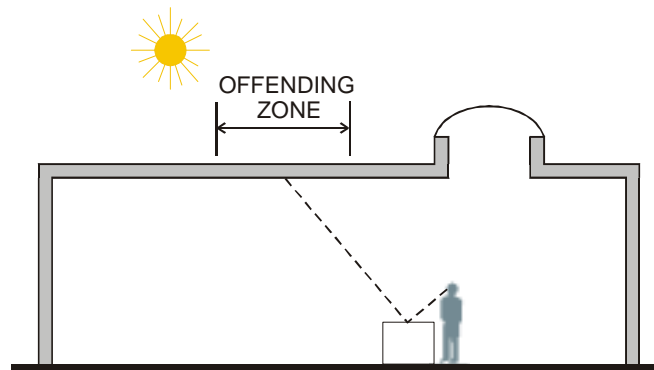

Careful Location of Tasks to Avoid Direct Sunlight

Paint ceiling white. Skylights will create less glare if the adjacent ceiling is a light colour. The use of white ceilings as well as light-coloured walls and floors will help to distribute overhead light within the space.

Goal

To select window characteristics to minimize energy use and maximize daylighting potential.

Fundamentals

The following table summarizes major window glazing types and lists the corresponding average value of the key properties (U-value, light transmission, and Solar Heat Gain Coefficient) for the window.

Typical U-values for Glazing and Window Systems

Glazing System	Center-of Glass U-value (W/(m ² K))	Total Window U-value (W/(m ² K))	
		Typical Frame	High-Performance Frame
Single	5.91	6.30	5.90
Double	2.73	3.51	3.03
Double, hard low-e + argon	1.70	2.63	2.19
Double, soft low-e + argon	1.42	2.39	1.94
Triple	1.76	2.63	2.22
Triple, hard low-e + argon	1.25	2.19	1.79
Triple, soft low-e + argon	0.80	1.79	1.40

[Source: 1997, ASHRAE Fundamentals Handbook (SI), Table 5, p 29.8.]

Typical Light Transmission and SHGC for Glazing Systems

Glazing Light Transmission/Solar Heat Gain Coefficient (in percent)					
Glazing System (6mm glass)	Clear	Blue/Green	Spectrally Selective	Grey	Reflective
Single	89/81	75/62	71/51	43/56	20/29
Double	78/70	67/50	59/39	40/44	18/21
Double, hard low-e + argon	73/65	62/45	55/34	37/39	17/20
Double, soft low-e, + argon	70/37	59/29	53/27	35/24	16/15
Triple	70/61	59/42	53/34	34/40	17/19
Triple, hard low-e + argon	64/56	55/38	52/31	32/36	15/17
Triple, soft low-e, + argon	55/31	52/29	50/27	30/26	14/13

[Source: 1997, ASHRAE Fundamentals, Table 11, p. 29.25]

Visible transmittance (V_T) A measure of the fraction of visible light that passes through a glazing.

Visible reflectance The fraction of visible light that is reflected off the glazing. It is usually measured for both the inside (the interior mirror effect at night) and the outside (exterior view) of a glazing.

Solar Heat Gain Coefficient ($SHGC$) This parameter is a ratio of total transmitted solar heat to incident solar energy for a glazing. The ratio ranges between 0 and 1 and is an indication of the total heat transfer of the sun's radiation. An older, similar term, the Shading Coefficient (SC), is the ratio of the solar heat gain of a glazing to that of a clear single glazing. $SC \approx 1.15 \times SHGC$.

U-value A measure of heat transfer through a glazing per degree temperature difference across the window expressed in $W/(m^2K)$.

Ultra-violet transmittance The percentage of ultraviolet radiation that passes through a glazing.

Spectral selectivity The ability of a glazing material to respond to different wavelengths of solar energy. Ideally the glazing will admit visible light, but reject unwanted invisible infrared heat.

Glazing Luminous Efficiency (K_e) The ratio of visible transmission to the $SHGC$, with theoretical values ranging from 0 to 2. For clear glass $K_e \approx 1$; spectrally selective glazings have a $K_e > 1$.

Techniques

Reducing Window U-value

Define required window U-value. The first step in window selection is to define the required window U-value because in most commercial buildings, windows are the major component of heat loss.

The following table is a guide to the required window U-value for your region. This table is adapted from the Model National Energy Code for Buildings and is for fixed glazing without a sash.

A high performance window assembly will have at least one low-e coating, an argon gas fill and an insulating-edge spacer. High-performance frames are non-metal (e.g. fibreglass) or have a minimum 12 mm thermal break. The cost premium for high performance windows is approximately \$30 to \$100 per square metre of window.

Maximum Recommended Window U-values

Region	Principal Heating Source			
	Electricity, Other	Oil	Propane	Natural Gas
	Maximum U-value, W/(m ² °C)			
Newfoundland	1.80	3.20	3.20	-
PEI	1.80	2.10	2.10	-
Nova Scotia	1.80	3.20	2.10	-
New Brunswick	2.10	3.20	1.80	-
Quebec, Southern	2.10	2.10	2.10	2.10
Ontario, Southern	2.10	3.20	3.20	3.20
Manitoba, Southern	2.10	2.10	2.10	2.10
Saskatchewan	1.80	1.80	1.80	3.20
Alberta, Southern	2.10	2.10	2.10	3.20
British Columbia, Southern	3.20	3.20	3.20	3.20
Northern Canada	1.20	1.80	1.80	-

Note: Data is for WWR of up to 0.4

Use low U-value windows to reduce building heating load. Low U-values will reduce peak heating loads and can eliminate or reduce the need for perimeter heating. Conventional windows have high U-values because of poor glazing, metal edge-spacers and narrow thermal breaks.

Use multiple layers of glazing. The insulative effect of the air trapped between panes of glass can significantly reduce heat conduction through the window. To achieve U-values below 1.5 W/(m²K) requires triple-glazed windows.

Consider the use of film technologies. Using two films with a double glazed window will provide the thermal performance of a quadruple-glazed assembly at considerably less weight.

Use inert gas fills. The most common fill gases are argon and krypton. Argon is more commonly used despite the fact that krypton has better heat retaining properties. Krypton is approximately 200 times more expensive per unit volume than argon, although, since it works well in small pane spacings, it is used in situations where a reduction in the overall thickness of a multi-pane assembly is desired. The cost of inert gas window fills is about \$3 to \$5/m² of window.

Use low-e coatings for most applications. Applying a low-emittance metallic oxide film to a glazing will help to minimize radiant heat transfer. Low-e coatings are a mature and cost-effective technology. Most low-e coatings have high visible transmission so they will not reduce daylight availability. Some types of low-e coatings reflect solar gains while others transmit the solar gains.

Use “warm-edge” spacer systems. Superior performance can be obtained with insulating spacers as they contain few, to no, metal components. Not only do insulating spacers reduce window U-value, the main benefit is an increase of the inside surface temperature so that condensation is minimized.

Consider non-metal frames where appropriate. Metal is durable, but is significantly more heat conductive than wood or vinyl. Wood is a good insulator, but has less resistance to decay (e.g. weather, moisture, warpage).

- Vinyl frames have thermal and structural properties similar to wood, although large window sizes have reduced thermal properties since they must be reinforced with metal.
- Fiberglass frames are lightweight, structural and are resistant to the natural elements. They have a low thermal conductivity, so suffer little heat loss. Heat loss is also reduced by the fact that the strength of fiberglass allows for a smaller frame height, lowering the frame area as a percentage of total window area. The main drawback to fiberglass frames is the higher cost.



Low-conductivity Window Frame Construction

Ensure that the thermal break is effective. A narrow thermal break is not as effective as a wide one. Thermal breaks should be at least 8 mm wide, although products are available with 25 to 50 mm thermal breaks. Separate extrusions that fit into the frame extrusions are better than the commonly applied urethane “pour-and-debridge” breaks.



Left to right: Vinyl, Butyl-Rubber and Silicone-Foam Insulating Edge Spacers

Types of Low-e Coatings

There are two types of low-e coatings: soft and hard. Both coatings have low emissivity values for reduced radiative heat loss, are durable (if in a sealed glass unit) and are clear to the human eye. They do have slightly different heat transfer properties so that each coating has advantages over the other depending on the application.

Soft or Sputtered Low-e Coatings: These coatings are sprayed onto glass to achieve a low emissivity. They are referred to as “soft” because they are susceptible to degradation if exposed to the atmosphere. Provided they are in a sealed glass unit, they will retain their properties. Early soft coats had an emissivity of 0.1. More recently developed coatings achieve emissivities of less than 0.05. Most of these coatings are spectrally selective, in that they have high visible light transmission but low solar transmission. These coatings are best suited to medium-to-large commercial buildings or buildings with high air conditioning loads. Product trade names include Cardinal Low-e squared, AFG Ti-R, AFG Ti-AC, PPG Solarban 60, and Guardian Low-e Performance Plus II.

Hard or Pyrolytic Low-e Coatings: These coatings are applied during the manufacture of the glass. They are extremely durable even when not in a sealed glass unit. The emissivity is slightly higher than soft coats at 0.15 to 0.20. Most hard coatings have high visible and solar transmission. These coatings are best suited to residential and small commercial buildings or locations where air conditioning is rarely used. Product trade names include Pilkington Energy Advantage, AFG Comfort E2 and PPG Sungate 500.

There are two notable exceptions to these categorizations. Pilkington Solar E is a hard coating with a low solar transmission and AFG Ti-PS is a soft coating with a medium range solar transmission. The solar/optical and thermal properties of any glazing system can be evaluated using the FRAMEplus software. It can be downloaded free-of-charge from www.frameplus.net.

Optimizing Window SHGC and V_T

Select a glazing that will provide the appropriate atmosphere for the space. Glazing with a high V_T will appear relatively clear and provide sufficient daylight and unaltered views, although can contribute to glare problems. Glazing with a low V_T will appear under-lit in overcast weather conditions and will rarely provide sufficient lighting for most tasks, although glare problems will be somewhat reduced.

Consider the effect of heat gain. For smaller commercial buildings, the heating load is more important than the cooling load so glazings with a high *SHGC* may result in lower overall energy use. A clear outer glazing with low-e on the inner glazing is the best option.

For a large commercial building, cooling loads are a major concern, so tinted glass or solar control low-e coating may be the best choice.

Use low U-V transmission glazings where space contents are valuable. Since U-V can damage fabrics and paintings, a low U-V transmission glazing should be considered where such exposure is undesirable, such as in museums.

Use blue/green or spectrally-selective glazings over grey and reflective glazings. Spectrally-selective glazings are specially designed for high visible light transmission and low solar heat gain coefficient.

Avoid reflective glass. Reflective glass is coated with thin layers of metal (e.g. copper, silver, gold) or with semiconductors that reflect the solar heat gain and light. Because of their high daylight reflection, reflective glass is not compatible with daylighting design.

Locate low-e coating to achieve desired SHGC. A successful coating is also dependent on its location within the glazing assembly. By convention, glazing surfaces and layers are numbered from the outside in. If solar heat gain is to be increased (e.g. in residential or small commercial applications), then a coating on Surface 3 will be more effective than on Surface 2. For medium and large commercial buildings, the low-e coating is better on Surface 2. The U-value and inside center-glass temperature is not dependent on location.

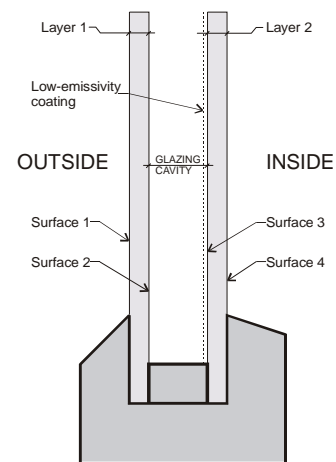

Typical Double-Glazed Window Assembly

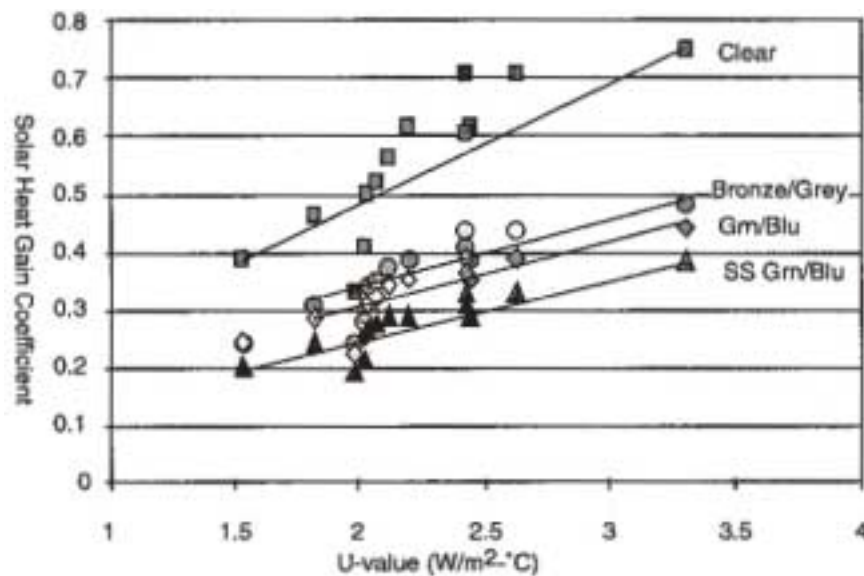

Solar Heat Gain Coefficient vs. U-value for Various Glazing Types [Enermodal, 1995]

Window and Glazing Selection

Do not confuse SHGC with visible transmission. A window that lets in a lot of solar radiation contributes to the cooling load, but a window that lets in visible light can actually reduce the cooling load, if daylighting is used to reduce the amount of required electric light. Less electric lighting means less heat generated by the lights, which translates into a lower cooling load.

Choose a glazing with a high efficiency ratio (K_e). A high K_e indicates that the glazing allows entry of the most visible light for the least solar gain.

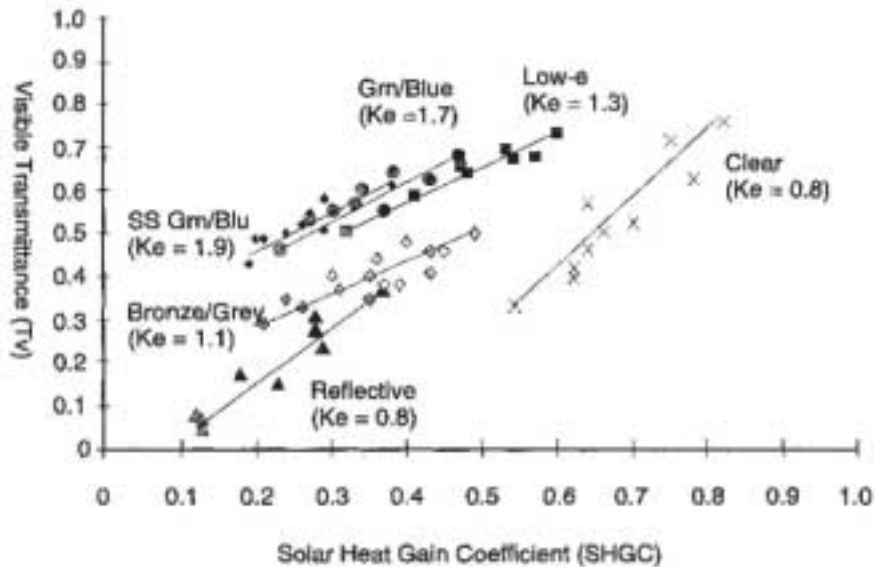

Visible Transmittance vs. SHGC for Various Glazing Types [Enermodal, 1995]

Balance window size with window properties. For daylighting purposes, in most cases, capital cost and energy consumption will be lower using smaller windows with high visible light transmission than using large tinted windows.

Glazing alone will not eliminate glare or solar heat gains. Exterior shading is the best strategy to avoid the entry of solar radiation into the space. Interior shading is also an option that can provide the occupant some control of the amount of incoming solar heat and sunlight. Heavily tinted or reflected glazings should be avoided.

Goal

To select external and internal devices to control sunlight entry and glare.

Fundamentals

Types of Shading

Exterior shading devices are more effective than interior shades at controlling solar gains. Unless direct sunlight can be diffused or reflected, it should be kept out of the building with exterior shading devices such as overhangs and awnings.

The following are examples of common exterior shading devices; all are variations of either the horizontal or the vertical overhang. The addition of louvers and fins can provide additional solar control.

Examples of Various Exterior Shading Devices



Standard Horizontal Overhang (HO)



HO, dropped edges for less projection



Louvers, instead of a solid dropped edge, to allow more light entry



HO, broken up for less projection



HO, sloped down for less projection



HO, louvers in place of solid overhang for more diffuse light



Vertical Louvers or fins



HO broken up for less projection

Shading and Visual Comfort

Interior shading is effective at minimizing uncomfortable glare from direct beams of light, but is not effective at solar heat gain minimization because it does not prevent the sun's heat from entering the space.

The following table compares the visible transmittance and the reduction in solar heat gain (SHGC) for various interior shading types and shade colour.

Visible Transmittance and SHGC for Interior Shades

Shading Type	% Visible Transmittance	% Reduction in SHGC
Venetian Blinds		
Light Colour	5	33
Dark Colour	5	29
Vertical blinds (closed)		
Light Colour	0	60
Dark Colour	0	18
Roller Shade		
Light translucent	25	54
Opaque, white	0	60
Opaque, dark	0	18
Draperies		
Shears	55	28
Closed weave, light	20	48
Closed weave, medium	12	39
Closed weave, dark	5	28

[Source: 1997 ASHRAE Handbook: Fundamentals]

Exterior Shading Techniques

Use exterior shading devices to control solar gains. Exterior shading devices are more effective than interior shades at controlling solar gains. Remember the goal is to shade direct sun but not daylight. Keep direct sunlight out of the building unless reflecting it up to the ceiling can diffuse it.

Use vegetation as seasonal shading devices. Careful placement of deciduous and evergreen trees and other vegetation can perform the function of external and internal shading devices. Deciduous trees and vines will provide shade only in the summer, whereas evergreens will provide shade all year-round. Vegetation on the east and west sides of a building are especially effective at providing protection from solar heat gain in the summer. Other benefits of vegetation include cooler ground temperatures, wind and sound barriers and a reduction of the "urban heat island" effect.

Shading and Visual Comfort

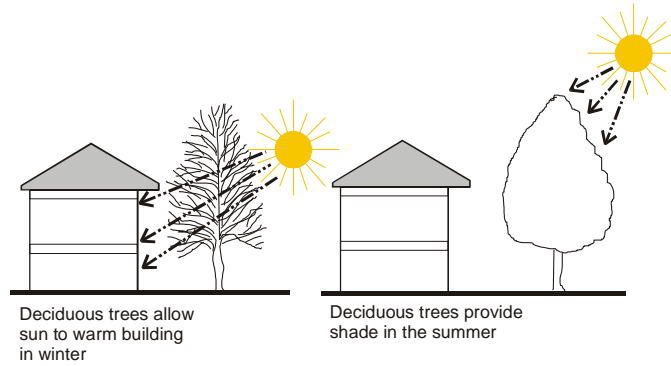

Effective use of Vegetation for Shading

Use screens to diffuse direct sunlight. Devices such as trees, trellises and screens can filter and soften sunlight. Screens are especially useful on east and west facades since they can diffuse low-angle direct sunshine.

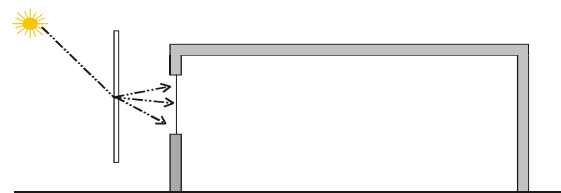

Use of Screens to Diffuse Lights

Paint overhangs white to reflect light. A white-coloured overhang will increase the amount of reflected light entering the building. Since the light bounces off a matte surface, it will be diffuse and not cause glare problems.

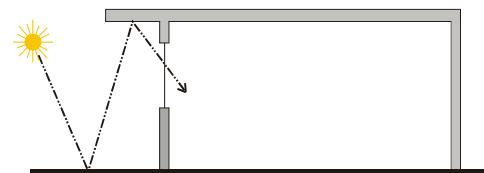

Overhang to Increase Light Diffusion

Use vertical or horizontal louvers to effectively block and diffuse direct sunlight. Louvers can block direct sunlight while reflecting and diffusing the light into the window. The louvers should be angled to prevent direct summer sunlight from entering the building and to shed snow in winter.

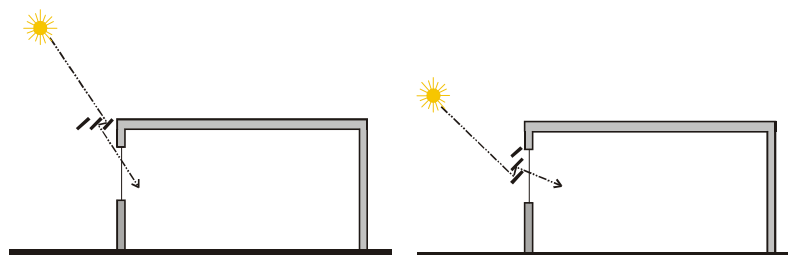

Vertical and Horizontal Louvers to Re-direct Sunlight

Use overhangs or awnings on south-facing windows. South, and to a lesser extent, east and west windows will benefit from horizontal shading devices. Examples include awnings, overhangs and recessed windows. North-facing windows generally don't require shading.

Use fins on east- and west-facing windows. Vertical fins on east and west windows can be effective at reducing direct solar radiation and glare between 9 AM and 3 PM—the warmest part of the day. As discussed previously, remember to minimize east- and especially west-facing windows.

Shading Strategy by Window Location

Window Orientation	Shading strategy
North	Usually not needed
South	Overhang, horizontal louvers, trellis over window
East/West	Vertical louvers, horizontal slats, deciduous trees

Use movable shading devices. Automated shading systems can adjust for daily and seasonal changes in sun position, thus making the shading more effective year round. However, these devices are expensive, so if cost is a limiting factor, then a fixed shading device is better than no device at all. Adjusting a shading device even only twice a year (in the spring and in the fall) can produce noticeable differences in the amount of useable sunlight delivered into the building.

Recess windows to provide shading. Set windows further into deep walls. As a result, the building will effectively shade itself, which is better than no exterior shading. Exterior shade screens in the window plane can be located in the recessed cavity if desired.



Recessed Shading Device

Interior Shading Techniques

Use interior shades and blinds to control glare. Effective interior treatments include venetian blinds with their slats upside-down and shades that pull up from the windowsill. Light shelves are also effective daylighting and shading devices. See the section “Daylighting the Perimeter” for more details about light shelves.

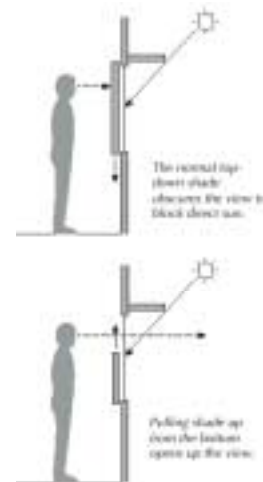

Glare Control with Effective use of Blinds

Keep blinds clean. Venetian blinds (or similar outdoor louvers) are one of the most effective glare reducing strategies. However, they are not as effective when covered with dirt or dust. Overcome this problem by positioning the blind between two layers of glass or have them cleaned as part of a regular maintenance program.

Use light coloured shades. A lighter coloured shade will result in a greater reduction in solar heat gain yet still permit some daylight penetration (see Table in Fundamentals). For effective glare control, a visible transmittance of 10% or less is advisable.

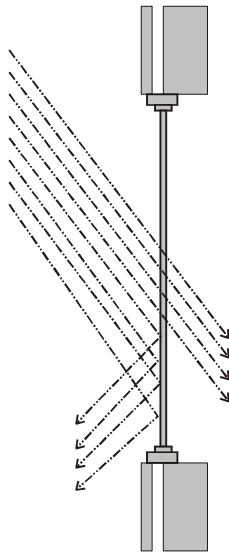

Mid-pane Venetian Blind

Overhang Size

Use the following chart to estimate the size of overhang required.

Latitude	D	G
43°	0.42*h	0.18*h
49°	0.56*h	0.18*h
53°	0.65*h	0.16*h
60°	0.81*h	0.09*h

The dimensions corresponding to D, G and h are illustrated in the figure below. The units of 'h' will determine the units of D and G.

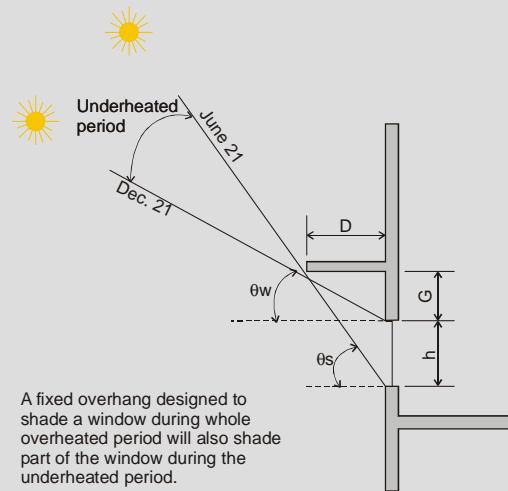

Fin Size

Fins should project out from the building the same distance as they are spaced between windows. Shortening the spacing between fins can reduce the fin projection.



Credit: CKCO Building, Waterloo, Ontario

PART 3 Daylighting Integration

Daylighting will not save any energy unless the building mechanical and lighting systems are modified to take advantage of the benefits of daylighting.



Integration of site, climate and building use enables a number of Canadian buildings to provide interior access to daylight



Credits: top left – National Renewable Energy Lab, Golden, CO; bottom left – YMCA Environmental Learning Centre, Paradise Lake, ON; middle right – Alice Turner Branch Library, Saskatoon, SK, Darlene Machibroda, Kindrachuk Agrey Architects Ltd.

Goal

To discuss using the Building Design Advisor (BDA) software to optimize the building form, envelope, and interior and exterior shading for daylighting.

Fundamentals

The previous sections have given guidelines and tips on incorporating daylighting with building design. By following these guidelines, the contribution of daylight to the lighting plan will increase and occupants will be more satisfied with their space. However, good daylighting design is complex and maximizing daylighting performance requires a more rigorous analysis of the specific building being designed.

The BDA computer program was specifically developed to analyze daylighting designs and the interaction of daylighting measures with building mechanical and lighting systems. BDA is used to predict the total energy usage, glare index and illumination levels of rooms within a building. The glare index relates the luminance from a light source (e.g. sunlight through a window) to that of the average illuminance of the room relative to the viewer's position. The limiting glare index in a room where detailed work is performed is low, about 10, whereas in a more casual work environment the limiting glare index is higher, closer to 25. BDA can be downloaded free-of-charge from: <http://gaia.lbl.gov/bda/index.html>.

The analysis is typically conducted for one or more representative rooms within a building. The user draws the reflected ceiling plan for each room to be assessed. Lighting and construction details can be selected from libraries of luminaires, glazing systems, control strategies and wall assemblies. BDA can determine

- spatial daylight and electric light illuminance (to assess the uniformity of lighting for a specified time of day on a specified month)
- temporal daylighting illuminance (to examine hourly illuminance levels for an average day in each month for the centre of the room as viewed from a specific orientation)
- spatial glare index (to evaluate the potential for glare throughout the room for one particular time as viewed from a specific orientation)
- temporal glare index (to assess the variability of glare over an average day for each month at the centre of the room)
- monthly and annual electric lighting savings for each room (to assess lighting savings from daylighting based on a specified visual activity)
- monthly and annual energy use for the building by end use (to examine the trade-off between heating, cooling and lighting energy)

Optimizing Daylighting Design With BDA

The user can optimize the daylighting by varying the size, type and placement of the glazings and luminaires. Window size can be optimized using the “*window_to_wall_ratio_sensitivity*” function. With this function, BDA calculates the total energy impact for a full range of window-to-wall ratios (*WWR*).

BDA is an integration of three different simulation tools and their associated databases. This linkage makes it possible to utilize the separate tools without having to redefine the same building parameters in each tool. The three tools are DCM (daylighting computation module), ECM (electric lighting computation module) and DOE-2 (energy analysis module). Note that the BDA User Manual also mentions a simulation tool called DElight, which is simply a combination of DCM and ECM. Although BDA is a powerful simulation tool, it does require several days to become familiar with the program interface and capabilities. A familiar user can perform a daylighting analysis of a simple room in 1 to 2 hours.

BDA is a Microsoft Windows® application that is similar in layout to Windows® Explorer. The BDA is made up of three main modules:

- The **Schematic Graphic Editor (SGE)** is used to draw the rooms (i.e., spaces) on each floor. The top of the SGE screen is always north and the bottom left hand corner of the space corresponds to the point (0,0) on spatial sensitivity graphs displayed in the Decision Desktop (see next page). Floors can be combined to create a building. Although practice is required, the SGE is relatively simple to use, as it doesn't require the knowledge of specialized CAD graphical drawing skills.

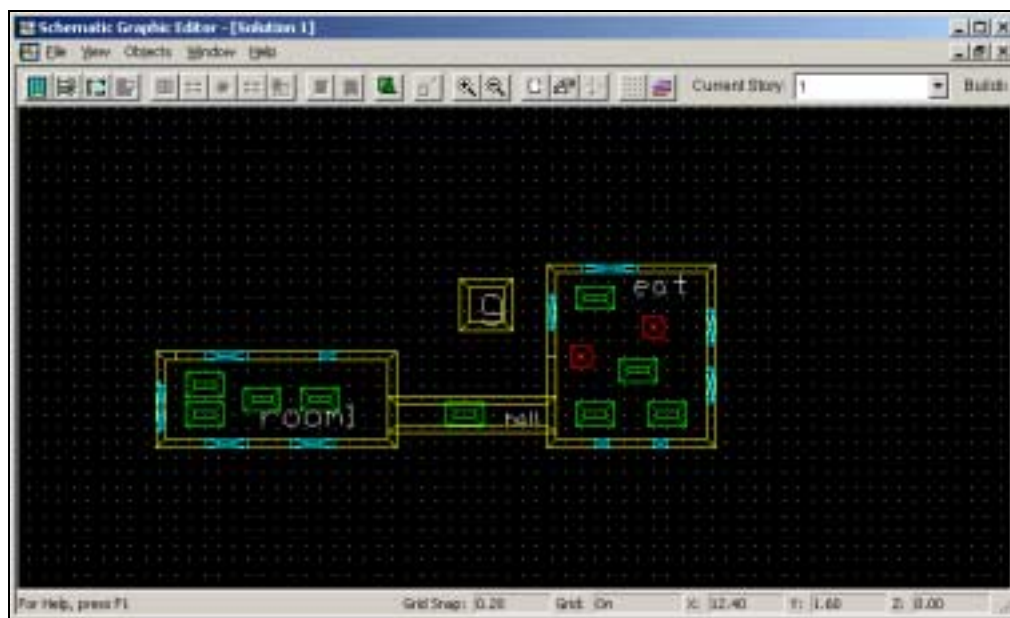

Optimizing Daylighting Design With BDA

- The **Building Browser** is the interface used to edit the values of the various building parameters and to select the desired performance parameters for calculation and display. The interface is easily navigated with some practice.

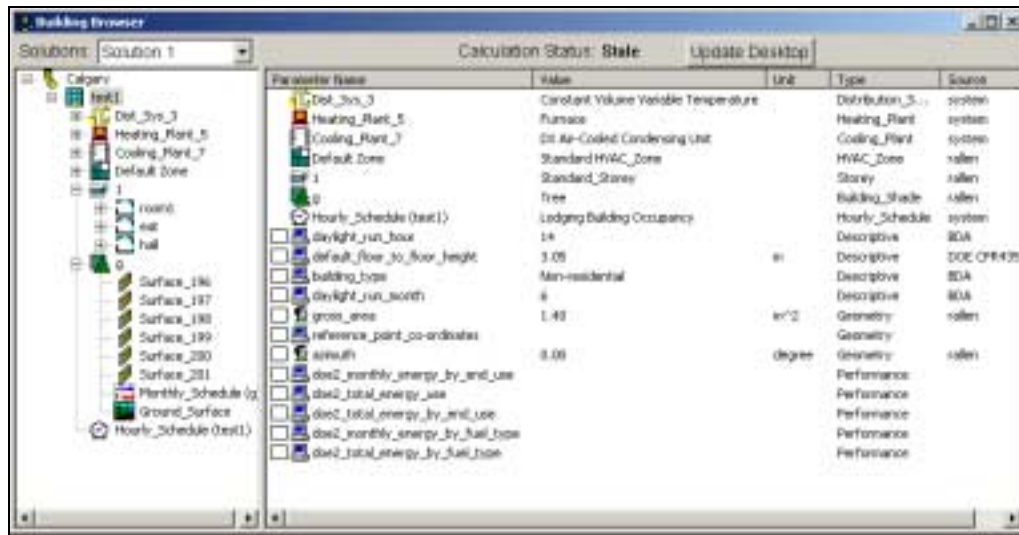

- The **Decision Desktop** displays calculation results. The Desktop shows graphs of illuminance, glare index and energy usage for the rooms and total building.

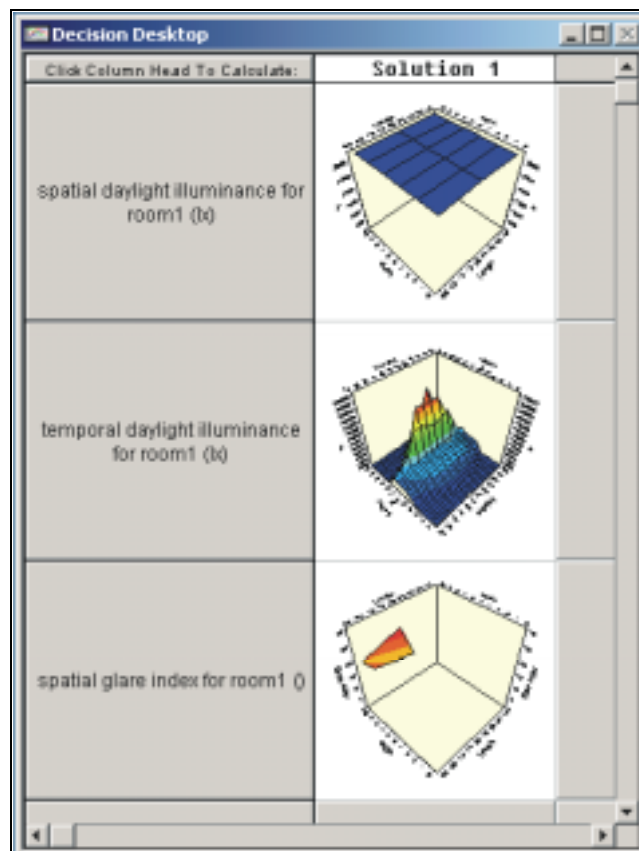

Limitations of BDA

Although the BDA interface is less technical and time consuming than that of most other building or energy simulation software, the program still requires that the user spend time acquainting themselves with the program. The meaning of some of the drawing and calculated parameters is not intuitive. At the current time, BDA is limited in the daylighting concepts that can be evaluated. These limitations include the following:

Geometric restrictions. Although BDA allows the user to draw non-rectangular spaces, the daylighting and electric lighting tools linked to BDA cannot model non-rectangular rooms.

Exterior shading device restrictions. The only available exterior shading devices that can be simulated in BDA are obstructions (e.g. trees), overhangs and fins. The impact of these shades on illuminance and glare cannot be determined. Light shelves and movable shades cannot be simulated.

Interior shading devices. Interior shading devices, such as curtains and blinds, cannot be simulated. The impact of closed shades can be estimated by lowering the glazing transmission properties but the dynamic impact of shades cannot be addressed.

Toplighting. Toplighting cannot be simulated.

Using the BDA Program

For the first time

Step 1: Read through the guidelines in the BDA Software User Manual. The manual provides guidance as to the techniques to use when making building component selections.

Step 2: Read any documented BDA problems and any supplementary tutorial information available through the Lawrence Berkeley National Laboratory (LBNL) web site.

Step 3: Work through the BDA tutorials. The BDA software package is a useful daylighting tool only if used correctly. The tutorials allow you to learn skills such as how to create a building space as well as how to use the New Solution feature of BDA.

Step 4: Become familiar with the BDA simulation functions. All of the BDA simulation output will be useful in building design analysis. Notice that the building schedules (i.e. hourly and monthly) can only be changed through the graphical interface of the Decision Desktop. It is also important to understand the reference points used in numerous BDA parameters. Unless otherwise positioned by the user, for calculation purposes the default location for a reference point is the centre of the space. Reference points are always located at the "workplane_height". This height can be changed through the Building Browser if required.

For a building simulation

Step 1: Assemble information on the building characteristics and system components. These parameters include building location and orientation, building spaces (and relative layout), and HVAC system requirements.

Step 2: Draw a typical room in the SGE and select the building characteristics from the libraries of walls, windows, shading objects, luminaries and lighting control type. Use BDA default values for some building components if the analysis is for daylighting considerations only. A parameter to consider changing is the “luminaire_suspension_length”. The BDA defaults for the HVAC systems as well as for the building occupancy are general enough for most business applications. Defaults only need changing if the building has significantly abnormal usage in these areas.

Step 3: Use the BDA “*window_to_wall_ratio_sensitivity*” function to determine the optimal Window to Wall Ratio (*WWR*) for the space. When this parameter is selected, BDA generates a plot that shows the relationship between effective aperture and the building’s energy requirements. It calculates the changes in energy consumption (lighting, heating, cooling) with changes in the ratio of window width and wall width at a space (i.e. room) level. The user can then determine whether the optimum window size lies with higher or lower effective apertures, and can adjust the building design accordingly.

Step 4: To see the effect of efforts that aim to minimize glare, run the “*temporal_glare_index*” sensitivity (measured over a single reference point), and the “*spatial_glare_index*” sensitivity (measured over a grid of reference points). Change the value of the “*occupant_orientation*” to assess the glare levels from various directions in the room. The results for the “*spatial_glare_index*” depend on the “*run_month*” and the “*run_hour*” parameters, which can be adjusted through the Building Browser.

Step 5: To see the effect of daylighting electric lighting, run the following four functions: “*spatial_daylight_illuminance*”, “*temporal_daylight_illuminance*”, “*spatial_electric_light_illuminance*”, and “*electric_light_illuminance*”. Change the “*workplan_height*” to best represent the height of the room occupant. The spatial illuminance is calculated at this height over the space at the *run_month* and *run_hour*.

Step 6: To see the effect of daylighting on electric lighting levels at a reference point run the “*doe2_ecm_annual_electric_lighting_savings*” sensitivity and the “*doe2_ecm_monthly_electric_lighting_savings*” sensitivity. For similar results based on average daylight illuminance over the whole space run the “*annual_electric_lighting_savings*” sensitivity and the “*monthly_electric_lighting_savings*” sensitivity. The lighting setpoint for all energy savings due to daylighting is the selected through the “*Visual_Activity*” parameter at the space level.

Step 7: After reviewing the results, vary window glazing and frame type, luminaire type and location, luminaire control (varying levels of user and automated control), and assess their impact on daylighting effectiveness. Experiment with overhangs, fins and building shades.

Step 8: If time permits, expand the analysis to other rooms or the whole building, especially if there are significant variations between rooms.

Typical BDA Analysis

A simulation of a one-room office to show the output of the window to wall ratio function was run. The function calculates the changes in energy consumption (lighting, heating, cooling) with changes in the ratio of window width and wall width. Three cases were run, the window glazing location and type being the sole variable between the cases.

The characteristics of the building are listed in the following table. The simulations are based on Ottawa, Ontario weather data.

Building Characteristic	Measurement
Window Sill height	1 m
Head Height	2.2 m
Wall Height	3 m
Room Depth	3.6 m
Room Width	2.6 m
Room Area	9.36 m ²
LPD (calculated)	13.0 W/m ²
Frame	Thermally Broken Aluminum
Lighting Control	Continuous Dimming
Luminaire Type	2 x TLS12 - Direct/Indirect, 61 Watt
Window Orientation	Case 1: North facing Cases 2 &3: South facing
Glazing Type	Cases 1 & 2: Two 1/8" panes of clear glass with ref. coating on the inside of the outer pane Case 3: Two 1/8" panes of glass with a bronze tint on the outside pane

An image of one of the rooms modeled (Case 1) as well as some examples of the simulation output are shown and described below. Little difference was seen in the results between cases 2 and 3, so only the results for case 1 (north-facing window) and case 2 (south-facing window) will be compared.

Optimizing Daylighting Design With BDA

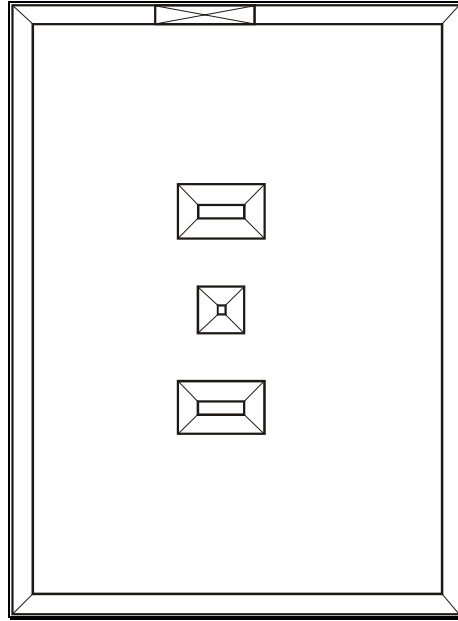

Office Space Modeled, North-facing Window

BDA can be used to estimate the optimal Window-to-wall ratio (*WWR*) for an office. For lighting (shown in yellow), the lowest point on the graph corresponds to the optimal *WWR* as this is the *WWR* that yields the lowest energy use.

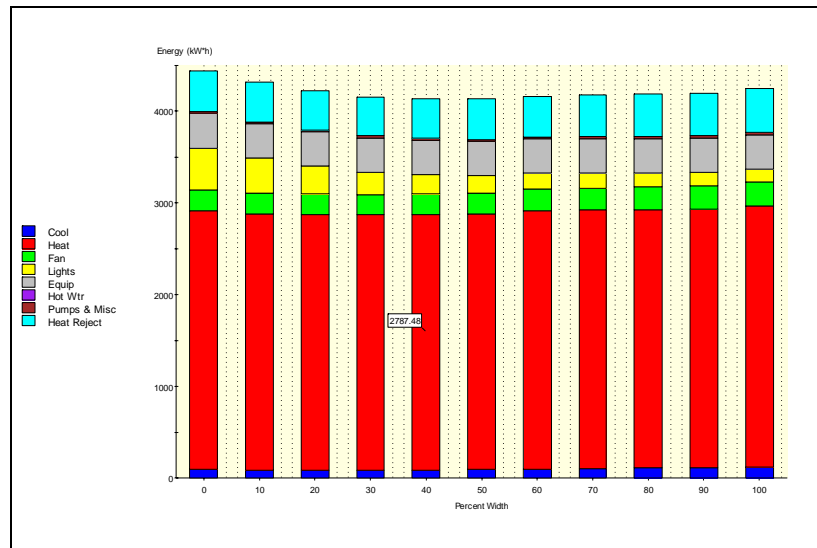

For the north-facing window, the optimal *WWR* is approximately 50%

Optimizing Daylighting Design With BDA

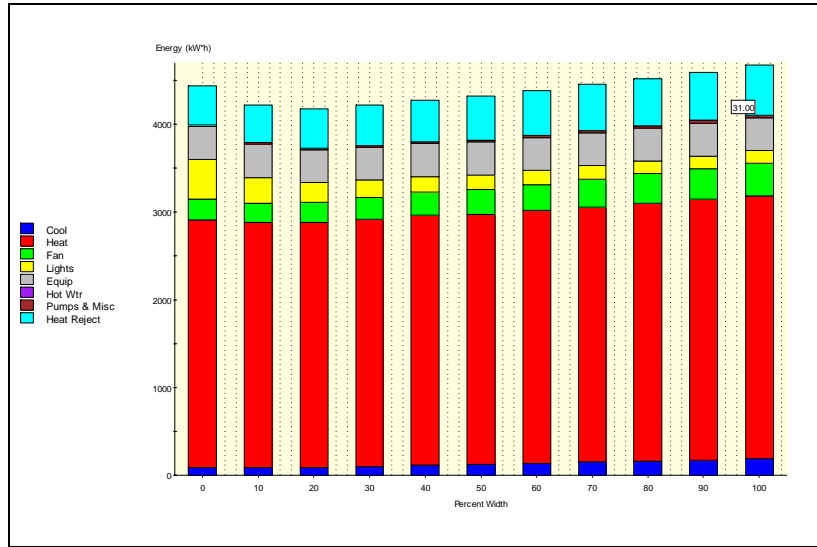

For both south-facing windows, 10 to 20% WWR yields the lowest energy use

BDA can be used to estimate how much supplementary electric lighting to install in a similarly arranged office, based on typical daylight availability for the geographic location. The diagram below shows illumination (in lux) vs. hours of the day (for a 24 period) over a year (in months). It can be seen by the colour index that daylight will provide ample lighting during the middle of the day, especially during the summer months. However, in the evenings and during the winter months, electric lights will be required.

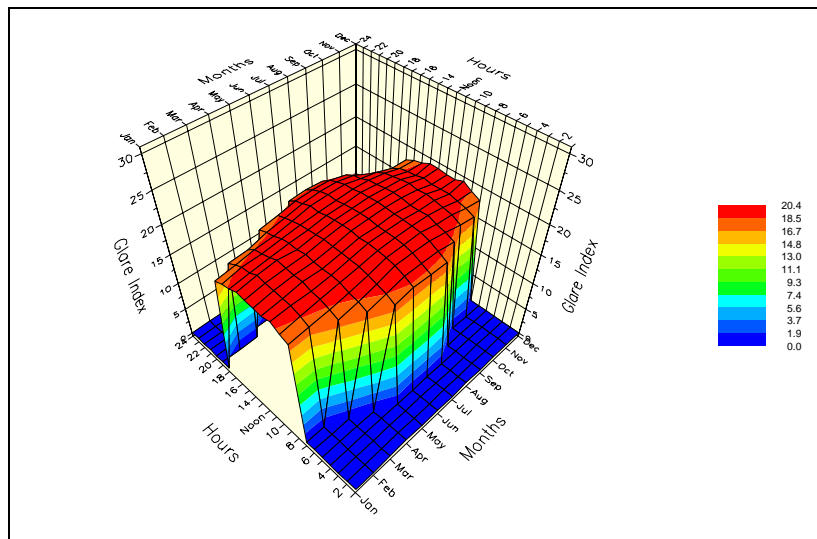

Temporal Daylight Illuminance for the North-facing Window

Optimizing Daylighting Design With BDA

Percent reductions in the cost of electrically lighting for a space can also be compared in the BDA. The south-facing window offers more light saving opportunities over a year during the summer months (later into the day) and during the winter months (during the middle of the day).

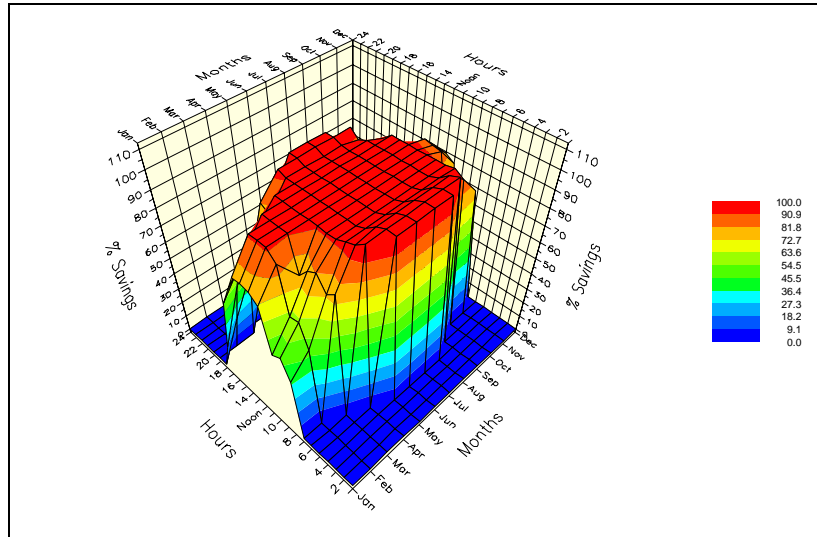

Monthly Electric Lighting Savings, North-facing Window

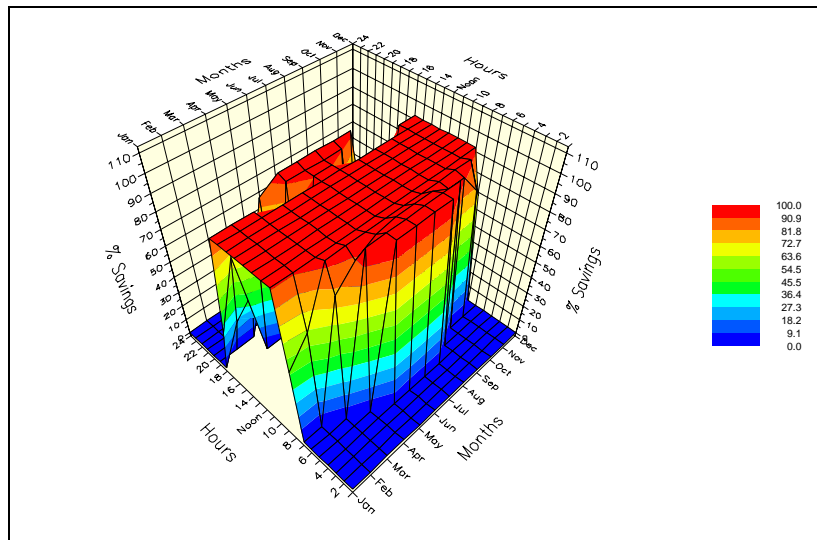

Monthly Electric Lighting Savings, South-facing Window

Goal

To adjust the size, type and location of the HVAC system to take advantage of the windows and daylighting systems.

Fundamentals

This guide has presented many techniques to increase window performance and daylighting opportunities. When implemented, these techniques will result in lower heating and cooling loads:

- lower internal gains due to dimmed electric lighting will reduce the required cooling energy
- energy-efficient windows will result in lower peak heating and cooling loads
- cooling peak loads will also be reduced due to improved window shading

Bulky mechanical systems need to be modified and downsized to take advantage of these loads. These capacity reductions will be reflected in smaller mechanical systems, reducing both the building space required by the systems as well as the capital cost of the equipment. If the loads are small enough, heating/cooling terminals need not be located at the perimeter. Lower annual operating costs should also be expected. The table below provides an estimate of the type of HVAC cost savings that are achievable by downsizing the system.

HVAC Cost Savings with Daylighting Integration

System	Estimated Capital Cost Credit
Heating System (boiler, piping, radiators, etc.)	\$11/MBH or \$37/kW
Cooling System (chiller, piping, ducting)	\$500/ton or \$144/kW
Air Handler	\$5/CFM or \$10.50/L/s

Techniques

Use an integrated design team approach to optimize the building system. By working together, the building architect(s), mechanical engineer(s) and others can optimize the design of building components. The team should work together to fine tune window size, window location, shading strategies and glazing selection in order to have a smaller and more efficient HVAC system. For example, the architect may select a glazing that has cooling benefits. Similarly, the mechanical team may identify architectural elements of the building that present an opportunity to downsize the cooling system.

Downsize the HVAC system serving daylit areas. The mechanical systems should be sized based on the peak energy requirements of a building accounting for reduced perimeter heating, cooling and lighting loads due to daylighting. The calculation peak heating loads should account for the lower window U-value. The calculation of peak cooling load should account for dimmed lights in daylit areas and lower solar gains

Use high performance windows to eliminate the need for perimeter heating. Cold glass temperature increases radiative heat transfer from the occupants and causes asymmetric radiation (high heat transfer on one side of the body and low on the other). Also, the cold glass temperature causes the air adjacent to the window to cool and convect into the room. This is often mistaken for a drafty window.

If low-heat-loss windows are used, radiative and convective heat losses are reduced and perimeter heating can be eliminated. The required window performance to eliminate perimeter heating is tabulated below for a maximum 20% *WWR*. Better performing windows or perimeter heating may still be required for larger *WWR* and in northern locations. The incremental cost of improved windows can often be recovered by savings on mechanical equipment.

Required Window Performance to Eliminate Perimeter Heating

Heating Design Temp (°C)	Window Type & U-value (W/(m ² °C))	Location
> -14 °C	Double-glazed low-e < 2.3	Vancouver, Victoria
-14 to -24 °C	Energy-Efficient ^a < 2.0	Southern BC, ON & QC
< -24 °C	Super Energy-Efficient ^b < 1.5	Northern BC, ON & QC, Prairies

^a double-glazed low-e, argon in an insulating frame

^b triple glazed low-e, argon and an insulating frame

Mechanical Coordination



Approximately half the incremental cost of using high-performance windows was recovered by savings in eliminating perimeter radiation for an apartment building in Dundas, Ontario

Credit: Enermodal Engineering Ltd.

Goal

To design and control the lighting system to take advantage of daylight opportunities.

Fundamentals

The lighting designer must ensure that the occupants of the building will be satisfied with the lighting levels and lighting control systems. Occupants will disable a system they find unsatisfactory. To avoid negative reaction to the daylighting measures, the following guidelines should be met:

- Don't compromise lighting quality for energy efficiency. Each area must be lit according to the tasks performed for user comfort and skill. In some cases, safety concerns with under-lit areas may also arise.
- Ensure that the lighting control system meets user needs and that it is operating properly. Unpredictable or poorly functioning controls are a major source of occupant frustration.
- Occupants generally want to feel that they have control over their workspace. Provide the opportunity for manual override and place manual controls in convenient and visible locations.

The key element for daylighting integration is the electric light system.

The lighting should provide the following functions (in order of importance):

- **Scheduling** Lights are turned on and off according to the day/night/holiday schedule of the whole building zone. This can be accomplished with a Building Automation System or occupancy sensors for each office.
- **Daylighting** Lights are dimmed or shut off in response to interior daylight levels.
- **Tuning** Lighting levels are fine-tuned to the desired illumination once the building is occupied. This may save 10 to 15% of the lighting energy.
- **Lumen maintenance** Using the same hardware for daylight dimming, new lamps are dimmed until their light output is at the design level. As the lamps age or become dirty, the power input is increased to maintain the desired illumination. The same hardware as for daylight dimming is used. Annual lighting savings of 10 to 15% are typically achieved with lumen maintenance.

Three types of lighting control strategies are used in daylight buildings:

Auxiliary Lighting Integration

On/off control. Lights are turned on or off in response to the indoor illumination level. This is the simplest control, but also has the greatest fluctuation in lighting level. This control is best suited to rooms that can accept a wide variation in light levels: entrances, atria and cafeterias.

Staged or switching controls. This control switches off successive rows of lamps or fixtures using simple relay switches as the daylight level increases. The switching can be individual lamps in a multi-lamp fixture or alternating fixtures in a grid light pattern. This type of control is best suited to corridors and rooms where fine work is not being done.

Dimming controls. The lamps are dimmed as the daylight increases. These are more expensive, requiring special lamps and ballasts and more elaborate controls. Increased energy savings can usually be achieved with a well-designed set up. The control is best suited to offices. Results and savings are highly sensitive to sensor placement, hardware quality and commissioning.

Typical Cost of Lighting Control Sensors

Control	Material	Installation	Commissioning
Daylight Sensor	\$80	\$40	\$20
Occupancy Sensor	\$80	\$40	\$10
DS/OS	\$100	\$50	\$25

Techniques

Type and Location of Light Fixtures

Design the lighting system for daylighting from the start. Use the established building daylighting goals as a basis for the building lighting strategy, light fixture selection and control methods. If well planned, electric lighting can be used effectively to augment daylight present in the building spaces. In other words, daylight would be considered as the prime source of light, with artificial lighting as the backup.

Use task lighting for fine detail work.

Although daylight will usually be sufficient for ambient lighting, user-controlled, task-specific lighting should be available for fine detail work or to highlight certain areas.

Keep ambient lighting low when computer screens are present.

Ambient lighting levels should be low in areas with VDTs to reduce glare on



Use Task Lighting for Fine Detail Work

Credit: Enermodal Engineering Ltd.

Auxiliary Lighting Integration

screens. A rule of thumb is to provide ambient lighting of 200 to 300 lux for spaces with VDTs and 500 lux or above for adjacent non-VDT tasks.

Keep exposed bulbs out of the field of view. An exposed bulb is a distraction and causes glare. A diffuse light works best with daylighting systems. Direct/indirect lighting is an option. Careful space planning will also prevent field of view glare.

Use direct/indirect lighting when supplementary illumination is required. In order to match daylight distribution and to avoid glare, use direct/indirect lighting. Indirect lighting does not produce the common problem of lamp reflectance on computer screens. Ceilings should be reflective and have a height of at least 2.4 m. If the ceiling is less than 2.4 m, don't use a pendant-style direct/indirect lighting system. Lights placed at least 0.3 m from the ceiling will provide the best light distribution.



Direct/indirect Lighting Distribution

Avoid parabolic light fixtures for ambient lighting. Parabolic fixtures direct light straight down with little lighting spread. This increases the quantity of fixtures required for a given space. Direct/indirect lighting as discussed above is preferred.

Provide additional lighting in deep (greater than 4.5 metre) rooms. If deep rooms cannot be avoided, provide vertical illumination on the back wall to balance illumination contrasts with the front of the room. Ceiling lights within 0.6 metres of the wall or wallwashers with a cool colour temperature greater than 4000 K are examples of suitable lights. Walls and partitions should be light coloured with matte finished surfaces, especially those surrounding windows.

Use energy-efficient 32-Watt T8 or 28-Watt T5 tri-phosphor fluorescent lamps and dimming ballasts. Fluorescent lighting is the most appropriate source of lighting for dimming and switching applications. It provides a wide dimming range at a uniform color and can be turned on and off almost instantaneously. Most dimming fluorescent ballasts dim to 10 to 20% light output (at 30% power), but some premium cost dimmers can dim to 1%. Avoid 34-Watt T12 lamps as they do not dim reliably.

Use lamps with a colour temperature of 4100K. A lighting colour temperature of 4100 K will best match the colour of daylight. The minimum lighting colour temperature is 3500 K.

Zoning

Arrange light fixtures in zones with similar daylight availability and space function. For open areas with continuous strip windows arrange the lights in rows parallel to the window. A separate control system should be installed for each row. For individual (punched) or widely spaced windows, group lights with

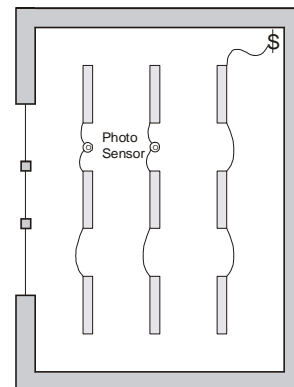

Effective Lighting Control with Lights Arranged Parallel to Windows

each window. For effective control and occupant comfort, the shading devices need to correspond to control zones. In long zones, it is desirable to have multiple sensors connected in parallel to minimize false operation due to misuse of blinds by some occupants.

Arrange light fixtures in zones even if daylighting controls are not immediately planned. This will allow daylighting retrofits to be implemented with more ease in the future. Advances in dimming and ballast control technology are making lighting retrofits increasingly possible.

Limit the number of zones where possible. The control system will increase in cost with each install control point, but the zones should not get so large that lighting efficiency and effectiveness are diminished. Each individual office space will require one control; multiple offices in open-plan offices can be controlled with one sensor.

Lighting Control

Define an appropriate lighting control strategy for each lighting zone. Decide whether the zone lights should be controlled by occupancy sensors, daylight sensors, time scheduler or a combination of the above.

Use dimming control for daylighting, lumen maintenance or tuning control strategies.

Although dimming control strategies are expensive (at least twice as costly as switching controls) it is the best method to implement. Also, space occupants generally prefer them, as changes in electric light level are less dramatic. Dimming will not be cost-effective in non-daylight areas unless it is coupled with scheduling controls.

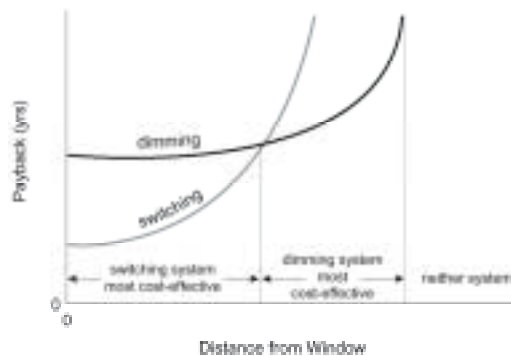

Dimming/Switching Payback

[Source: LBNL "Tips for Daylighting With Windows"]

Use on/off switching controls where changes in light levels are acceptable.

Switching controls will result in abrupt (on/off) light level changes so are most applicable in areas that will receive sufficient daylight all day long and for non-critical tasks (e.g. corridors, atria). On/off switching should not be used in offices. This is disruptive to the occupant and will likely result in the occupant disabling the control system. Sufficient light is usually available in zones that are less than 4.5 metres deep from large windows (if the weather is not predominantly cloudy).

Use staged or dual-level switching as a compromise between dimming and on/off switching.

Dual-level or multi-level switching can be activated by daylight and occupancy sensors at less cost than dimming, but will provide better occupant acceptance than the simpler on/off controls.

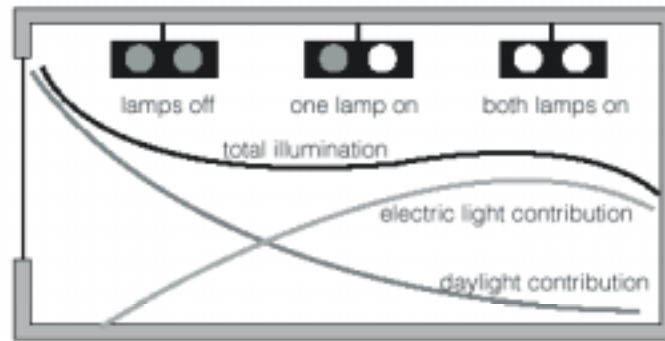

Lighting Levels in a Room with Staged Lighting Controls

Use programmable time controls over simple timeclocks. If the building has multiple daily schedules, programmable controls (with manual override) can yield increased energy savings. For example, sweep-off control, in which all lights are automatically turned off after building closing time, will turn off any forgotten lights and will result in approximately 15% energy savings.

Use occupancy sensors. These sensors are easily installed, yield approximately 15 to 30% energy savings and are very cost-effective. Ensure they are installed in a location that will provide an unobstructed view of the space. It is possible to purchase integrated daylight and occupancy sensors. Sensors are routinely shipped to contractors at minimum setting that, if retained, will cause light to cycle rapidly and sensitivity to be almost non-existent.

Choose manual-on/automatic-off occupancy sensors. Occupants often forget to turn lights off when leaving a room. Occupancy sensors will ensure that the lights are off when the space is empty after a set time interval. The occupant can over-ride the control to turn the lights off but cannot over-ride the control to keep the lights on when they are not in the room.

Daylight Control Algorithm

Decide between open or closed loop control algorithms. Closed-loop systems are those in which information is fed back to the system to achieve control objectives. This information feedback does not occur in open-loop systems. For this reason, open-loop systems cannot compensate for electric light losses (i.e. the lumen maintenance strategy). However, they can be more easily calibrated than most closed-loop systems and are more forgiving to errors in sensor placement. Closed-loop systems that work with daylight may cause electric light levels to drop below desired light levels if they receive interference (e.g. placed too close to a window) or patches of bright light from indirect lighting.

For on/off switching systems, the time delay and setpoint deadband should be independently adjustable. Variable cloud conditions will cause system oscillations between on and off if the time delay or setpoint deadband are improperly set. The light level at which the devices switches off should be at least twice the level at which it switches on to ensure that the design illuminance is met at all times.

The response time to sudden daylight changes should be slow. To avoid unnecessary dimming response to temporary daylight conditions (such as moving clouds), the dimming response time should be set to about 30 seconds.

Sensor Location

Place the daylight sensor in a location appropriate to the task. In a room with only one task area, a ceiling-mounted sensor placed above the task will likely be most effective. In a room with multiple task areas, the most representative location should be chosen. However, if the controller will accept multiple inputs, then sample the daylight from multiple locations.

Place the sensor in a position appropriate for the chosen control algorithm. For closed-loop systems, place the sensor approximately two-thirds into the depth of the daylight control zone. For open-loop systems the photosensor location is less critical and can be optimized during commissioning. However, if a light shelf is being used with an open-loop control system, the sensor should be placed above the shelf, not on or below it.

Set the sensor placement according to the type of lighting system. With indirect and indirect/direct lightings systems the photosensor should be placed in the plane of the fixtures. Care must be taken to ensure they do not have a view of the electric lights they control. For direct lighting systems, the photosensor should be recessed into the ceiling.

Optimize the sensor field of view. Ceiling-mounted closed loop sensors should have a large field of view and should be shielded from direct light from the windows. Sun shields are an option if the sensor cannot be placed far enough from the window. For switching systems, locate a photosensor such that it views external daylight but not the electric light that it controls.

Goal

To ensure that the installed lighting control systems function as intended before and after the building is occupied.

Fundamentals

Proper calibration, commissioning and maintenance are essential for the successful operation of a building from both a technical and an occupant satisfaction point of view. Only if the equipment is operating correctly can it provide anticipated lighting levels, energy savings, user satisfaction and cost effectiveness. Any problems identified during the installation of the auxiliary lighting or mechanical systems should be recorded for examination during this phase. An additional benefit of commissioning is that it can be a useful training period for operation and maintenance staff. This staff should ensure the equipment is checked on an annual basis.

There are three reasons for commissioning:

- To calibrate the system and to identify and correct any installation errors or malfunctions
- To establish the response of the system to provide the appropriate lighting conditions for each lighting zone
- To optimize the performance for site-specific conditions. Daylight levels are different from site to site and so cannot be optimized for each location during sensor manufacturing

All elements of the daylighting system should be commissioned. Although this section focuses on photocell sensor calibration, HVAC controls as well as other sensors such as occupancy sensors, should also be commissioned. Do not forget to commission any automated shading devices. For all devices follow manufacturer calibration instructions.

Techniques

Commissioning Procedures

Coordinate the commissioning with completion of the interior furnishing. Commissioning will be more effective with the furniture, etc. in place. However, if this is not possible, fine-tuning can be done later, once furnishings are complete. If interior decoration is changed, the photosensors will need to be checked and likely fine-tuned (recalibrated).

Calibrate fluorescent lamps for lumen maintenance and light output. Lamps should be on for about 100 hours at full light output in order to ensure stable lamp operation. Adjust the light output at night or with the blinds closed to deliver the design light illumination.

Commissioning and Maintenance

Calibrate daylight systems during the day. Select a time when the sun is shining and cloud conditions are typical for the region. Be sure the sunlight levels allow the dimming or switching controls to be tested (i.e. Daylight should not provide sufficient light to completely dim the lights.). Adjust the daylight sensors so the electric lights dim to deliver the desired illumination. Sensors are routinely shipped from the manufacturer with the sensitivity at the minimum setting. If this setting is retained, the lights will cycle rapidly and cause occupant dissatisfaction.

Calibrate each zone separately using an appropriate region of the zone. Within each zone select a location, or “stationpoint”, that has daylight and electrical light conditions typical of the entire zone. Large zones (i.e. over 65 m²) may require more than one stationpoint. If a space receives light from an adjacent zone, it may be necessary to recalibrate the lighting in this space after the adjacent zone lighting has been calibrated.

Always follow manufacturers instructions. The suggestions listed here are general and manufacturers instructions should supersede any conflicting instructions.

Educate occupants and building operators on design of system. Occupants and building operators will disable and over-ride a system they do not understand. The design and operation of the system should be explained to the occupants and building operators.



The daylighting control system for this plant was commissioned to ensure proper response to daylight through the north-facing skylights.

Credit: Enermodal Engineering Ltd.

Maintenance Procedures

A proper maintenance plan is important to ensure the intended lighting quality and quantity are maintained throughout the life of the system. Improper or lack of maintenance of these systems can have a negative effect on human performance, perception of an area, safety, security and energy efficiency.

A proper maintenance program should consist of the following actions on a scheduled basis:

- Group re-lamp
- Clean lamps and luminaries
- Re-calibrate daylighting controls once a year
- Replace defective or broken components
- Maintain room's surface properties when painting

PART 4 Case Studies

Introduction

Three award winning buildings will be presented in this section: Green on the Grand, the Surrey Tax Centre, and the Yukon Energy Corporation building (YEC).

Although similar in daylighting design principles, there are some notable differences in both daylighting implementations as well as building use. For example the Green on the Grand and the Surrey Tax Centre are both multi-tenant buildings, whereas the YEC building is an owner-occupied building. Effective implementation of many of the techniques discussed in this Daylighting Guide has lead to the results discussed below.



*Credits: top left – -Green on the Grand, Kitchener, ON, Joel Bowey, Enermodal Engineering Ltd.;
bottom left – Surrey Tax Centre, Surrey, BC, Busby and Associates Architects Ltd.; middle right –
Yukon Energy Corporation, Whitehorse, YK, Bill Haydock.*

Green on the Grand, Kitchener, Ontario



Green on the Grand Office Building

Credit: Enermodal Engineering Ltd.

Design Basis

The Green on the Grand office building is the first C-2000 building in Canada. C-2000 is a Natural Resources Canada program that requires buildings to have superior performance in four key areas: energy-efficiency, minimal environmental impact, occupant health and comfort, and functional performance.

As built, the building represents a 42% reduction in annual energy cost when compared to the same building but designed with the ASHRAE 90.1 energy efficiency measures. Approximately 20% of the energy consumption is due to electric lighting requirements.

Orientation and Form

The building is two storeys with a floor area of 2190 m² (interior dimensions). The building shape of two offset rectangles maximizes daylight penetration into the building and gives most offices views of the Grand River. The building lot is in the north-south direction, however, which limits southern exposures and increases west and east-facing facades.

The building is low-rise (in keeping with surrounding buildings). Each of the five tenants have office space that is 15 m wide, which can accommodate two 3.7 m perimeter offices, two 1.2 m corridors and two 2.4 m interior workstations.

The windows and doors at Green on the Grand are designed to have low heat loss, high daylight transmission and low solar heat gain.

Perimeter Daylighting

There are windows on each of the four facades with the goal of providing adequate light to perimeter offices. Windows were placed at desk height to maximize daylighting. Using energy simulations it was determined that a window to wall ratio of 30% minimized the total building energy cost.

The perimeter windows are a mix of fixed and awning type punched windows. The awning type windows are operable to allow the occupants to control outdoor airflow.

Large glazed entrance ways on the north and south sides daylight the first floor corridors. The second floor landing is also daylit from the south-side entrance.

To provide even light distribution to the daylit perimeter offices, the rooms are painted a light colour to help reflect light to the back of the room. Windows in each office are placed high on the walls to help natural light reach deeper into the room. Blinds with horizontal slats upside down were installed to reflect light into the rear areas of the perimeter offices. This was done to reduce lighting contrasts between the front and the back of the offices. Fabric blinds are also used, as they allow daylight transmittance, but reduce glare.

Core Daylighting

The second floor interior features cathedral ceilings. Eight dormer windows light the interior of the second floor (two facing in each of the four cardinal directions). The dormer windows provide ambient lighting; task lighting is installed in each workspace where required.

Daylight also spills over to the interior from the perimeter offices through glass transoms installed in the separating wall.

Glazing and Selection

The Green on the Grand windows were carefully selected for low heat loss, high daylight transmission and low solar heat gain. The windows are triple-glazed in insulated fiberglass frames with two low-e coatings, two argon gas-fills and two silicone edge-spacers—the total U-value is under $1.0 \text{ W/m}^2\text{C}$. The glazing system incorporates an outside lite of spectrally selective glass to achieve a high visible transmission and low SHGC.



Interior Offices Lit by Dormer Windows

Thermal Properties of Windows

Property	Center Glazing	Total Window	
		Fixed	Awning
U-value (W/m ² K)	0.78	0.93	1.07
SHGC	0.28	0.24	0.19
Visible Transmission	0.53	0.45	0.36

Shading and Visual Comfort

The building’s pitched roof has extra wide eaves that extend to provide an overhang for the top storey windows. Deciduous trees are used to shade east and west-facing windows.

Summertime shading is provided by fabric roller-blinds and horizontal blinds with upside down slats that reflect light into the building interior.

Auxiliary Lighting

Most light fixtures have efficient electronic dimmable ballasts with fluorescent T8 lamps in indirect/direct lighting fixtures. The installed lighting power is 50% lower than that typically used in offices.

The lights are controlled by motion and daylighting sensors. A modulating dimming system controls the lights in all perimeter offices, with the exception of a few on the north side, as well as central areas on the second story.

The parking lot is lit using energy-efficient, high-pressure sodium lights. Motion sensors control exterior security lighting.



Fluorescent Lights with Electronic Ballasts

Mechanical Coordination

The building is conditioned with radiant heating and cooling panels (rather than forced air systems) to achieve greater energy efficiency, lower motor power, superior occupant comfort, and zone temperature control.

Low heating and cooling loads mean that the panels are only required to cover 30% of the building ceiling area.

The water-based radiator system with radiant panels on the ceiling carry hot water in the winter and cold water in the summer. The panels are operated at about 35°C in the winter and about 13°C in the summer.

The water is heated or cooled using a natural-gas-fired combination boiler/absorption chiller.

During the summer, the gas-fired chiller is less expensive to operate than an electrical air-conditioning system and does not contribute to peak electricity demand.

Dehumidifying ventilation air eliminates condensation on radiant panels.

The storm water retention pond (20 m X 10 m X 0.9 m deep) also acts as a cooling tower for the chiller. Waste heat is rejected to the pond where it is dissipated by evaporation. A waterfall increases effective pond surface area and evaporation.

Fan coils in entranceways provide heating and cooling for these high heat loss/gain areas.



Radiant Heating and Cooling Panels

The pumps as installed at Green on the Grand operate at 57% efficiency and the motors at 72% efficiency, for a combined efficiency of 41%.

Commissioning

In a survey of the building occupants (in which 70% of the occupants participated), it was seen that over 80% of the tenants were satisfied with general environment and lighting in their office. Lighting problems arose when only one photosensor controlled several offices. These problems are easily avoided by placing a sensor in each room, although a cost increase would be incurred.

The two sources of dissatisfaction were noise and temperature [Enermodal, 1998]. Temperature dissatisfactions were likely partly a function of the time of year of the survey (a swing period). Noise levels are likely due to the hard surfaces of both the radiant heating and cooling panels and the linoleum flooring and a lack of masking noise from an air heating system.

Surrey Tax Centre, Surrey, BC



The Revenue Canada Burnaby-Fraser Tax Services Building

Credit: Busby and Associates Architects Ltd.

Design Basis

The Revenue Canada Burnaby-Fraser Tax Services Building in Surrey, BC (other wise known as the Surrey Tax Centre) was developed through a 1997 PWC Design/Build competition. As such, the building was designed to be an “advanced building office” within an office building capital budget.

The highly energy-efficient building has an annual operating energy consumption of approximately 634 MJ/m², which is 12% lower than the ASHRAE reference building.

This building is the recipient of a number of important awards, which include the following:

- 2000 Lieutenant Governor of BC, Award of Excellence, 2000
- Governor General's Award of Merit, 1999
- BC Chapter of the Project Management Institute (PMI) Project of the Year, 1999
- PMI BOMA Earth Award, 1999
- VRCA Award of Excellence, 1999
- Energy User News Efficient Buildings Award (First Place), Atlanta Conference, 1999
- 1998 International Green Building Challenge, 1998

Advanced building design techniques were aimed at increasing employee comfort, workspace flexibility, and energy sustainability.

Orientation and Form

The five-storey office building emphasizes the use of daylighting with a staggered floor plan. This plan maximizes the building perimeter and provides daylight access to almost all office areas; 90% of the work-stations are within 8 m of glazing and natural light. The useable floor area is 10,025m², with a net useable-to-gross floor area ratio of 81%.



Schematic of Building Layout

Perimeter and Core Daylighting

Perimeter and core daylighting is provided through the use of light shelves in conjunction with high building ceilings (95% of the floor area has a 3 metre clear height). This increases the penetration of natural light while reducing glare. Consequently, the light shelves help to reduce building solar heat gain, resulting in lower building operating costs.

A direct/indirect lighting system is integrated with daylight from light shelves and large areas of low-e glazing.



Daylight Access is Abundant Thanks to Careful Window Plan

Credit: Busby and Associates Architects Ltd.

Glazing and Selection

The building skin is primarily double-glazed, clear low-e glass with five different elements for each floor level, which include from top to bottom:

- A clear panel to allow daylight penetration to the light shelf
- Two clear panels with projecting sunshades, the lower of the two is operable to provide natural ventilation
- Two spandrels in two tones of glass soften the overall elevation. The spandrel panels all have a thermal resistance of RSI 3.52 or better.

Shading and Visual Comfort

An exterior wall enclosure system incorporates elegant curved-glass sunscreens that cut glare and reflect natural light into the building.



Suncreens Provide Effective Glare Control

Credit: Busby and Associates Architects Ltd.

Auxiliary Lighting

The lighting system is an overhead, indirect type, controlled by daylight sensors in the perimeter zones.

Mechanical Coordination

The building has a mixed-mode ventilation system, with both operable windows and a mechanical system providing displacement ventilation. The system provides free cooling for longer periods than a traditional system.

Operable windows and the absence of conventional dropped ceilings give all employees access to natural light and ventilation in high (over 3 m) ceiling spaces.

Most of the building servicing is placed in access flooring, a key element in providing cost effective HVAC flexibility for tenant relocation. A pressurized floor plenum system is used to distribute fresh air as necessary and further enhances employees' control of their work environment. Occupants can control the location and airflow of air diffusers at each workstation.

Yukon Energy Corporation, Whitehorse, Yukon



Yukon Energy Corporation Building

Credit: Bill Haydock, Yukon Energy Corporation

Design Basis

Located in Whitehorse, Yukon, the corporate office building for the Yukon Energy Corporation is the first building north of 60° latitude to be designed under the C-2000 program. This building was a recipient of the 1999 National Energy Efficiency Award and a participant in the Commercial Buildings Incentive Program (CBIP) for energy efficiency. According to the designers, the completed building provides a 42% annual energy cost saving of \$16,985. Innovative building configuration, site orientation, building HVAC systems and 'intelligent' envelope construction make these savings possible. In accordance with the experiences and premises of C-2000, the building was the result of a process of fully integrated design supported by intensive DOE-2.1e energy simulation.

Orientation and Form

The building is two-storeys with a partial third floor. The owner-occupied office includes some supplementary support areas, such as a monitoring station for site dam and spillway facilities. (The building was designed for use as a combined office and hydro-electric generating control facility.)

The southward facing boomerang-shaped building has a gross floor area of 1,200 m² with a floor plan that provides an appropriate view of the nearby switchyard, dam spillway and gates. The layout provides a balance between daylighting, solar gain, and management of HVAC load peaks and profiles. An efficient volume-to-floor ratio reduces construction material

requirements while offering improved energy efficiency through reduced external envelope and lower internal energy transport losses.

Perimeter Daylighting

Double-loaded corridors run down the spine of each of the two arms of the building. This provides efficient light access to each side of the narrow floorplate. The layout maximizes natural day lighting while minimizing the heating and cooling loads.



First Floor Work Station with Natural Light

Credit: Bill Haydock, Yukon Energy Corporation

Core Daylighting

The building layout avoids the existence of a building core, thus avoiding the problem of providing light to the core. Sidelighting provides sufficient light the majority of the time (except during the winter months, when daylight availability is scarce in the northern hemisphere.)



Hallway with no Electric Lighting

Credit: Bill Haydock, Yukon Energy Corporation

Glazing and Selection

Triple-pane, spectrally selective low-e glazing with vinyl frames let in a high level of daylight while simultaneously minimizing solar cooling loads and winter thermal loss. Large areas of glass provide visual access to the outdoors and enhance the daylight usage of the building. Opening casements are used throughout the building.

Shading and Visual Comfort

External sunshades on the south help reduce heat gain while ensuring maximum daylight to office areas. The shades have horizontal louvered elements in combined horizontal and vertical sections to allow snow shedding. User controlled blinds provide additional internal shading.



A view of the Extensive Use of Overhangs on the South Side of the Building

Credit: Bill Haydock, Yukon Energy Corporation



A View of Exterior Louvers From the Inside

Credit: Bill Haydock, Yukon Energy Corporation

Auxiliary Lighting

Auxiliary lighting is provided by suspended direct/indirect lighting fixtures with T-8 lamps and electronic ballasts. The lights are controlled by single-step daylighting sensors, occupancy sensors and a programmable light schedule. There are occupancy sensors located in each room, with a manual override option available. The system provides a high-quality lighting environment with a lighting power density of 12.3 W/m². Lighting levels are at, or above IES recommendations, making task lighting unnecessary. Outside lighting is controlled by a photocell.

Mechanical Coordination

The HVAC system capacities were significantly reduced through the architectural and electrical strategies utilized in the building design and construction. The heating plant is a combination of oil and electric boilers. The electric boilers operate only when off-peak electricity is available from the on-site hydro station. Simultaneous heating and cooling is virtually eliminated through the use of a compartmentalized four-pipe fan coil HVAC system. Ground water, instead of conventional mechanical refrigeration equipment, is used for cooling during the summer months.

Commissioning

Commissioning consisted of post-construction calibration of daylighting sensors' and review of efficacy of external shades with respect to glare control.

The building is virtually 100% daylit for extended periods of the day. Daylighting energy savings approach 50% of total lighting energy. Occupant response has been positive.

References

- ANSI/ASHRAE/IESNA Standard 90.1 – 2001, Energy Standard for Buildings Except Low-Rise Residential Buildings, 2001.
- ASHRAE, ASHRAE Handbook: Fundamentals, 1997.
- Enermodal Engineering Ltd, “Energy-Efficient Residential and Commercial Windows Reference Guide”, Canadian Electricity Association, 1st Edition, February 1995.
- Enermodal Engineering Ltd, “Green on the Grand Final Monitoring Report”, Natural Resources Canada, November 1998.
- Environmental Building News, “Daylighting: Energy and Productivity Benefits”, Volume 8, Number 9, September 1999.
- IESNA, The IESNA Lighting Handbook, Ninth Edition, 2000.
- IESNA Lighting Power Density, URL: <http://206.55.31.90/cgi-bin/lpd/lpdhome.pl> (Accessed June 21, 2001).
- Lawrence Berkley National Laboratory, Building Technologies Program, Tips for Daylighting With Windows, January 1997.
- Lechner, N., “Heating, Cooling, Lighting Design Methods for Architects”, John Wiley & Sons, 1991.
- McKay, D.C. and R.J. Morris, “Solar Radiation Data Analyses for Canada 1967-1976” Volume 3: Ontario, Environment Canada, 1985.
- Natural Resources Canada, OEE Conference p. 131, 1996.
- NRC/CNRC, Model National Energy Code of Canada for Buildings (MNECB), 1997.
- Rusak, B., Eskes, G.A. and Shaw, S.R. Lighting and Human Health – A Review of the Literature, prepared for Canada Mortgage and Housing Corporation – Technical Policy & Research Division, 700 Montreal Rd., Ottawa, ON K1A 0P7, 1995.