



BRICK VENEER CONCRETE MASONRY UNIT BACKING

BEST PRACTICE GUIDE
BUILDING TECHNOLOGY



CMHC offers a wide range of housing-related information.
For details, contact your local CMHC office or call **1-800-668-2642**.

Cette publication est aussi disponible en français sous le titre :
Fond en blocs de béton et placage de brique—61311.

CMHC—HOME TO CANADIANS

Canada Mortgage and Housing Corporation (CMHC) is the Government of Canada's national housing agency. We help Canadians gain access to a wide choice of quality, affordable homes.

Our mortgage loan insurance program has helped many Canadians realize their dream of owning a home. We provide financial assistance to help Canadians most in need to gain access to safe, affordable housing. Through our research, we encourage innovation in housing design and technology, community planning, housing choice and finance. We also work in partnership with industry and other Team Canada members to sell Canadian products and expertise in foreign markets, thereby creating jobs for Canadians here at home.

We offer a wide variety of information products to consumers and the housing industry to help them make informed purchasing and business decisions. With Canada's most comprehensive selection of information about housing and homes, we are Canada's largest publisher of housing information.

In everything that we do, we are helping to improve the quality of life for Canadians in communities across this country. We are helping Canadians live in safe, secure homes. CMHC is home to Canadians.

Canadians can easily access our information through retail outlets and CMHC's regional offices.

You can also reach us by phone at 1 800 668-2642
(outside Canada call (613) 748-2003)
By fax at 1 800 245-9274
(outside Canada (613) 748-2016)

To reach us online, visit our home page at www.cmhc-schl.gc.ca

Canadian Cataloguing in Publication Data

Malhotra, Ashok, 1950-

Brick veneer concrete masonry unit backing

(Best practice guide: building technology)

Issued also in French under title: Fond en blocs de béton et placage de brique.

Accompanied by CD-ROM with CAD drawings.

Includes bibliographical references.

ISBN 0-660-17110-4

Cat. no. NH15-132/1-1997E

1. Exterior walls – Design and Construction.
2. Exterior walls – Thermal properties.
- I. Canada Mortgage and Housing Corporation.
- II. Title.
- III. Series.

TH2235.M34 1997 690'.12 C97-980307-1

Re-printed 2001

© 1997 Canada Mortgage and Housing Corporation

Printed in Canada
Produced by CMHC

CMHC STATEMENT

Canada Mortgage and Housing Corporation, the Federal Government's housing agency, is responsible for administering the *National Housing Act*.

This legislation is designed to aid in the improvement of housing and living conditions in Canada. As a result, the corporation has interests in all aspects of housing and urban growth and development.

Under Part IX of this Act, the Government of Canada provides funds to CMHC to conduct research into the social, economic, and technical aspects of housing and related fields, and to undertake the publishing and distribution of the results of this research. CMHC therefore has a statutory responsibility to make widely available information that may be useful in the improvement of housing and living conditions.

This publication is one of the many items of information published by CMHC with the assistance of federal funds.

ACKNOWLEDGEMENTS

This guide was prepared for the High Rise Innovation Centre, Canada Mortgage and Housing Corporation by Ashok Malhotra, P.Eng., Halsall Associates Limited in joint venture with Herb Otto, B.Arch, OAA, MRAIC, Otto, Bryden, Erskine, Martel Architects Inc., Otto & Erskine Architects Inc. The development of this guide has been greatly assisted by the expertise of Masonry Canada. The advice and assistance of CMHC Project Managers Jacques Rousseau and Sandra Marshall, and of Stewart Earle and Gary Sturgeon, who provided much practical information and brought their expertise and critical judgement to bear on the later drafts of the documents, is gratefully acknowledged. We also appreciate the guidance of Mark Patamia.

DISCLAIMER

The analysis, interpretations, and recommendations are those of the consultants and do not necessarily reflect the views of CMHC or those divisions of the corporation that assisted in preparation and publication.

Care has been taken to review the research summarized in this guide, but no attempt has been made to replicate or check experimental results or validate computer programs. Neither the authors nor CMHC warrant or assume any liability for the accuracy or completeness of the text, drawings, or accompanying CD-Rom, or their fitness for any particular purpose or project. It is the responsibility of the user to apply professional knowledge in the use of the information contained in these drawings, specifications, and texts, to consult original sources, or when appropriate, to consult an architect or engineer.

INTRODUCTION

vi

1 / ADVANTAGES OF MASONRY

Design Advantages	1-1
Construction Advantages	1-1
In-Service Advantages	1-1
Thermal Advantages of Masonry Construction: The M Factor	1-2

2 / COMPONENTS OF THE ASSEMBLY

Introduction	2-1
Brick	2-1
Concrete Masonry Units	2-7
Mortar and Grout for Unit Masonry	2-15
Connectors	2-31
Vertical and Horizontal Masonry Reinforcement	2-49
Insulation	2-49
Air Barrier and Vapour Barrier	2-55
Flashings	2-56
Sealants	2-58
Cavity (or Air Space)	2-61

3 / BUILDING SCIENCE CONCEPTS

Introduction	3-1
Heat Flow	3-1
Air Flow	3-4
Water Vapour Flow	3-8
Rain Penetration	3-11
Water and Moisture Control	3-12
Fire Stopping	3-19
Design of Masonry to Accommodate Movement	3-20
Structural Design	3-28

4 / DETAILS

Introduction	4-1
Exterior Wythe	4-1
Insulation	4-1
Air Barrier System	4-3
Wall Cavity	4-4
Vapour Barrier	4-7
Masonry Ties	4-7
Rain Penetration Control	4-8
Detail Notes	4-9

5 / SAMPLE SPECIFICATIONS

Preamble	5-1
Section 04050 – Masonry Procedures	5-2
Section 04100 – Mortar and Grout for Masonry	5-10
Section 04150 – Masonry Accessories	5-12
Section 04160 – Masonry Reinforcing and Connectors	5-14
Section 04210 – Brick Masonry	5-15
Section 04220 – Concrete Unit Masonry	5-18
Section 07190 – Air/Vapour Barrier Membrane	5-21
Section 07210 – Board Insulation	5-25
Section 07620 – Metal Flashings	5-29
Section 07900 – Sealants	5-32

6 / CONSTRUCTION SEQUENCING

Introduction	6-1
Sequencing	6-1
Concrete Block Backing	6-2
Air/Vapour Barrier in Cavity	6-3
Insulation	6-3
Exterior Masonry Wythe	6-4
Flashings	6-4
Shelf Angles and Lintels	6-4
Joints and Junctions	6-5
Bid Document Review	6-5

7 / INSPECTION AND QUALITY CONTROL

Quality	7-1
Responsibilities	7-1
Quality Control and Quality Assurance	7-2
Inspection	7-2
Steps for Quality Assurance	7-3
Brick Facing/Concrete Block Backing with Cavity: Site Inspection Checklist	7-4

8 / COMMISSIONING THE BUILDING ENVELOPE

Introduction	8-1
Implementation Outline	8-1
Benefits of the Commissioning Process	8-2
Implementation Details	8-2

9 / MAINTENANCE AND REPAIR

Maintenance	9-1
General Inspection	9-1
Repair	9-3
Common Defects and Consequences	9-4

REFERENCES

References	R-1
------------	-----

APPENDIX A

Files on Disk	A-1
---------------	-----

LIST OF TABLES

Table 2.1: Physical Requirements	2-2
Table 2.2: Grade Requirements for Brick Exposure	2-6
Table 2.3: Physical Properties of Concrete Masonry Units	2-11
Table 2.4a: Proportion Specifications for Mortar	2-28
Table 2.4b: Proportion Specifications for Grout	2-28
Table 2.5a: Property Specifications for Mortar	2-29
Table 2.5b: Property Specifications for Grout	2-29
Table 2.6: Protection Requirements for Cold Weather Work	2-30
Table 2.7: Wind Chill Factors	2-30
Table 2.8: Construction Requirements for Cold Weather Work	2-31
Table 2.9: Standards for Conventional Connectors	2-33
Table 2.10: Standards for Non-conventional Connectors	2-33
Table 2.11: Maximum Permissible Spacings for Masonry Ties and Masonry Wall Anchors by CSA Standard A370	2-43
Table 2.12: Minimum Level of Corrosion Protection for Masonry Connectors	2-47
Table 2.13: Maximum Spacings for Conventional and Non-conventional Ties	2-48
Table 2.14: Maximum Permissible Spacing at Openings for Ties	2-48
Table 2.15: Maximum Permissible Spacing at Top and Bottom of Walls	2-49
Table 3.1: Wall Assembly Thermal Resistance (RSI)	3-3
Table 3.2: Calculation of Average Thermal Resistance	3-3
Table 3.3: Typical Deformation Properties for Some Common Building Materials	3-22
Table 3.4: Movement Joint Spacing	3-32
Table 9.1: Estimated Service Life of Related Materials and Systems	9-1
Table 9.2: Inspection Checklist for Brick Facing/Concrete Block Backing/Cavity	9-2
Table 9.3: Summary of Masonry Defects and Causes	9-6

LIST OF FIGURES

Chart 2.1: Mortar Compliance, A179-1994	2-4
Figure 2.2: Typical BV/CMU Drainage Wall	2-8
Figure 2.3: Masonry Joints Recommended for Exterior Weatherproof Construction	2-13
Figure 2.4: Conventional Brick/Block Backup Ties	2-14
Figure 2.5: Welded Truss or Ladder Ties/Joint Reinforcing	2-17
Figure 2.6: Adjustable Tie	2-18
Figure 2.7: Special Tie Spacing Requirements	2-21
Figure 2.8: Lateral Stability Anchor	2-22
Figure 2.9: Lateral Support Anchor	2-25
Figure 2.10: Sealant Joints	2-26
Figure 2.11: Mortar-dropping Control Device	2-34
Figure 2.12: Mortar-dropping Control Device (High-density Polyethylene)	2-38
Figure 2.13: Anchorage of Intersecting Walls (Type 1)	2-41
Figure 2.14: Anchorage of Intersecting Walls (Type 2)	2-44
Figure 2.15: Anchorage of Intersecting Walls (Type 3)	2-51
Figure 2.16: Weathering Index Map of Canada	2-54
Figure 2.17: Annual Rain Index	2-57
Figure 2.18: Beveling the Inside Bed Joint	2-60
Figure 3.1: Thermal Resistance	3-6
Figure 3.2: Rain and Air Pressure	3-9
Figure 3.3: Brick Distress Caused by Insufficient Gap Below Shelf Angle	3-10
Figure 3.4: Shelf Angle Details	3-13
Figure 3.5: Location of Movement Joints	3-14
Figure 3.6: Movement Joints	3-17
Figure 3.7: Location of Movement Joints	3-18

LIST OF DETAILS

Detail 4.1a: Foundation/Wall	4-11
Detail 4.1b: Alternative Foundation/Wall	4-13
Detail 4.1c: Alternative Foundation/Wall	4-15
Detail 4.2a: Window Sill (Wood Window)	4-19
Detail 4.2b: Window Sill (Aluminum Window)	4-21
Detail 4.2c: Window Head	4-25
Detail 4.2d: Window Jamb	4-27
Detail 4.2e: Flashing/Sill Types	4-28
Detail 4.2f: Typical Extruded Aluminum Sill	4-29
Detail 4.3a: Slab/Wall	4-31
Detail 4.3b: Alternative Slab/Wall	4-35
Detail 4.4: Patio Door/Balcony	4-39
Detail 4.5: Wall/Column	4-41
Detail 4.6: Parapet/Wall	4-43
Detail 4.7a: Wall Above Flat Roof	4-45
Detail 4.7b: Patio Door/Wall Above Flat Roof	4-47
Detail 4.8a: Cantilevered Floor	4-51
Detail 4.8b: Cantilevered Floor	4-53
Detail 4.9: Exterior and Interior Corners	4-55
Detail 4.10a: Curtain Wall/Sill	4-57
Detail 4.10b: Curtain Wall/Head	4-61
Detail 4.11: Structural Expansion Joint	4-63
Detail 4.12: Brick and CMU Movement Joint	4-65

INTRODUCTION

This guide on brick veneer/concrete masonry unit building technology is one of a series of CMHC technical publications that provides practical information for building designers. The guide is based on CMHC findings from surveys of Canadian building conditions.

One of the major contributors to envelope defects has been a failure to apply existing knowledge of envelope construction in the form of details that builders can use during construction. The Best Practice Guide series is intended to encourage state-of-the-art construction by providing detailed descriptions and CAD details of building features that can be adapted and developed by professionals to suit the particular conditions of their buildings.

Chapters 1 and 2 describe the various components and materials used in brick veneer/concrete masonry unit backing. They also provide references to relevant industry standards.

Chapter 3 outlines the building science concepts that underpin the CAD details in the rest of the guide.

CAD details in Chapter 4 illustrate such features as window sills, parapets, curtain walls and patio doors. Explanatory notes outline how each feature works, and checklists are provided for designers and builders. An accompanying diskette contains AutoCAD files of the details in chapter 4.

Chapter 5 supplements the earlier descriptions with specifications for masonry wall design and construction. Chapters 6 to 8 deal with construction sequencing, inspection, quality control and commissioning the building envelope. Chapter 9 offers guidance on maintenance and repair.

A reference section lists other useful publications on masonry construction, design and research. The appendix is a guide to the use of the diskettes.

This guide is intended to be supplemented by the knowledge of the professional architect and engineer, and by local codes and building practices, with proposed details modified to suit the particular conditions of the proposed building, including location, use and occupancy. Products shown in this guide are for illustrative purposes only and are not intended to promote a specific product over others available on the market.

Masonry is the oldest and most commonly used building material in the world. From the pyramids to the Taj Mahal, masonry has proven to be a material of strength and durability.

DESIGN ADVANTAGES

- technically familiar
- modular construction
- aesthetically superior
- multi-coloured and multi-textured, allowing for unparalleled richness in texture and effects
- easily formed into different shapes
- open to adventures in design
- public acceptability
- fastenable surface
- inherently fire-resistant
- inherently soundproof
- suitable for high-rise and low-rise buildings
- thermally massive and energy conserving
- recyclable material
- simplicity of structural design
- structural elegance of CSA Standard S304.1 Masonry Design (LSD), which allows masonry to compete directly with other structural systems

CONSTRUCTION ADVANTAGES

- easily adjusted to on-site conditions
- tolerances easily accommodated
- large, mobile labour force
- simple, robust construction
- all-weather construction

IN-SERVICE ADVANTAGES

- tough, impact-resistant material
- proven record of durability
- virtually maintenance free
- adaptable; openings can be easily formed
- washable surfaces
- energy conserving because of its thermal storage capability
- residual value
- no contribution to offgassing or indoor air quality problems
- low life-cycle cost

THERMAL ADVANTAGES OF MASONRY CONSTRUCTION: THE M FACTOR

Masonry walls exhibit overall thermal performance superior to that of walls with metal framing systems with insulation of the same RSI value because their mass gives masonry walls the following advantages:

- Effective RSI value of a masonry wall is higher than a metal framed wall because two-dimensional heat flow and thermal bridging occurs at highly conductive metal framing members. (See Appendix B and Appendix C of the *Model National Energy Code for Buildings 1997*.)
- Masonry walls keep buildings warmer in winter and cooler in summer; they act as passive solar collectors, even if they are not designed to do so.
- Masonry walls act as a heat sink, absorbing and storing heat, and releasing it when low temperatures prevail. This reduces energy flow peaks and makes possible the use of smaller, cheaper heating and air-conditioning equipment.

For example, a building with masonry exterior walls will take up to 8 hours to transfer a temperature differential of 20°C (36°F) from outside to inside – eight times as long as a non-masonry building of the same size, design and insulation would take.

This means that on a hot summer day, the outside temperature cannot work its way through the masonry wall before the cooler evening temperature arrives. The process works in reverse in winter. The time lag buys valuable time for the building's heating and cooling systems.

With masonry exterior walls, your building will stay cooler in summer and warmer in winter!

INTRODUCTION

A wall consisting of brick facing, concrete block backing and a cavity can be designed as either a cavity wall or a veneer wall. The difference is in the structural design. Refer to [Figure 2.2](#), (p. 2-8) for a typical assembly.

Cavity wall: a construction of masonry units laid up with a cavity between the wythes. The wythes are tied together with metal connectors and are relied on to act together in resisting lateral loads.

Veneer wall: a non-load-bearing facing attached to, and laterally supported by, the structural backing.

In both types of wall the cavity acts as a drainage medium; water that enters the facing can drain down and be directed out by the flashing. The cavity also facilitates drying of wall components, and serves as a capillary break to resist the movement of moisture through the wall. For pressure-equalized rain-screen walls, the cavity also acts as a pressure chamber.

The following components of the wall assembly are addressed in this chapter:

- brick
- concrete block
- mortar and grout
- connectors
- joint reinforcement
- insulation
- air barrier and vapour barrier
- flashings
- sealants
- cavity (or air space)

BRICK

This section describes the criteria for the selection of brick masonry to be used in the envelope. The designer must select the proper grade brick for weatherability according to local climatic conditions and, in the case of burned clay brick, most suitable in appearance. A further important consideration in the selection of bricks is the initial rate of absorption (IRA).

Three materials are used for the manufacture of brick:

- burned clay or shale
- calcium silicate (sand-lime)
- concrete

PHYSICAL PROPERTIES

Brick Grade

Standards for burned clay brick and calcium silicate building brick use the engineering properties of brick to establish and assign two grades of durability:

- Grade SW: high degree of resistance to frost action and disintegration by weathering
- Grade MW: moderate degree of weather resistance, used only where the unit is not likely to be permeated by water when exposed to freezing temperatures

The grade of burned clay brick is determined by the manufacturer and is established by either of two compliance paths, using test procedures described in CSA A82.2-M78, “Methods of Sampling and Testing Brick”:

Path A	Satisfying cyclic freeze-thaw testing of saturated brick based on evidence of loss of mass, strength, cracking or disintegration	The cyclic freeze-thaw test specified in CSA A82.2-M78 takes approximately 70 days to perform. This makes it impractical to carry out testing on a kiln run of brick <i>before</i> it is laid up on site.
Path B	Satisfying limits on three physical properties: <ul style="list-style-type: none"> • compressive strength • water absorption by 5-hour boil test • saturation coefficient (or <i>C/B</i> ratio) 	<p>The 5-hour boil test provides an indication of the pore space available for water in an extreme environment involving high temperature and some pressure.</p> <p>The <i>C/B</i> ratio compares a brick’s rate of absorption under two different submersion conditions – a 24-hour submersion in cold water, and a 5-hour submersion in boiling water.</p> <p>Satisfying the standards related to only one or two of the three physical properties does not necessarily ensure durability.</p>

CAN/CSA A82.1 sets out the standards for the three Path B physical requirements for each of the two brick grades (Table 2.1).

Table 2.1: Physical Requirements

Designation	Minimum compressive strength (brick flatwise), MPa (psi), gross area		Maximum water absorption by 5 h boiling, %		Maximum saturation coefficient*	
	Average of 5 bricks	Individual	Average of 5 bricks	Individual	Average of 5 bricks	Individual
Grade SW	20.68 (3000)	17.24 (2500)	17.0	20.0	0.78	0.80
Grade MW	17.24 (2500)	15.17 (2200)	22.0	25.0	0.88	0.90

Source: Reproduced from CAN/CSA A82.1

Note: * The saturation coefficient is the ratio of *C:B* where *C* is the rate absorption after 24 h submersion in “cold water” and *B* is the rate of absorption after 5 h in boiling water.

More durable brick units generally have a lower *C/B* ratio.

The grade of calcium silicate brick is established exclusively by satisfying limits on:

- unit compressive strength
- unit modulus of rupture

Concrete brick is classified as:

- Type I – brick suitable for use in facing masonry exposed to the weather
- Type II – brick intended for use as backup or interior facing masonry and not suitable for exposure to the weather

As with burned clay brick, cyclic freeze-thaw testing or measures of compressive strength, water absorption and saturation coefficient are used to classify concrete brick as Type I or Type II.

Brick Type (Burned Clay Brick Only)

The CSA recognizes three types of burned clay brick (CAN/CSA-A82.1-M87), based on their appearance (as defined by chippage, warpage and dimensional tolerance). The three types are:

1. Type FBX, which are for general use in exposed exterior and interior masonry walls and partitions. Type FBX is specified where a high degree of mechanical perfection, narrow colour range and minimum variation in size are required.
2. Type FBS, which, like type FBX, are for general use in exposed exterior and interior masonry walls and partitions, but this brick type can be used where a wider range of brick colour and size is permitted.
3. Type FBA, which are manufactured and selected to produce characteristic architectural effects resulting from non-uniformity in size, colour and texture of the individual units.

When brick type is not specified, it is acceptable to use type FBS.

CSA standards for calcium silicate brick and concrete masonry brick do not classify them into different types based on appearance.

Initial Rate of Absorption (IRA) for Burned Clay Brick

A moderate rate of water absorption or suction is desirable from the point of view of both bond and water tightness. However, in summer, if the IRA exceeds $30 \text{ g/min} \cdot 194 \text{ cm}^2 \text{ net area}$ ($.066 \text{ lb./min.} \cdot 0.3 \text{ in.}^2$), then corrective measures such as wetting the brick must be used. In summer, these *hot* bricks should be wetted, preferably 3 to 24 hours prior to use, to allow moisture to become distributed throughout the unit.

Bricks with extremely low IRAs (5 or lower) should not be used in winter, unless special cold weather requirements of CSA A371-94 are met, because the low rate of absorption increases the likelihood of distress to the masonry if the mortar freezes.

Brick Selection

In summary, designers select bricks according to brick grade (an engineering consideration) related to brick durability (freeze-thaw deterioration), and, for burned clay brick, according to brick type (an architectural consideration) related to finish (chippage) and dimensional stability (warpage and dimensional tolerances).

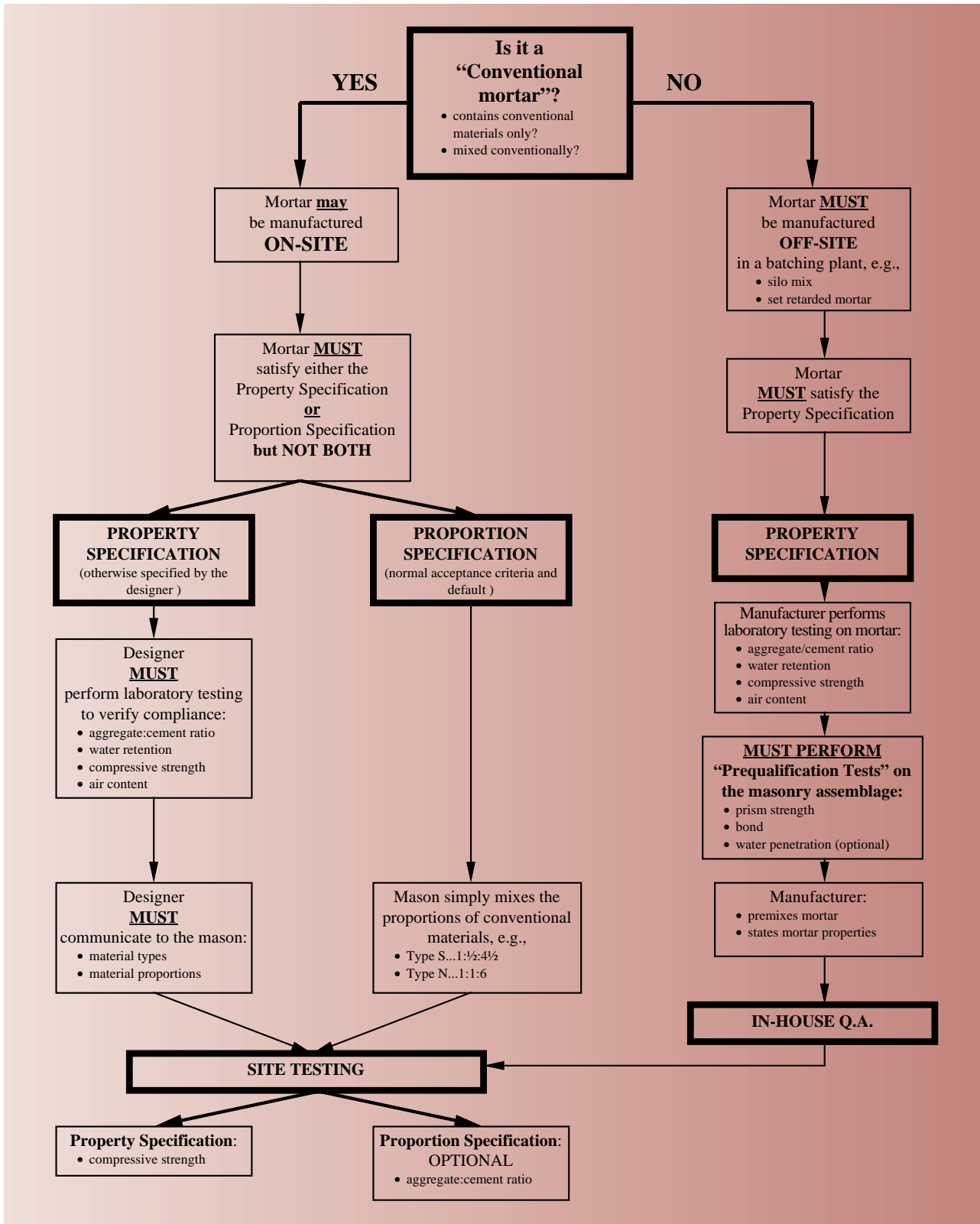

Chart 2.1: Mortar Compliance, A179-1994

Brick durability (freeze-thaw damage) is not an issue **unless** the brick units are saturated or very nearly saturated (above 75% saturation) in service, *and* they concurrently undergo freeze-thaw cycling. The absence of either of these conditions will minimize freezing damage to brick.

Masonry Elements Under Exterior Exposures

Since the designer generally has little control over temperature, temperature changes or freeze-thaw cycling, she or he can reduce the risk of freeze-thaw damage to brickwork in service by selecting design elements that help keep masonry from becoming saturated or nearly saturated during the cold weather months, including late fall and early spring. Such design features might include horizontal surfaces above the masonry to protect against moisture (eaves, cornices); the control of run-off from non-absorbent surfaces above masonry (glazing systems, cap flashings); and the control of ground moisture adjacent to vertical masonry surfaces (snow and ice accumulations, landscape sprinkler systems).

It is good practice to choose a brick with a proven record of performance under anticipated environmental conditions, since interpretation of the results of brick durability tests is semi-empirical. In many instances these durability requirements have proven to be inaccurate indicators of in-situ performance. For instance, units that pass the physical requirements may not pass the freeze-thaw test; units that pass the freeze-thaw test may fail outdoor exposure, and so on. Moreover, the tests are not applicable to all brick and conditions. Pore size and distribution, and not simply total porosity, is important in determining brick durability.

A limit of 50 freeze-thaw cycles by the current standard test is not representative of in-situ performance, where units are frozen unidirectionally rather than omnidirectionally (uniformly saturated, frozen and thawed from all sides) and where units may undergo hundreds of cycles.

Before confirming brick selection, the designer should seek references from the manufacturer and examine five-year-old buildings made of the same brick and situated in environments similar to that anticipated for the building under consideration.

[Table 2.1](#), (p. 2-2) of the CAN/CSA A82.1 Standard [Table 2.2](#), (p. 2-6) provides guidance in grade selection, based on expected exposure (vertical orientation/contact with earth) to weather. This selection guide is incomplete since it considers only the macro-environment. Further consideration must be given to the micro-environment (e.g., exposure dependent on location of the structure, orientation to prevailing winds, position in the element, wall design). In general, only the most durable brick grade should be used in walls exposed to the exterior in Canada.

Table 2.2: Grade Requirements for Brick Exposure

Weathering index (Refer to Figure 2.16 Weathering Index Map of Canada)			
Exposure	Negligible Less than 1 500 cycle-mm (50 cycle-inches)	Moderate 1 500 to 15 000 cycle-mm (50-500 cycle-inches)	Severe Greater than 15 000 cycle-mm (500 cycle-inches)
In vertical surfaces: In contact with earth Not in contact with earth	MW MW	SW SW	SW SW
In other than vertical surfaces: In contact with earth Not in contact with earth	SW MW	SW SW	SW SW

Source: Reproduced from CAN/CSA A82.1

Reclaimed brick that has been used in exterior exposure is not recommended for reuse in an exterior exposure for the following reasons:

- Older brick is generally more porous, of lower strength, and less durable than today’s brick.
- A sizable portion of its total service life has likely been expended, and it is difficult to determine how much remains.
- The bond between the mortar and unit may be incomplete on resetting because of the presence of residual mortar and demolition dust on the surface of the reclaimed bricks. (Incomplete bond, or lack of bond, is the principal cause of moisture penetration through brick masonry.)
- The reclaimed bricks may have absorbed free salts during their previous service life and therefore be efflorescent.

If the use of reclaimed brick cannot be avoided for some reason, it is strongly recommended that every effort be made to keep these units dry under service conditions.

REFERENCE PUBLICATIONS

For more information, consult the following standards:

CSA Standards

- CAN/CSA - A82.1-M 87 (R92)
Burned Clay Brick (Solid Masonry Units Made from Clay or Shale)
- A82.3-M 1978 (R92)
Calcium Silicate (Sand-Lime) Building Brick
- A165.2-94
Concrete Brick Masonry Units
- CAN 3 - A82.8-M78 (R84)
Hollow Clay Brick
- CAN 3 - A82.2-M78 (R92)
Methods of Sampling and Testing Brick
- CAN/CSA-A369.1-M90
Method of Test for Compressive Strength of Masonry Prisms

A370-94
Connectors for Masonry

A371-94
Masonry Construction for Buildings

CAN3-S304-M84
Masonry Design for Buildings

S304.1-94
Masonry Design for Buildings (Limit States Design)

CONCRETE MASONRY UNITS

The selection of concrete masonry units (CMUs) is based on four physical properties or facets. They are block type, compressive strength, density and moisture content. This section explains the four properties and describes the criteria used to select a suitable unit.

PHYSICAL PROPERTIES

Classification

In accordance with CSA Standard A165.1, masonry units are classified by the following physical properties:

1. hollow or solid
2. compressive strength
3. density and water absorption
4. moisture content at the time of shipment

These physical properties are described by code (e.g., H/15/A/0) and are known as the Four-Facet System. [Table 2.3](#), (p. 2-11) summarizes the various physical properties.

First Facet: Solid Content

Concrete blocks are classified as hollow or solid units. A hollow unit is defined as one in which the net cross-sectional area is less than 75% of the gross cross-sectional area. A solid unit is one in which the net cross-sectional area is at least 75% of the gross cross-sectional area. The net cross-sectional area of most units is about 50% to 70%.

Hollow units are more frequently used than solid units because they are lighter, easier to set, and can be grouted and reinforced, while still satisfying structural requirements. Solid units are used in particular circumstances, such as when higher fire ratings are required, or for specific locations, such as tops of walls.

A hollow unit is designated by the letter H, and a solid unit is designated by the letter S.

The 1994 edition of the A165.1 Standard has included the S_f designation for units that are solid without voids, to distinguish this type of unit from the solid unit having voids so defined by the standard.

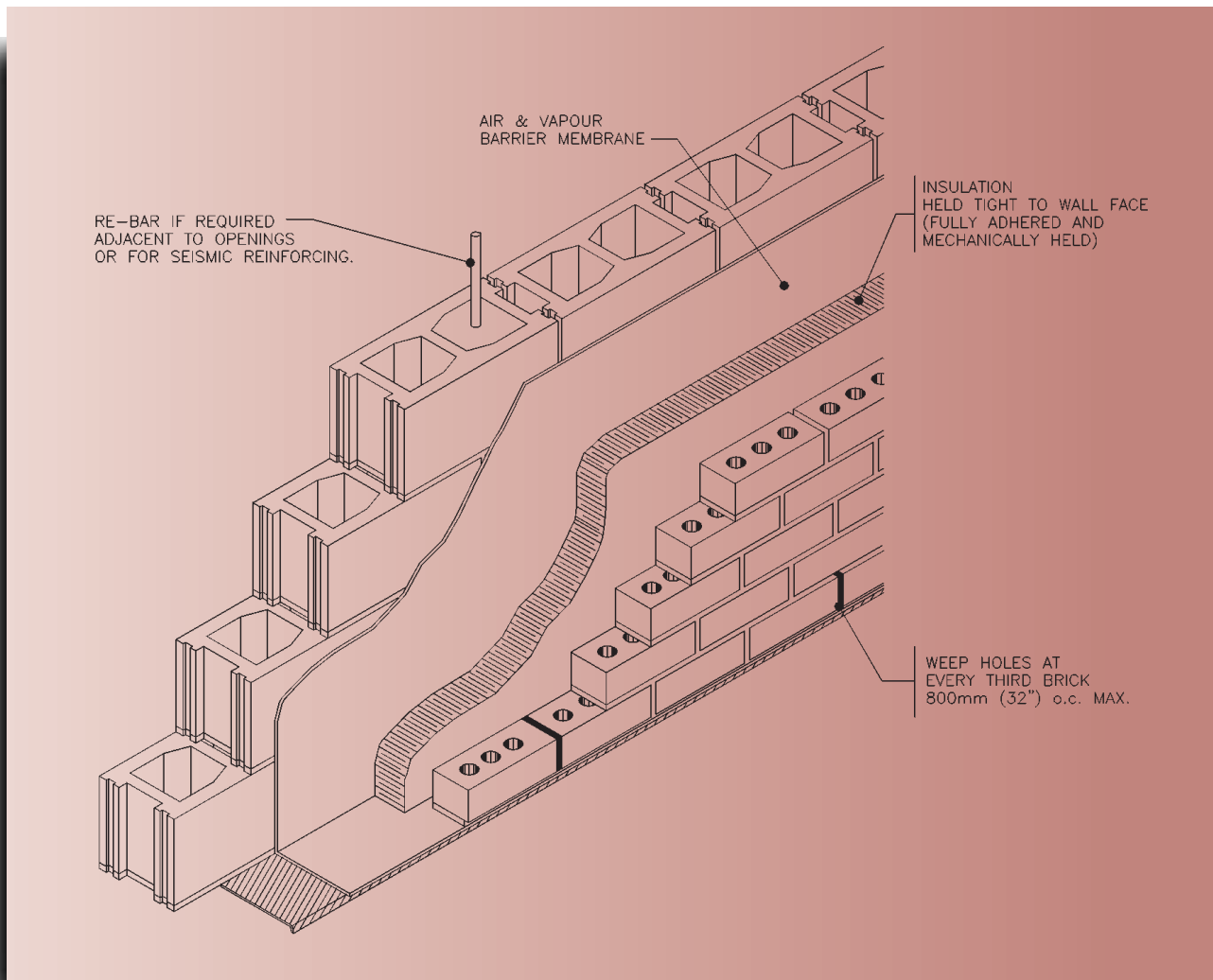

Figure 2.2: Typical BV/CMU Drainage Wall

Second Facet: Compressive Strength

The compressive strength of concrete block units is determined in accordance with ASTM Standard C140, Sampling and Testing Concrete Masonry Units, and is based on the average of three units. As Table 2.3, (p. 2-11) shows, compressive strength is based on *net area* of the concrete block, and several minimum compressive strength classifications are given. Although the standard requires strength to be based on net area and has done so for some time, it is not uncommon to have strengths quoted based on *gross area*; therefore, the designer should note which of the two measures the reported compressive strength is based on.

Compressive strengths based on net area in the order of 15 MPa (2170 psi) to 20 MPa (2900 psi) are standard in the industry. Units having compressive strengths greater than 15 MPa (2170 psi) are considered suitable for exterior construction.

The higher the compressive strength, the better the durability under severe weathering conditions.

Third Facet: Density and Water Absorption

The 1994 edition of A370 specifies five densities of concrete block units; the classification of density is a direct result of the type of aggregate used in the manufacture of the unit.

Normal weight units, those with densities exceeding 2000 kg/m³ (125 lb./ft.³), are typically manufactured from sand and gravel aggregate and are most common in eastern Canada. Semi-lightweight or medium weight units have densities ranging from 1700 to 2000 kg/m³ (106 to 125 lb./ft.³). Lightweight units, most prevalent in western Canada, have densities lower than 1700 kg/m³ (106 lb./ft.³) and, in western Canada, are manufactured from expanded shale.

Lighter and heavier unit types each have advantages and disadvantages:

Lightweight units

- better fire resistance per unit thickness
- improved productivity
- reduced coefficient of thermal expansion
- reduced structural weight
- higher R-value per unit thickness

Normal weight units

- reduced shrinkage
- improved appearance

The third facet also relates block density to maximum permissible water absorption of the unit. These limits are related to a measure of compaction during manufacture, and this property, along with compressive strength, provides a measure of unit durability.

Fourth Facet: Drying Shrinkage and Moisture Control

This facet is, perhaps, the least understood facet and therefore deserves some comment.

Under this facet, the designer may choose either:

- designation “M”, moisture-controlled units, or
- designation “O”, non-moisture-controlled units.

Moisture-controlled Units

Like all cementitious materials, concrete block units expand if they take on moisture and shrink if they lose moisture. When they have a moisture content that is in equilibrium with the moisture content of the surrounding environment, they will neither expand nor contract; they will remain dimensionally stable. By pre-drying the block units to a moisture content that is about in equilibrium with the expected relative humidity of the service environment, the manufacturer of the block effectively preshrinks the units, reduces the amount of in-wall residual shrinkage of the units, and thereby provides some measure of crack control in the constructed masonry.

Moisture-controlled units are pre-dried by the manufacturer and must satisfy the maximum moisture content requirements specified for M units. For the manufacturer to use Table 2.3, (p. 2-11) to determine the acceptable moisture content for M block units on delivery to the job site, two factors must be known:

1. The total linear shrinkage of a concrete block, measured from a saturated condition to a very dry condition (determined in accordance with ASTM C426 “Test Method for Drying Shrinkage of Concrete Block”). This value is determined by the manufacturer of the block on an ongoing basis as part of the quality control program. The total drying shrinkage of the product will fall within one of three shrinkage classifications:
 - less than 0.03%
 - 0.03 to 0.045%
 - more than 0.045%(In general, lightweight concrete block units exhibit higher total shrinkage than normal weight units.)
2. Approximate average relative humidity (RH) for the year at the point of manufacture of the units:
 - RH that is more than 75%
 - RH that is less than 75%

Local manufacture and local delivery of block units is commonplace in Canada, and the standard assumes that the average relative humidity for the service environment will be approximately the same as that at the point of manufacture of the units.

In general, the drier the service environment for the block and the greater the total linear shrinkage of the block, the drier the unit must be on delivery to the job site.

As for the other facets in [Table 2.3](#), (p. 2-11), the designer need not specify the permissible maximum moisture content for the block, but rather, must simply indicate preference for M units in the block specification.

Moisture-controlled units are specified where control on residual shrinkage is desirable. For example, M units are ideally suited for exterior, single wythe masonry wall construction where crack control is needed to help resist air leakage, heat loss and the ingress of precipitation into interior space.

The use of moisture-controlled units does not eliminate the need for movement joints in the masonry element, but does serve to reduce the frequency of movement joints, and the frequency and width of micro-cracks when compared with similar elements constructed with non-moisture controlled units.

After moisture-controlled units are delivered, it is important to protect on-site stockpiles from rain.

CMUs must never be wetted prior to use because wetting destroys the benefits of pre-drying.

Non-moisture-controlled Units

Non-moisture-controlled units, Type O, need not satisfy any limits for maximum moisture content on delivery to the job site.

Non-moisture-controlled units may be specified where the designer is unconcerned about the frequency and width of micro-cracking. They are suitable for use in interior partition walls and inner structural CMU backing for masonry cavity walls containing insulation in the air space with other components forming a suitable air barrier.

There are additional considerations when selecting CMUs.

Table 2.3: Physical Properties of Concrete Masonry Units

Facet	Symbol	Property		
		Solid Content		
First	H*	Hollow		
	S*	Solid (as defined)		
	S _f	Solid without voids		
		Minimum compressive strength calculated on net area† in MPA (psi)		
		Average of 3 units	Individual unit	
Second	2.5	2.5 (362)	The compressive strength of any individual unit shall be not less than 85% of that of the specified average 3 units.	
	10	10 (1450)		
	15	15 (2170)		
	20	20 (2900)		
	30	30 (4350)		
	Concrete Type	Density kg/m³ (lb/ft³)	Absorption, kg/m³ (lb/ft³)	
Third	A	More than 2000 (125)	175 (11)	
	B	1800-2000 (112-125)	200 (12.5)	
	C	1700-1800 (106-112)	225 (14)	
	D	Less than 1700 (106)	300 (18.75)	
	N	No limits	No limits	
		Maximum moisture content, % of total absorption — average of 5 units		
			Moisture content	
Fourth		Linear shrinkage (%)	RH over 75% ‡	RH under 75% ‡
	M	Less than 0.03	45	40
		0.03-0.045	40	35
		More than 0.045	35	30
	O	No limits Not tested (where shrinkage is not of importance)	No limits	
Notes:	See Clauses 2.1.2 and 6.1 CSA A165.1-94 * See Clause 2 of CSA A165.1-94. † See Clause B5 of CSA A165.1-94, Appendix B, which discusses gross and net area. ‡ Average annual climatic relative humidity (per cent) at point of manufacture. 1. It is not intended that manufacturers make masonry units to fit all possible combinations of second, third and fourth facets, but rather that purchasers be able to select from the manufacturer’s range of masonry units a unit that will meet their requirements. For additional information, refer to Appendix D. Most units produced in Canada have a minimum average compressive strength of 15 MPa based on net area. 2. When masonry units are used in a dry environment, such as interior partitions, the maximum water absorption limits need not apply. 3. When masonry units are used under conditions of humidity considerably lower than climatic humidity, additional precautions against shrinkage may be required. 4. When a particular surface texture, finish, colour, uniformity of colour or other special feature is desired, these features should be specified separately by the purchaser. 5. This standard does not provide requirements for fire resistance, thermal transmission, or acoustical properties. The purchaser should specify definite values for any such properties when required (see Appendix B).			

Fire Resistance

Fire resistance rating (in hours) depends on the type of aggregate and the *equivalent concrete thickness* measurement. Expressed in hours, the measure of fire resistance can be obtained from the manufacturer of the units or from block manufacturers' associations of different provinces.

Acoustical Properties

The two main acoustical properties of walls used in buildings are the ability to resist sound transmission and the ability to absorb a percentage of sound. For more information, refer to the *National Building Code of Canada* and masonry industry literature available from manufacturers.

Thermal Properties

Two properties of concrete block affect the thermal design of buildings built using concrete block: resistance to passage of heat and thermal mass of the wall. For more information, refer to Masonry Canada's *Guide to Energy Efficiency in Masonry and Concrete Buildings*, and National Masonry Association Bulletins TEK 58 and TEK 67A.

Durability

The durability of a CMU under normal atmospheric conditions is a function of freeze-thaw resistance rather than its water absorption property or density.

As with brick units, two factors must act concurrently to cause freeze-thaw deterioration of concrete masonry units: the units must be saturated or very nearly saturated; and the units must be exposed to freeze-thaw cycling.

CMUs that have an average compressive strength greater than 15 MPa (2170 psi) (net area) are considered suitable for exterior use, including for foundations and basements.

CMU SELECTION

CMUs are selected and specified based on the following criteria:

- strength and stability (first and second facet)
- fire performance rating (first, second and third facet)
- acoustic requirements (first, second and third facet)
- shrinkage range of units available (fourth facet)
- average in-service relative humidity for the year (fourth facet)

REFERENCE PUBLICATIONS

For more information, consult the following standards and publications:

Canadian Standards Association (CSA) Standards

A165.1-94

Concrete Masonry Units

A371-94

Masonry Construction for Buildings

CAN/CSA-A369.1-M90

Method of Test for Compressive Strength of Masonry Prisms

A370-94

Connectors for Masonry

A165.2-94

Concrete Brick Masonry Units

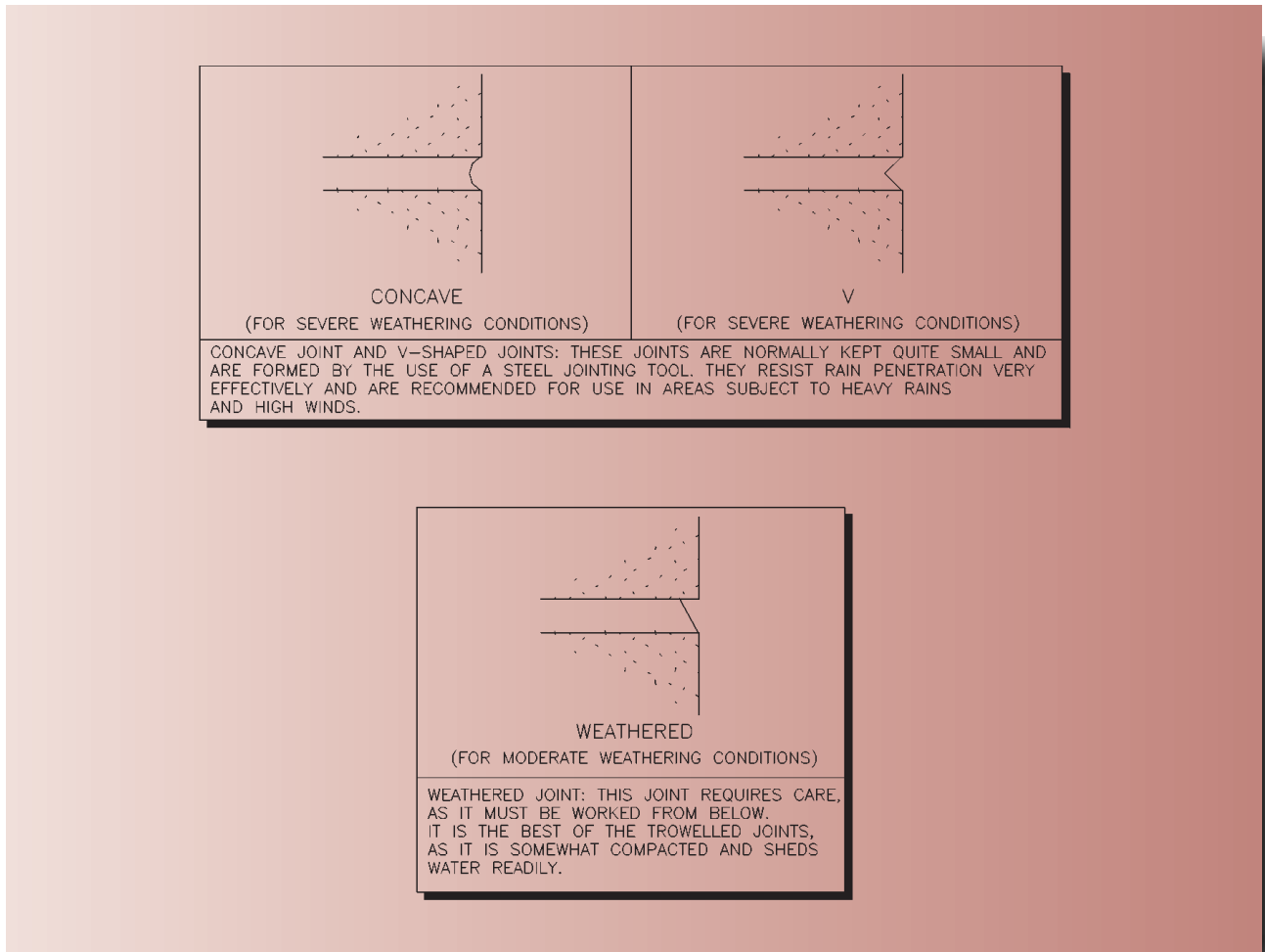

Figure 2.3: Masonry Joints Recommended for Exterior Weatherproof Construction

CAN3-S304-M84

Masonry Design for Buildings

S304.1-94

Masonry Design for Buildings (Limit States Design)

American Society for Testing and Materials (ASTM) Standards

C140-91

Method of Sampling and Testing Concrete Masonry Units

C426-70 (Reapproved 1988)

Test Method for Drying Shrinkage of Concrete Block

National Concrete Masonry Association (NCMA) Bulletins

TEK 39-1972

Noise Control with Concrete Masonry

TEK 53-1973

Design of Concrete Masonry for Crack Control

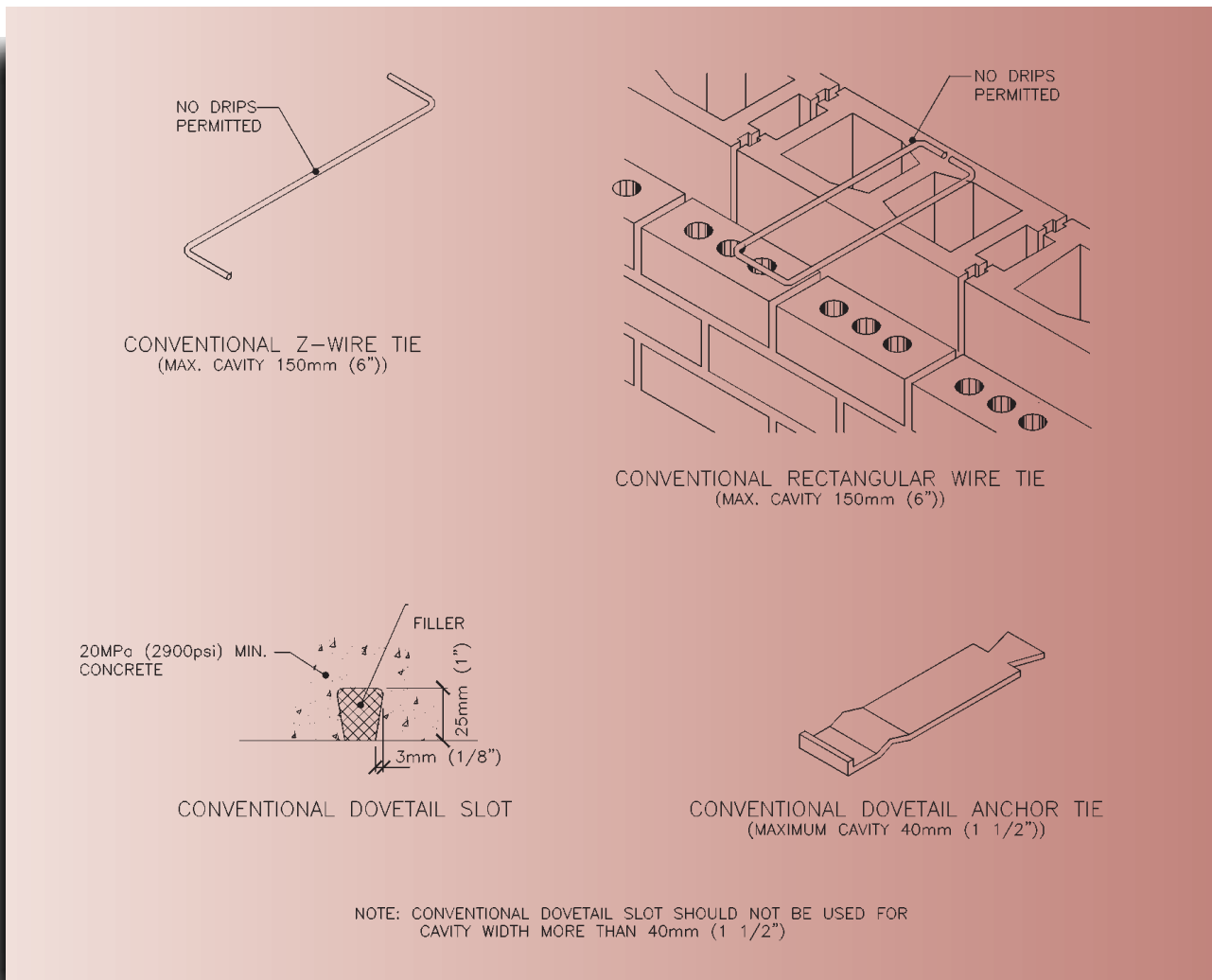

Figure 2.4: Conventional Brick/Block Backup Ties

- TEK 58-1974
Energy Conservation with Concrete Masonry
- TEK 67A-1986
Tables of R Values for Concrete Masonry Walls
- TEK 69B-1990
Sound Transmission Class Ratings for Concrete Masonry Walls
- Masonry Canada (formerly Masonry Council of Canada)**
Guide to Energy Efficiency in Masonry and Concrete Buildings

MORTAR AND GROUT FOR UNIT MASONRY

Mortar is a mixture of cementitious material or materials, lime, sand and water in varying proportions used for bonding, jointing and bedding of masonry units. Grout is a more fluid form of mortar used to fill voids in the masonry. It has higher slump (200 to 250 mm) (8 to 10 in.) because of a higher water-to-cement ratio. Mortar must not be substituted for grout unless permitted by the designer. The selection of mortar and grout mixes is intimately related to the characteristics of the selected masonry units. Important physical properties include strength, water content, workability, flow and water retentivity. These are explained in this section. A compliance chart Chart 2.1, (p. 2-4) outlines CSA A179-94 requirements.

PHYSICAL PROPERTIES

The principal function of masonry mortar is to develop a complete, strong and durable bond with masonry units. Mortar must also create a water-resistant seal.

Ingredients

The principal mortar constituents are:

- cement
- lime
- sand
- water

Each material makes a definite contribution to mortar performance. **Portland cement**, a hydraulic cement, contributes to durability, high early strength and high compressive strength. **Lime**, which sets only on contact with air, contributes to workability, water retention and elasticity. The lime used is hydrated lime conforming to ASTM C207. Hydrated lime is quick lime, which has been slaked before packaging, converting the calcium oxide into calcium hydroxide. Both cement and lime contribute to bond strength. **Sand**, for example, silica sand in white mortar, acts as a filler, providing the most economical mix, and contributing to strength, texture and aesthetics. Too much sand results in a lean mix, difficult to spread. Too little sand results in a fatty mix that causes the mortar to stick to the trowel. **Water** creates plastic workability and initiates the cementing action. **Admixtures**, such as plasticizers and air entraining agents, are added to enhance workability and freeze-thaw resistance.

Proprietary mortar mixes known as masonry cements are widely used because of their convenience and generally good workability and quality. Masonry cements are premixed formulations of portland cement, plasticizers and air entraining agents. Sand and water is added to produce a mortar mix.

Bond Strength

Bond is generally recognized as the most important factor contributing to sound masonry. The term bond refers to a specific property of masonry that has three components:

- extent of bond or degree of contact between mortar and masonry
- bond strength or the force required to separate the units
- durability of bond

Bond between masonry units is required to resist tensile forces and resist the ingress of moisture.

Bond strength depends on:

- mortar type
- the properties of the masonry unit
- curing conditions
- workmanship
- test method

The property of bond is the most variable and unpredictable of all masonry/mortar assembly properties. However, good bond is nearly always assured when:

- mortar has been prepared in accordance with CSA Standard A179 and is applied to unit masonry construction (masonry of clay or shale, sand-lime, or concrete units); and
- the unit masonry is constructed in accordance with CSA Standard A371.

Water Content

Perhaps because of the different water requirements for concrete and mortar, water content is the most misunderstood aspect of masonry mortar. Concretes are placed in non-absorbent formwork, permitting relatively low water-to-cement ratios, which provide workability and maintain high compressive strengths. In masonry construction, however, high water-to-cement ratios are needed for mortars to provide initial workability and to satisfy the rapid absorption of moisture from the mortar by the masonry units. This absorption reduces the in-situ water-to-cement ratio, increases the compressive strength of the mortar, and assures a strong, durable bond. Mortars should be mixed with the maximum amount of water consistent with workability, to provide the maximum tensile bond within the capacity of mortar. A low water-to-cement ratio consistent with workability may provide a mortar of maximum strength, but it may also result in lower than maximum tensile bond strength.

Workability

There is no standard laboratory test for measuring workability. A mortar is workable if its consistency allows it to be spread with little effort and if it will readily adhere to vertical masonry surfaces. Experienced masons are good judges of workability.

Good workability is needed to assure good bond (extent, strength, durability).

Flow and Water Retentivity

The CSA A179-94 property specification for mortars requires a flow of 70% after suction of water under standardized test. Initial flow of 100% to 115% is required.

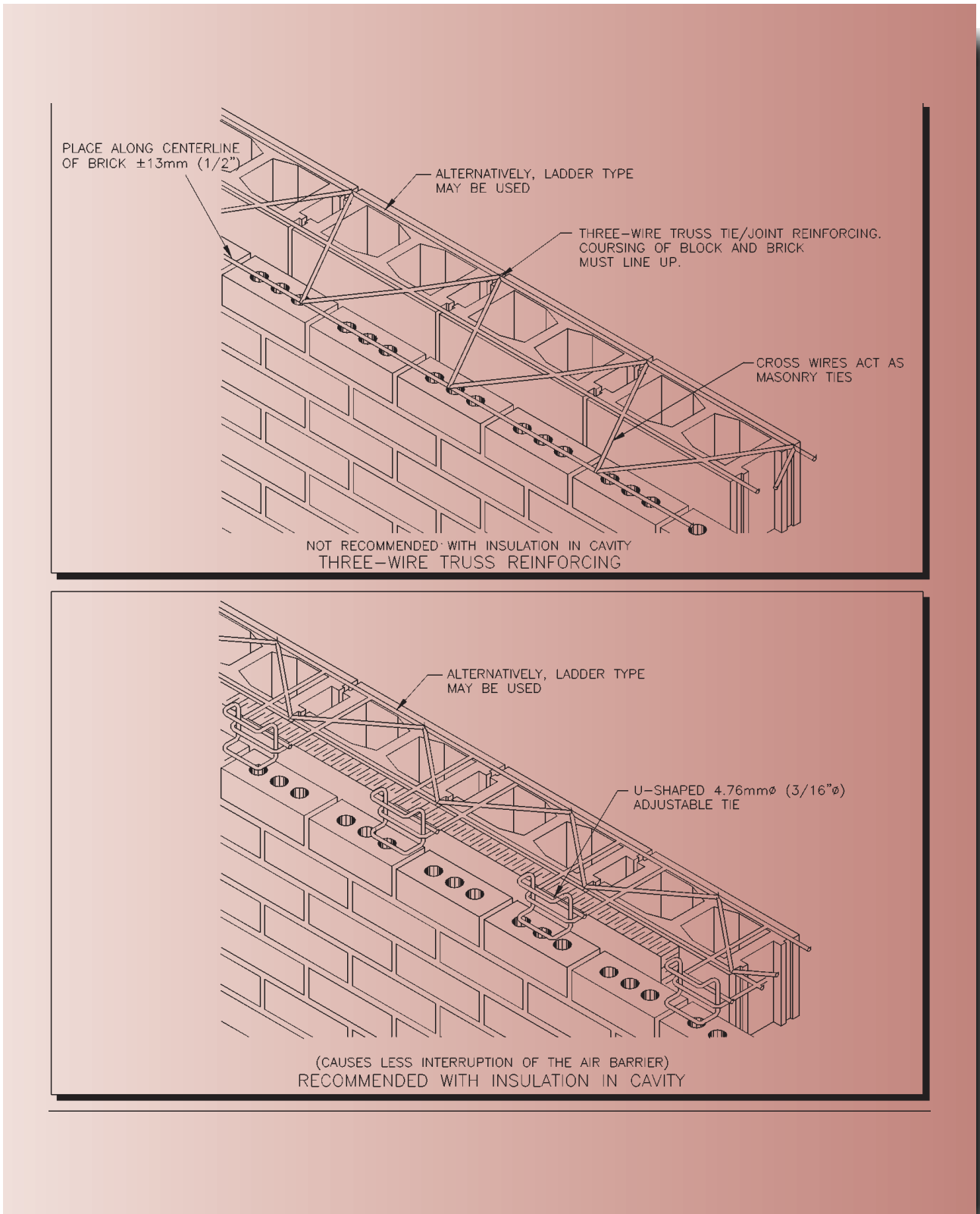
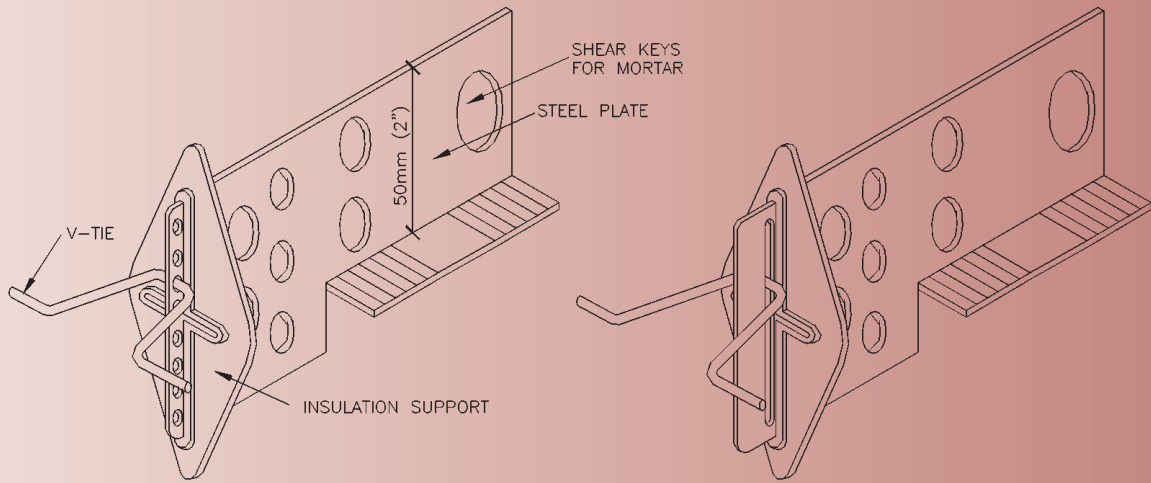

Figure 2.5: Welded Truss or Ladder Ties/Join Reinforcing



SHEAR CONNECTOR

THIS TIE IS USED IF COMPOSITE ACTION IS REQUIRED BETWEEN THE BRICK AND THE BLOCK TO RESIST LATERAL LOADS. (SEE TEXT)

ADJUSTABLE TIE

THIS TIE IS USED IF COMPOSITE ACTION IS NOT REQUIRED.

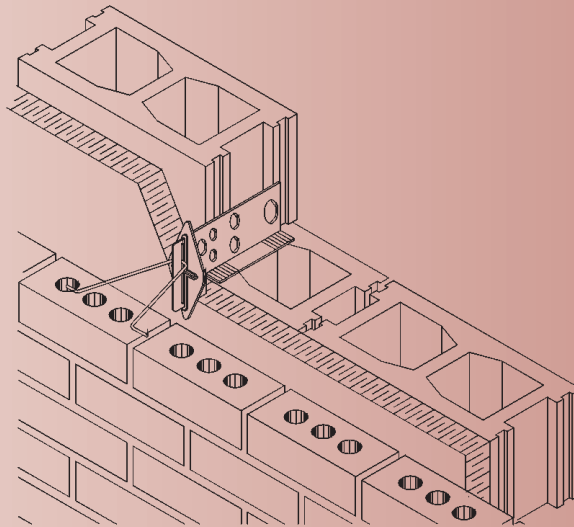

ADJUSTABLE TIE INSTALLATION

Figure 2.6: Adjustable Tie

Mortar Types

Five mortar types are acknowledged for unit masonry construction: K, O, N, S and M. In this order, these designations represent a continuum, in which Type K contains the least cement and the most lime, and Type M contains the most cement and least lime. Along this continuum, compressive strength increases and workability decreases (hence, bond strength generally decreases).

CSA A179-94 recognizes only two mortar types, Type S and Type N, consistent with the new S304.1 Limit States Design Standard. Requirements for these mortar types are contained in the main body of the Standard. Requirements for alternative mortar Types M, O and K, recognized by S304 Working Stress Design Standard, have been moved to the non-mandatory appendix of A179, since they are generally not suitable for today's masonry structures. They may, however, still be used in the following special conditions.

Type M: High Strength, Poorer Bond

Because Type M mortar contains a relatively high proportion of cement and a low proportion of lime, this mortar type shows high compressive strength and durability, but relatively low workability and poorer extent of bond, with the attendant risk of sacrificing some bond. Type M is often used for masonry below grade in contact with earth.

Type O and K: Strong Bond, Lower Strength

Because Types O and K contain a relatively high proportion of lime and a low proportion of cement, this mortar type shows low compressive strength and durability, but relatively good workability and good extent of bond. Type O and K mortars are commonly used today for the restoration of historical masonry buildings.

Proportion Specifications and Property Specifications

The two methods of specifying mortar and grouts are:

- proportion specification
- property specification

Proportion specification of A179 is a simple prescriptive specification, a recipe, and should be used only for mortars and grouts that:

- contain only conventional materials (preapproved materials listed within the standard: portland cements, limes, masonry cements, aggregates)
- are mixed conventionally (for mortar, in a paddle mixer for 3 to 5 minutes; for grout, 5 to 10 minutes)

Property specification of A179 is a more complex compliance path. It is a performance-type compliance path stating the desired result for the mortar and grout, with some guidance about how to achieve it. The Property Specification should be used only for mortars and grouts that:

- are manufactured off-site, in a batching plant (set-retarded, or packaged, dry, combined materials)
- contain non-conventional materials
- are mixed non-conventionally (e.g., by screw auger)

Refer to Chart 2.1, (p. 2-4) for a Mortar Compliance Chart based on A179-1994.

Conventional Materials Considerations

Portland cements, by CSA A5:

- Type 10 – normal
- Type 20 and 50 – provide resistance to sulphate attack from soils and water
- Type 30 – reduce the risk of frost damage to the mortar during cold weather construction

Hydrated limes, by ASTM C207:

- Type S, SA – method of manufacture assures soundness, with no risk of disintegration of the masonry in service
- Type N, NA – No assurance that all oxides are hydrated. Hydration may occur in service, with expansion and risk of disintegration of masonry. However, Canadian Type N limes do not have a soundness problem. They have a proven in-situ and laboratory performance.

Aggregates – limits for the following are prescribed:

- gradation – CSA Test Method A23.2-2A
- friable particles – CSA Test Method A23.2A
- low-density particles – CSA Test Method A23.2-4A
- organic impurities – CSA Test Method A23.2-7A

Water-Soluble Chloride Ion Content in Mortar and Grout

Corrosion of embedded steel in cementitious materials can proceed at a much greater rate in the presence of chloride ions. Consequently, CSA A179 has adopted the water-soluble chloride ion limits used by the concrete industry, and prohibits adding antifreeze liquids, calcium chloride, frost inhibitors based on calcium chloride, salts or other such substances.

MORTAR AND GROUT SELECTION AND MIX DESIGN**Mortar**

For new construction, select mortar type, either:

- Type S for general use below or above grade masonry, where high lateral strength is required
- Type N for general use above grade masonry, where high compressive and/or lateral masonry strengths are not required

There are two basic rules for mortar selection.

1. No single mortar type is considered appropriate for all applications; each mortar type has its strengths and weaknesses (compressive strength vs. workability and bond).
2. Never use a mortar that has more compressive strength than is demanded by the structural requirements of the project.

Mortar Mix Design***Proportion Specification:***

As noted, the proportion specification is a simple prescriptive specification, wherein the constituent materials and the volumes of these materials are prescribed by the standard. Refer to [Table 2.4a](#), (p. 2-28) for mix design.

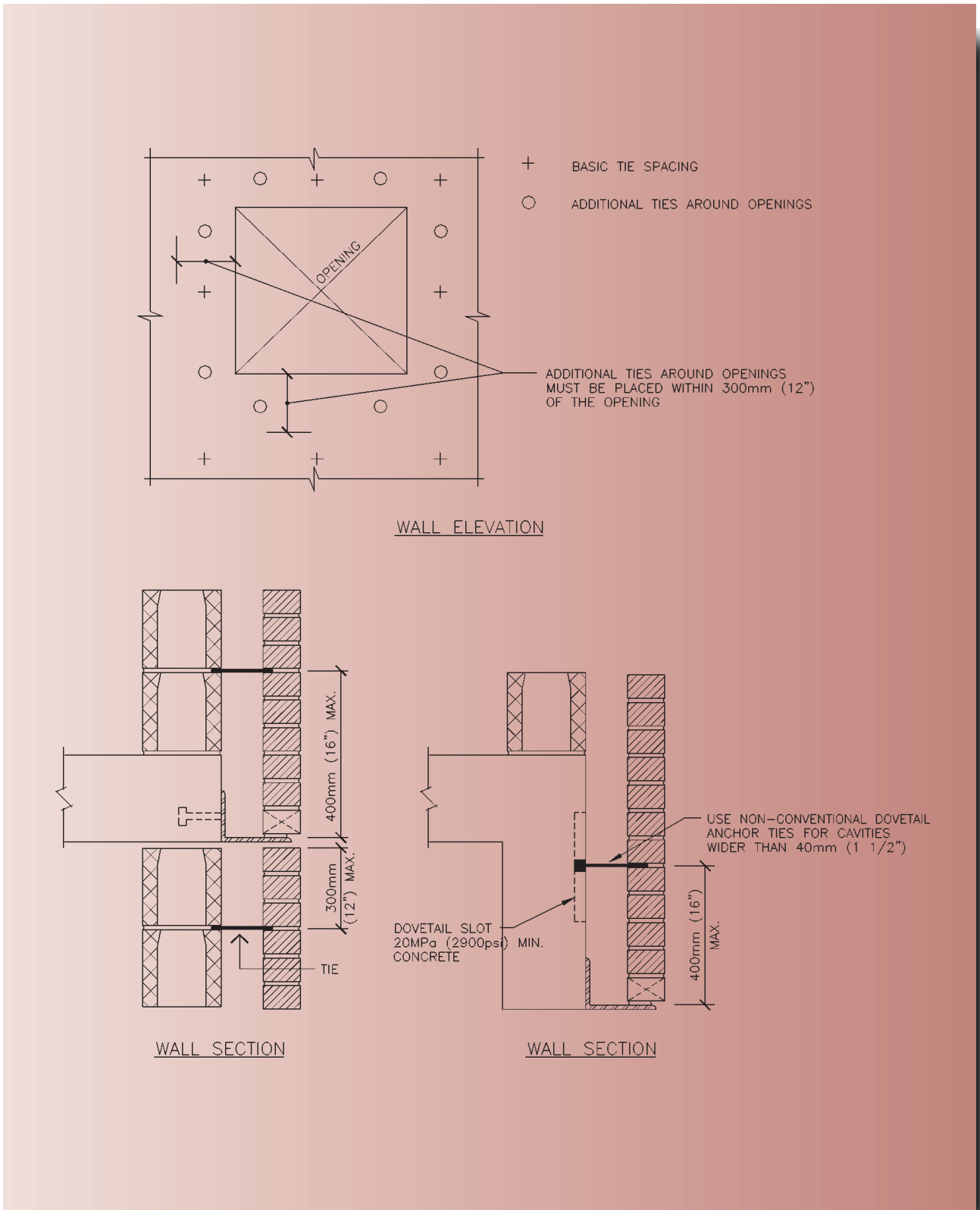

Figure 2.7: Special Tie Spacing Requirements

STEEL PLATE ANCHORED TO UNDERSIDE OF SLAB THROUGH SLOTTED OPENINGS OR WELDED TO CAST IN PLACE INSERTS. INSERT INTO HEAD JOINT OR COLLAR JOINT BETWEEN SOLID UNITS OR GROOVE IN SASH BLOCK.

PLASTIC SLEEVE BOND BREAKER ALLOWS FOR DEFLECTION

9.5mm (3/8") ϕ DOWEL

COMPRESSIBLE FILLER PREVENTS MORTAR PENETRATION (UNDER ROD ONLY)

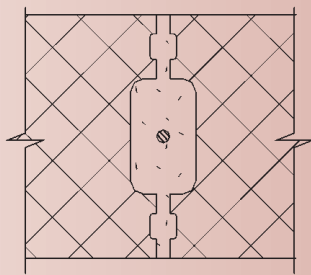
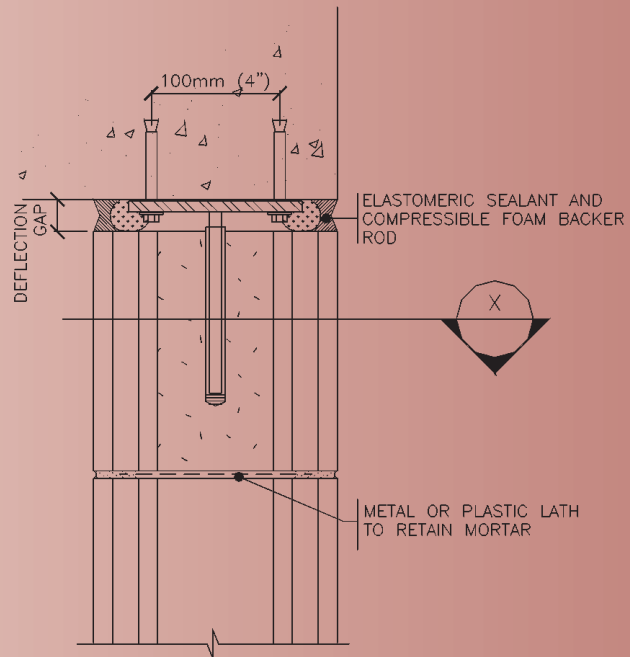
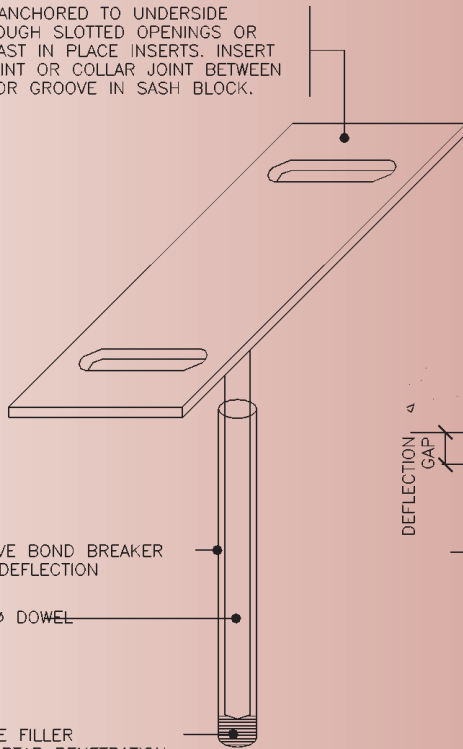

SECTION X
GROOVE IN SASH BLOCK

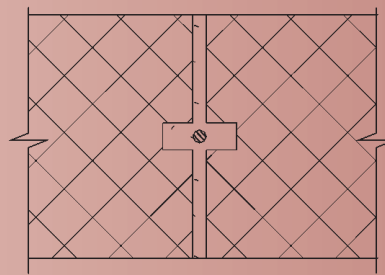

SECTION X
AT FROG

Figure 2.8: Lateral Stability Anchor

Property Specification:

- Maintain a cementitious materials-to-aggregate ratio (by volume) of about 1:2.25–3.5, to ensure a dense mix. Mortars containing smaller sand proportions are generally strong, lack adequate workability, and exhibit excessive drying shrinkage. Mortars containing greater sand proportions are generally weak and porous, and lack durability.
- Consider required freeze-thaw durability: increased lime content reduces mortar freeze-thaw durability.
- Limit air content to 10–12%. This is sufficient to improve freeze-thaw resistance and workability, but is sufficiently low to ensure acceptable bond strength values. Mortars having 10–15% air entrainment have significantly greater resistance to freeze-thaw than those containing 4–7% entrapped air. Air content above 15% does not improve mortar durability; it increases permeability and decreases bond strength.
- Maintain minimum compressive strengths assigned by A179 property specifications for mortar type (See [Table 2.5](#), p. 2-29). Reasonable values for mortar compressive strength provide reasonable assurances that durability, water absorption, shear strength and tensile strength will also be acceptable.
- When using property specification mortars that contain non-conventional ingredients, or are mixed using non-conventional procedures, verify their suitability – mortar adheres completely, gives adequate strength when hardened, and resists the penetration of rain – by testing masonry assemblages constructed with the mortar and grout for:
 - compressive strength (test by CSA A369.1)
 - flexural bond strength (test by ASTM C1072 or UBC Test 24-30 “Bond Wrench”) (Bond is recognized as the most important factor contributing to sound masonry. Minimum of 0.2 MPa (about 30 psi) is considered to provide resistance to water penetration and some assurances of durability. The bond wrench test can be used by the designer to assess compatibility of mortar and unit.)
 - water penetration (test by ASTM E514)

Refer to [Table 2.5a](#), (p. 2-29) for the minimum compressive strength requirements for property specification mortars.

Grout

Select grout type, either:

- fine: for grout spaces narrower (in smallest horizontal dimension) than 50 mm (2 in.)
- coarse: only for grout spaces 50 mm (2 in.) or wider

Grout Mix Design**Proportion Specification:**

As noted, the proportion specification is a simple prescriptive specification wherein the constituent materials and the volumes of these materials are prescribed by the standard. Refer to [Table 2.4b](#), (p. 2-29) for mix design of proportion specification grouts. In addition, the grout must be sufficiently fluid to fill all voids without exhibiting excessive segregation or bleeding.

Property Specification:

Property specification grouts must satisfy the minimum compressive strength requirements in Table 6 of A179 [Table 2.5b](#), (p. 2-29). Grout must be sufficiently fluid to fill all voids without exhibiting excessive segregation or bleeding.

Testing and Test Frequency

Appendix B of the A179 Standard contains tables summarizing the required tests and their recommended frequency to ensure mortar and grout quality control at each stage of construction (prequalification; preconstruction; construction).

Construction compliance testing for proportion specification mortars and grouts deserves comment.

To verify compliance of proportion specification mortars, the A179 Standard specifies that the aggregate-to-cementitious material ratio test is to be conducted. To verify compliance of proportion specification grouts, the A179 Standard specifies that the standard concrete compression strength test using the non-absorbent cylinder mould (identical to that used to test concrete compressive strength) is to be conducted.

The standard specifies that these tests are to be performed periodically throughout the course of construction. It is worth noting that both tests are *non-mandatory* by the standard and are not often specified by the designer, since the proportion specification is simple, and it is reasonable to assume that the masonry contractor is capable of following the specification. Moreover, compliance can be verified by simply observing the contractor as the mortar or grout is proportioned and mixed on the job site. In fact, imposing compressive strength testing, that is, imposing a performance requirement, contradicts the fundamental philosophy of proportion specification, which is a simple prescriptive specification, in which the grout is deemed acceptable based on the known properties and proportions of the ingredients. As such, the contractor is told what and how much to put in; there is therefore little justification in demanding a minimum compressive strength. However, where the designer chooses to use the non-absorbent cylinder mould compressive strength test, the A179 Standard cautions the designer not to expect grout strengths greater than about 10 to 12 MPa (1450 to 1750 psi). These strengths are recognized by S304 and S304.1. Moreover, because of moisture absorption from the grout by the masonry units, the compressive strength of the grout in the constructed masonry will be in the order of 20 MPa (2900 psi).

CONSTRUCTION

The mortar mixing period should be 3 to 5 minutes; mixing times longer than 5 minutes greatly increase the air content and decrease the compressive strength and bond strength of the mortar.

The mixing period for grout should be 5 to 10 minutes.

Mortar should not be retempered after 2½ to 3 hours, as bond strength drops significantly after this delay, and water leakage through the constructed masonry may increase dramatically.

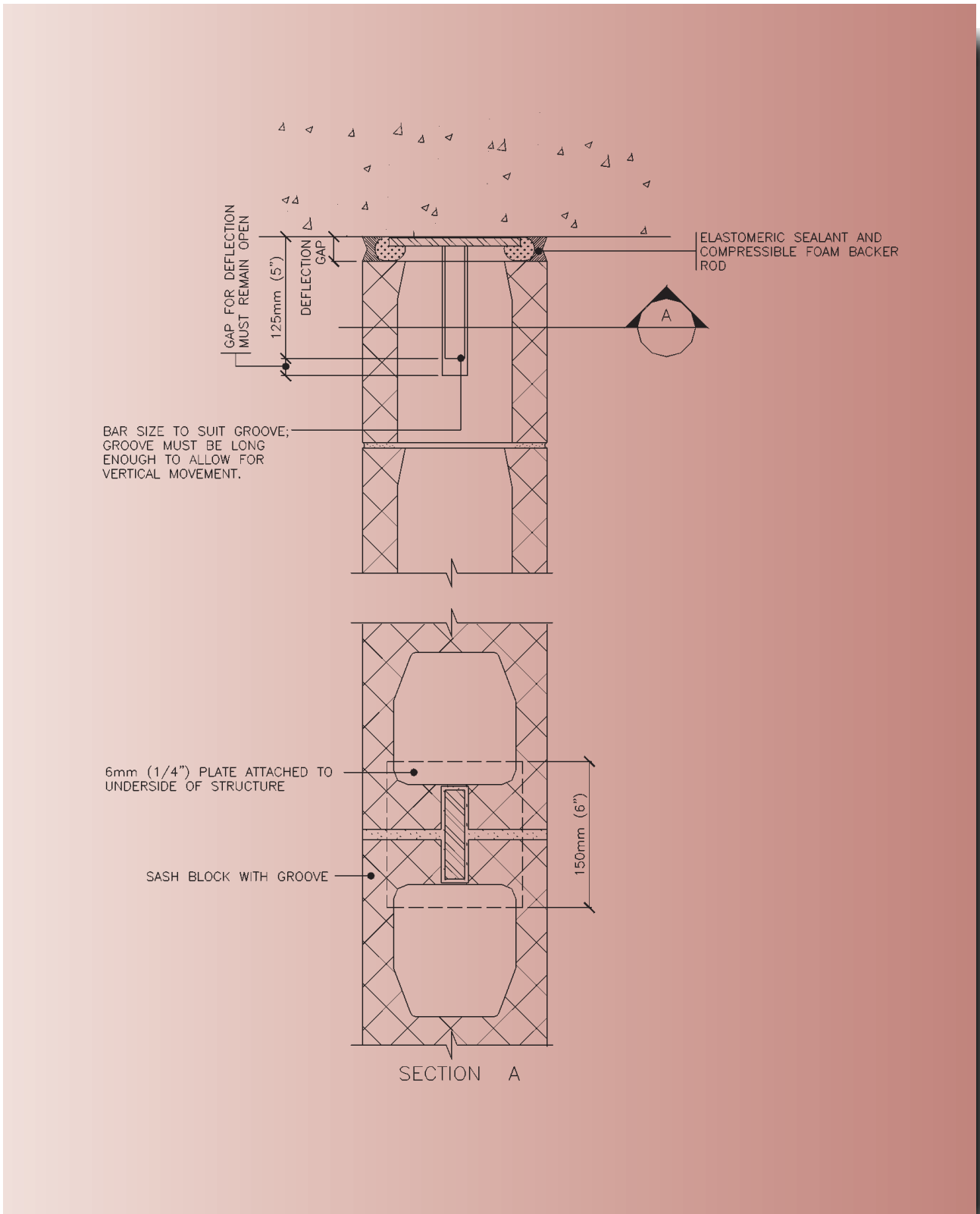
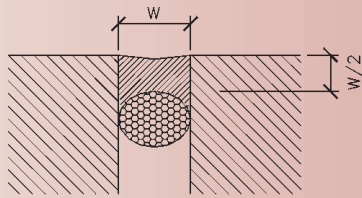

Figure 2.9: Lateral Support Anchor

BEST TIME TO APPLY SEALANT IS
SPRING/FALL TO AVOID LARGE
TEMPERATURE SWINGS DURING CURING



DEPTH-TO-WIDTH RATIO
DIMENSIONAL RELATIONSHIP OF JOINT

TYPICAL "DOG-BONE" SHAPE

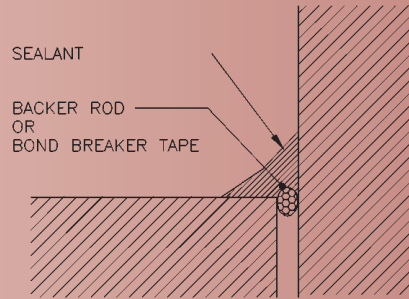

FILLET JOINT

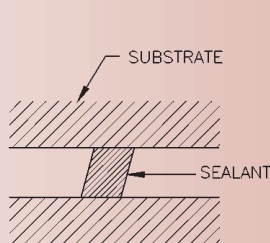

WINTER

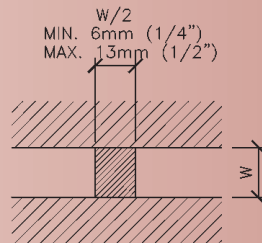

SPRING
LAP JOINT

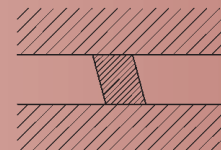

SUMMER

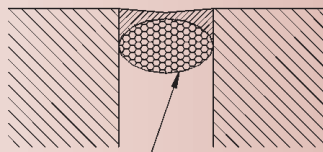

BACKER ROD
WINTER

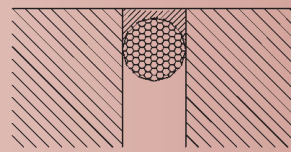

SPRING/FALL
BUTT JOINT

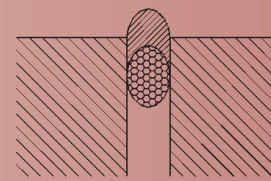

SUMMER

Figure 2.10: Sealant Joints

In accordance with CSA A371, “Masonry Construction for Buildings”:

- a) make joints concave to provide the best resistance to weathering refer to [Figure 2.3](#) (p.2-13)
- b) limit joint thickness to 10 mm ± 3 mm (0.4 in. ± 0.125 in.)
- c) ensure that head and bed joints are full, with mortar compacted into a weathertight joint
- d) satisfy recommended cold weather and hot weather requirements

The compatibility of masonry units and mortar can be measured by bond wrench testing. See Clause 9 of A179-94. Mortar having high water retentivity should be used with high-suction brick and during hot, dry weather. Mortar having low water retentivity should be used with low-suction brick and during cold weather.

COLD AND HOT WEATHER REQUIREMENTS

Refer to [Tables 2.6, 2.7](#), (p. 2-30) and 2.8, (p. 2-31) for cold weather requirements, to prevent freezing distress to the mortar and grout before set.

Hot weather requirements prevent moisture evaporation from the cementitious materials. When working with mortar or grout in air temperatures higher than 38°C (100°F) or 32°C (90°F) when wind velocity exceeds 13 km/h (8 mph), CSA A371 requires that the spread of mortar beds be limited to 1.2 m, and that masonry units be set within 1 minute of spreading the mortar.

REFERENCE PUBLICATIONS

For more information, consult the following standards.

CSA Standards

A179-94

Mortar and Grout for Unit Masonry

CAN/CSA-A5-93

Portland Cement

CAN/CSA-A8-93

Masonry Cement

A371-94

Masonry Construction for Buildings

CAN3-S304-M84

Masonry Design for Buildings

S304.1-94

Masonry Design for Buildings (Limit States Design)

CAN/CSA-A23.2-M90

Methods of Test for Concrete

CAN/CSA-A369.1-M90

Method of Test for Compressive Strength of Masonry Prisms

ASTM Standards

E514-86

Standard Test Method for Water Penetration and Leakage Through Masonry

C207-91 (1992)

Hydrated Lime for Masonry Purposes

Table 2.4a: Proportion Specifications for Mortar

Portland Cement – Lime Mortars				
Mortar type	Parts by volume			Aggregate measured in damp, loose state
	Portland Cement	Hydrated lime or lime putty		
S	1	1/2		3 1/2 to 4 1/2
N	1	1		4 1/2 to 6
or				
Masonry Cement Mortars				
Mortar type	Portland Cement	Parts by volume		Aggregate measured in damp, loose state
		Masonry Cement*		
		N	S	
S	1/2	1	—	3 1/2 to 4 1/2
S	0	—	1	2 1/4 to 3
N	0	1	—	2 1/4 to 3

Source: Reproduced from CSA A179-94
Notes: * Masonry cement satisfying the requirements of CSA Standard CAN/CSA-A8-M.
 1. See CSA A179-94, Appendix A guidelines to mortar selection.
 2. In accordance with CSA A179-94, Clause 6.1.3, as the basis for proportioning, one cubic metre of damp, loose sand contains 1280 kg of dry, loose sand.

Table 2.4b: Proportion Specifications for Grout

Grout Type	Parts by Volume		Aggregate measured in damp, loose state	
	Portland Cement	Hydrated Lime or Lime Putty	Fine Aggregate (Sand)	Coarse Aggregate
Fine Grout	1	0 to 1/10	2 1/4 to 3 times the sum of the cementitious materials	0
Coarse Grout	1	0 to 1/10	2 1/4 to 3 times the sum of the cementitious materials	1 to 2 times the sum of the cementitious materials

Source: Reproduced from CSA A179-94
Note: A superplasticizer may be used to assist with placement of grout, but the requirements of CSA A179-94, Clause 5.5.1.4 must then be satisfied.

Table 2.5a: Property Specifications for Mortar

Preparation	Mortar type	Minimum compressive strength (MPa) (psi) of Mortar Cubes	
		7 d test	28 d test
Laboratory prepared, mixed to a flow of 100–115%	S	7.5 (1090)	12.5 (1812)
	N	3 (435)	5 (725)
Job prepared or manufactured off-site in a batching plant, mixed to a flow suitable for use in laying masonry units	S	5 (725)	8.5 (1230)
	N	2 (290)	3.5 (507)

Source: Reproduced from CSA A179-94

Notes:

1. The age at test, 7 d or 28 d, refers to the length of time since the fresh mortar was sampled.
2. The minimum compressive strength requirements for laboratory-prepared mortars and job-prepared or off-site prepared mortars differ; the latter two are normally about two-thirds the value of the former. Laboratory-prepared mortars are mixed with a quantity of water to produce a flow of 100–115%. This quantity of water generally is not sufficient to produce a mortar with a workable consistency suitable for laying masonry units in the field. Flow values of 130–150% are common for mortar in construction. Mortar for use in the field must be mixed with a maximum amount of water, consistent with workability, to provide sufficient water to satisfy the suction of the masonry units. Compressive strength values for job-prepared mortars or mortars manufactured off-site in a batching plant can therefore normally be expected to be less than those for laboratory-prepared mortars, because construction mortar contains more water. The strength of laboratory-prepared mortar is intended to approximate that of field-prepared mortar after it has been in use and unit suction has been satisfied.
3. Ready-mixed mortar should be tested only at 28 days. The 7-day test results may be affected by the extended-life admixture.
4. For information about accelerated curing, and mortar cube testing at 24 hours, see Note 3 of CSA A179-94, Clause 8.3.1.
5. Guidance on testing and test frequency is provided in CSA A179-94, Appendix B.

Table 2.5b: Property Specifications for Grout

Grout Type	Consistency, when sampled	Minimum Compressive Strength, (MPa) (psi)	
		7 d test	28 d test
Fine	Suitable for use	6.0 (870)	10.0 (1450)
Coarse	in grouting masonry	7.5 (1090)	12.5 (1812)

Source: Reproduced from CSA A179-94

Note: A superplasticizer may be used to assist with placement of grout; but the requirements of CSA A179-94, Clause 5.5.1.4 must then be satisfied.

Table 2.6: Protection Requirements for Cold Weather Work

Mean daily air temperature °C (°F)	Protection
0 to 4 (32 to 40)	Masonry shall be protected from rain or snow for 24 hours by means of cover with plastic or canvas sheets.
-4 to 0 (25 to 32)	Masonry and masonry materials shall be completely covered for 24 hours to prevent wetting and freezing.
-7 to -4 (20 to 25)	Masonry shall be completely covered with insulating blankets for 24 hours.
-7 and below (20)	The masonry temperatures shall be maintained above 0°C (32°F) for 24 hours by enclosure and supplementary heat.

Source: CSA A179-1994

Notes:

1. Wind chill factors and size and shape of the structure must be considered in determining the amount of insulation required to properly cure masonry. Please refer to Table 2.7 for wind chill factors.
2. The protection period, as set forth above, shall be increased from 24 to 48 hours unless high-early-strength portland cement, Type 30, in accordance with CSA Standard CAN/CSA-A5, and Type S hydrated lime are used in mortars and grouts. Where Types N and O mortars are used, all protection periods shall be increased by 24 hours.

Table 2.7: Wind Chill Factors

Estimated wind speed in k/h(m/h)	Actual thermometer reading °C							
	-1	-7	-12	-18	-23	-29	-34	-40
Calm	Equivalent temperature							
8 (5)	-1	-7	-12	-18	-23	-29	-34	-40
16 (10)	-3	-9	-14	-21	-26	-32	-38	-44
24 (15)	-9	-16	-23	-33	-37	-43	-50	-57
32 (20)	-13	-21	-28	-35	-43	-50	-58	-65
40 (25)	-16	-23	-31	-39	-47	-55	-63	-71
48 (30)	-17	-26	-34	-42	-51	-59	-67	-75
56 (35)	-19	-28	-36	-45	-53	-62	-69	-78
64 (40)	-20	-29	-37	-47	-55	-63	-72	-81
Wind speeds greater than 60 k/h (40 m/h) have little additional effect	-21	-30	-38	-48	-56	-64	-73	-82

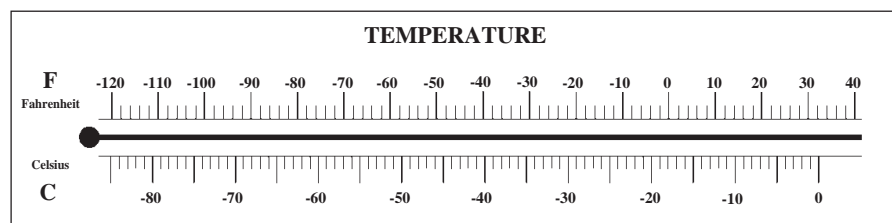

Table 2.8: Construction Requirements for Cold Weather Work

Mean Daily Temperature °C (°F)	Construction Requirement
Above 4 (40)	Normal masonry procedures.
0 to 4 (32–40)	Heat mixing water to produce mortar temperatures between 5–50°C (40–120°F).
-4 to 0 (25–32)	Heat mixing water and sand to produce mortar temperatures between 5–50°C (40–120°F).
-7 to -4 (20–25)	Mortar on boards should be maintained above 5°C (40°F).
-7 and below (20)	Heat mixing water and sand to produce mortar temperatures between 5–50°C (40–120°F).

CONNECTORS

“Connector” is the general term for ties, anchors and fasteners used in masonry construction. Field studies find that the performance of the masonry wall system is highly dependent on the long-term performance of masonry connectors. The designer must design and select connectors for a masonry element based on the following criteria:

- connector function
- durability (corrosion protection)
- strength (compressive, tensile, shear, as well as minimum strength and in-service requirement)
- serviceability (free play, stiffness, positive restraint, ability to accommodate differential movement where required by the design)
- constructability (ease of placement, interfacing with other components of the system, ease of adjustment in all three directions)
- cost (of the connector and installation)

COMPLIANCE

CSA Standard A370, “Connectors for Masonry,” provides the design requirements for masonry connectors used in Canada. It recognizes three types of masonry connectors:

- conventional connectors
- non-conventional connectors
- repair connectors

Although not explicit in Standard A370, two distinct compliance paths result from the way these three connector types are defined. A **prescriptive compliance** path, for conventional connectors, and a **performance compliance** (or engineered compliance or rational design compliance) path, for non-conventional and repair connectors.

Repair connectors are a sub-set or special application of the non-conventional connector. Requirements for repair connectors are contained in Standard A370, Clause 11. Repair connectors, used in restoration and repair, are not discussed in this guide.

Conventional Connectors

Conventional connectors have been in general use for decades in masonry and have demonstrated their effectiveness under certain environmental conditions and loadings. They are listed in Standard A370, Clause 9, and most are illustrated in Appendix B of the standard (figures B1 to B10). Conventional connectors include:

- corrugated strip ties
- Z-wire ties [Figure 2.4](#), (p. 2-14)
- rectangular wire ties [Figure 2.4](#), (p. 2-14)
- continuous ladder and truss ties/reinforcing [Figure 2.5](#), (p. 2-17)
- dovetail anchor/ties [Figure 2.4](#), (p. 2-14) and [Figure 2.7](#), (p. 2-21) and bar anchors [Figure 2.13](#) (p. 2-41)

Typically, conventional connectors are single-component connectors with little or no capacity for adjustment along either plane; yet such capabilities are always needed during placement to accommodate construction tolerances. In general, conventional connectors are suitable for low-rise masonry cavity-wall construction where the foreseeable construction tolerances are minimal. They are unsuitable for use in high-rise construction, or where a structural backing other than masonry is used.

In the construction of masonry cavity walls in Canada, the use of connectors is based on the following:

- Strip ties are not used.
- Z-wire ties and rectangular wire ties are no longer used.
- Continuous truss ties/reinforcing are used only in low-rise construction and where expected construction deviations from theoretical plan and elevation are minimal.
- Dovetail anchor/ties are commonly used to tie masonry veneer to concrete backing, and over concrete beams and columns in masonry cavity-wall infill panels. Full vertical adjustability is provided by the slot, and adjustment normal to the wall is obtained by using varying tie lengths.
- Bar anchors are commonly used at the intersection of masonry walls.

The A370 Standard prescribes the configuration of each connector and the structural and constructed environments to which each is suited. Clause 9 outlines manufacturing requirements for each conventional connector and circumscribes the conditions in which each should be used. CSA Standard A371, “Masonry Construction,” deals with matters related to connector placement and installation.

The material, thickness, configuration and placement of the connector cannot deviate from those described in the standards. If the configuration is not in strict compliance, then, by definition, the connector is not a conventional connector. If the connector has even a small modification or if it fails to meet the design and placement requirements for conventional connectors, it is a non-conventional connector and subject to the performance standards applicable to non-conventional connectors. However, it can still be used in construction.

In addition to Clause 9 requirements, a conventional connector must satisfy the requirements outlined in Table 2.9.

Table 2.9: Standards for Conventional Connectors

Parameter	Clause	Rationale
Materials and coatings	Clause 3	durability
Corrosion protection	Clause 4	durability
Maximum permissible spacings	Clause 6	ensures acceptable interaction between the masonry and the connector; determines service loadings
Source: CSA Standard A370		

The use of conventional connectors under this prescriptive compliance path offers simplicity of design, but with some limitation.

Non-conventional Connectors

Non-conventional connectors may be variations of the conventional connectors described in A370, Clause 9, or they may be completely different. Non-conventional connectors must satisfy a performance compliance path and the prescriptive requirements outlined in Table 2.10.

Table 2.10: Standards for Non-conventional Connectors

Parameter	Section	Rationale	Type of Requirement
Materials and coatings	Clause 3	related to durability	prescriptive
Corrosion protection	Clause 4	related to durability	prescriptive
Thickness	Clause 5	ensures acceptable interaction between the masonry and the connector	prescriptive
Maximum permissible spacings	Clause 6	ensures acceptable interaction between the masonry and the connector; determines service loadings	prescriptive
Minimum strength	Clause 7	needed for robustness	prescriptive
Ultimate strength	Clause 8		performance
Serviceability: • tie displacement and free play • positive restraint	Clause 8		performance
Design methodology (WSD or LSD)	Clause 8		performance
Structural integrity	Clause 8		performance
Source: CSA Standard A370			

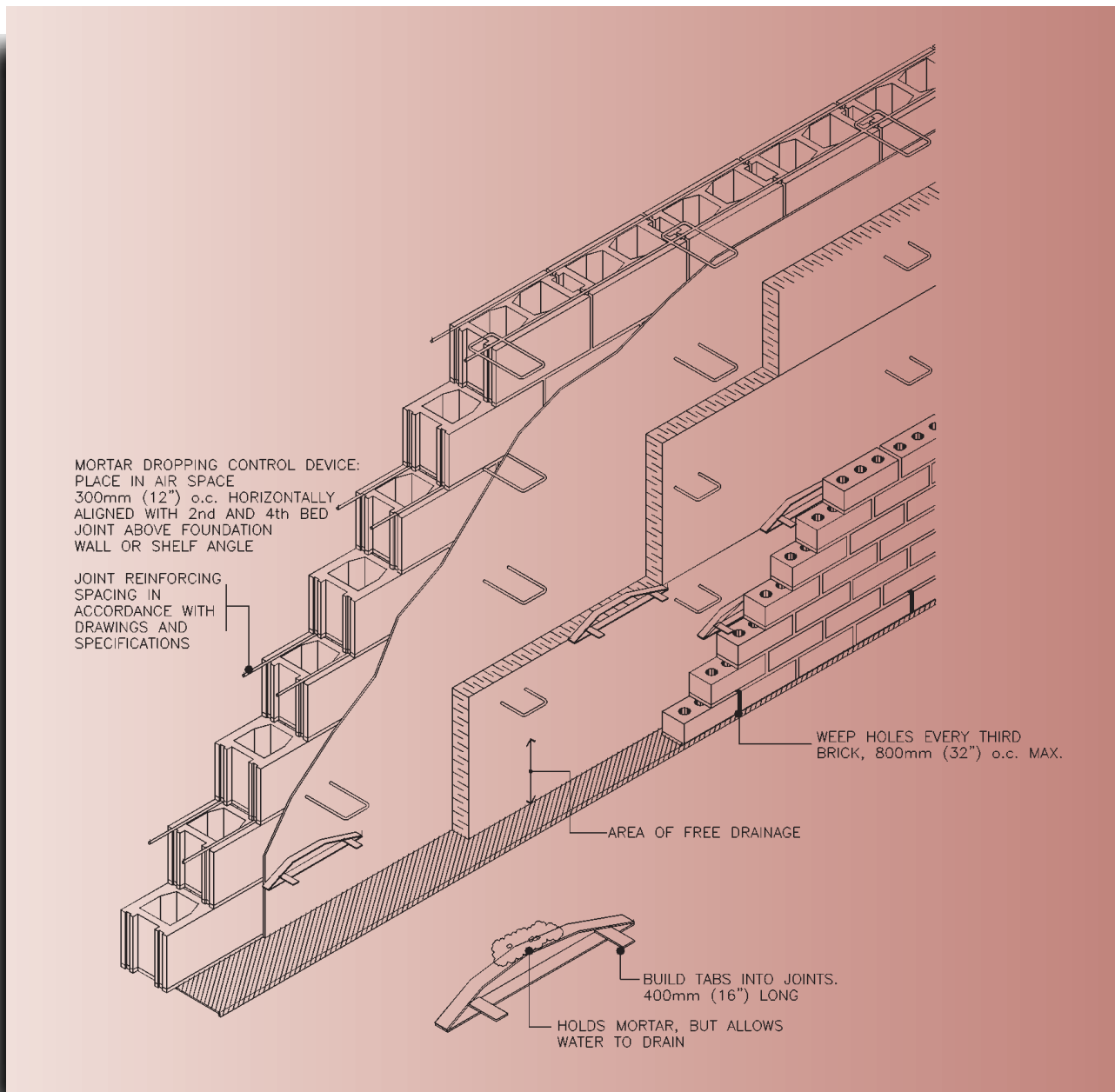

Figure 2.11: Mortar-dropping Control Device

Non-conventional connectors are engineered connectors, best suited for engineered masonry. They are typically multi-component connectors and are meant to facilitate the design and installation of masonry in modern masonry structures by providing:

- constructability (ease of installation and adjustability in the vertical direction and normal to the wall needed to accommodate construction tolerances, and effective interaction with the other components of the masonry wall system)
- performance (quantified, documented and verified by the manufacturer)

CONNECTOR FUNCTION

Ties

The basic function of a masonry tie is to connect different wythes of a masonry wall together. Relative to anchors, masonry ties are light-duty connectors and are placed at frequent intervals to give structural support to the masonry wythes. The tie serves a variety of functions: it may simply attach a masonry veneer to its structural backing; it may tie the wythes together for enhanced structural stability of load-bearing masonry; or it may serve as a shear connection between the wythes so that composite action is provided to resist lateral loads (and vertical loads if the walls are load-bearing). To serve its function, a wall tie must have the necessary structural capabilities.

In general, masonry ties must have the ability to:

- transmit tension and compression without excessive deformation
- allow vertical differential movement between veneer and structural backing, or, in the case of composite ties, transmit shear forces
- perform satisfactorily during fire
- resist corrosion and other forms of degradation
- resist passage of water from the exterior masonry wythe to the inner structural backing
- offer as small an area as possible to capture mortar droppings
- allow adjustability in all three directions to accommodate construction and manufacturing tolerances
- allow retention of insulation where required
- provide the least interference possible in the installation of other components of the wall system, including the air barrier, vapour barrier and insulation
- prevent disengagement in service
- be economical

Non-conventional adjustable ties are best suited to modern masonry construction. Adjustable ties are made from two or more components and in some manner provide for vertical adjustment to facilitate any non-alignment of mortar bed joints between the exterior masonry wythe and the masonry backing. Adjustment normal to the wall is obtained by using a different length for at least one of the components of the tie system, normally the component embedded in the exterior masonry wythe. Adjustability normal to the wall is essential, since CSA Standard A371 requires that masonry ties engage the exterior wythe of masonry along the centre line of the wythe within a tolerance of only 13 mm (0.5 in.). Two types of ties in common use are illustrated in [Figures 2.5](#), (p. 2-17) and [2.6](#), (p. 2-18).

Multicomponent composite ties (or shear connectors), a type of non-conventional masonry tie, transfer lateral loads between the exterior masonry wythe and its structural backing through axial tension/compression and vertical shear; they transfer vertical loads through vertical shear, even where a cavity exists. Conventional ties and most non-conventional ties simply transfer lateral loads between the two wall elements through axial tension and compression and do not resist vertical shear. In composite ties the wall system performs as a vertically oriented truss; the ties serve as the webs of the truss, while the exterior masonry wythe and its backing act as the tension and compression chords. Total wall strength and stiffness are therefore

greater than the sum of the strength and stiffness of the individual wythes. Composite action can reduce the thickness requirement of the structural backing wall. Other benefits include reduced deflection and reduced width and frequency of micro-cracking. Because the composite tie provides vertical rigidity, the designer should assess the potential for internal stresses generated by any differential movement between the elements being connected, movement that might result from the effects of temperature and moisture. The manufacturer of the ties should be consulted on appropriate design and use.

Anchors

The basic function of a masonry anchor is to connect large masonry elements to their supports or to other structural members or to intersecting walls. Masonry anchors are for heavier duty than masonry ties and are placed at less frequent intervals.

Lateral support anchors are commonly used in masonry construction to provide lateral support along the perimeter of masonry walls at the wall top or sides. Some different methods to support masonry infill walls are illustrated in [Figures 2.8](#), (p. 2-22) and [2.9](#), (p. 2-25), in addition to steel clips illustrated in [Detail 4.3](#), (p. 4-31).

Fasteners

The basic function of a masonry fastener is to secure masonry ties and anchors to the structural backing and/or to the masonry element being supported.

CSA A370 REQUIREMENTS FOR CONNECTORS

Connector Materials and Thickness

The following materials are recognized by CSA A370, and are generally used to manufacture masonry connectors:

- steel wire
- steel sheet and strip
- steel bars, plates and angles
- steel bolts

Steel grade or type is further defined in Clause 3. Material thickness limitations are stated in Clause 5.

Although CSA A370 permits the use of other materials, including plastics, in the manufacture of connectors, it stipulates that they must have durability (corrosion resistance) equivalent to that prescribed by the standard; however, the standard does not detail how this equivalency is to be verified.

Clause 3 further requires that connectors be shaped so as not to trap water and so that they can be easily embedded in masonry without forming voids. Connectors should not be configured in such a way as to present channels that facilitate the passage of water through masonry or across the masonry cavity. Masonry ties should not be crimped, since it has been shown that crimping reduces the compressive strength of ties by about 50% and traps moisture, accelerating corrosion.

Connector Corrosion Protection

Connectors must have an adequate level of corrosion protection to enable them to perform effectively (maintain strength, stiffness, function) for the design service life of the assembly. Design service life of a wall can vary depending on its individual function and requirements. For most institutional and high-rise buildings, the design service life of the wall system should be assumed to be approximately 50 years, in the absence of more definitive information. (For additional information, see CSA S478-95, “Guideline on Durability in Buildings.”)

Typically, masonry connectors are embedded in mortar or grout, but they usually have some part exposed to the atmosphere between the wythes. If the exposed portion of the connector is made of steel, it will corrode in climates where moisture is abundant. The rate of corrosion is greatly increased by pollutants found in urban and industrial settings. Corrosion may also be more rapid if two dissimilar metals, such as stainless steel and zinc, are in contact with each other in the presence of moisture. Although the embedded end of the connector is protected by mortar, corrosion can still occur if the mortar becomes acidic or contains significant amounts of chloride ions. Unfortunately, the mortar eventually becomes acidic as a result of carbonation – the chemical process by which the lime is set in the mortar. And chloride ions may enter the mortar from the environment.

Thus, the conditions that influence the risk and rate of corrosion eventually become the same inside the walls as those in the cavity. And these are the same as for atmospheric conditions.

In practice, the environment of a masonry connector is difficult to predict. But it is known that the greatest influence on durability is time of wetness. If rain does not penetrate the masonry, corrosion will only be slight. Unfortunately, no information is available that conveniently divides Canada into regions of severity of environment. The Annual Rain Index Map of Canada [Figure 2.17](#), (p. 2-57), however, is used by the A370 Standard as the best reference for relating environment to corrosion protection for masonry connectors. It provides some measure of the severity of attack by rain on a wall surface and potential for water penetration. This is a simplification of the environment of the connector, which is a function not only of the macro-environment (climate, orientation of the building, height on the building, size and shape of the building and its exposure, exposure to pollutants), but also is a function of the micro-environment (exposure of components to water because of air leakage, vapour diffusion, maintenance procedures, etc., protection by, and embedment in, surrounding mortar, shape of the tie, etc., contact with other incompatible materials).

Requirements for corrosion protection of connectors are contained in Table 2 of the CSA A370 Standard [Table 2.12](#), (p. 2-47). Minimum corrosion protection levels, I, II or III, are assigned to connector types based on the exposure environment and connector use:

- Level I Corrosion Protection: Unprotected carbon steel or zinc coating less than that outlined in Table 3 of A370.
- Level II Corrosion Protection: Carbon steel that is hot dip galvanized after fabrication to at least the minimum standards of Table 3 of CSA A370. Other materials with proven equivalent corrosion protection may be used.
- Level III Corrosion Protection: Stainless steel type 304 or 316. Other materials with proven equivalent corrosion protection may be used.

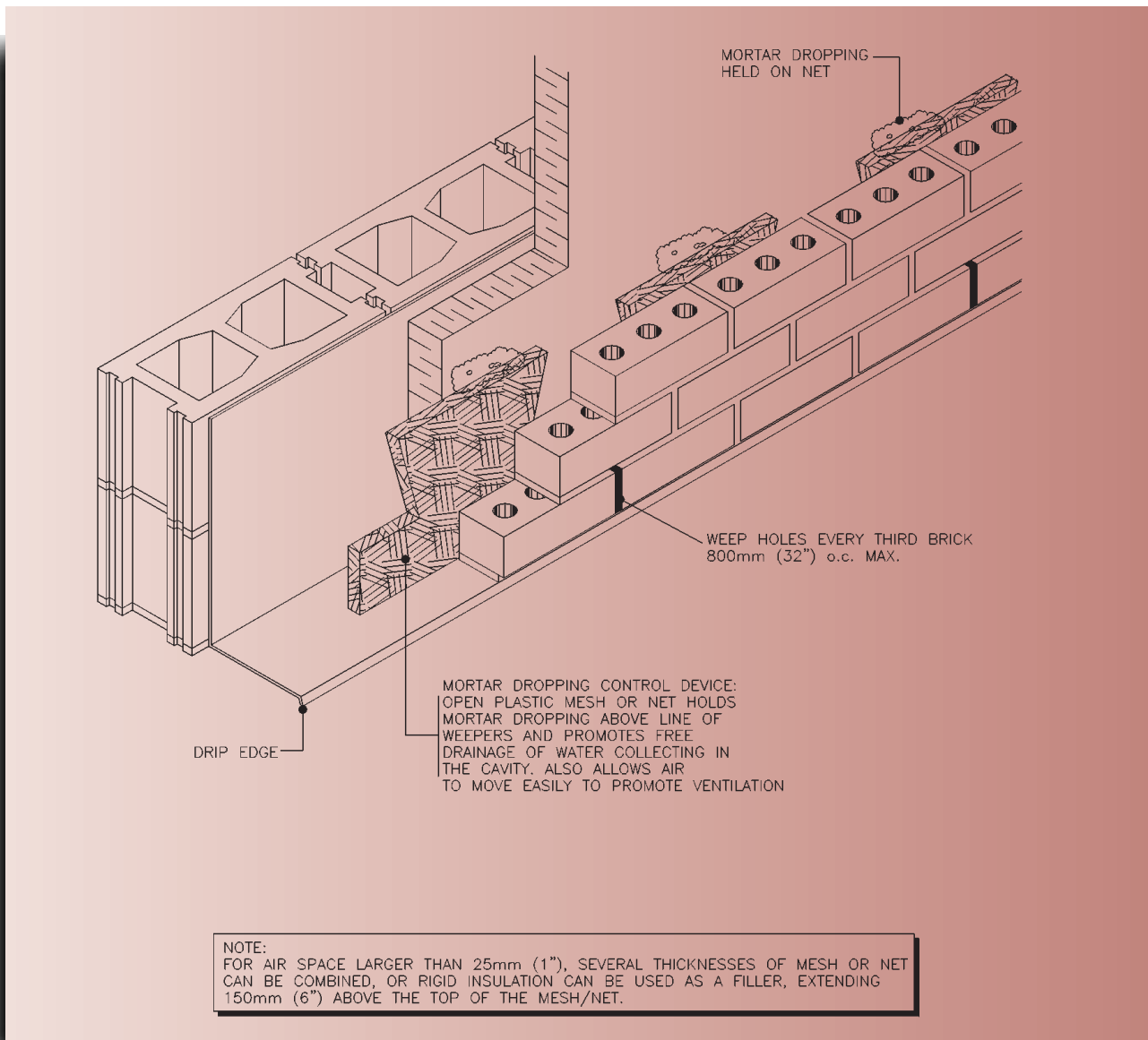

Figure 2.12: Mortar-dropping Control Device (High-density Polyethylene)

By the CSA A370 Standard, masonry shelf angles and secondary support framing are NOT considered to be masonry connectors and therefore, strictly speaking, the requirements of A370 do not apply to these elements. However, because there exists interaction between masonry veneer and shelf angles forming part of the wall system, the shelf angles must satisfy certain needs and requirements for the masonry it supports; hence masonry design will influence the design criteria for the shelf angle. It is reasonable to state that:

- strength requirements for the shelf angles will be based on steel design
- serviceability requirements will be based on both steel design requirements and those for masonry veneers outlined by CSA Standard S304.1

- corrosion protection requirements for shelf angles should be based on:
 - a performance requirement (Clause 4.1 of A370)
 - demonstrated effectiveness of shelf angles in existing buildings exposed to similar climatic conditions and service environments as for the building under consideration, considering both the performance of shelf angles in the area and possible failure mechanisms (e.g., shelf angle was subjected to large amounts of moisture resulting from a poor air barrier in the building; failure to adhere continuous flashing to the angle with appropriate seams and overhangs; poor workmanship)
 - guidance as to minimum level of corrosion protection (Clause 4.2.1 of A370)
 - guidance contained in Table 2 of A370

Aside from the mandated requirements for the minimum level of corrosion protection contained in CSA A370, the following factors should be considered before selecting the level of corrosion protection for masonry connectors:

- design service life of the building
- design service life of the system containing the masonry element to be connected
- exposure of the masonry element to wetting
- location of connector within the masonry element
- pollutants in the air from the exterior and interior of the building
- contaminants
- access for inspection, maintenance and replacement
- consequences of failure

The following additional factors should be considered when assigning corrosion protection level:

- Corrosion protection requirements noted above and in CSA A370 are the minimum required and may not provide a service life of 50 years, depending on the severity of the service environment.
- Good detailing and construction of the masonry element to keep water penetration to a minimum will extend the service life of a connector.
- Direct contact between dissimilar metals in the presence of moisture, initiating galvanic corrosion, should be avoided.
- Connectors embedded in masonry wythes must be fully embedded in mortar, and a minimum of 16 mm (0.75 in.) mortar cover is recommended.
- The cost of providing superior protection is nominal. It has been estimated that doubling the cost of masonry ties will increase the cost of brick masonry in high-rise construction by about 2 to 3%. Cost of stainless steel masonry ties is approximately two times that of hot-dipped galvanized steel ties.

Connector Spacing

Masonry connectors are subject to the wind and earthquake loads that are being resisted by the masonry element they support. The magnitude of loadings and placement of the loadings on the building and building elements should be calculated in accordance with Part 4 of the *National Building Code of Canada*.

For non-conventional connectors, connector spacing is determined by rational engineering analyses (in accordance with the procedures and requirements of CSA S304.1, “Masonry Design for Buildings”) of the connector-masonry interface and of the masonry being supported by the connectors. The engineering properties of the masonry and of the connectors are defined by CSA S304.1 and by CSA A370, respectively. Unless detailed analyses are undertaken, regardless of connector strength and wall configuration, connector spacings must not exceed those stated in [Table 2.10](#), (p. 2-33), which summarizes the prescriptive spacing requirements for masonry ties and masonry wall anchors contained in CSA A370. The stated tie spacings are largely qualitatively based on industry experience, tempered by the restrictions of modular spacing. In addition, they apply to masonry veneers that are 75–90 mm (3½ in.) thick. Thus, the qualification clause, except as noted in CSA S304.1, permits the designer to address larger spacings for increased veneer thicknesses.

To use conventional connectors under the prescriptive compliance path, the imposed loads calculated must not exceed the limits stated in Clause 9.3 of the A370 Standard reproduced as notes to [Table 2.13](#), (p. 2-48). Where these limits are not exceeded, the maximum spacing for each conventional connector is prescribed by the A370 Standard:

- for conventional ties securing a continuous masonry wythe not adjacent to discontinuities, by a table in Clause 9 for each tie as a function of cavity width
- for conventional anchors, by the requirements of Clause 6.2 in CSA A370 and Clause 5.5 of CSA A371

Where the design calls for conventional connectors but the stated limitations of Clause 9.3 are not satisfied, conventional connectors may still be used provided they satisfy the requirements for the performance compliance path used for non-conventional connectors. [Table 2.11](#), (p. 2-43) summarizes the prescriptive requirements contained in A370 for the maximum spacing of conventional ties both away from and adjacent to discontinuities, and for conventional wall and partition anchors.

Strength and Serviceability

By the A370 Standard, non-conventional connectors must satisfy certain quantitative limits for tie free play, tie stiffness and minimum strength, and some qualitative requirements for positive restraint and integrity. When specifying a non-conventional masonry wall tie, the designer should seek engineering data from the manufacturer sufficient to demonstrate compliance with the new A370 Standard.

Conventional connectors will satisfy the free play, stiffness, minimum strength and positive restraint requirements when used in strict accordance with the provisions of Clause 9 of the A370 Standard and the installation requirements in the A371 Standard. Consideration must be given to the integrity requirements during both design and construction.

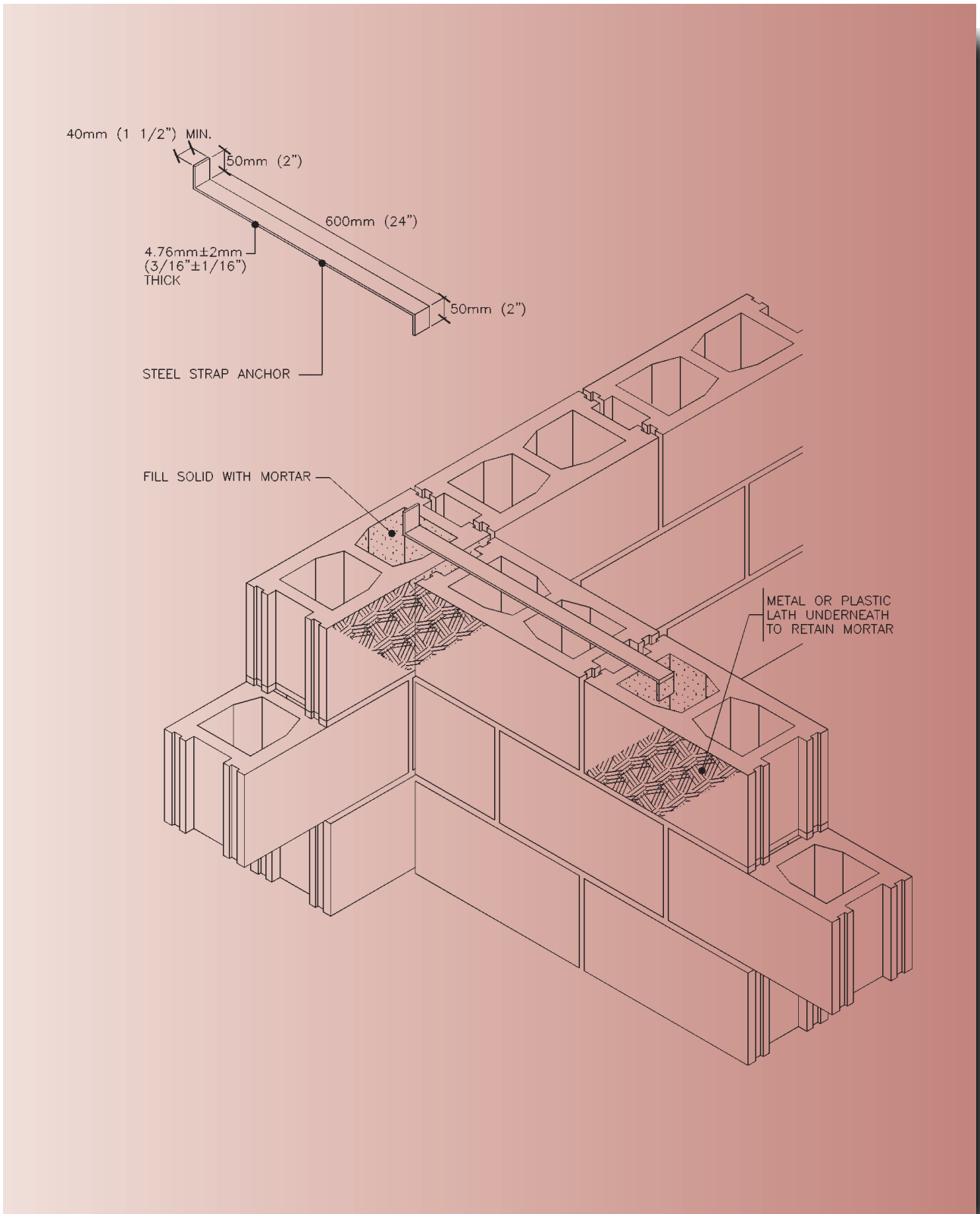

Figure 2.13: Anchorage of Intersecting Walls (Type 1)

Tie Free Play and Tie Stiffness

The free play of a tie is the movement in the tie system before it is able to resist loading. For example, in an eye-pintle multicomponent tie system, the difference between the size of the eye and the diameter of a wire pintle is the free play. Tie free play must not exceed 1.2 mm (0.05 in.).

The stiffness or displacement is a measure of how much the tie system deforms under a compressive or tensile load. The CSA A370 requirement does not separate stiffness from free play; rather, when the tie is tested under a compressive and tensile load of 450 N (100 lb.), the sum of the displacement and free play must not exceed 2 mm (0.08 in.).

Displacement includes all secondary deformations of the structural backing (such as fastener slippage, flange rotation, bending, compression of insulation or sheathing), but it DOES NOT include primary deflection of the structural backing.

For adjustable ties, free play and stiffness limits must be satisfied at all positions of adjustment. Stiffness and displacement limits for tie systems are necessary to avoid excessive displacement and minimize cracking of the masonry exterior wythe.

Minimum Strength

To provide robustness, the ultimate strength of a tie must not be less than 1000 N (225 lb.), and the ultimate strength of a wall or partition anchor must not be less than 1300 N (300 lb.).

Structural Integrity

Ties must be capable of transferring both tension and compression. If composite ties are used, the composite ties should be able to transfer tension, compression and vertical shear. Intervening materials between masonry ties or anchors and the primary support system must be capable of transferring the imposed loads safely and within serviceability limits, and must be capable of doing so throughout the design service life of the wall. The latter requirement within the standard (Clause 8.5) is an objective-based requirement containing neither prescriptive nor performance criteria for compliance. It is related to durability and since durability of materials and components is not an intrinsic property, and since durability is dependent on the service environment (which is often difficult to define), it is thus difficult to verify compliance. Clearly, however, the placement of a tie against compressible insulation without means to transfer load to the primary backing is not acceptable.

Positive Restraint

Adjustable ties must also provide positive restraint at the positions of maximum adjustment. This will help ensure that the mason engages the tie at the time of installation, and that the tie is not easily disengaged in service by differential movements.

Table 2.11: Maximum Permissible Spacings for Masonry Ties and Masonry Wall Anchors by CSA Standard A370

Connector Type	Tie		Wall Anchor	
	Away from Discontinuities	Adjacent to Discontinuities	Adjacent to Discontinuities	Away from Discontinuities
Non-conventional	Except where permitted by CSA S304.1: <ul style="list-style-type: none"> • 600 mm (24 in.) vertical • 800 mm (32 in.) horizontal 	<ul style="list-style-type: none"> • at openings, see summary Table 2.14, p. 2-48, and Figure 2.7, p. 2-21 • at top and bottom of walls, see summary Table 2.15, p. 2-49 and Figure 2.7, p. 2-21 	Except where otherwise shown by engineering analysis: <ul style="list-style-type: none"> • at wall tops, 10 × thickness of wythe to be anchored • at wall sides, 4 × thickness of wythe to be anchored • 600 mm (24 in.) in shear walls where anchors must resist vertical shear forces 	N/A
Conventional	See summary Table 2.13, p. 2-48	<ul style="list-style-type: none"> • at openings, see summary Table 2.14, p. 2-48 and Figure 2.7, p. 2-21 • at top and bottom of walls, see summary Table 2.15, p. 2-49 and Figure 2.7, p. 2-21 	<ul style="list-style-type: none"> • at wall tops, 10 × thickness of wythe to be anchored • at wall sides, 4 × thickness of wythe to be anchored • 600 mm (24 in.) in shear walls where anchors must resist vertical shear forces 	N/A

CONSTRUCTABILITY

Although a proprietary masonry wall tie may indeed satisfy the requirements of the A370 Standard with respect to performance, none of the CSA masonry standards contain either prescriptive or performance requirements that relate to assessment of, or compliance for, constructability or buildability. This so-called property of the masonry tie is a qualitative assessment of the ability of the tie to:

- facilitate ease of its placement and the placement of adjacent components forming the complete wall system, by respecting the rational sequence of wall construction
- facilitate ease of its placement by accommodating reasonably anticipated construction variations from theoretical plan, elevation, and plumb
- while performing its structural function, effectively interact with the other components of the assembly by not adversely affecting their installation, function and performance.

The use of ties that do not facilitate construction ultimately diminish the long-term performance of the masonry wall system with respect to resistance to both structural and environmental loadings.

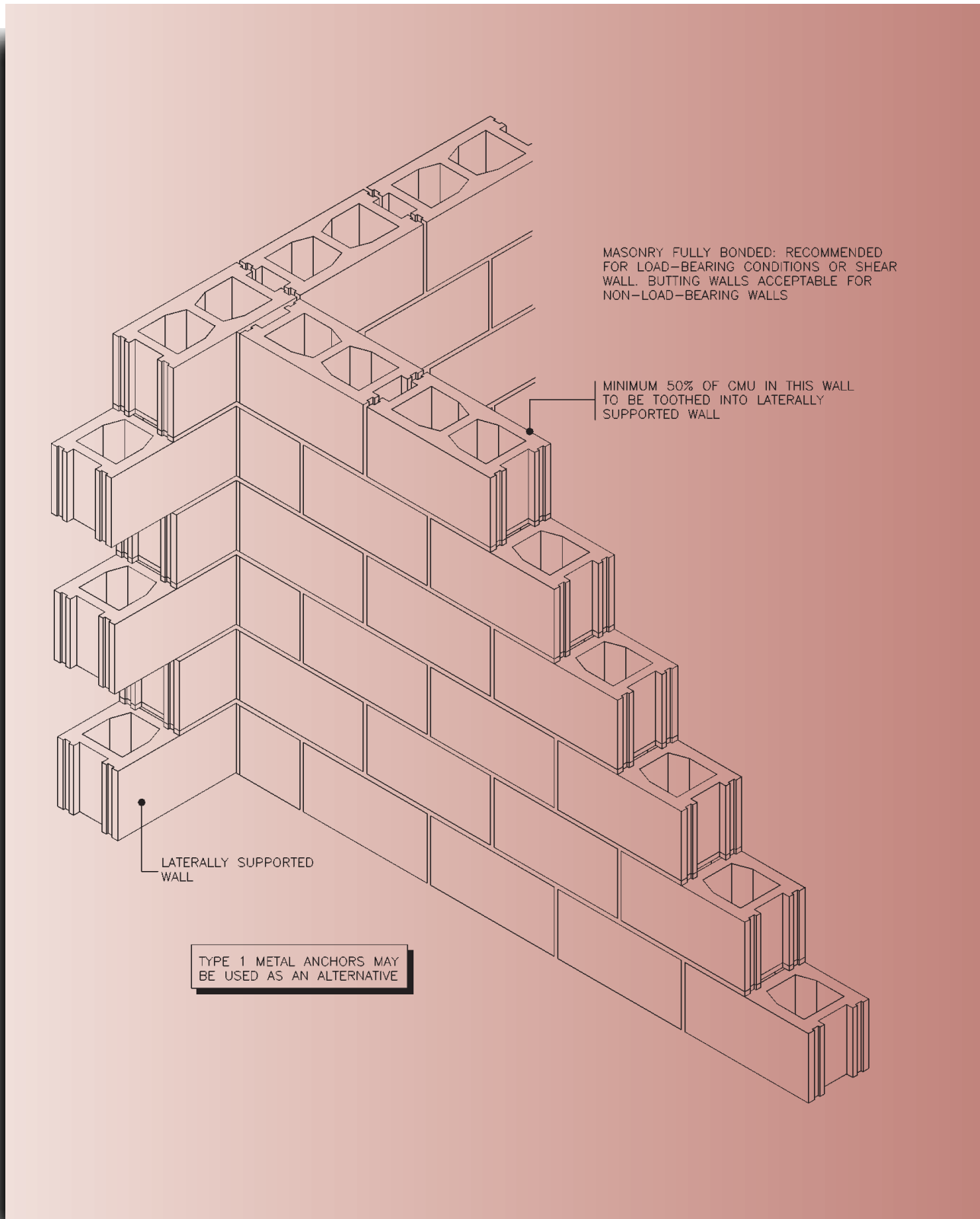

Figure 2.14: Anchorage of Intersecting Walls (Type 2)

COST

The designer is urged to look beyond the initial purchase price of the masonry connector, and to closely examine the initial and long-term savings obtained by using a connector that:

- facilitates construction
- provides enhanced structural performance
- has an extended predicted service life

Initial first cost also includes the cost of installation of the connector, and this will be reflected in the price tendered by the contractor. Indeed, with the high cost of labour today, a “bargain” connector that does not facilitate construction may ultimately be considerably more expensive to supply and install than a connector with a higher purchase price that is more easily placed in the wall by the mason.

Because of the configuration of the connector and the necessary sequencing of construction to facilitate placement, some connectors are more readily inspected than others, and this may affect project cost.

The ability of the connector to interface with other components in the wall assembly may affect the long-term performance of the wall system and therefore the life-cycle cost (considering factors such as maintenance, repair and additional energy costs from heat loss caused by conduction and air leakage).

The enhanced structural performance and associated benefits offered by shear connection of the exterior masonry and its structural backing may greatly outweigh the premium paid for the initial purchase price of the connector.

CHECKLIST FOR MASONRY TIE SELECTION

General Considerations

- height above ground floor
- wind loads
- earthquake loads
- other loads
- exposure grading
- pollutants, contaminants
- cavity width

Type of Tie

- conventional or non-conventional
- adjustability and constructability
- width of cavity

For Non-conventional Ties

- manufacturer engineering and load test data
- manufacturer verification that sum of maximum displacement and free play is less than 2 mm (0.08 in.), and that free play does not exceed 1.2 mm (0.05 in.)

Tie Spacing

- if the building is more than 20 m (65.6 ft.) above ground, tie-spacing calculation based on loading
- if reference velocity pressure is more than 0.5 kn/m² (10.5 psf), tie spacing calculation based on loading
- if ties are subject to soil pressure, earthquake or other loads, calculate tie spacing based on loading
- if none of the above conditions apply, then use maximum tie spacing in [Table 2.11](#) (p. 2-43) for conventional ties
- if none of the above conditions apply, then use recommended spacing by manufacturer or as shown by engineering calculations with maximum spacing limit as stated in [Table 2.11](#)
- openings and other special locations based on data in [Tables 2.14](#), (p. 2-48 and 2.15, p. 2-49)

Corrosion Protection

- exposure grading based on annual rain index [Figure 2.17](#), p. 2-57)
- exposure environment, i.e., whether exposed to moisture or not
- presence of pollutants, contaminants
- access for maintenance and replacement
- connector use (related to interior/exterior use, above grade or below grade, building height)
- connector type
- required level of corrosion protection (Level I, II or III)

REFERENCE PUBLICATIONS

For more information, consult the following standards.

CSA Standards

A370-94

Connectors for Masonry

A371-94

Masonry Construction for Buildings

CAN3-S304-M84 and S304.1

Masonry Design for Buildings

S478-95

Guideline on Durability in Buildings

Table 2.12: Minimum Level of Corrosion Protection for Masonry Connectors

Connector use	Exposure environment ¹	Type of connector	Minimal level of corrosion protection
Interior masonry	• not subjected to moisture	all connectors	I
	• subjected to moisture		II
Masonry below grade (in contact with the ground)	• protected by an impermeable membrane on the face in contact with the ground	all connectors	I
	• in non-aggressive soils		II
Exterior masonry above grade, in buildings less than 11 m in height ²	• in areas of “sheltered” exposure grading ³	all connectors ⁴	II
	• in areas of “moderate” or “severe” exposure grading ³		II
Exterior masonry above grade, in buildings greater than 11 m in height ²	• in areas of “sheltered” exposure grading ³	all connectors ⁴	II
	• in areas of “moderate” or “severe” exposure grading ³	anchors ⁴	II
	• in areas of “moderate” or “severe” exposure grading ³	all connectors except anchors ⁵	III

Source: Reproduced from CSA A370-94, Table 2

Notes:

- 1) Connectors in more aggressive environments should be given special consideration and should be provided with adequate corrosion protection for the conditions to which they will be subjected. (An example of a more aggressive environment might be a storage facility for chemicals that could react with the connector or masonry immersed in water.)
- 2) Building height is measured from the floor level of the first storey.
- 3) The exposure gradings of sheltered, moderate and severe weathering are outlined in Figure 2.17, (p. 2-57), Annual Rain Index.
- 4) All elements of anchors for stone that are engaged in the stone or are in direct contact with stone that is easily stained or may react adversely with any material coatings of the anchor, shall have Level III corrosion protection. All other elements of stone anchors, including those elements that are fully embedded in mortar and not engaged in the stone, may have Level II corrosion protection.
- 5) Ties and their fasteners for stone masonry are often referred to as stone anchors and shall have Level III corrosion protection.

Table 2.13: Maximum Spacings for Conventional and Non-conventional Ties

Type	Maximum spacing in mm (in.)		Remarks
	Horizontal	Vertical	
Continuous welded ladder/truss reinforcing/tie	Cavity of 125 (5): vertical 600 (24) Cavity of 150 (6): vertical 400 (16) Stack bond or overlap of units <50 (2): vertical 400 (16)		Minimum wire diameter: 3.65 ± 0.15 mm (Wire diameter of 4.76 mm (0.19 in.) is sometimes used in earthquake design.) Cross wire spacing 400 mm (16 in.)
Rectangular wire ties	800 (32) 600 (24)	400 (16) 600 (24)	Maximum cavity width: 150 mm (6 in.) Wire diameter: 3.65 ± 0.15 mm (0.14 ± 0.005 in.) Minimum tie width: 100 mm (4 in.)
Dovetail anchors/ties	800 (32) 600 (24)	400 (16) 600 (24)	Maximum cavity width: 40 mm (1.5 in.) Thickness: 1.52 ± 0.15 mm (0.06 ± 0.005 in.) Width: 25 ± 2 mm (2 in. ± 0.08 in.)
Z-wire ties	800 (32) 600 (24)	400 (16) 600 (24)	Maximum cavity width: 150 mm (6 in.) Wire diameter: 4.76 ± 0.15 mm (0.19 ± 0.005 in.) Minimum hook length: 50 mm (2 in.)
Corrugated strip ties	400 (16) 600 (24)	600 (24) 400 (16)	Maximum cavity width: 25 mm (2 in.) Not permitted above 11 m (36 ft.) height <i>Not recommended for type of construction in this guide.</i>
Corrugated dovetail anchor/ties	725 (28) 475 (18.7)	400 (16) 600 (24)	Maximum cavity width: 40 mm (1.5 in.) Thickness: 1.52 ± 0.15 mm (0.06 ± 0.005 in.) Width: 25 ± 2 mm (2 ± 0.08 in.)
Non-conventional	800 (32)	600 (24)	Except where permitted by CSA Standard S304.1
<p>Notes: Unless determined by engineering analysis, the above spacings must be suitably reduced for any of the following conditions:</p> <ul style="list-style-type: none"> • exterior walls more than 20 m (65.6 ft.) above grade • exterior walls located where 1 in 30 year references velocity wind pressure q exceeds 0.5 kn/m² (10.5 psf) (Reference Part 4 of <i>National Building Code of Canada</i>) • where ties are subject to lateral soil pressure • members or elements where loads other than wind cause additional forces 			

Table 2.14: Maximum Permissible Spacing at Openings for Ties

Location	Spacing
Around openings	600 mm (24 in.)
From the edge of opening	300 mm (12 in.)

Table 2.15: Maximum Permissible Spacing at Top and Bottom of Walls

Location	Spacing
From top or unsupported edge	300 mm (12 in.)
Where bearing support does not provide adequate lateral resistance, e.g., throughwall flashing on shelf angle	400 mm (16 in.)
Note: Refer to Figure 2.7, p. 2-21	

VERTICAL AND HORIZONTAL MASONRY REINFORCEMENT

Reinforcement performs the following functions:

- Horizontal joint reinforcement acts as ties, to control cracking, and acts as reinforcement to resist wind and earthquake forces.
- Vertical reinforcement resists lateral loads from winds and earthquakes and/or reinforces the masonry to help support vertical loads.

Vertical reinforcement is placed in the hollow cores of the block. The space is then filled with grout in lifts of 1200 mm (48 in.). The grout is consolidated by puddling or vibration. H-blocks will be required above a certain height to place blocks around the projecting rebar. The projection of rebar above the construction joint should be enough to lap the next lift of rebar to conform to the requirements of the structural engineer. The top course of block just below the structure is difficult to fill. This is done by using dry pack grout to fill the core.

INSULATION

The selection of the amount and type of thermal insulation is governed by occupant comfort, the prevention of condensation, energy conservation and cost. The computer program EMPTIED, which can be obtained from CMHC, can be helpful in determining insulation requirements. The following sections describe some commonly used insulation types and their properties. Installing insulation properly is critical to the thermal performance of the wall, and the designer should also heed the manufacturer's cautions as to temperature during installation and cleaning of substrate when adhesives are used. Explanation of some building concepts relating to thermal insulation can be found in Chapter 3.

Rigid and semi-rigid insulations of various materials are appropriate for use in masonry cavity-wall construction. An important material property to consider in selection of an insulation is how it reacts in the presence of moisture and what effect moisture will have on the thermal performance of the insulation.

Some types of insulations lose thermal resistance over time. This phenomenon is known as thermal drift. Thermal drift is caused by a chemical solubility between an insulation's blowing agent and polymer resin, or by air ingress into the insulation's cell structure.

Long-term weighted-average thermal resistance values must be obtained from the manufacturers. Approximate values are noted below.

Readers should refer to the ASHRAE/IES 90.1 Energy Standard and the *National Energy Code for Buildings* for guidance on this subject.

EXTRUDED POLYSTYRENE TYPE III AND IV

Extruded polystyrene insulation is a rigid product made of closed cell polystyrene foam and manufactured by an extrusion process. The applicable standard is CAN/CGSB 51.20-M87. Its physical properties and characteristics are listed below:

- dimensionally stable
- high thermal resistance
- low water vapour permeability
- high compressive strength
- very low water absorption and resists water penetration
- will not sustain mould growth
- lightweight
- no food value for rodents or vermin
- maintains insulation characteristics over time and extreme weather conditions
- combustible (flame spread rating greater than 25)
- deteriorates when exposed to direct sunlight

Extruded polystyrene insulations are compatible with adhesives meeting CGSB 71-GP-24M and the air/vapour barrier type adhesives.

Approximate thermal resistance per 25 mm (per inch) of thickness:

RSI = 0.88 (R = 5)

Vapour permeance: 23–92 ng/Pa•m²•s (0.4–1.6 perms)

EXPANDED POLYSTYRENE

Expanded polystyrene insulation is manufactured from expandable polystyrene beads containing a blowing agent and a flame-retardant additive. Steam heat expands the blowing agent to produce moisture-resistant, multi-cellular particles or pre-expanded beads. During the process, the beads expand up to 40 times their volume.

After an interim period during which the pre-expanded beads lose their moisture, the blowing agent condenses out and air diffuses into the cellular structure. After the air within the cells is stabilized, the pre-expanded beads are thermally fused (with steam) into blocks that are cured, then cut into slabs, sheets or other shapes. It can be moulded in a range of densities to yield the required compressive strength.

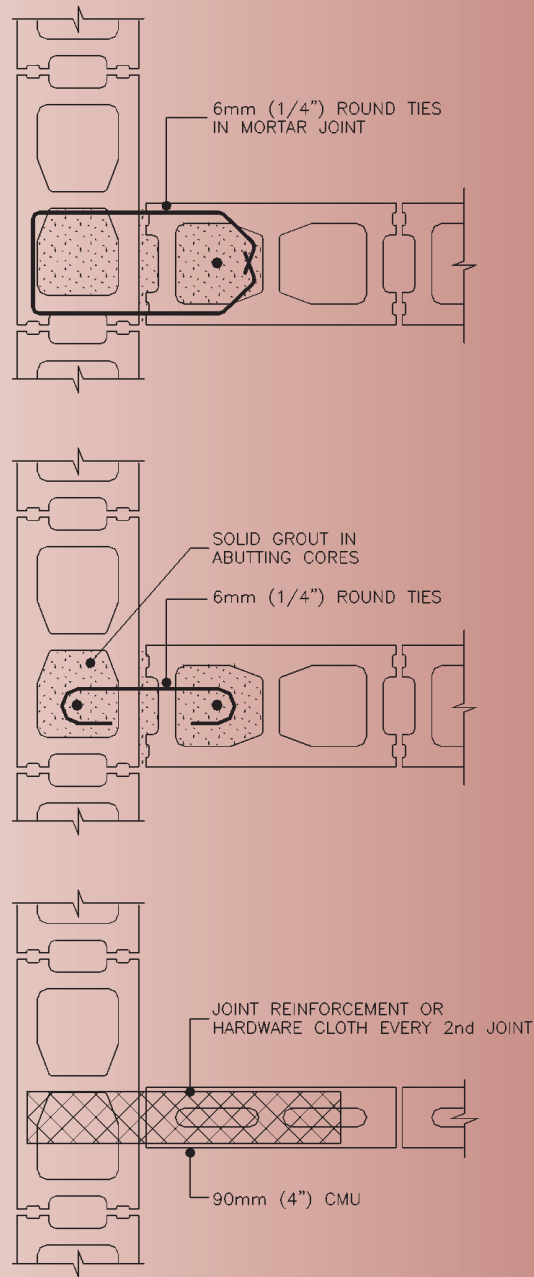

Figure 2.15: Anchorage of Intersecting Walls (Type 3)

Its properties are as follows:

- high thermal performance
- lasting insulation value
- withstands freeze–thaw without loss of structural integrity or physical properties
- resistant to moisture penetration
- low water vapour transmission
- ‘breathable’, that is, doesn’t trap moisture
- when wet, its R-value is only marginally affected
- combustible
- available with flame spread rating less than 25
- subject to ultraviolet degradation
- resilient
- easy to install
- lightweight
- inert, organic material – no nutritive value to plants, animals, or micro-organisms
- will not rot
- resists mildew
- deteriorates in contact with petroleum-based solvents or their vapours

Expanded polystyrene insulations are compatible with adhesives meeting CGSB 71-GP-24M and the air/vapour barrier type adhesives.

Approximate thermal resistance per 25 mm (per inch) of thickness:

RSI = 0.63 (R = 3.6)

Vapour permeance: 115–333 ng/Pa•m²•s (2–5.75 perms)

ISOCYANURATE

Isocyanurate insulation meeting CGSB 51.26-M86 is a rigid glass fibre reinforced polyisocyanurate foam core product with a uniform, closed-cell structure. It should be used with foil facing on both sides to resist moisture. Its physical properties and characteristics are as follows:

- very high R-value per unit thickness
- dimensionally stable
- foil facing acts as moisture barrier that is resistant to water vapour diffusion and water absorption
- foil facing acts as an air barrier when joints are sealed with tape or adhesive
- foil facing provides a radiant heat shield in air conditioned buildings
- with foil facing, the flame spread rating is less than 25
- lightweight

Isocyanurate insulation with foil facing is compatible with synthetic-rubber-based adhesives, as well as the air/vapour-barrier-type adhesives.

Approximate thermal resistance per 25 mm (per inch) of thickness:

RSI = 1.3 (R = 7.6)

Vapour permeance: < 60 ng/Pa•m²•s (1 perm)

MINERAL WOOL

Semi-rigid mineral wool insulation meeting CGSB 51.10-92 is made of volcanic rock and recycled steel slag that is melted and spun into rock fibres. A binding agent and water repellent film are added before it is cured in ovens that transform the binder into bakelite. Properties of semi-rigid mineral wool insulation are listed below:

- chemically inert
- lightweight (1–6% fibres, the balance of the material is air)
- porous – allows vapour diffusion
- water repellent – absorbs water when it is pressed or forced into the material; when pressure is relieved, the water evaporates and the material's original R-value is restored
- no capillary suction
- non-combustible and highly resistant to fire (flame spread rating less than 25)
- compatible with most building materials – will not promote corrosion
- non-directional structure gives it rigidity
- recovers to its full dimension after compression (good transverse elasticity)
- sound absorbing and impedes sound transmission
- does not encourage growth of fungi, mould or bacteria
- will not rot
- will not sustain vermin

Mineral wool insulation is compatible with all insulation adhesives.

Approximate thermal resistance per 25 mm (per inch) of thickness:

RSI = 0.75 (R = 4.2)

Vapour permeance: > 1500 ng/Pa•m²•s (26 perms)

GLASS FIBRE

Semi-rigid glass fibre insulation is a fine-fibred, shot-free product. Boards are formed to a predetermined, controlled density and thickness and bonded by a thermosetting resin for rigidity. Although the product is available with a vapour barrier facing, unfaced board is recommended for installation in masonry cavity-wall construction over adhered air/vapour barrier membranes. The material meets the requirements of CGSB 51-GP-10M. Its properties are as follows:

- dimensionally stable
- damage-resistant – maintains structural integrity and thickness
- non-combustible (flame spread rating less than 25)
- will not rot
- lightweight
- moisture-resistant
- odourless
- low moisture absorption
- does not cause or accelerate corrosion of steel, aluminum or copper
- does not breed or promote growth of fungi, mould or bacteria
- varying humidity and temperature conditions will not cause spalling or crumbling
- sound-absorbing and impedes sound transmission

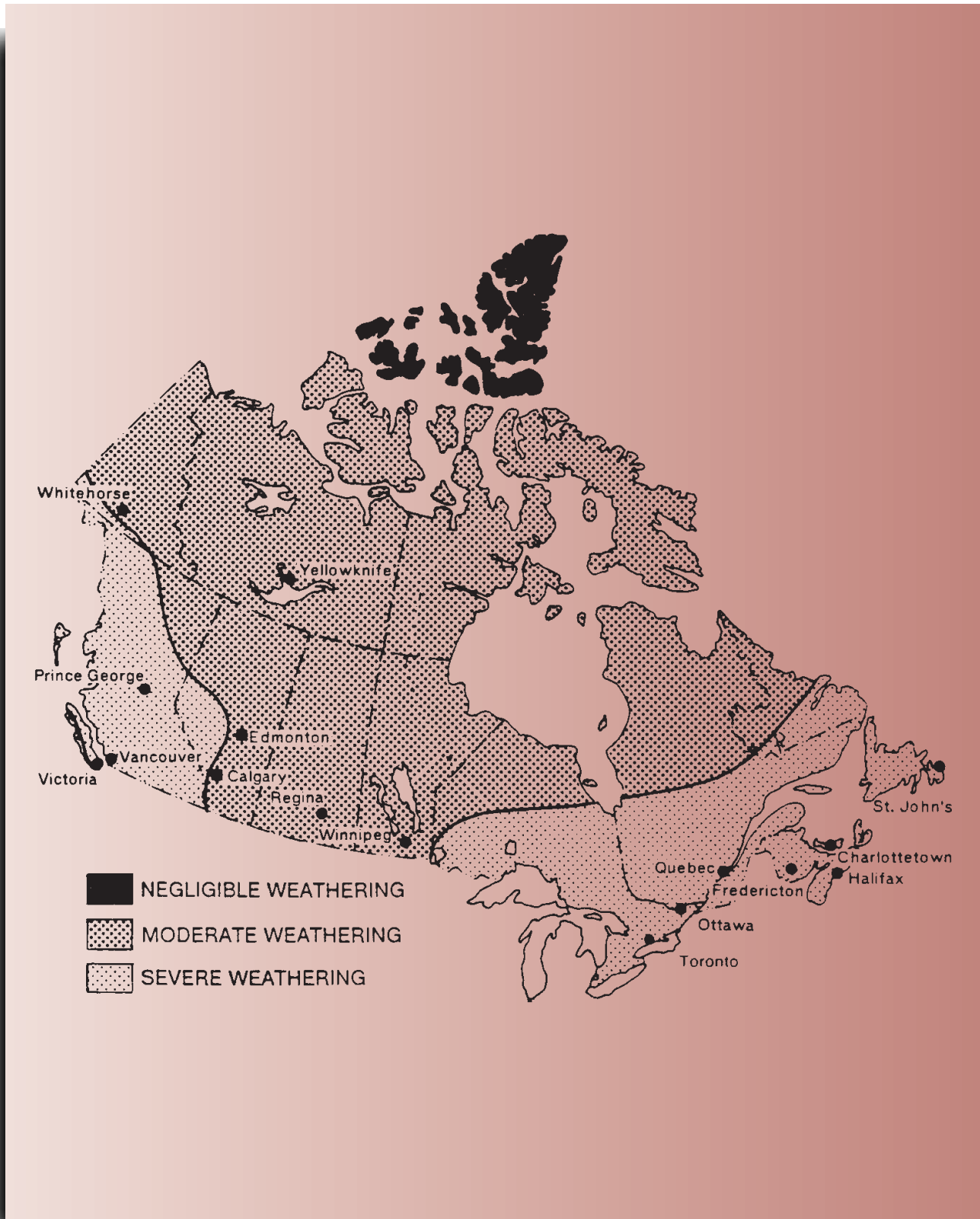

Figure 2.16: Weathering Index Map of Canada

Semi-rigid glass fibre insulation is compatible with all insulation adhesives.

Approximate thermal resistance per 25 mm (per inch) of thickness:

RSI = 0.76 (R = 4.2)

Vapour permeance: > 1500 ng/Pa•m²•s (26 perms)

AIR BARRIER AND VAPOUR BARRIER

This section describes some of the principal types and characteristics of sheet seal material used with masonry walls. Not all types of walls use a membrane that combines the functions of both an air barrier and a vapour barrier (or retarder). However, in a masonry wall that employs an elastomeric membrane, such as that illustrated in this guide, the designer must ensure that the membrane is placed on the warm side of the insulation, because of its vapour barrier function. Since this membrane also acts as an air barrier, it must be continuous with other elements that are part of the wall's air barrier function. That is, the membrane must be sealed to slabs, windows, doors and other penetrations. (Furthermore, windows and doors that are grouped together must also have a properly designed connection that prevents air leakage between them.) For more information, refer to Chapter 3, Building Science Concepts.

Sheet seal membranes that are either self-adhesive or thermofusible are recommended for use in masonry cavity-wall construction. Thermofusible-type membranes have no restriction on their application temperatures. There are restrictions on the application temperatures of self-adhesive membranes; these should be applied between -5°C and 40°C. Manufacturers must be consulted for specific restrictions.

THERMOFUSIBLE MODIFIED BITUMEN

Membranes designed to be fused to their substrates by heating the underside with a propane torch are SBS modified bitumen membranes reinforced with non-woven polyester or fibreglass. One or both sides may be torchable, depending on the manufacturer. Their properties are as follows:

- flexible at low temperatures
- no restriction in application temperature
- lightweight
- superior permanent adhesion to concrete, concrete block, primed steel, aluminum mill finish, anodized aluminum, galvanized metal, drywall and plywood
- impermeable to air, moisture vapour and water (air permeance: < 0.007 l/m²•s at 75 Pa (0.01 in.³/s•ft.²); water vapour permeance: 0.2 ng/Pa•m²•s (0.0035 perms))
- good elasticity, elongation and tensile strength, enabling the material to withstand dimensional changes and forces caused by building movements, and to bridge cracks and openings in the substrate material
- compatible with insulation adhesives and liquid seal air barriers
- self-sealing when penetrated with fastening elements for insulation, anchors and connectors
- non-resistant to oils and solvents
- surface film may release on extended exposure to ultraviolet radiation

SELF-ADHESIVE MODIFIED BITUMEN

One type of self-adhesive air barrier membrane is an SBS modified bitumen membrane reinforced with a proprietary glass scrim. It is available in various thicknesses, depending on the manufacturer. Its properties are listed below:

- flexible at low temperatures
- good adhesion to prepared substrates of concrete, concrete block, primed steel, aluminum mill finish, anodized aluminum, galvanized metal, drywall and plywood
- impermeable to air, moisture vapour and water (air permeance: $< 0.007 \text{ l/m}^2\cdot\text{s}$ at 75 Pa ($0.01 \text{ in.}^3/\text{s}\cdot\text{ft.}^2$); water vapour permeance: $0.2 \text{ ng/Pa}\cdot\text{m}^2\cdot\text{s}$ (0.0035 perms))
- good elasticity, elongation and tensile strength, enabling the material to withstand dimensional changes and forces caused by building movements, and to bridge cracks and openings in the substrate material
- compatible with insulation adhesives and liquid seal air barriers
- controlled thickness
- self-sealing when penetrated with self-tapping screws
- non-resistant to oils and solvents
- surface film may release on extended exposure to ultraviolet radiation
- easy to apply

SELF-ADHESIVE RUBBERIZED ASPHALT

Self-adhesive rubberized asphalt air barrier membranes are composite sheets of rubberized asphalt integrally bonded to a film of high-density cross-laminated polyethylene. Their properties are as follows:

- flexible at low temperatures
- impermeable to air, moisture vapour and water (air permeance $< 0.007 \text{ l/m}^2\cdot\text{s}$ at 75 Pa ($0.01 \text{ in.}^3/\text{s}\cdot\text{ft.}^2$); water vapour permeance $2.9 \text{ ng/Pa}\cdot\text{m}^2\cdot\text{s}$ (0.05 perms))
- puncture-resistant
- self-sealing when penetrated with self-tapping screws
- controlled thickness
- easy to apply
- requires protection from ultraviolet radiation
- good adhesion to most construction materials including concrete, concrete block, metal and wood gypsum sheathing
- surface conditioner required
- good elasticity, elongation and tensile strength, enabling the material to withstand dimensional changes and forces caused by building movements, and to bridge cracks and openings in the substrate material

FLASHINGS

Metal and flexible flashings of various materials are appropriate for masonry cavity-wall construction. Important factors to consider in flashing selection are compatibility with adjacent materials, ease of installation, durability, how waterproof the joints can be made if necessary, how well terminations at end dams and drip edges can be formed, and whether the material must be capable of movement.



Figure 2.17: Annual Rain Index

Flashings recommended for cavity walls are any of the following materials:

- prefinished galvanized steel
- stainless steel
- reinforced modified bitumen, either self-adhering, torchable or to be used with an adhesive
- self-adhering rubberized asphalt
- copper

For more information on flashings, refer to CMHC's Best Practice Guide – Flashings.

SEALANTS

SEALANT JOINTS

Sealants can be:

- elastic materials placed in a joint to block the passage of water and/or air while allowing movement between two sides of the joint; or
- mastic materials that are injected into the joint and then cured to a rubber-like state.

A sealant seals by adhering tightly to the substrate. A sealant installed in the joint must be able to expand and contract to accommodate the joint movement without cracking (cohesive failure) or breaking away from the substrate (adhesive failure). The maximum extension of a sealant is required on a cold day, when the adjoining panels experience the maximum contraction at exactly the time when flexible materials have the least capacity to expand.

Selection of sealant material should be based on the following criteria:

- water resistance
- UV resistance
- surface adhesion
- movement capability as tested in accordance with CAN/CGSB-19.0M or ASTM C719
- life expectancy
- exterior service temperature limits
- cladding material
- surface preparation
- compatibility with adjacent materials
- application temperatures
- curing time

These criteria must be compared with data supplied by the manufacturer to select the proper sealant.

GUIDELINES FOR SEALANT INSTALLATION

Proper Joint Design

- The width of a sealant joint should be determined based on the expected movement of adjoining cladding panels and the movement capability of the sealant. If the movement capability of the sealant is $\pm 25\%$ and the expected movement is 6 mm (0.25 in.), the width of the sealant joint should be 6 divided by 0.25 (that is, 25%) = 24 mm (0.95 in.). Chapter 3 provides a detailed analysis.
- Generally, sealant joints should not be narrower than 6 mm (0.25 in.). A joint narrower than this is difficult to make and has little ability to withstand movement. Joints can be as wide as 25–50 mm (1–2 in.), depending on the ability of the sealant not to sag out of the joint before it has cured.
- The depth of sealant in a joint should be equal to half the width of the joint, but not less than 6 mm (0.25 in.) or more than 13 mm (0.5 in.). If the joint is too deep, too much force will be required to produce the desired extension and the sealant may break away from the sides. If it is not deep enough, the material will tear apart (cohesive failure).

<i>Width</i>	<i>Depth</i>
mm (in.)	mm (in.)
6 (0.25)	6 (0.25)
20 (0.75)	10 (0.40)
32 (1.25)	13 max (0.5 max)

- The sealant must only be bonded to the surfaces on two opposite sides to allow it to expand and contract. A foam plastic backer rod or a tape must be used to act as a bond-breaker in the middle part of the sealant. A backer rod limits the depth of the sealant to a predetermined dimension, provides a firm surface against which to tool the sealant, and imparts to the sealant bead the narrow waist shape that helps minimize stresses. Refer to [Figure 2.10](#), (p. 2-26).

Proper Material Specification

- Sealant selection should be based on its elastic properties, in the following categories:
 - low performance (e.g., oil-based and acrylic latex): movement capability 5% and service life 2–5 years
 - medium performance (e.g., butyl and solvent release acrylic latex): movement capability 12.5% and service life 8–10 years
 - high performance (e.g., elastomeric sealants: polysulphides, urethanes and silicones): movement capability 25–50% and service life 10–15 years.
- Backer rod must be 30–50% larger than the joint's maximum width.
- For exterior envelope components, urethanes or silicones are used depending on the type of adjoining materials. Polysulphides have been reported to have durability problems in locations exposed to sunlight.

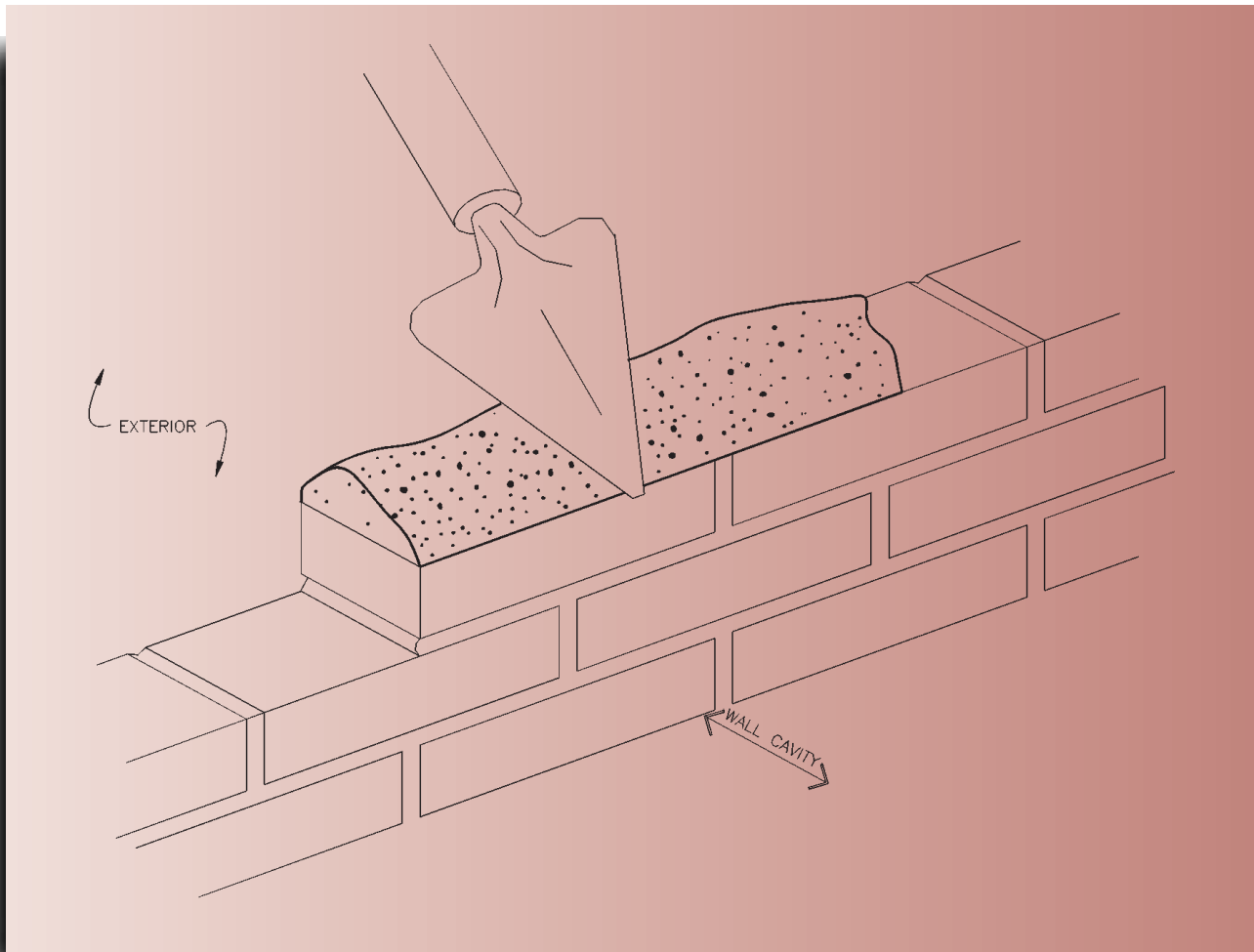

Figure 2.18: *Beveling the Inside Bed Joint*

Proper Installation

- Follow manufacturer's instructions.
- Clean substrate.
- Install proper size backer rod or tape.
- Apply in suitable weather. If possible, seal joints in spring and fall to avoid large temperature swings during curing. Large temperature swings during curing, i.e., warm days/cold nights, may cause adhesive failure. If this is not possible, select days with the minimum variation in day and night temperatures.
- Fill all segments of the joint.
- Perform joint tooling within the time recommended.
- Use tape to mask the adjoining surfaces for proper cleanup.

For design of movement joints, refer to Chapter 3.

CAVITY (OR AIR SPACE)

FUNCTION

In the modern brick veneer/CMU exterior wall system, a continuous space known as a cavity is maintained between the two masonry wythes. The cavity facilitates the incorporation of non-masonry components, such as insulation and an air/vapour barrier membrane, needed to effectively resist environmental loads imposed on the masonry wall system.

In a rain-screen wall, within the cavity, a continuous *air space* will be maintained between the inner surface of the exterior masonry wythe and the cavity insulation (which is secured to the outer surface of the concrete masonry backing). This air space serves a number of functions:

Environmental Requirements

1. It provides a pathway for any moisture that enters the cavity to drain to the outside of the system by means of weep holes (drainage openings) located at the base of the wall.
2. Along with an effective air barrier system and sufficient venting, the air space provides a chamber to effect pressure equalization or partial pressure equalization across the exterior masonry wythe to help counteract those forces that drive water through the envelope.
3. It provides a space to allow uncontrolled air leakage from the building to readily escape, and therefore serves to minimize the potential for condensation and the adverse effects of condensation on the wall system.
4. It helps dry the wall components by permitting air movement.
5. It serves as a barrier (capillary break) to help retard or prevent the passage of moisture through the wall assembly.

Structural Requirements

6. Where needed structurally, it accommodates differential movement between the wythes caused by moisture and temperature changes.

Construction Requirements

7. It accommodates construction tolerances between masonry-masonry and masonry-structural frames.

To perform the environmental functions effectively, the air space must be kept *reasonably* clear of mortar fins (which bridge the cavity), and from mortar droppings, to prevent mortar from providing a path to conduct water across the cavity, and to prevent mortar from blocking the drainage pathways and weep holes at the base of the wall. Indeed, the A371 Standard acknowledges that it is not possible to maintain a totally free air space clear of mortar fins and mortar droppings. Moreover, the application of an air/vapour barrier membrane to the exterior surface of the CMU backing, a design recommended by this document, provides protection against the ingress of moisture to interior space, and therefore alleviates somewhat the need to provide a completely clear air space. However, the weep holes at the wall base must never be obstructed.

The air space may be kept reasonably clear of mortar fins by bevelling the mortar beds to incline away from the cavity when laying the masonry units [Figure 2.18](#), (p. 2-60). This practice requires very little effort and is very effective in keeping mortar out of the drainage space. Placing wood strips

with attached wire pulls to be drawn upward during construction to clean the cavity is often demanded by project specifications, but it is seldom done on the job site. It is impractical because of the interference with its movement offered by the masonry wall ties, and because of variations in the constructed width of the air space resulting from construction tolerances.

A number of options are open to the mason and the designer to help keep the weep holes unobstructed, including: (a) the placement of a coarse gravel drainage layer in the air space at the wall base; (b) the placement of a wire screen in the air space one or two courses above the base flashings; or, (c) the use of proprietary mortar dropping control devices such as that shown in [Figure 2.11](#), (p. 2-34) or 2.12, (p. 2-38). When these methods are used, caution in both design and construction must be exercised. Without due care to minimize mortar droppings as the units are laid, these methods encourage the accumulation of mortar droppings higher up the wall, and where the design does not provide for a waterproof membrane to be applied to the backing and where flashing does not extend sufficiently high up the wall, or where the membrane has not been properly placed or sealed, these methods may facilitate the ingress of moisture to interior space. Leaving out masonry units at the wall base to enable clean-out adjacent to weep-hole locations, with subsequent placement of these closure units, will ensure that the path of water will not be obstructed.

MINIMUM AIR SPACE

The design width of the air space is that width shown on the construction drawings. When determining this width, the designer should take into careful consideration the function of the air space in the wall assembly with respect to the environmental, structural and construction requirements.

The A371 Standard now provides guidance to the designer for the selection of an appropriate minimum design width of air space. Where an air space is required by the design and the air space serves functions 1 through 5, it is recommended that a design width of not less than 25 mm (1 in.) be selected. Further, with respect to function 5, if the air space is relied on *as the principal means* for providing resistance to the ingress of moisture into interior space, a design width of not less than 40 mm (1.5 in.) should be specified. Thus, where a waterproof membrane is applied to the structural backing, it is reasonable to specify a 25 mm (1 in.) design air space since the air space does not serve as the principal means to prevent the ingress of precipitation, and where a waterproof membrane is not applied, a 40 mm (1.5 in.) design width would be more appropriate.

DESIGN WIDTH AND CONSTRUCTED WIDTH

In addition to environmental considerations, the selection of an appropriate design width must also consider construction tolerances: acknowledged and acceptable deviations of constructed building elements from specified plan, specified elevations and plumb. Because construction tolerances for the masonry and the structural backing are normally accommodated by the air space, *the width of the constructed air space will likely vary from the design width.*

Compatible and achievable construction tolerances for masonry elements are provided in CSA A371. Unfortunately, a review of applicable standards will show that construction tolerances for each building material in the construction industry have been developed independently of one another. The difficulty is that allowable tolerances for structural frames stated in their

respective construction standards are greater than acceptable tolerances for claddings such as masonry. This gives rise to interference fits, even where frame and claddings have been erected in accordance with the construction tolerances permitted by their applicable standard. Because this incompatibility has not been appropriately addressed to date by the construction industry, it is clear that the solution for the designer at this time is to:

- take advantage of the existence of an air space in brick veneer/CMU wall assemblies to accommodate the reasonably expected construction tolerances between masonry-masonry and masonry-structural frames; and
- provide design details that readily accommodate these anticipated dimensional variations.

To select an appropriate design width, the designer must integrate these recommendations for minimum design width of air space provided by CSA A371 with the reasonably foreseeable construction tolerances for the building under consideration, to arrive at a suitable, anticipated constructed width of air space. Among many other influencing factors, anticipated deviations across the air space are smaller for low-rise construction than for high-rise, and are smaller for all-masonry structures where the masonry contractor controls placement of both the CMU backing and the exterior masonry wythe.

It is the responsibility of the designer to determine the appropriate design width along with the permissible variation in the constructed width so that the wall system will perform satisfactorily throughout its design service life. These dimensions and tolerances should be communicated to the contractor in the construction documents. Where the designer has failed to specify permissible width variations, a default of ± 13 mm (± 0.5 in.) is used by the A371 Standard, and this value is consistent with the permissible placement tolerances for masonry wall ties (clauses 5.5 and 5.6 of A371).

Also in accordance with the A371 Standard, at any time during the course of construction it is the responsibility of the masonry contractor to notify the designer where the width of the constructed air space does not satisfy the specified permissible design width variations. This will enable the designer to effectively address the issue of tolerances and its impact on the design and performance of the wall system, and to correct this problem.

INTRODUCTION

This chapter discusses the principles of building science that have guided the selection and placement of the elements of the masonry cavity wall, illustrated by the CAD details in Chapter 4.

Building science applies the principles of physical science to the design of buildings. This chapter presents the following elements of building science, as it relates to brick facing and CMU backing exterior walls with a cavity:

- heat flow
- air flow
- water vapour flow
- rain penetration
- water and moisture control
- fire
- design of masonry for crack control
- structural design

HEAT FLOW

The largest component of total energy consumption for a building in Canada is in keeping the building warm during the heating season (fall, winter and spring).

Heat flow through the building envelope follows a basic principle of physics, that heat flows from matter of a higher temperature to that of a lower temperature. While heat flow cannot be prevented, it can be controlled or slowed down to decrease the total energy consumption of the building.

Heat transfer takes place through the following processes:

- conduction through the envelope materials
- convection within envelope surfaces and air spaces
- radiation across the envelope
- air leakage

The rate of heat transfer depends on the following:

- the difference between the interior and exterior temperatures
- the capacity of the envelope to control heat flow, for example:
 - thermal resistance of the envelope
 - air leakage control
 - convection spaces
 - radiant heat performance

The following measures are taken to control heat flow:

- a continuous thermal or insulation barrier is built within the wall and roof construction
- a continuous air barrier is provided in the walls and roof to prevent heat loss through air leakage
- convection spaces within the envelope are avoided

The insulation used on the exterior of the concrete block within the cavity is foamed-plastic rigid board or semi-rigid glass and mineral fibre board. The

thermal resistances of these materials range from approximately 0.68 to 1.35 RSI (calculated as $\text{m}^2 \cdot \text{°C}/\text{W}$) per 25 mm thickness (4–7.8 R, calculated as $\text{ft}^2 \cdot \text{h} \cdot \text{°F}/\text{Btu}$ per inch thickness). Space restrictions and total wall thicknesses typically dictate the insulation thicknesses used; insulation thicknesses of 75 to 100 mm (3 to 4 in.) are typical. The total thermal resistance of the wall assembly is the sum of the thermal resistances of all of the materials, including air spaces and air films.

Thermal bridges that cause heat loss result from heat flow by conduction through the following structural elements:

- masonry veneer ties
- structural penetrations such as balcony slabs
- shelf angles

The effects of thermal bridging caused by the above elements can be minimized as follows:

- reducing the cross-section area of metal crossing the cavity
- using stronger and fewer ties, within the maximum spacing limits of CSA A370-94
- reducing the contact area of the shelf angle of the structure by using brackets
- if possible, thermally breaking balcony structures

The thermal resistance of a typical wall assembly was calculated based on data and methods outlined in *ASHRAE Fundamentals* see [Table 3.1](#), (p. 3-3).

The parallel flow method, described in *ASHRAE Fundamentals*, can be used to calculate the approximate thermal resistance of the total wall assembly. The relative areas of the three sections listed is used to calculate the weighted thermal conductance of each section, and the total thermal conductance can be approximated by summing the weighted conductance. The approximate average resistance is then equal to the inverse of the total conductance.

As indicated, the total or average thermal resistance of the wall is 2.99 ($\text{m}^2 \cdot \text{°C}/\text{W}$). This is a 0.8% reduction in thermal resistance, compared with the insulated portion of the wall. While this typical wall construction does result in built-in thermal bridges, their effect on the overall performance of the wall is not significant.

However, the effect at the balconies is significant. By thermally isolating the balcony structure from the floor slab, it is estimated that significant savings in heating costs can be achieved, depending on the number of balconies and the location of the building.

In general, the design of the thermal envelope should incorporate the following elements:

- a continuous thermal barrier
- minimal thermal bridging
- minimal mass transport of heat through air leakage

Table 3.1: Wall Assembly Thermal Resistance (RSI)

	Insulation	Shelf angle	Masonry ties	Balcony concrete slab	Balcony steel rebar
Exterior surface (6.7 m/s wind)	0.030	0.030	0.030	0.030	0.030
Sealant along shelf angle	—	0.070	—	—	—
Mortar at tie	—	—	0.025	—	—
Brick veneer	0.142	0.142	0.142	—	—
50 mm air cavity	0.200	0.200	0.200	—	—
Fibre insulation 75 mm semi-rigid glass	2.040	—	—	—	—
Steel shelf angle	—	0.004	—	—	—
Masonry veneer tie	—	—	0.004	—	—
Air barrier membrane	0.026	—	—	—	—
200 mm concrete block	0.200	0.200	0.200	—	—
40 mm furring space	0.200	0.200	0.200	—	—
Gypsum wallboard	0.056	0.056	0.056	—	—
625 mm concrete	—	—	—	0.448	—
625 mm long rebar	—	—	—	—	0.014
Interior surface	0.120	0.120	0.120	0.120	0.120
Resistance R (m²•°C/W) (ft. ² •h•°F)/Btu	3.014 (17)	1.022 (5.8)	0.977 (5.5)	0.628 (3.5)	0.164 (0.92)
Conductance 1/R (W/(m ² •°C)) (Btu/ft. ² •h•°F)	0.332 (0.058)	0.978 (0.03)	1.024 (0.032)	1.59 (0.05)	6.10 (0.191)

Table 3.2: Calculation of Average Thermal Resistance

	Percentage of wall	Weighted conductance	Imperial conversion
Shelf angle (10 mm plate)	0.4	0.4(0.978)/100	0.4(0.03)/100
Veneer reinforcement	0.004	0.004(1.024)/100	0.004(0.032)/100
Insulation area	99.596	99.596(0.332)/100	99.596(0.058)/100
Sum of weighted conductance		0.335 W/(m ² •°C)	0.058 Btu/(ft. ² •°F)
Total resistance = 1/C		2.99 (m²•°C)/W	17.24 (ft.²•h•°F)/Btu

AIR FLOW

Awareness has been growing throughout the building industry of problems with air leakage through the building envelope. The concerns with air leakage are as follows:

- general energy efficiency
- deterioration of construction materials as a result of moisture from condensation
- interior comfort level
- mould and odours resulting from accumulation of moisture
- infiltration of exterior pollutants

Air leakage through openings in the building envelope is caused by the difference in air pressure between the interior and the exterior of the building. The difference in air pressure is caused by one or more of the following factors:

- stack effect
- wind
- mechanical ventilation pressurization

STACK EFFECT

The stack effect (or chimney effect) is the result of warmer air inside being lighter than the cooler air outside. Warm air rises, creating a slight outward pressure near the top of the building and a slight inward pressure at the base. Therefore, air tends to infiltrate at the lower levels of the building and exfiltrate at the upper levels.

WIND

Wind has the following effects:

- pressure on the windward side
- suction on the leeward side
- suction on the sides
- suction on the roof

Wind pressure and suction increase with height. Pressure causes infiltration of air, and suction causes exfiltration of air.

MECHANICAL VENTILATION PRESSURIZATION

Mechanical ventilation in a building is provided by fans. Fans are required either to exhaust air or to supply air to a building. If the supply is greater than the exhaust, the building is said to be pressurized with positive pressure, that is, air tends to be forced through the openings. If the supply of air is less than the exhaust, the building is said to be pressurized with negative pressure, that is, the air infiltrates through the openings in the envelope. Positive pressure is maintained in the building to counter the stack effect at the lobby level.

AIR BARRIER GUIDELINES

The cumulative effect of these factors can be positive or negative, depending on other factors. Figure 3.2 illustrates the differences in air pressure across the building envelope.

All materials in the building envelope that have resistance to air leakage will be affected by these differences in pressure.

For the whole air barrier system, a National Research Council publication, *An Air Barrier for the Building Envelope* (NRC 29943, 1989), provides the following guidelines for maximum air leakage rates for air barrier assemblies in different types of buildings (based on a pressure difference of 75 Pa (1.56 psf)):

- For buildings with low humidity (0- 27% RH), the suggested maximum air leakage rate is 0.15 L/s•m² (0.22 in.³/s•ft.²).
- For moderately humid buildings (25-55% RH), such as houses and office buildings, the suggested maximum air leakage rate is 0.10 L/s•m² (0.15 in.³/s•ft.²).
- For high-humidity buildings and building environments (more than 50% RH), such as art galleries, computer rooms, museums or hospitals, the suggested maximum air leakage rate is 0.05 L/s•m² (0.74 in.³/s•ft.²).

These maximum air leakage rates are the same as those in Table A-5.4.1.2 of the 1995 *National Building Code of Canada* (NBCC).

Leakage rates can be put in perspective by the following simple analysis.

Based on the leakage rate of 0.10 L/m²•s (0.15 in.³/(s•ft.²)) at an air pressure differential of 75 Pa (1.56 psf), a leakage area, sometimes referred to as an equivalent leakage area (ELA), can be calculated using the following formula:

$$\begin{aligned} \text{ELA} &= \frac{Q}{787.5(\Delta P)^{1/2}} \\ &= 0.147 \times 10^{-6} \text{ m}^2 (1.58 \times 10^{-6} \text{ ft.}^2) \end{aligned}$$

where ELA is leakage area in m²

Q is the flow rate in L/s

ΔP is the air pressure differential in Pa

This ELA for 1 m² (10.75 ft.²) of wall is equivalent to a 0.5 mm (0.0196 in.) crack only 29.3 mm (1.15 in.) long. Under these guidelines, only very small defects in air barrier application are acceptable.

To assess the energy side of the requirement for air leakage control, the heat loss calculated for an exterior temperature of -27°C (-17°F) and an interior temperature of 20°C (68°F) for a 1 m² area of the wall presented in this chapter, under “Heat Flow,” is approximately 15.7 W (4.9 Btu/ft.²). Based on the air leakage rate of 0.1 L/m²•s (0.15 in.³/s•ft.²) at 75 Pa (1.56 psf), the heat loss at this flow rate and pressure differential is 5.7 W/m² (1.8 Btu/ft.²) of wall, or 27% of total heat loss.

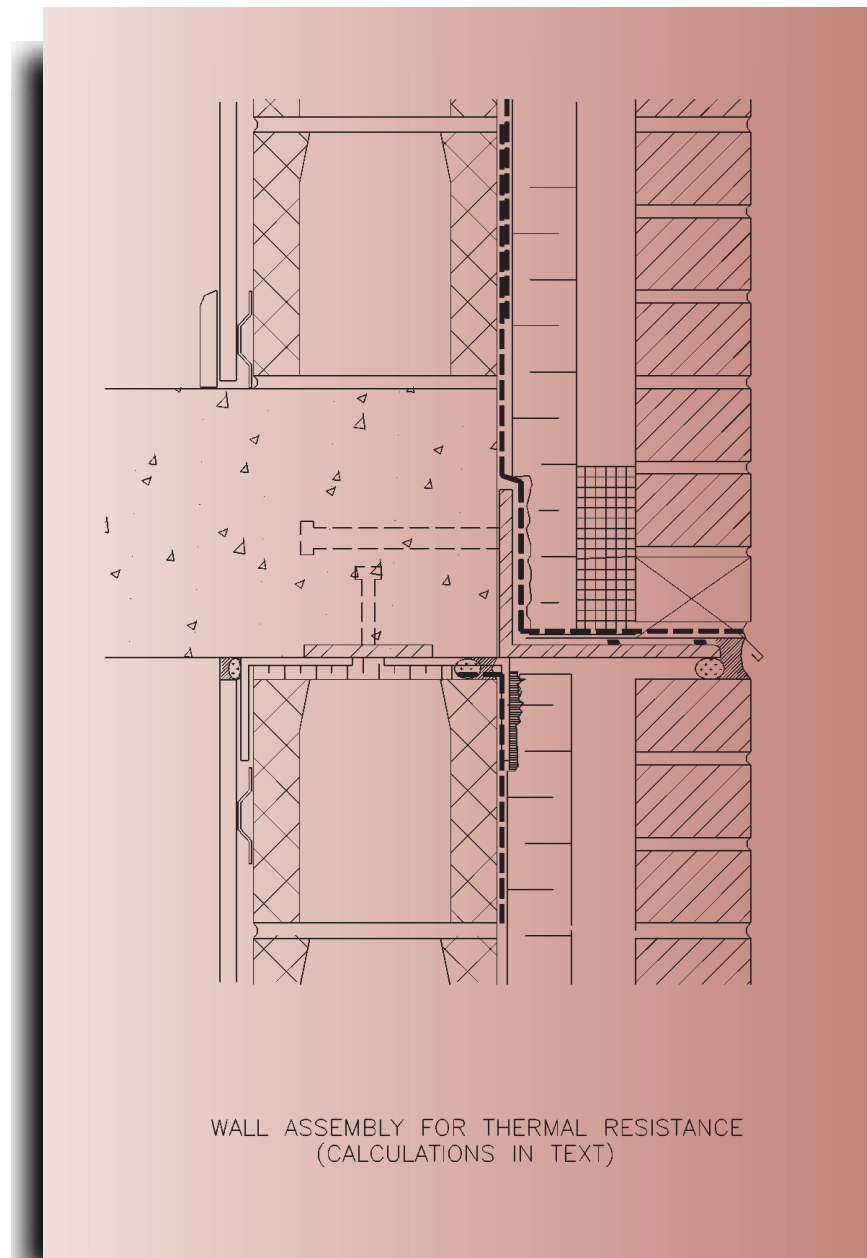

Figure 3.1: Thermal Resistance

Based on a survey of envelope consultants, air leakage rates 10–100 times the recommended rate are common in existing high-rise apartments, as found in CMHC’s field survey of 10 high-rise buildings across the country (*Field Investigation of Air Tightness, Air Movement and Indoor Air Quality in Highrise Apartment Buildings: Summary Report 1993*).

Although the energy use and comfort level of the building enclosure are of concern, likely the biggest problem in building envelope construction is deterioration resulting from moisture accumulation in the enclosure assembly, as a result of deficiencies in the air barrier system that allow exfiltration of warm moisture-laden interior air.

While concrete block and concrete and clay brick assemblies are extremely resistant to deterioration by moisture, large, uncontrolled volumes of moisture entering the air space in masonry veneer/CMU construction may cause premature deterioration of the metal components, reduce the thermal resistance of cavity insulations, produce efflorescence and, in extreme cases, cause spalling of units or displacement of veneer panels. Distress tends to be localized and usually occurs near the source of the air leakage.

Air leakage through the air barrier assembly can also disable the beneficial effects of a pressure-equalized rain screen. This is discussed in more detail in “Rain Penetration.”

As presented in the National Research Council *Building Practice Note* (BPN) 54, under a pressure differential of 10 Pa (0.21 psf) (equivalent to a 15 km/h (10 mph) wind), 2600 m³ (91 818 ft.³) of air will flow through a 625 mm² (1 in.²) opening in the air barrier of a wall in a one-month period. With the exterior at -20°C (-4°F) and 80% RH and the interior at 20°C (68°F) and 30% RH, the amount of water passing through the opening in the form of vapour will be 14 kg (31 lb.). Assuming only 10% of the water vapour condenses within the wall assembly, 1.4 kg (3.1 lb.) of water or frost will be deposited within the wall over one month.

Because of potential problems with air leakage through a building envelope separating conditioned space from the exterior, Part 5 of the NBCC provides largely performance requirements, with the following objectives:

- to assess a building’s need for an air barrier system
- to define the properties of the air barrier system

Many materials have characteristics to effectively stop air flow. However, the challenge is to detail and install the materials to make joints and junctions with other materials effectively control the air flow.

BPN 54 gives air barrier design requirements for the materials and method of assembly to build an air barrier system to adequately control air leakage.

These design requirements are summarized as follows:

- The air barrier assembly must be continuous throughout the building envelope.
- The air barrier assembly must be structurally adequate to resist air pressure from peak wind loads, sustained stack effect or fan pressurization from ventilation equipment.
- The air barrier assembly must be sufficiently rigid to resist displacement.
- The total air barrier assembly must be virtually air impermeable. (Maximum recommended air leakage rates have already been discussed.)
- The air barrier assembly must be durable, with materials with long service life expectancies and (or) materials positioned to be easily serviced.

WATER VAPOUR FLOW

The primary function of a vapour barrier or retarder is to inhibit the movement of moisture as it diffuses through the building envelope. Diffusion is the movement of water vapour through a material from a location of high vapour concentration to one of lower concentration.

The vapour diffusion rate depends on the difference in vapour pressure across the assembly and how well the materials in the assembly resist vapour diffusion.

The difference in vapour pressure across the assembly is a function of the temperature and relative humidity of the air on each side. Of particular concern in cold climates is the vapour pressure differential across the assembly during winter, when water vapour pressure drives vapour from the moist, warm interior to the cold, dry exterior. This may become a problem where large amounts of moisture can accumulate within the assembly, or where periods of drying are not offered, particularly if the materials and components used in the assembly have no resistance to the mechanisms of deterioration from moisture.

Construction materials have a moisture diffusion resistance measured by their water vapour permeance. The maximum water vapour permeance of a type I vapour barrier, defined in CAN 2-51.33, is $15 \text{ ng}/(\text{Pa}\cdot\text{s}\cdot\text{m}^2)$ (0.26 perms). This permeance can be handled by a broad range of materials, including polyethylene sheet, foil, metal, glass, vapour retarder paints and most materials in air barrier membranes.

The case study presented in the “Air Flow” section of BPN 54 contains a calculation of the total water movement through a wall assembly with a permeance of $5 \text{ ng}/(\text{Pa}\cdot\text{s}\cdot\text{m}^2)$ (0.086 perms). Under the exterior temperature of -20°C (-4°F) and 80% RH and interior temperature of 21°C (68°F) and 30% RH, approximately 6 g (0.21 oz.) of water will diffuse through the wall cavity in one month. The water accumulation resulting from air leakage conditions was 233 times greater than the water vapour resulting from diffusion.

Based on the amount of moisture diffusion calculated in BPN 54, it would appear that the vapour barrier is an unimportant component of the wall assembly. However, the vapour barrier should not be omitted. It is particularly important for buildings with potentially high vapour pressure differentials, for example, in high-humidity buildings and building environments, such as swimming pools, hospitals and museums, and in residential buildings with occupants requiring a higher-than-average relative humidity.

To control water vapour diffusion, the vapour barrier must be installed on or near the warm side of the insulation material, which is normally on the side of the assembly with the higher vapour pressure. In masonry brick veneer/CMU construction, the elastomeric air barrier materials installed on the warm side of the insulation along the exterior face of the concrete masonry backing also provide adequate vapour diffusion control. In this case, they provide both an air barrier and a vapour barrier.

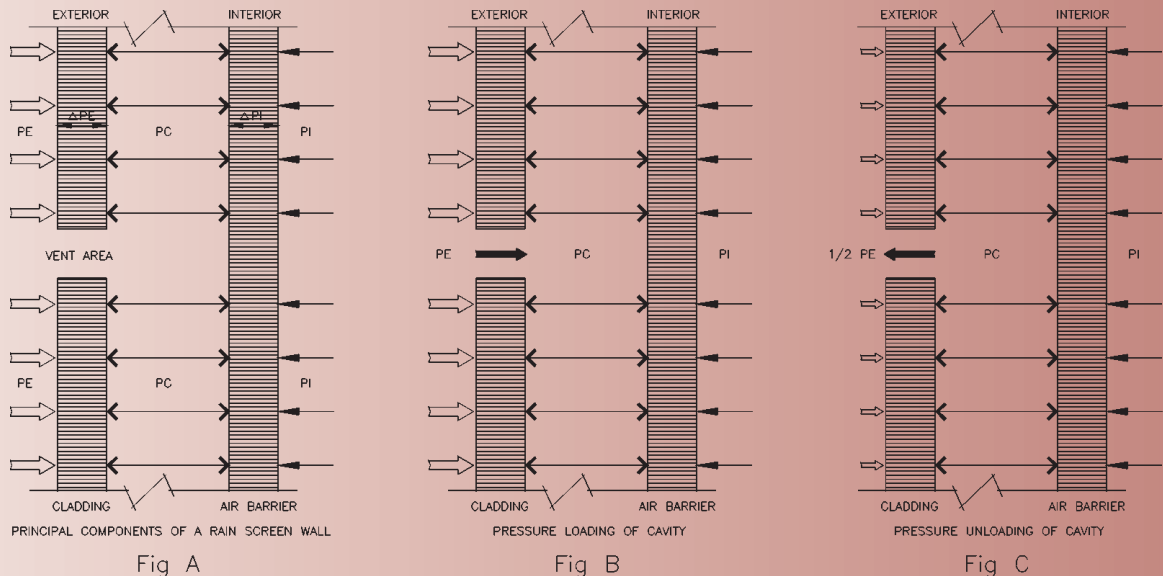

Fig. A UNDER AN APPLIED WIND PRESSURE (P_E), AIR FLOWS INTO THE CAVITY CAUSING THE CAVITY PRESSURE (P_C) TO INCREASE UNTIL $P_C=P_E$, AND $\Delta P_E=0$. WHEN THE ENTIRE WIND PRESSURE IS FELT BY THE AIR BARRIER, ($\Delta P_I=P_C-P_I$), PRESSURE EQUALIZATION HAS OCCURRED.

Fig. B IN CONDITION (b), WHEN PRESSURE EQUALIZATION OCCURS, $P_E=P_C$ AND THERE IS NO DRIVING FORCE TO CAUSE WATER TO PENETRATE THE CLADDING.

Fig. C WHEN THE EXTERIOR LOAD DECREASES, $P_C > P_E$ UNTIL PRESSURE EQUALIZATION OCCURS, THEREFORE THERE IS A NET NEGATIVE LOAD ON THE CLADDING, CAUSING OUTWARD AIR MOVEMENT.

PRESSURE EQUALIZED RAIN SCREEN (PER) CONCEPT

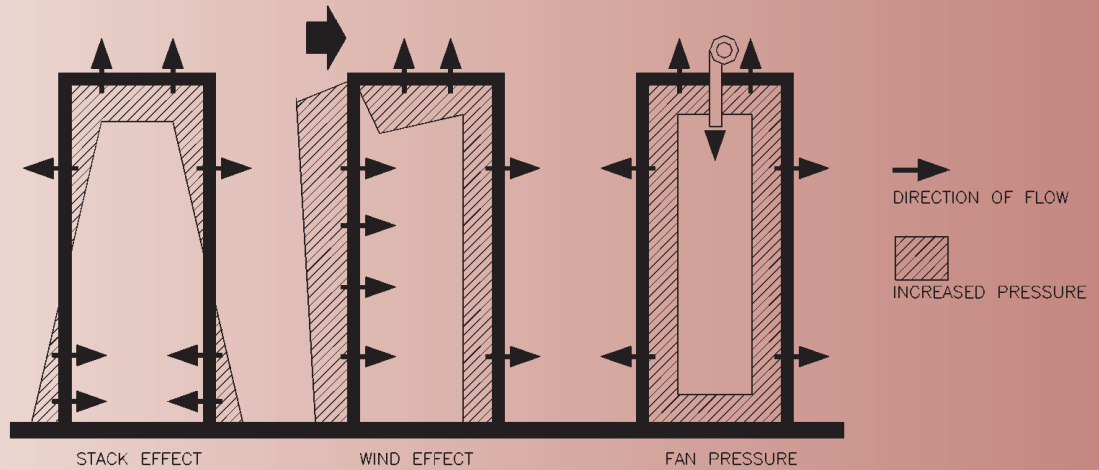

Figure 3.2: Rain and Air Pressure

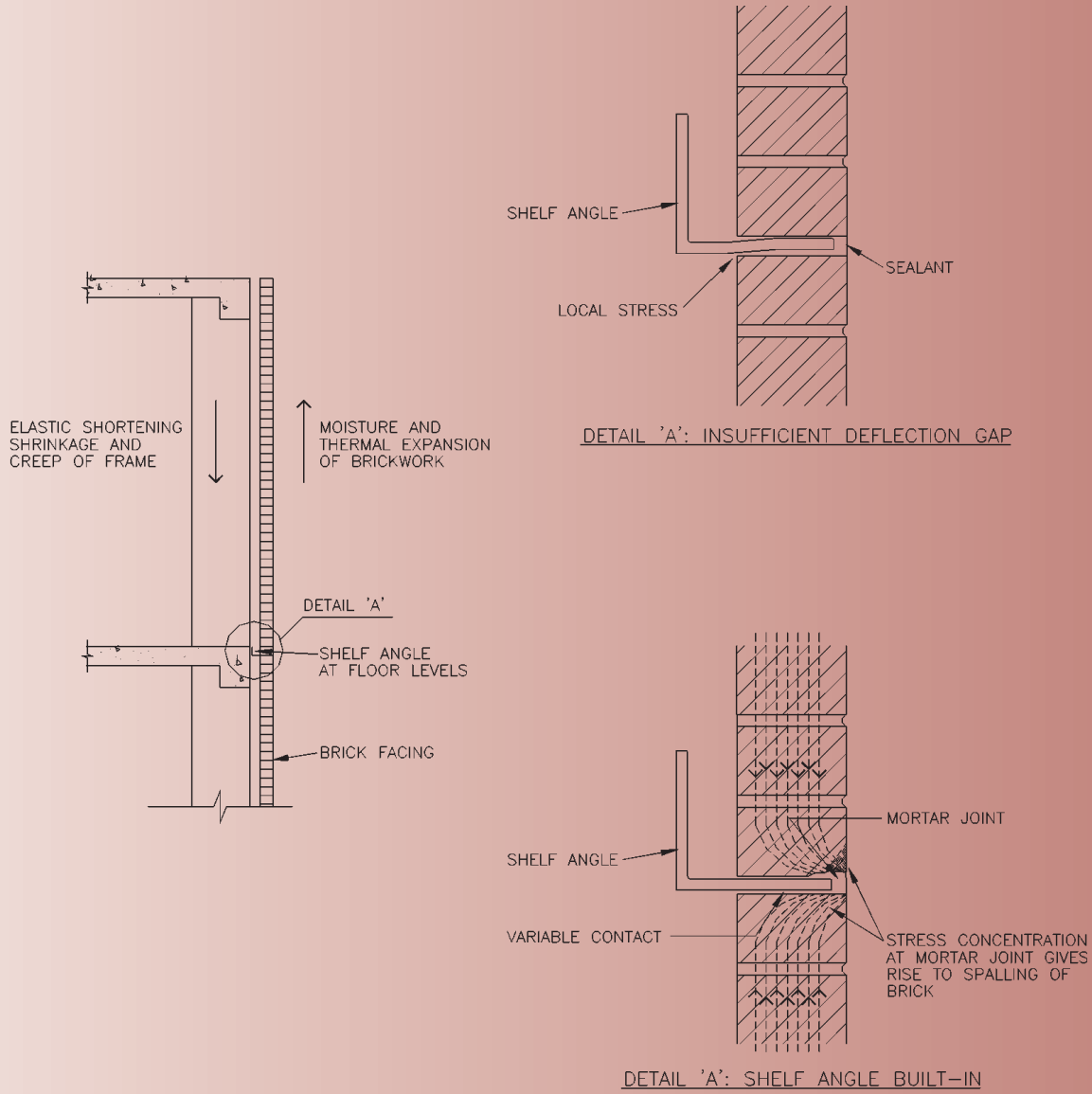

Figure 3.3: Brick Distress Caused by Insufficient Gap Below Shelf Angle

Part 5 of the NBCC provides largely performance requirements, with the following objectives:

- to assess a building's need for a vapour barrier
- to define the properties of the vapour barrier and installation requirements

RAIN PENETRATION

GENERAL

The National Research Council BPN 12 (May 1979) states the following:

There are three essential requirements for the rain penetration of masonry walls:

- A film of water on the wall.
- An opening in the wall to permit the entry of water.
- A force to drive the water through the opening.

These factors work in combination – the absence of any one of them will eliminate the problem – but unfortunately it is difficult to visualize the absence of any of the factors during rain storms.

As BPN 12 indicates, there will always be water on some part of masonry walls when it rains. While it is possible to minimize this by shielding or directing water away from parts of a building, many parts will still get wet. Masonry walls are by nature a network of jointed materials, with the potential for cracks along all bond lines, through masonry units or through sealed joints and junctures with other materials.

These are some of the forces that cause rain penetration:

- air pressure differential
- kinetic energy of the rain drop
- gravity
- capillary suction
- surface tension

The major cause of water penetration is the pressure differential that can be created by the wind blowing at wall surfaces. Higher air pressure on the exterior of the wall drives the water into the interior, which has lower air pressure. Because of the air pressure differential, the water is driven through even the smallest of openings – it is literally sucked in.

The kinetic energy of rain drops drives in water primarily through openings larger than 3 mm (0.12 in.).

For water entry caused by gravity, openings also have to be significant, at least 0.5 mm (0.02 in.), and sloping toward the inside.

Capillary suction, caused by forces developed by surface tension, can draw water up into small cracks and openings.

Surface tension causes water to cling to a surface, where it can run through an opening.

COMMON CAUSES OF WATER PENETRATION

The following are common flaws in design and construction that allow excessive water from rain or melting snow to enter the building envelope to cause damage:

- poor detailing, construction or maintenance of roof parapets
- water from non-absorbent surfaces, such as sloping roof surfaces or sloping glass skylights, flowing down onto vertical wall surfaces
- poorly constructed masonry walls with mortar joints not fully filled and poorly compacted and finished, allowing water to enter at openings in the mortar joints
- lack of proper flashings at window or door openings and at the foundation level
- masonry in contact with the ground and exposed to splash water
- cracks in masonry induced by excessive foundation settlements, lack of movement joints or structural deflection of the supporting structure
- horizontal masonry surfaces with inadequate drainage, allowing water to saturate and deteriorate the masonry as a result of freeze-thaw action

WATER AND MOISTURE CONTROL

DETERIORATION RESULTING FROM WATER AND MOISTURE

Water and moisture enter building materials as a result of condensation, rain or melting of snow. Water contributes to the deterioration of building materials through the following processes:

- dimensional change (With a change in moisture content, the dimensions of many building materials change considerably. This may affect their connection to the surrounding materials. For example, clay brick expands with increased moisture content.)
- metal corrosion
- freeze-thaw effects (When water saturation of some materials exceeds a certain limit (generally 60–70%), repeated cycles of freeze-thaw can lead to very rapid deterioration.)
- spalling
- efflorescence
- leaching (Water moving through concrete and mortar can cause a steady deterioration of these materials by leaching calcium from the cement.)
- displacement (Freezing water can displace cladding materials.)

CONTROL OF WATER AND MOISTURE RESULTING FROM CONDENSATION

Condensation in and on building elements that separate conditioned interior space from exterior space and the transfer of heat, air and moisture through these elements can be controlled at a rate that will not allow enough moisture to accumulate to cause deterioration or other adverse effects. This is accomplished by appropriately designing and placing the following structural elements within the wall assembly and system:

- a vapour barrier
- an air barrier system
- materials to resist heat transfer

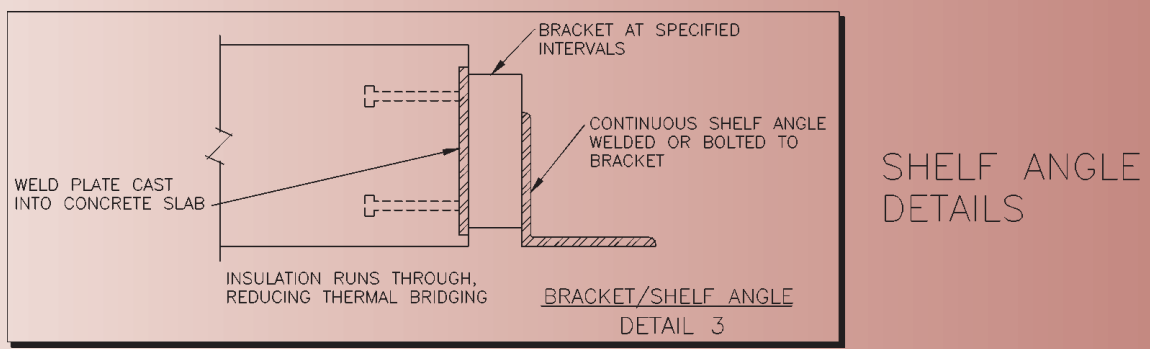
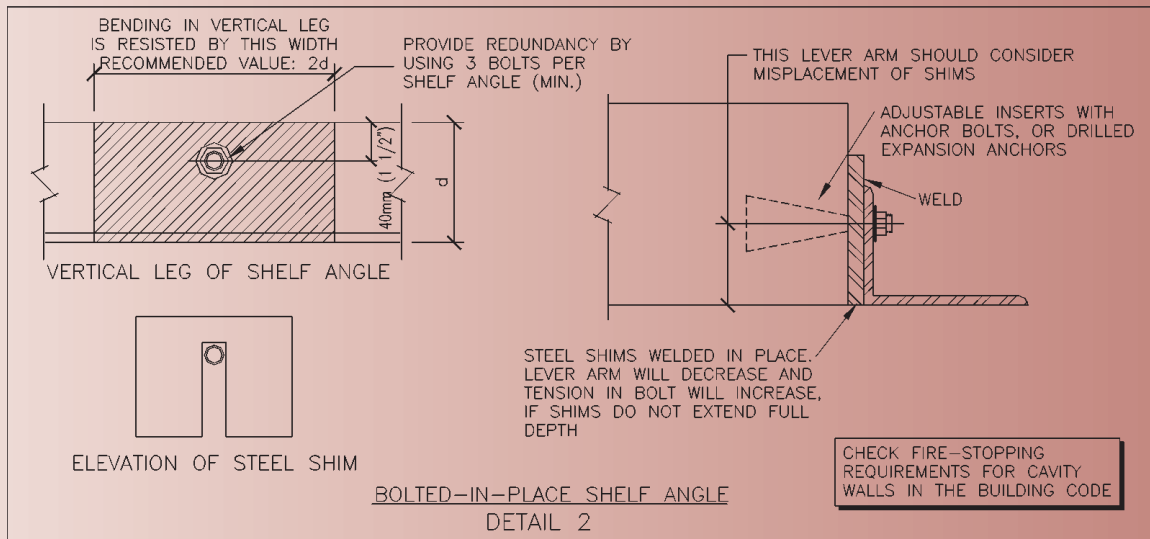
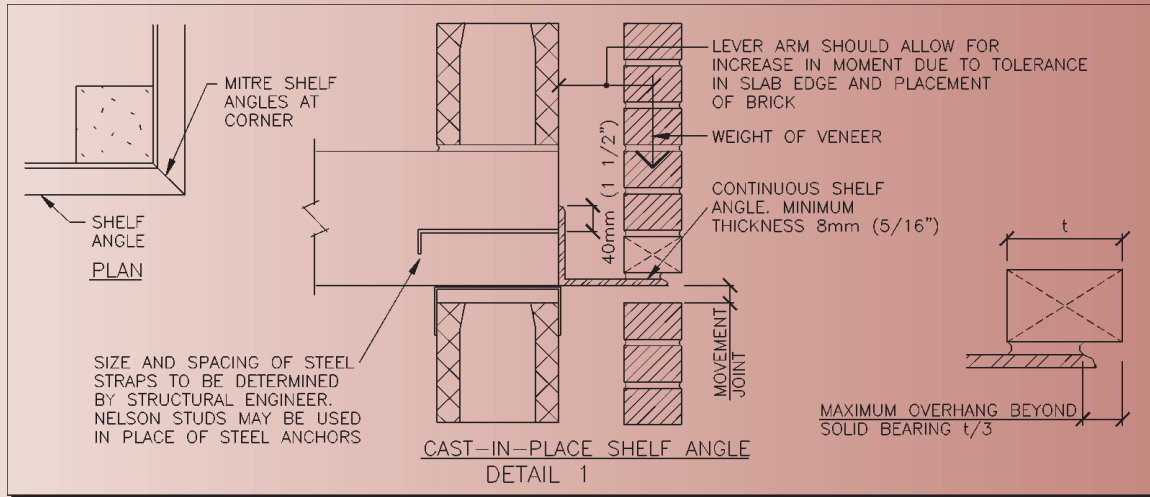

Figure 3.4: Shelf Angle Details

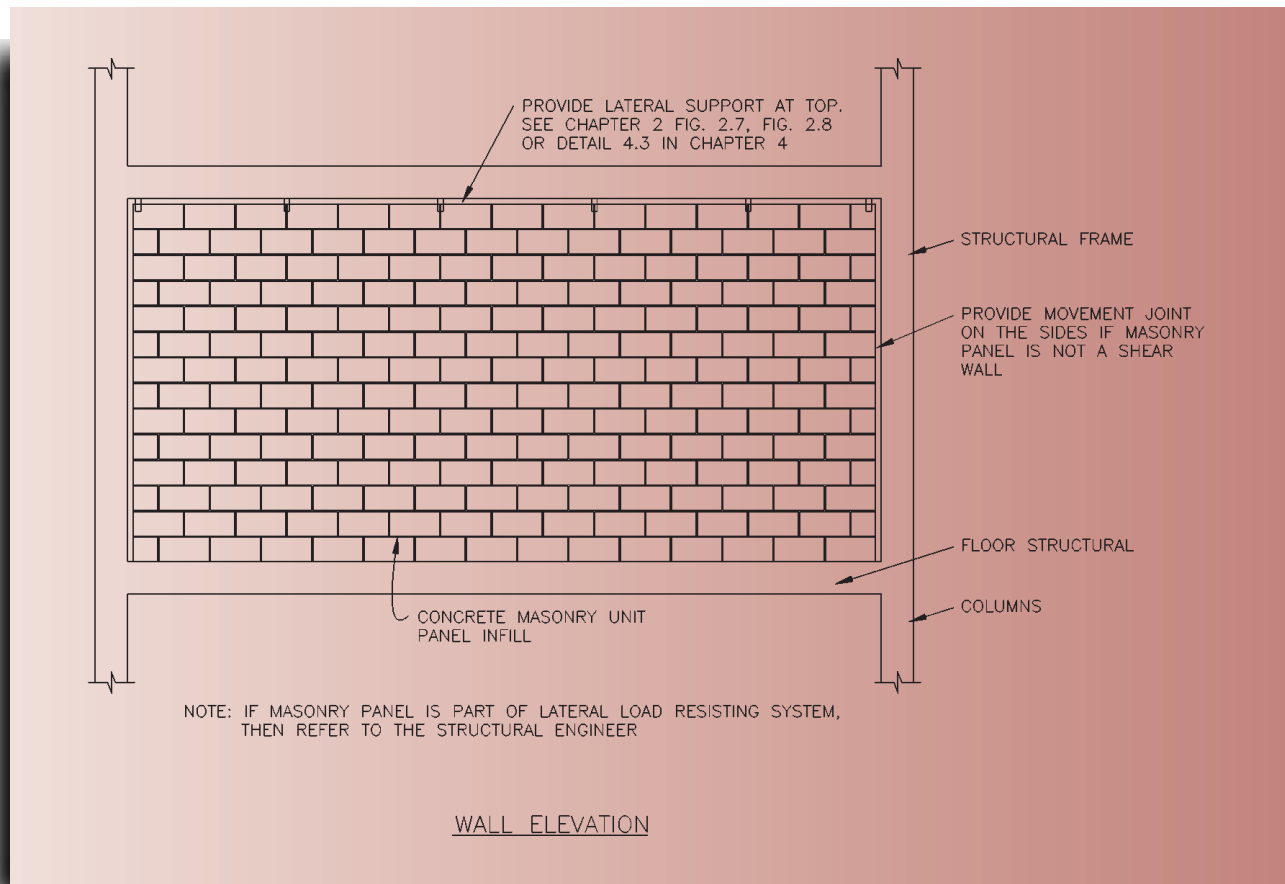

Figure 3.5: Location of Movement Joints

The vapour barrier must be installed in the wall assembly where the temperature of the inside air in contact with it remains above its dewpoint temperature. The air barrier in the wall assembly need not be located on the warm side of the insulation, but there are advantages to doing this. If the air barrier is installed on the cold side of the insulation, it cannot also be used a vapour barrier.

CONTROL OF WATER RESULTING FROM RAIN AND SNOW

During a rain storm, most of the water affects the building at the top two storeys. The parapets, the junction of the parapet with roof, and the junction of the other vertical wall elements and the roof are the most vulnerable to water penetration. Any horizontal projections from the main vertical face are also vulnerable.

The following strategies will go a long way in controlling water penetration:

1. Attempt to minimize the quantity of water that comes in contact with the exterior wall.
2. Attempt to minimize openings (joints and junctions) in the exterior wall.
3. Attempt to neutralize all the forces that can move water through the openings.
4. Drain out the water that enters.

Strategy 1: Attempt to minimize the quantity of water that comes in contact with the exterior wall.

- Provide roof overhangs to reduce the quantity of water coming into contact with the wall.
- Do not drain water from a sloping roof or skylight directly to the wall. Instead, provide a trough to catch water at junctions or sufficient overhang to drain water away from the wall.
- Cap flashings at window sills, roof parapets and other horizontal masonry surfaces, and ensure that overhangs and drips are provided to drain water away from the wall.
- Ensure that cap flashings at roof parapets are lapped using S-lock joints to prevent water leaking at joints in the cap flashing (see CMHC’s *Best Practice Guide – Flashings*).
- Keep exterior wythe of masonry a minimum of 150 mm (6 in.) above the grade level at the exterior. Avoid water splash by providing proper drainage of roof water.
- Eliminate direct spray from ground sprinkler systems.

Strategy 2: Attempt to minimize the openings in the exterior wall.

- Ensure full head and bed joints, with mortar compacted and tooled to a flush concave joint.
- Ensure properly designed, constructed and maintained sealant joints at all movement joints, window and door frame and masonry interfaces, and other openings.
- Prevent cracking in masonry walls. Follow the guidelines later in this chapter, under “Guidelines to Accommodate Movement.”
- Ensure proper design, construction and maintenance of parapet wall flashings.

Strategy 3: Attempt to neutralize the forces that move water through the openings.

- Reduce the air pressure differential by applying the pressure-equalized rain-screen concept at the brick/block cavity and sealant joint.
- Provide overhang and drip at flashings and sills to neutralize surface tension.
- Slope surfaces that are likely to retain water to make them drain water away from the wall.
- Overlap materials to counter the effects of the momentum of water, e.g., by lapping the vertical leg of flashing over the brick at the roof parapet cap flashing.

Strategy 4: Drain out the water that enters.

- Provide flashings in the cavity over openings at shelf angles and at the foundation level to drain any water that enters the cavity.
- Provide drainage openings at flashings to let water out.

PRESSURE-EQUALIZED RAIN-SCREEN CONCEPT

An air pressure differential across a wall is created by the following factors:

- blowing wind
- stack effect
- mechanical ventilation pressurization

Although it is impossible to eliminate these factors, a pressure-equalized rain-screen wall can help to counteract them. The principles of the pressure-equalized rain-screen wall are illustrated in [Figure 3.2](#), (p. 3-9). The principles involved in the design of a pressure-equalized rain screen wall are as follows.

A rain-screen wall incorporates two walls separated by an air space or cavity, as shown in [Figure 3.2](#), (p. 3-9). To isolate the cavity from variations in air pressure from inside the building, an airtight air barrier is required. Vents are provided in the rain-screen cladding to equalize the pressure between the exterior and the cavity. If sufficient venting is provided, pressure variation across the rain-screen cladding will approach zero. This reduces the amount of water forced through the rain screen. Essentially, the cavity becomes a part of the exterior and the pressure differential is transferred to the inner air barrier wall. Because this inner air barrier is airtight, stack effect and mechanical ventilation, which are generated inside the building, are effectively controlled.

Theoretically, in a pressure-equalized rain-screen wall, there should be no wind load on the rain-screen cladding. In practice, a time lag occurs between the application of the wind load and pressure equalization in the cavity. As a result, pressure is exerted on the rain-screen cladding. During the time lag, a pressure differential is created across the exterior veneer cladding, which moves water through the veneer.

Under dynamic wind conditions, sometimes the wind pressure on the outside will decrease. As a result of the time lag involved in pressure equalization, the pressure in the cavity will sometimes be higher. This will tend to force out any water in the cavity, which is an added advantage of the pressure-equalized rain screen.

The action of wind flowing around a building creates pressures and suctions, distributed over the entire surface of the building. If the cavity is continuous, this allows the lateral flow of the air within the cavity, and pressure equalization does not occur. To prevent the lateral flow of air within the cavity, it must be divided into compartments. Research is still under way to determine the spacing of baffles to form compartments. Current guidelines for the design of the pressure-equalized rain-screen wall system are based on static theory and may be insufficient for the design of a wall with dynamic pressure, as with wind-driven rain. The following can be used as a guide until new guidelines are available:

- The cavity space must be closed at all corners of the building to prevent air from going around the corner to feed the high suctions that occur on the adjacent wall faces. In addition, spaces of 3-6 m (10 ft.)-(20 ft.) width horizontally should be compartmentalized. The compartments should be closed at the roof level.
- In brick veneer/CMU construction, where a waterproof membrane may be applied to the exterior face of the concrete masonry to serve as both air and vapour barrier, and durable, water-resistant materials and components have been used in the wall assembly, any advantages of vertical compartmentalization is questionable, even at wall corners in high-rise construction, since the waterproof membrane will be an effective barrier to the ingress of moisture into interior space.

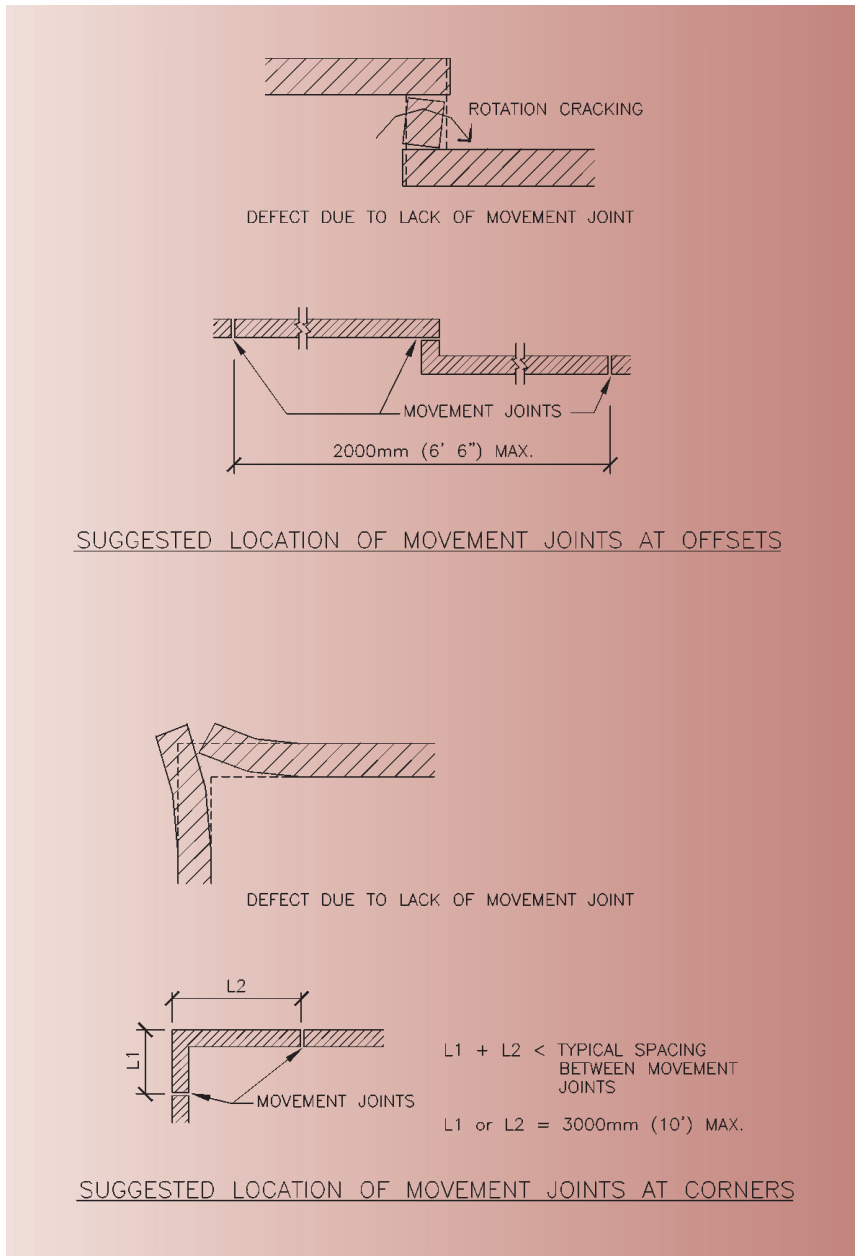
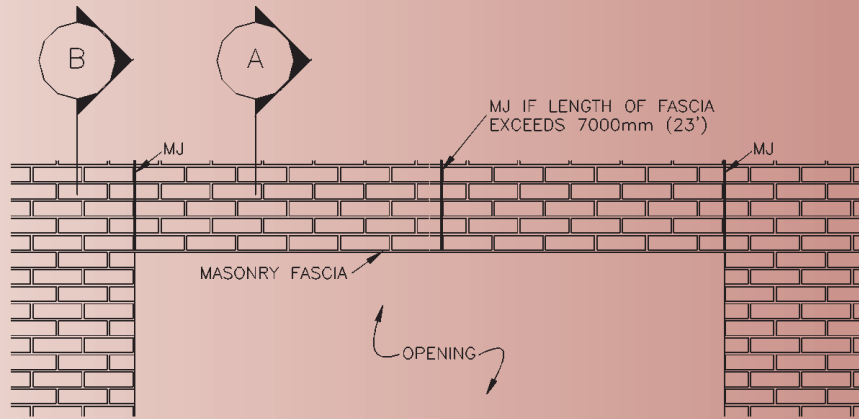
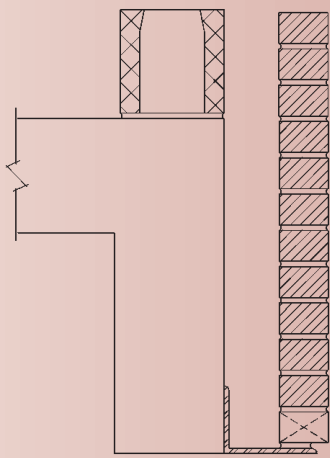

Figure 3.6: Movement Joints



(MJ) MOVEMENT JOINTS AT MASONRY FASCIA CONNECTING TO SOLID WALLS OR AT CHANGE IN CROSS-SECTION



SECTION 'A'

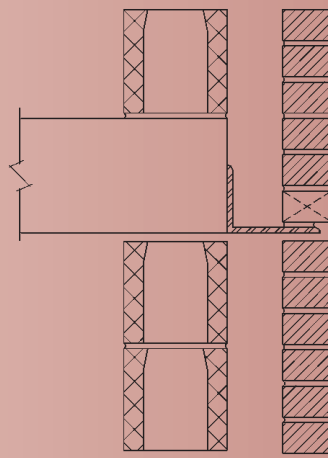

SECTION 'B'

Figure 3.7: Location of Movement Joints

FIRE STOPPING

As masonry wall construction is an effective non-flammable construction, it is inherently effective in controlling fire spread and maintaining the integrity of the wall structure during and after a fire. However, to control the spread of fires through the veneer cavity within floor levels and between floor levels, the wall construction must include adequate details for fire stopping.

Fire stopping is used to prevent the spread of fire in building assemblies and concealed spaces. The function of fire stopping is to cut off fire by preventing the flow of oxygen into a space. Continuous steel shelf angles used to support the veneer effectively seal the cavity from flame spread between floors within the cavity. Sheet-metal closure flashing, used to compartmentalize the wall cavity for pressure equalization of the rain screen, also effectively provides horizontal fire stopping.

Based on the 1995 NBCC, the following guidelines are presented for general information:

- If the insulation in the cavity is noncombustible, fire stops are not required.
- If the cavity is completely filled with insulation, fire stops are not required.
- When the concealed air space is 25 mm (1 in.) or less, fire stops are not required.
- For concealed air spaces greater than 25 mm (1 in.) in walls with insulations with flame spread ratings greater than 25, the following apply:
 - Fire stops are required at each floor. If floor-to-floor distance is more than 3 m (10 ft.), additional fire stops are required in the form of a horizontal sheet-metal flashing, 0.38 mm (0.015 in.) galvanized sheet steel with drainage holes.
 - Vertical fire stops are required at a maximum distance of 20 m (65.6 ft.), measured horizontally. Vertical fire stops may be in the form of 0.38 mm (0.015 in.) sheet metal or proprietary fire stop products made of noncombustible materials.
- For concealed air spaces greater than 25 mm (1 in.) in walls with insulations with flame spread ratings of less than 25, the following apply:
 - Horizontal fire stops are required at a distance of no greater than 10 m (32.8 ft.).
 - No vertical fire stops are required.

The placement of fire stops should be coordinated with that of shelf angles, flashings, ties and movement joints. [Detail 4.3b](#) (p. 4-35) illustrates use of the mineral-fibre fire stop. Readers must consult the 1995 NBCC and their local codes and regulations for more detailed information.

DESIGN OF MASONRY TO ACCOMMODATE MOVEMENT

It is said that the various elements that form a building are in a constant state of movement. All building materials contract and expand because of various physical processes taking place. If all the materials in a building were free to conform to their natural state, there would be no cracking. But this is not the case. The way materials are connected in a building restrains their movement. This restraint introduces stresses, and if the stress exceeds the capacity of a material or connection to resist it, then cracking takes place.

The designer must be knowledgeable of products and be aware, in both design and construction, of ways to minimize or accommodate movement to reduce or eliminate failures in serviceability. The methods currently employed for controlling cracking generally involve reducing movements through material selection and controlling and accommodating movement through design (suitable location, frequency and width) of movement joints.

Any of the following may cause deformations of masonry, acting separately or in different combinations:

- volume changes brought on by changes in temperature
- volume changes brought on by changes in moisture
- movements of elements supporting the masonry (elastic deformations, shrinkage, creep and settlement)

TEMPERATURE CHANGES

All commonly used building materials expand or contract as a result of temperature changes. Materials differ in their response to temperature changes. [Table 3.3](#), (p. 3-22) shows average coefficients of thermal expansion for commonly used building materials.

Temperature differentials used for estimating expansion or contraction of masonry and other non-masonry elements should be mean wall temperatures, based on the 2.5% January and July temperatures, plus adjustments for solar-radiation heat loss and heat gain. In a masonry wall with cavity, the exterior masonry facing will be subject to the full range of temperature variations. The concrete-block backing inside the building will be subject to a much narrower variation in temperature, depending on the temperature at which the units were laid. This will also induce differential movements between the exterior facing, which is subject to greater temperature changes, and interior concrete-block backing, which is subject to lesser temperature changes. Unless rigid connection is specifically recognized in the design and appropriately provided for, care should be taken to ensure that the elements tying the facing and the backing together have some flexibility, to allow for the differential movements. Other than those ties specifically marketed to provide shear connection between wythes, the currently available ties for traversing the minimum air spaces recommended for brick veneer/CMU systems provide this flexibility.

MOISTURE CHANGES

Most building materials, with the exception of metals, expand with increase in moisture content and contract with loss of moisture.

Concrete Products

Shrinkage must be recognized in the design of walls containing CMUs. Although the greatest shrinkage occurs within the first few months after manufacture, shrinkage continues indefinitely at a decreasing rate. Many factors affect the shrinkage of concrete-block masonry. The following are the two most significant:

- aggregate type (density of units)
- the amount of moisture in the masonry materials at the time of laying the wall

Appropriate product selection, that is, the specification of moisture-controlled units, will greatly control these factors and the amount of residual shrinkage of the units in the wall (see moisture-controlled units in Chapter 2, under “Physical Properties”).

Shrinkage prediction for concrete masonry walls is usually based on the assumption that the mortar joints do not exist, that the walls are unreinforced and unrestrained at their boundaries, and that the panel is composed entirely of unit block. As a consequence, the predicted shrinkage movements calculated from the values provided in [Table 3.3](#), (p. 3-22) are likely to be somewhat greater than in practice.

CMUs must never be wetted prior to laying.

Clay Products

Clay brick units expand slowly over time if they are exposed to water or moisture. This expansion is irreversible by drying at atmospheric temperatures. A brick is smallest after it comes out of the kiln and increases in size over time. Most of the expansion takes place in the first few months but continues for a longer period. An average design value for long-term moisture expansion of 0.0002 mm/m (0.02%) is recommended for use in calculating expansion of veneer walls. A clay brick panel 3 m (10 ft.) long may expand by about 0.6 mm (0.023 in.).

ELASTIC DEFORMATIONS, SHRINKAGE AND CREEP

Stresses are generated in structural members of a building frame subjected to loads, either as a result of their own weight or their live load. These stresses give rise to deformations. In flexural or bending members, such as slabs and beams, these loads cause the slabs and beams to deflect. Masonry walls are usually quite stiff, compared with the flexibility of the supporting beams and slabs. Without appropriate design, this incompatibility can sometimes lead to cracking in the masonry walls. To control cracking, supporting slabs and beams should meet the minimum stiffness requirements recommended by CSA S304.1.

Elastic shortening of concrete walls and columns in high-rise buildings is compounded by creep and shrinkage. Beam and slab deflections and elastic and creep shortening of columns act to move the walls downward. This downward movement must be accommodated using movement joints, as illustrated in [Figure 3.4, Detail 1](#), (p. 3-13).

Table 3.3: Typical Deformation Properties for Some Common Building Materials

Material	Thermal movement in mm/m per 100°C (in./ft. per 100°F x 10 ⁻³)	Shrinkage in mm/m (in./ft.)		Creep Coefficient (Φ)
		Initial Drying	Cyclical Change	
Plain concrete Normal weight	1.0 (6.7)	0.5 (.006)	±0.1 (±0.0012)	3
Glass	0.9 (6.0)	0 (0)	0 (0)	0
Masonry clay	0.7 (4.7)	-0.2 (-0.024) <i>(expansion)</i>	±0.1 (±0.0012)	1
Calcium silicate	1.0 (6.7)	0.2 (0.0024)	±0.1 (±0.0012)	2
Concrete (normal weight)	1.0 (6.7)	0.4 (0.0048)	±0.2 (±0.0024)	2
Concrete (autoclaved lightweight)	0.75 (5.0)	0.6 (0.0072)	±0.2 (±0.0024)	2
Metal				
Aluminum	2.4 (16.0)	0 (0)	0 (0)	0
Copper	1.7 (11.3)	0 (0)	0 (0)	0
Lead	3.0 (20.0)	0 (0)	0 (0)	0
Steel	1.2 (8.0)	0 (0)	0 (0)	0
Natural Limestone				
Limestone	0.4 (2.7)	—	±0.1 (±0.0012)	0
Marble	0.5 (3.33)	—	±0.1 (±0.0012)	0
Sandstone	1.2 (8.0)	—	±0.1 (±0.0012)	0

Source: Adapted from the *Supplement to the National Building Code of Canada 1990*

The side sway of a structural frame caused by winds or earthquakes may cause distress in infill masonry if the masonry is built tightly into the frame and not designed to resist these forces. The connection of masonry without load-bearing infill masonry should be flexible and allow vertical and lateral sway of the frame, to avoid unnecessary distress. In some cases, however, the infill-masonry wall is considered a part of the system for resisting lateral loads. In that case, the details of connection should be rigid enough to transfer lateral forces. The advice of an experienced structural engineer should be sought to devise proper detailing. See [Figure 3.5](#), (p. 3-14).

FOUNDATION MOVEMENTS

Foundation movements and differential settlements often cause cracking in masonry walls supported on foundations. Movement joints must be provided at strategic locations to allow foundation movements to take place without cracking the masonry. Footings may also be designed to have comparable settlements to minimize differential movements.

EFFECTS OF MOVEMENT

The following examples illustrate the consequences of movements, if design details fail to account for their effects. In addition to causing cracking in the walls, the resulting potential for water penetration under exterior exposures can accelerate masonry deterioration.

Long Walls

Long walls or walls with large distances between movement joints may be especially subject to distress within the wall. In case of expansion, the sealants in the joint may be forced out; in the case of contraction, cracks may develop between the joints. If the wall is not continuous but has openings with piers between openings, diagonal cracks may develop in the piers.

Corners

Improperly locating expansion joints in walls can lead to cracking at the corners. Perpendicular walls will expand in the direction of the corner, thus causing rotation and cracking near the corner. See [Figure 3.6](#), (p. 3-17).

Offsets and Setbacks

Vertical cracks are quite common at wall setbacks or offsets, unless movement is accommodated. When parallel walls expand toward the offset, the movement produces rotation of the offset, causing vertical cracking. See [Figure 3.6](#), (p. 3-17).

Shortening of Structural Frame

In concrete-frame buildings, the frame shortens vertically, as a result of load, shrinkage and creep. In steel buildings, creep and shrinkage are not significant; other effects are the same as in concrete buildings. Although the masonry veneer does not shrink or shorten, it may expand. When shelf angles are present to support the masonry veneer, the shelf angles will tend to bear on the masonry below, unless a movement joint is provided below the shelf angle. A high concentration of stress can develop, causing spalling of masonry veneer, bowing of masonry veneer, cracking and other difficulties. See [Figure 3.3](#), (p. 3-10).

Foundations

Concrete foundation walls shrink; clay masonry veneer expands. This differential movement may cause distress at the interface if movement is restrained. This may result in cracking of the concrete at the corners or movement of the brick at the corners.

Deflection

Deflection cracks are typically wider at the support member and narrower at the top. Deflection cracks occur when the supporting lintel, beam or slab suffers excessive deflection.

Differential Settlement

Differential settlement cracks occur when supporting foundation walls settle differently at different locations along the masonry wall. These cracks typically have a zigzag appearance.

Embedded Materials

Columns rigidly connected to masonry, continuous joint reinforcement across movement joints, or other embedded items can cause cracking of masonry when they move or expand. Sometimes structural steel columns and beams embedded in the masonry reduce a cross-section of the masonry wall, resulting in cracking at that location. Movement joints should be provided at such locations.

MOVEMENT JOINTS

Horizontal and vertical movement joints between masonry elements and between masonry and non-masonry elements relieve the stresses from vertical deformations and facilitate movement between elements from horizontal deformations. Failure to provide or to adequately detail or construct movement joints is one of the principal causes of distress in masonry walls. The importance of a specific type of building movement varies greatly in different parts of the country, or with the configuration of the structure.

Because a large number of factors must be considered in calculating wall crack resistance or movement joint spacing, and the quantitative values for many of these variables can only be approximated, qualitative methods have had to be used to establish the location and frequency of placement of movement joints, such as in concrete structures. Some guidance can be given in the placement of movement joints, provided in [Table 3.4](#), (p. 3-32), but location based on the following must also be considered:

- Vertical movement joints are required:
 - near corners (see [Figure 3.6](#), p. 3-17);
 - where there are changes in wall height (see [Figure 3.7](#), p. 3-18);
 - at offsets (see [Figure 3.6](#), p. 3-17);
 - in areas where differential settlements are anticipated; and
 - where structural steel or other items have penetrated masonry.
- Horizontal movement joints are required below shelf angles.
- Horizontal and vertical movement joints are required around masonry panels built into structural frames, unless the masonry panels are designed to act as shear walls (see [Figure 3.5](#), p. 3-14).

Published data on deformations of masonry, such as those in [Table 3.3](#), p. 3-22, are generally mean or conservative values, representing a wide range of products and the masonry unit itself, rather than the constructed, frequently restrained masonry element. They are intended to give the designer some indication of the extent of movement, usually for the calculation of differential movements between materials. Such calculations are almost always quite conservative in their results.

The Canadian Masonry Research Institute is conducting a study of vertical movements resulting from temperature and moisture changes in unrestrained masonry brick veneer/CMU walls. The focus is on in-service masonry structures, with interior conditioned space, exposed to the exterior temperature extremes common in Canada. The unrestrained configuration and the materials selected for the study – “green” concrete block and a green clay brick – and the rapid speed of construction employed in this study represent the least desirable conditions for controlling movement in a masonry structure. Yet, using an 11 m (32.84 ft.) gauge height, only minimal movement was recorded during the first 12 months after completion of the structure:

- CMU backing, 4.5 mm (0.18 in.) shrinkage
- exterior brick veneer, 3.0 mm (0.12 in.) shrinkage
- differential movement, 1.5 mm (0.06 in.)

The movements were considerably less than anticipated from calculations using published coefficients, and the exterior brick veneer walls shrank rather than expanded, contrary to what is often claimed in the literature. These

results are a reminder that mortar contributes to wall performance and that the movements of masonry elements cannot be accurately predicted using data from laboratory studies of the masonry unit. These results also lead us to conclude that load-bearing stress in high-rise masonry veneer is more likely solely attributable to structural frame shortening and the deflections of elements supporting the masonry than to brick veneer “growth” or a combination of these factors.

Width of Movement Joints

Vertical Joints

The width of a movement joint depends on the amount of movement expected. In a clay brick facing the amount of movement depends on the following factors:

- length of panel between the joints, L (m) (in.)
- annual range of extreme high and low temperatures of the facing, T
- coefficient of thermal expansion, C (mm/m per °C (in./ft. per °F); see [Table 3.3](#), p. 3-22) (For clay brick $C = 0.007$ mm/m per °C.) ($C = 4.7$ in./ft. $\times 10^{-5}$ per °F)
- coefficient of moisture expansion, M (for clay brick $M = 0.2$ mm/m) (0.0024 in./ft.)

Expansion due to freezing has been ignored in this example. Freezing expansion does not occur until wall temperatures are below -10°C (14°F). Further, units must be saturated when frozen to cause expansion.

Unrestrained movement (W) of clay brick facing may be estimated by the following formula:

$$W = (C \times T + M) L$$

Annual temperature range T will depend on the following factors:

- temperature at the time of installation of the brickwork, T_1
- maximum mean temperature of the wall, T_2
- minimum mean temperature of the wall, T_3

Because the temperature at the time of the installation is difficult to determine, it is conservative and simpler to assume the annual temperature range based on $T = T_2 - T_3$. The following methods for determining T_2 and T_3 are based on the procedure recommended in Commentary D of *Supplement to the National Building Code of Canada 1990*.

$T_2 = 2.5\%$ July temperature + temperature increase in excess of ambient temperature resulting from solar radiation (For a masonry wall, the increase is 10°C (50°F) for light-coloured units and 15°C (59°F) for dark-coloured units.)

The 2.5% July temperature (dry) is defined as the temperature at or above which only 2.5% of the hourly outside air temperatures in July occur.

$T_3 = 2.5\%$ January temperature + temperature decrease below ambient temperature resulting from radiation loss into a dark clear sky (For a masonry wall, this decrease is 5°C (41°F .)

The 2.5% January temperature is defined as the temperature at or below which only 2.5% of the hourly outside air temperatures in January occur.

Because of solar heat gain in summer and radiation heat loss in winter, the range of temperatures building elements undergo is greater than that of the ambient temperature.

For light-coloured units in Ottawa, the following applies:

$$T = T_2 - T_3$$

$$T = (30 + 10) - (-25 - 5) = 70^\circ\text{C} (158^\circ\text{F})$$

For dark-coloured units in Ottawa, the following applies:

$$T = (30 + 15) - (-25 - 5) = 75^\circ\text{C} (167^\circ\text{F})$$

For a 7 m (23 ft) long, light-coloured, clay brick wall between movement joints, movement is calculated as follows:

$$W = (0.007 \times 70 + 0.2)7 = 5.53 \text{ mm} (0.22 \text{ in.})$$

Horizontally Aligned Movement Joints

Horizontally aligned movement joints are provided below the shelf angles to allow the brick facing and the structure to move freely of each other.

Brick facing expands and contracts as a result of temperature changes, and for this example, it is assumed that it expands because of moisture increase. The structure shortens as a result of elastic deformations, creep and drying shrinkage. Deflection of the structure resulting from flexure may also close the gap below the shelf angle. All of the above factors have to be accounted for in determining the width of the movement joint or the gap between the top of brick facing and the underside of the shelf angle.

Unrestrained movement expected at the horizontally aligned movement joint below the shelf angle may be estimated using the following formula:

$$W = (C \times T + M)L + (S \times L) + ES \times \phi \times L + DF$$

where

L is the distance between shelf angles in metres (feet).

S is the shrinkage coefficient in millimetres per metre (in./ft.). Applicable to the concrete frame only, assume 0.5 mm/m(0.006 in./ft.). Use 0.4 mm/m (0.005 in./ft.) assuming 20% of shrinkage would have already taken place by the time brick is installed.

ES is the elastic shortening coefficient, in millimetres per metre, applicable to the structure. In the absence of more precise data, assume *ES* = 0.4 mm/m (0.005 in./ft.).

ϕ is the creep coefficient, applicable to concrete structural frame only. Use a value of 1.5, assuming that some of the creep will have already taken place by the time brick is installed.

DF is the difference in millimetres (inches) of flexural deflection (instant and long term) between the perimeter structural members at the top and bottom of the brick panel. Between framing members of equal stiffness (e.g., typical floors) this value will be equal to the difference in live-load deflections. In the case of an upper floor and the foundation wall, this figure will be the full value of instant plus additional long-term deflection. For this example, assume *DF* = 3 mm (0.12 in.).

For an apartment building with a floor-to-floor height of 2700 mm (106 in.), the amount of movement below the shelf angle, for typical floors, may be estimated as follows:

$$W = (0.007 \times 70 + 0.2) 2.7 + (0.4 \times 2.7) + 0.4 \times 1.5 \times 2.7 + 3 = 7.56 \text{ mm} \\ (0.3 \text{ in.})$$

(All data used is similar to the previous example for a vertical joint.)

A gap of more than 7.56 mm (0.3 in.) must be provided below the shelf angle.

The value of *DF* has been assumed as 3 mm (0.12 in.). The exact value should be calculated by the structural engineer. Between the foundation level and the first upper level this value will be quite a bit larger than for typical floors.

Sealant Joints

As described earlier, temperature differential is assumed as the full annual temperature range. Therefore, the total compression-expansion range of the sealant is considered in this example.

If a sealant with movement capability of $\pm 25\%$ is considered for a joint, it will allow a total yearly percentage movement capability of 50%. Thus, the minimum joint width can be estimated by dividing the expected annual movement for the vertical joint of 5.53 mm (0.22 in.) by 0.5, giving 11.06 mm (0.44 in.). A vertical movement joint is typically sized to resemble a mortar joint, usually from 10 to 12 mm (0.4 in. to 0.5 in.). This procedure is based on *Canadian Building Digest* No. 155.

For a horizontal joint at a shelf angle, the required minimum width of a sealant joint for the example given is 7.56 mm (0.3 in.), divided by 0.5, giving 15.12 mm (0.6 in.).

GUIDELINES TO ACCOMMODATE MOVEMENT

The following guidelines are recommended for accommodation of movement:

- Provide movement joints (at appropriate locations and frequency and with sufficient width), as described above.
- Provide joint reinforcement (sufficient area and frequency of placement) as required by CSA Standard S304.1.
- Do not continue joint reinforcement through the movement joint.
- Use masonry materials and workmanship to conform to relevant standards.
- Keep deflection of the structural system within limits specified in the relevant standards.

STRUCTURAL DESIGN

GENERAL DESIGN REQUIREMENTS

A brick facing, concrete-block backup assembly with a cavity between the wythes can be designed as either a cavity wall or a veneer wall.

In a cavity wall, the wythes are tied together with metal ties to make the two wythes act together in resisting lateral loads.

In a veneer wall, the block backing resists all lateral loads; veneer depends on block backing for resisting lateral loads from winds and earthquakes. Veneer is tied to the block backing with metal ties.

Brick-facing and concrete-block assemblies must be capable of safely resisting the following types of loads:

- dead loads
- live loads
- loads caused by winds
- loads caused by earthquakes

Please see part 4 of the NBCC for guidance on specified loads.

The structural design of the wall assembly must use one of the two design methods recommended in CSA CAN3-S304-M84 or S304.1-94.

EARTHQUAKE REINFORCEMENT

In velocity- or acceleration-related seismic zone 2 or higher, masonry walls that form a part of the exterior cladding must be reinforced in accordance with S304.1-94. The requirements for reinforcement are different for load-bearing and non-load-bearing walls. Reinforcement requirements for major centres across Canada are given below, based on information in the *Supplement to the National Building Code of Canada 1990*. If either Z_v or Z_a is 2 or higher, reinforcement is required.

Masonry veneer or facing is not required to be reinforced to withstand earthquakes. The structural backing must be designed to resist earthquake forces generated by the facing and the backing.

The following information is applicable to earthquake forces only. There may be other structural reasons for reinforcing a masonry wall; this decision should be made in consultation with the structural engineer.

- Vancouver – reinforcement required
Reinforcement is required in most locations in British Columbia. Refer to the NBCC supplement for cities that require reinforcement.
- Calgary – no reinforcement required
Edmonton – no reinforcement required
No reinforcement is required anywhere in Alberta.
- Saskatoon – no reinforcement required
No reinforcement is required anywhere in Saskatchewan.
- Winnipeg – no reinforcement required
No reinforcement is required anywhere in Manitoba.
- Many cities in Ontario need reinforcement, e.g., Ottawa, Brockville, Carleton Place, Cornwall. Refer to the NBCC supplement for cities that require reinforcement.
Toronto – no reinforcement is required.

- Most cities in Quebec require reinforcement. Refer to the NBCC supplement for cities that require reinforcement.
- New Brunswick – most cities require reinforcement.
- Nova Scotia – some cities in Nova Scotia require reinforcement. No reinforcement is required in Halifax.
- Prince Edward Island – no reinforcement is required anywhere in Prince Edward Island.
- Newfoundland – most cities do not require reinforcement. Refer to the NBCC supplement for cities that require reinforcement.
- Yukon – reinforcement is required in all cities.
- Northwest Territories – some cities require reinforcement.

SHELF ANGLES

Function

The shelf angle, commonly used to support masonry (non-load-bearing veneer) construction, serves two functions:

- to support all dead loads and live loads imposed on the veneer; and
- to prohibit transfer of these loads from upper to lower non-load-bearing panel walls. (This ensures that the masonry veneer serves as a non-load-bearing element throughout the design service life of the building envelope. Providing shelf angles at regular vertical intervals breaks the wall into smaller panels and helps control the effects of temperature changes and frame movements.)

The following guidelines are for the structural design, construction and installation of shelf angles.

Structural Design

The shelf angle is not a masonry element and, therefore, *the requirements for strength design of shelf angles are not covered by masonry standards.*

NBCC Part 9 Buildings (low-rise construction)

- Masonry veneers may be supported from the foundation and may extend 11 m (36 ft.) in height without needing intervening shelf angles.
- Part 9 does not provide requirements for the use, placement and design of shelf angles used in *non-wood-frame* low-rise construction. However, it is reasonable to assume that designs using shelf angles in non-wood-frame construction must satisfy the requirements of Part 4 of NBCC.

NBCC Part 4 Buildings

Part 4 references CSA Standard S304.1, “Masonry Design of Buildings,” from which the designer may choose one of two compliance paths:

- a) The Empirical Design Compliance Path, a simple prescriptive path:
 - Shelf angles must be placed at not more than 3.6 m (11.8 ft.) (about one storey) for non-wood-frame buildings less than 20 m (65.6 ft.) in height.
- b) The Engineered Design Compliance Path, a rational, engineered design approach:
 - For high-rise buildings, it is common practice to provide shelf angles at every floor level above the ground floor and in some cases to use no shelf angles up to 11 m (36 ft.) above the bearing level. But this practice is empirically based and need not be followed when using the engineered design compliance path.

- Engineered design uses a performance approach and permits flexibility; it places no prescriptive limits on placement and spacing; it allows the designer to make location and frequency of placement of shelf angles consistent with function, strength and serviceability requirements.
- **Strength:**
 - CSA S304.1-1-94 states no requirements for the design of steel components; however, the masonry veneer and shelf angle form a system. Within a system, each element must be compatible with its adjacent element. Because the veneer interacts with the steel shelf angle forming part of the wall system, the shelf angle must satisfy particular needs of the masonry it supports. Masonry design influences the design criteria for the shelf angle with respect to serviceability and durability.
- **Serviceability:**
 - CSA S304.1-1-94 provides many serviceability requirements for masonry that directly affect the design, location and frequency of placement of shelf angles. Consequently, factors governing the design of shelf angles include the following:
 - I. rotation of the shelf angle
 - II. deflection of the shelf angle leg and deflection between anchorages
 - III. deflection of secondary and primary support framing
 - IV. shortening of the building frame
 - V. temperature change and moisture movement within the exterior brick veneer
 - VI. long- and short-term movements
 - The shelf angle must have a rigidity compatible with the stiffness of the masonry it supports (S304.1-1-94 recommends elastic deflection $< L/600$ and long-term deflection $< L/480$).
 - The designer must consider the effects of differential movements; provision for horizontal and vertical movement joints must be carefully considered.
- **Durability:**
 - Requirements are not specifically stated in either the NBCC or S304.1-1-94. However, S304.1 performance requirements demand that the shelf angle and its support framing be durable enough to perform effectively throughout the design service life of the building envelope.
 - Durability largely depends on corrosion protection.
 - CSA A370-94, “Masonry Connectors,” strictly speaking, does not apply to shelf angle design, but in association with the steel design standard, it can be used for guidance for corrosion protection requirements. It recommends that, in buildings in severe weathering regions, a minimum of hot-dipped galvanizing be used. For buildings taller than 11 m (36 ft.) high anywhere in Canada, it is recommended that the shelf angles have a level of corrosion protection at least equivalent to that of hot-dipped galvanizing, regardless of weathering exposure.

- The best way to determine corrosion protection needs is by examining demonstrated effectiveness, that is, history of performance of shelf angles in the area, tempered with an understanding of the reasons for failure.

Construction and Installation

It is good construction practice to place shelf angles within tolerances stated on the drawings, to avoid increasing eccentricities beyond those assumed for strength and serviceability design.

Generally, shelf angles should be provided at a continuous horizontal level around the building perimeter to avoid changes in panel wall stiffness and support stiffness, which make the behaviour of the building system less predictable.

Shelf angles should be continuous at corners to provide continuous support for the masonry.

The horizontal leg of the shelf angle should be installed level or pitched slightly to drain.

A soft movement joint must be provided between the underside of the shelf angle and the top of the masonry veneer below, to prevent the non-load-bearing veneer from becoming a load-bearing element as a result of building movement, a structural engineer must determine the size of the deflection space to take into account the differential movement between floors and expansion of the veneer.

Shimming should be minimized.

Corrosion protection that is damaged by cutting or welding should be repaired.

Bolt holes or slots should not be oversized.

Drilled-in inserts must be installed to a sufficient depth, normal to the wall, with sufficient clearance from discontinuities (appropriate distance from underside of the slab) and with the minimum-maximum specified installation torques.

Comparison of shelf angle details

Detail 1 – Figure 3.4, (p. 3-13)

Advantages

- Connection to the structure is secure.
- There is minimum chance of slipups during construction.
- Minimal site supervision is required.
- Shelf angle bearing against the structure acts as a fire stop.

Disadvantages

- Placement of top course below the shelf angle is difficult.
- Because the location of the shelf angle is fixed after the concrete is cast, adjustments can be made only in brick coursing.
- The angle must be precisely located, both normal to the wall and in elevation. Otherwise, expensive remedial action will be necessary.

Detail 2 – Figure 3.4, (p. 3-13)

Advantages

- Vertical adjustment is possible by adjusting the location of the drilled anchor.
- Limited adjustment, normal to the wall, is possible by means of shims.
- Shelf angle bearing against the structure acts as a fire stop.

Disadvantages

- The location of cast-in anchors could mismatch the holes in the shelf angles.
- New holes must be burned in the shelf angles to correct the above problem. This usually results in insufficient bearing surface for nuts, as well as reduced corrosion protection at site-cut slots.
- This design needs a high degree of site supervision to ensure proper installation. For example, installation of shims has to be supervised to ensure proper placement.
- Placement of shims may destroy the firebreak provided by the shelf angle.

Detail 3 – Figure 3.4, (p. 3-13)

Advantages

- Both vertical and normal adjustment are done easily.
- Insulation is continuous, with less interruption. Thermal bridge is reduced.
- Air barrier is placed with less interruption, which results in a better air barrier joint at the slab block wall interface.

Disadvantages

- In air spaces larger than 25 mm (1 in.), a separate firebreak is required in the cavity at some floors. Verify local building code requirements.

Table 3.4: Movement Joint Spacing

For Concrete Masonry Units (CMUs) 2 N ⁰ 9-Gauge Longitudinal Wires				
Recommended spacing of movement joints	Vertical spacing of joint reinforcement			
	None	600 mm (24 in.)	400 mm (16 in.)	200 mm (8 in.)
Expressed as ratio of panel length to height (<i>L/H</i>)	2	2½	3	4
Panel length not to exceed (regardless of height)	12 000 mm (40 ft.)	13 500 mm (44.3 ft.)	15 000 mm (49.2 ft.)	18 000 mm (59 ft.)

Notes: It is the intention of CSA A165.1 that all types of block may be used indoors.
 Table based on *moisture-controlled* CMU (facet M):
 • For non-moisture-controlled units (facet O), reduce spacings by ½
 • For a solid grouted wall, reduce spacings by ⅓.

For brick veneer movement-joint spacing:

- Rule of thumb for clay-brick facing is to keep the movement-joint spacing 6000–7000 mm (19.7–23 ft.)
- For concrete-brick facing, spacing of movement joints should be approximately 4000 mm (13.12 ft.)

REFERENCE PUBLICATIONS

For more information, consult the following standards:

CSA Standards

CAN3-S304-M84

Masonry Design for Buildings

S304.1-1-94

Masonry Design for Buildings (Limit States Design)

A371-94

Masonry Construction for Buildings

A370-94

Connectors for Masonry

INTRODUCTION

This chapter introduces CAD details that synthesize the information discussed in the previous chapters concerning materials selection and building science and includes checklists for the designer and the builder. The details represent a guide to better practice in brick veneer and CMU backing wall construction. CMHC expects the professional designer to modify the details to accommodate local climate and construction practices; aesthetic, performance and structural criteria; and cost factors. Therefore, CMHC does not guarantee in any way the performance of the walls described. The professional designer must assume all liability in the use and modification of these details.

The first section of this chapter explains some of the important concerns addressed by this wall design. Explanatory notes relating to each detail appear on the facing page for quicker reference. The wall section details are presented from the foundation up, with special details at the end. They cover a variety of window sections and other problematic areas. Every building has its own difficult joint conditions. The designer is advised to pay special attention to drawing these obscure details, as studies have shown that the absence of design details is one of the most common causes of warranty claims. To help the designer, a guide to the use of the guide's CAD CD-Rom is in the appendix.

EXTERIOR WYTHER

The exterior wythe has several functions:

- to provide a traditional and aesthetically pleasing finish
- to serve as a durable, impact-resistant, non-combustible cladding, that helps in two other important ways:
 - to provide protection against weathering, needed to extend the service lives of inner-wall components
 - to offer the first line of defence against the ingress of precipitation

Years ago, standard practice in masonry construction was to build both the CMU structural backing and the exterior brick wythe concurrently. This is not the practice today. The CMU structural backing is completed before, often well before, the laying of the exterior wythe. This facilitates placement of wall components within the cavity and facilitates inspection.

INSULATION

The basic functions of thermal insulation are the following:

- to reduce heat losses, thereby reducing the cost of heating
- to provide a warm surface on the interior side of the wall (thermal comfort)
- to keep the structure warm, thereby minimizing thermal movements
- to keep the vapour barrier warm

In brick veneer/CMU construction, insulation can be placed on the interior face of the backing wall. A better practice, however, is to place it within the cavity, against the exterior face of the concrete masonry wall. This achieves three goals:

- keeping the backing and structural frame warm, thereby minimizing thermal movements
- facilitating continuity of the insulation, thereby reducing the effects of thermal bridges
- taking advantage of the thermal storage capacity of the inner wythe to reduce heating and cooling costs (see discussion in Chapter 1)

The thermal benefits of insulating materials are diminished if the insulation is not in full, intimate contact with the air barrier. If air is allowed to circulate between insulation and the block backing, convection currents are set up, which reduce the effectiveness of insulation. For example, any air between the backing wall and the insulation will be warmed by the warm backing wall. If it can, the warm air will rise, and cold air will come in to take its place, only to be warmed by the backing wall. This way the cycle continues. Laboratory tests have shown that with a gap of 3 mm and severe winter conditions, the effectiveness of insulation may be reduced by 40%.

For the details in this chapter, the sheet membrane adhered to and supported by the concrete masonry backing serves as the air barrier. To receive the full benefit from the insulating materials, the builder should take the following measures:

- ensure that air cannot circulate between the insulation and the membrane
- ensure that the insulation is held securely against the membrane throughout the service life of the wall system.

For those masonry tie systems that inherently provide insulation-restraint mechanisms, standard construction practice is to secure the insulation with the mechanical tie-support system alone. This system has sufficient strength to support and pull compressible insulation into contact with surfaces that are slightly uneven and is sufficiently durable to restrain the insulation throughout the design service life. This system also works better than mechanical fastening by washers over stick clips adhered to the membrane. With either mechanical system, for more rigid insulations, better practice is to provide a perimeter bead of adhesive or a grid of adhesive to compartmentalize air gaps between the back of the insulation and the air barrier. Insulation should never be secured by adhesive alone.

To facilitate placement of insulation in the field, it helps to specify insulations precut to the width of the masonry tie spacing module. This places the cutout for the tie along the perimeter of the insulation, and helps to ease cutting and patching.

The selection of adhesives and fasteners will depend on the rigidity of the insulation, the capabilities and spacing of the tie system, and the irregularities expected along the fastening surface. The following are some further considerations for selection of adhesives and fasteners:

Adhesives

- requirements for clean adhering surfaces
- restrictions on use in wet or cold weather
- chemical compatibility with the insulation and the air barrier
- durability: general stability and long-term effectiveness against the agents and mechanisms of deterioration, such as aging, moisture, attack by microorganisms, temperature and humidity cycles, and repeated movement

Mechanical Fasteners

- creation of thermal bridges
- potential puncturing of air and vapour barriers and their repair
- initial and long-term tensile capacity
- durability: long-term performance against the agents and mechanisms of deterioration, such as moisture and temperature cycles

AIR BARRIER SYSTEM

The necessary characteristics of an effective air barrier were outlined in Chapter 3, “Building Science Concepts.” The role of the air barrier system is to provide a continuous network of durable materials and joints that is virtually airtight and strong and stiff enough to remain airtight and resist deflection when it is exposed to the pressure differences to which it will be subjected. It can be a single material or a combination of materials with the characteristics needed for the desired performance.

Concrete block masonry alone offers minimal resistance to the passage of heat, air, water vapour and water. Masonry in itself is a poor air barrier. Its most important function in the wall assembly, related to the resistance of environmental loads, is to provide stiff, strong, continuous, non-combustible and durable support for the brick facing, insulation, air and vapour seals, and finishes.

Current better practice is to locate the air barrier on the outside face of the concrete block wall where continuity is easier to achieve. The recommended product is a sheet seal membrane. As a strong material, it can bridge the gaps between the structural frame, floor slabs and concrete block. If necessary, the material can be reinforced with a strip of the same material over areas where gaps need to be bridged. The membrane can be folded into openings, such as at doors and windows, and then sealed to the frames. This material can bridge cracks that develop in the masonry and withstand expansion and contraction resulting from aging and changes in temperature and humidity.

Considerations in selection of the air barrier material include the following:

- degree of elasticity needed to accommodate movements in the structure
- adhesive strength and compatibility to bond to the substrate and other assembly surfaces
- cohesive strength to prevent tearing and creeping under air pressure fluctuations, especially where the support is not continuous
- complexity of details for maintaining the air barrier across movement joints and at intersections with other parts of the wall

- access needed for effective inspection and repair during the construction sequence
- dependence on vulnerable elements, such as sealants, located in areas that will be difficult to access later
- sensitivity of the material to climatic conditions and dirt during application
- accessibility for maintenance, if required
- interaction with other components, such as ties, if it has been shown that the air barrier may affect tie performance and that ties can interrupt the continuity of the air barrier

WALL CAVITY

FUNCTION

In the modern brick veneer/CMU exterior wall system, a continuous space known as a *cavity* is maintained between the two masonry wythes. The cavity facilitates the incorporation of non-masonry components, such as insulation and an air/vapour barrier membrane, needed to effectively resist environmental loads imposed on the masonry wall system.

In a rain-screen wall, within the cavity, a continuous *air space* will be maintained between the inner surface of the exterior masonry wythe and the cavity insulation (which is secured to the outer surface of the concrete masonry backing). This air space serves a number of functions:

Environmental Requirements

1. It provides a pathway for any moisture that enters the cavity to drain to the outside of the system by means of weep holes (drainage openings) located at the base of the wall.
2. Along with an effective air barrier system and sufficient venting, the air space provides a chamber to effect pressure equalization or partial pressure equalization across the exterior masonry wythe to help counteract those forces that drive water through the envelope.
3. It provides a space to allow uncontrolled air leakage from the building to readily escape, and therefore serves to minimize the potential for condensation and the adverse effects of condensation on the wall system.
4. It helps dry the wall components by permitting air movement.
5. It serves as a barrier (capillary break) to help retard or prevent the passage of moisture through the wall assembly.

Structural Requirements

6. Where needed structurally, it accommodates differential movement between the wythes caused by moisture and temperature changes.

Construction Requirements

7. It accommodates construction tolerances between masonry-masonry and masonry-structural frames.

To perform the environmental functions effectively, the air space must be kept *reasonably* clear of mortar fins (which bridge the cavity), and from mortar droppings to prevent mortar from providing a path to conduct water across the cavity, and to prevent mortar from blocking the drainage pathways and weep holes at the base of the wall. Indeed, the A371 Standard acknowledges that it is not possible to maintain a totally free air space clear

of mortar fins and mortar droppings. Moreover, the application of an air/vapour barrier membrane to the exterior surface of the CMU backing, a design recommended by this document, provides protection against the ingress of moisture to interior space, and therefore alleviates somewhat the need to provide a completely clear air space. However, the weep holes at the wall base must never be obstructed.

The air space may be kept reasonably clear of mortar fins by bevelling the mortar beds to incline away from the cavity when laying the masonry units. This practice requires very little effort and is very effective in keeping mortar out of the drainage space. Placing wood strips with attached wire pulls to be drawn upward during construction to clean the cavity is often demanded by project specifications, but it is seldom done on the job site. It is impractical because of the interference with its movement offered by the masonry wall ties, and because of variations in the constructed width of the air space resulting from construction tolerances.

A number of options are open to the mason and the designer to help keep the weep holes unobstructed, including: (a) the placement of a coarse gravel drainage layer in the air space at the wall base; (b) the placement of a wire screen in the air space one or two courses above the base flashings; or, (c) the use of proprietary mortar-dropping control devices such as that shown in [Figure 2.12](#), (p. 2-38). When these methods are used, caution in both design and construction must be exercised. Without due care to minimize mortar droppings as the units are laid, these methods encourage the accumulation of mortar droppings higher up the wall, and where the design does not provide for a waterproof membrane to be applied to the backing and where flashing does not extend sufficiently high up the wall, or where the membrane has not been properly placed or sealed, these methods may facilitate the ingress of moisture to interior space. Leaving out masonry units at the wall base to enable clean-out adjacent to weep hole locations, with subsequent placement of these closure units, will ensure that the path of water will not be obstructed.

MINIMUM AIR SPACE

The design width of the air space is that width shown on the construction drawings. When determining this width, the designer should take into careful consideration the function of the air space in the wall assembly with respect to the environmental, structural and construction requirements.

The A371 Standard now provides guidance to the designer for the selection of an appropriate minimum design width of air space. Where an air space is required by the design and the air space serves functions 1 through 5, it is recommended that a design width of not less than 25 mm (1 in.) be selected. Further, with respect to function 5, if the air space is relied on *as the principal means* for providing resistance to the ingress of moisture into interior space, a design width of not less than 40 mm (1.5 in.) should be specified. Thus, where a waterproof membrane is applied to the structural backing, it is reasonable to specify a 25 mm (1 in.) design air space since the air space does not serve as the principal means to prevent the ingress of precipitation, and where a waterproof membrane is not applied, a 40 mm (1.5 in.) design width would be more appropriate.

DESIGN WIDTH AND CONSTRUCTED WIDTH

In addition to environmental considerations, the selection of an appropriate design width must also consider construction tolerances: acknowledged and acceptable deviations of constructed building elements from specified plan, specified elevations and plumb. Because construction tolerances for the masonry and the structural backing are normally accommodated by the air space, *the width of the constructed air space will likely vary from the design width.*

Compatible and achievable construction tolerances for masonry elements are provided in CSA A371. Unfortunately, a review of applicable standards will show that construction tolerances for each building material in the construction industry have been developed independently of one another. The difficulty is that allowable tolerances for structural frames stated in their respective construction standards are greater than acceptable tolerances for claddings such as masonry. This gives rise to interference fits, even where frame and claddings have been erected in accordance with the construction tolerances permitted by their applicable standard. Because this incompatibility has not been appropriately addressed to date by the construction industry, it is clear that the solution for the designer at this time is to:

- take advantage of the existence of an air space in brick veneer/CMU wall assemblies to accommodate the reasonably expected construction tolerances between masonry-masonry and masonry-structural frames; and
- provide design details that readily accommodate these anticipated dimensional variations.

To select an appropriate design width, the designer must integrate these recommendations for minimum design width of air space provided by CSA A371 with the reasonably foreseeable construction tolerances for the building under consideration, to arrive at a suitable, anticipated constructed width of air space. Among many other influencing factors, anticipated deviations across the air space are smaller for low-rise construction than for high-rise, and are smaller for all-masonry structures where the masonry contractor controls placement of both the CMU backing and the exterior masonry wythe.

It is the responsibility of the designer to determine the appropriate design width along with the permissible variation in the constructed width so that the wall system will perform satisfactorily throughout its design service life. These dimensions and tolerances should be communicated to the contractor in the construction documents. Where the designer has failed to specify permissible width variations, a default of ± 13 mm (± 0.5 in.) is used by the A371 Standard, and this value is consistent with the permissible placement tolerances for masonry wall ties (clauses 5.5 and 5.6 of A371).

Also in accordance with the A371 Standard, at any time during the course of construction it is the responsibility of the masonry contractor to notify the designer where the width of the constructed air space does not satisfy the specified permissible design width variations. This will enable the designer to effectively address the issue of tolerances and its impact on the design and performance of the wall system, and to correct this problem.

VAPOUR BARRIER

For best results, a vapour barrier should be complete, but it does not have to be perfectly sealed to function properly. The vapour barrier must be installed in the wall assembly at a location that remains above the dew-point temperature of the indoor air during cold weather. This is generally on the warm side of the insulation.

If the air barrier materials recommended for the wall assembly provide adequate vapour-diffusion control and are located appropriately for a vapour barrier, the air barrier acquires a dual function, as both an air barrier and a vapour barrier.

Some air barrier material cannot be used as vapour barrier (retarder) material, and vice versa. Only if a material has the attributes of both, can it function as both. For example, drywall can function only as an air barrier, and polyethylene can function only as a vapour barrier.

Placing the insulation, air barrier system and vapour barrier within the masonry cavity is very important. Placement here helps ensure that any vapour moving from the interior of the building, either by diffusion or by air leakage, will have either of two outcomes:

- it will readily escape as vapour into the air space and exit the wall system; or
- it will condense and be deposited within the air space, where it may be easily drained from, and not accumulate on or within, other components of the wall system that have less resistance to deterioration by moisture.

Use of the details in this guide greatly helps to prevent the ingress of moisture into interior space.

MASONRY TIES

The requirements for masonry ties in CSA A370 assist greatly in standardizing for the industry acceptable performance levels for the function, durability, strength and serviceability of all masonry ties. Considerable discussion is in Chapter 2. However, no standardized requirements exist for constructability, although constructability is largely a qualitative property that can seriously affect wall component and system performance (structurally and environmentally) and construction costs. The designer selects masonry ties to suit constructability based on experience with and knowledge of masonry construction and sequencing. Tie constructability relates essentially to the following elements:

- ease of placement and simplicity of installation
- susceptibility to placement and installation error
- provision for adjustment
- sequence of installation within the system
- number of components in the tie
- method of attachment of the tie to the backing
- interfacing with other components of the wall system (particularly air and vapour barriers and insulation)
- ease of inspection

Products shown in the details throughout this guide are for illustrative purposes only and are not intended to promote a specific product over others on the market. However, the products that have been used in the illustrations are known to satisfy many of the qualitative properties needed for constructability. For example, products embedded in the structural masonry backing, as opposed to ties that are surface-mounted to the masonry backing, using fasteners, are generally better for both the mason's and the designer's needs for constructability.

RAIN PENETRATION CONTROL

As noted, one of the principal functions of the brick exterior wythe is to provide resistance to the passage of moisture into the wall assembly. To do this, it must be correctly installed:

- forming a good bond between the brick and mortar to resist cracking – CSA A179-94 requires a minimum of 0.2 MPa (30 psi)
- constructing with full head and bed joints, with mortar compacted in a weather-tight joint
- tooling the joints flush and concave or V-shaped to compact the mortar against the units and help close shrinkage cracks while preventing exposure of horizontal surfaces of the brick
- avoiding flush, raked or extruded mortar joints that are either not compacted or catch water running down the wall

To reduce the amount of water leakage into the cavity resulting from pressure differences between it and the exterior, the designer might consider the following requirements for pressure equalization:

- compartmentalizing the cavity with airtight barriers near building corners and at the roof level
- ensuring that the backing wall is stiff and within recommended limits of airtightness to allow pressure equalization to occur with a minimum quantity of air
- venting the cavity via the weep holes (A current CMHC research project is studying the effectiveness of the use of vents along the top of the wall cavity; at present, the research is inconclusive.)

For the pressure-equalized rain-screen wall to fully function, these further conditions should be met:

- The cavity must be designed and constructed in accordance with the recommendations in Chapter 2.
- A device must be used to collect mortar droppings above the weep holes at the bottom of the air space or otherwise, to ensure the weep holes do not become plugged.
- Continuous flashings must be installed at the bottom of the cavity, over shelf angles and all horizontal interruptions in the brick facing to direct water out of the wall through the weep holes. See CMHC's *Best Practice Guide – Flashings* for further information.
- Weep holes must be spaced at 800 mm (32 in.) on centre maximum to provide adequate drainage to direct water to the outside. Minimum area to be provided is 70 mm² (0.11 in.²) for each weep hole.
- Weep holes must extend through the head and bed joint of the bottom course of brick.

DETAIL 4.1a — FOUNDATION/WALL

How It Works

- Moisture in the cavity drains to the bottom of the cavity wall, where it is intercepted by the flashing and directed to the exterior through the weep holes. Rather than extending the flexible flashing, a sheet-metal flashing extends beyond the exterior face of the foundation wall, forming a durable drip edge for water to be shed away from the wall.
- Horizontal joints in the flashings must be lapped and sealed. In addition, the flashings should be sealed to the concrete block and top of the foundation wall. These precautions prevent water from penetrating the building interior along the joint between the concrete block and the foundation wall.
- End dams are required at interruptions in the flashing – such as at door and window openings, changes in the wall assembly or steps in the foundation wall – to prevent water flowing into other assembly components or the building interior.
- Building codes require weep holes to be spaced at a maximum of 800 mm (32 in.) on centre, for adequate cavity drainage. Weep-hole spacing of 600 mm (24 in.) on centre is recommended for better drainage and venting for pressure equalization.
- Weep holes must be kept free of mortar droppings to permit drainage and to vent the air space. Various technologies are available to help prevent plugging of weep holes. See the discussion in Chapter 2.
- The air/vapour barrier membrane shown is a sheet product bonded to the exterior face of the concrete block. There, it is continuous with the foundation wall (itself forming part of the air barrier system) and is fully supported. A continuous and fully supported air barrier are requirements of a pressure-equalized rain screen wall.
- A thermal bridge is created through the foundation wall at the floor slab when the brick veneer is supported by the foundation wall. The thermal bridge could be reduced by insulating the exterior face of the foundation wall. In that case, the insulation must be protected from impact damage. See [Detail 4.1c](#), (p. 4-15) for an alternative that eliminates this thermal bridge.
- Metal flashings provide more effective drip edges than flexible flashings do. However, they are awkward to install as through-wall flashings. Flexible flashings should not be exposed to damaging ultraviolet radiation. Therefore, it is advisable to use a strip of sheet metal to form the drip edge, which is overlapped with a flexible membrane through-wall flashing. Both the sheet-metal and flexible flashings should be fully sealed to their substrates.

Designer Checklist

- A continuous flashing with a drip-edge projection is specified.

Builder Checklist

- Joints in the flashing are lapped at least 100 mm (4 in.), sealed and, in the case of membrane flashings, free of fish mouths.
- Flashings are sealed to the substrate.
- If flexible membrane flashing is used without a metal drip edge, exposed edges are not cut off.
- The installation of flashings, air/vapour barrier membrane and insulation is coordinated with masonry work.
- Before foundation layout is finished, the foundation alignment in the plan and the elevation is coordinated with veneer location and satisfies construction tolerance requirements for CSA masonry and concrete standards.
- Maximum brick corbel is one-third the thickness of the brick.
- Mortar joints are tooled on the exterior side of the brick veneer to provide a concave joint.
- Weep holes extend through the head joint and bed joint.
- Mortar joints are flush on the outside face of concrete block to provide a level surface for installing the air/vapour barrier membrane.
- All penetrations of the air/vapour barrier membrane are sealed.
- The insulation is securely in contact with the back-up wall.
- End dams are provided at changes in the wall assembly and the ends of the flashing are turned up and watertight.
- The air space is reasonably clear of mortar droppings.
- Mechanical fasteners for insulation are installed at minimum spacing of one every 400 mm (16 in.).
- The air/vapour barrier membrane overlaps the through-wall flashing at a minimum of 150 mm (6 in.).

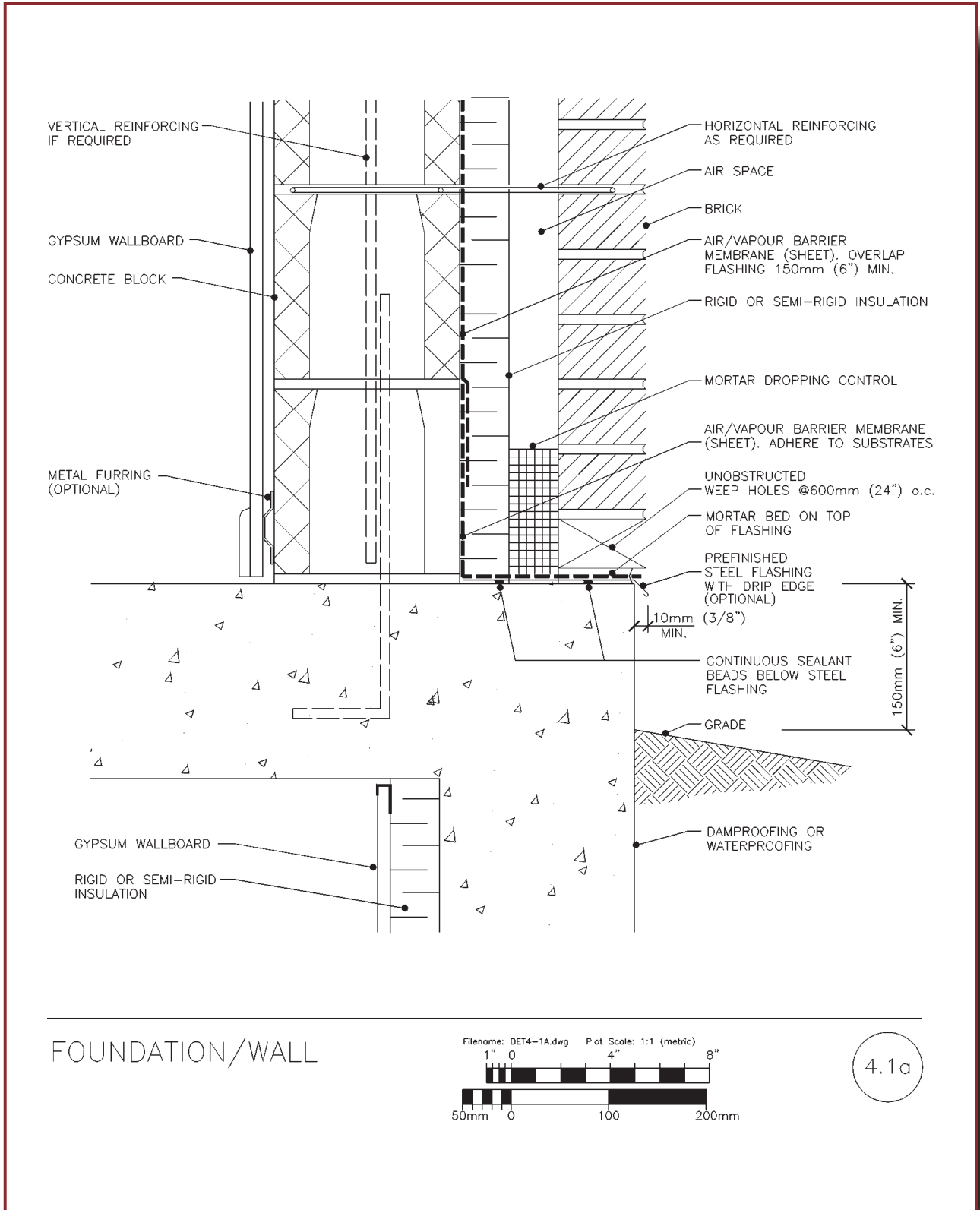

Detail 4.1a: Foundation/Wall

DETAIL 4.1b — ALTERNATIVE FOUNDATION/WALL

How It Works

- The veneer support ledge along the foundation wall improves resistance to water penetration at the floor slab-wall juncture, by moving the bottom of the cavity below the level of the floor slab or top of the foundation wall. The air/vapour barrier membrane provides additional protection at the joint between the wall and the floor slab, as well as superior air/vapour barrier continuity.
- See the detail notes for [Detail 4.1a](#) that also apply to this detail.

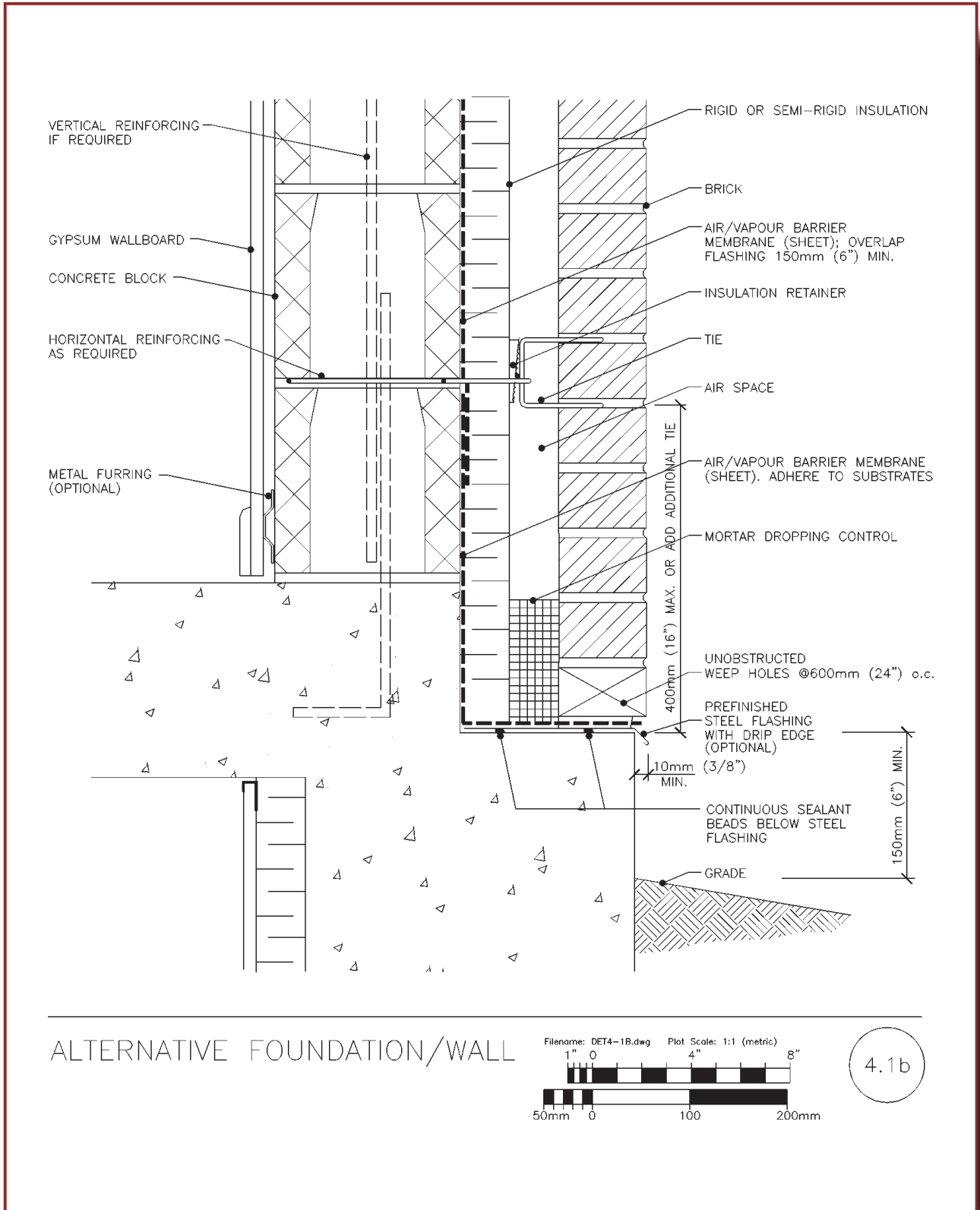

Detail 4.1b: Alternative Foundation/Wall

DETAIL 4.1c — ALTERNATIVE FOUNDATION/WALL

How It Works

- Moisture in the cavity drains to the bottom of the cavity wall, where it is intercepted by the flashing and directed to the exterior through weep holes. Rather than extending the flexible flashing, a sheet-metal flashing extends beyond the edge of the steel angle, forming a durable drip edge for water to be shed away from the wall.
- Horizontal joints in the flashing must be lapped at least 100 mm (4 in.) and sealed. In addition, the flashing should be sealed to its substrates. These precautions prevent water from penetrating the building interior from the flashing joints.
- End dams are required at interruptions in the flashing – such as at door and window openings, changes in the wall assembly or steps in the foundation wall – to prevent water from flowing into other assembly components or the building interior.
- Building codes require weep holes to be spaced at a maximum of 800 mm (32 in.) on centre for adequate cavity drainage. Weep-hole spacing of 600 mm (24 in.) on centre is recommended for both better drainage and venting for pressure equalization.
- Weep holes must be kept free of mortar droppings to permit drainage and to vent the air space. Various techniques are available to help prevent plugging of weep holes. See the discussion in Chapter 2.
- A steel shelf angle connected to the foundation wall with steel brackets supports the brick facing and allows continuous installation of the air/vapour barrier membrane and insulation.
- The air/vapour barrier membrane shown is a sheet product bonded to the exterior face of the concrete block. There, it is continuous with the foundation wall (itself forming part of the air barrier system) and is fully supported. A continuous and fully supported air barrier are requirements of a pressure-equalized rain screen wall.
- In contrast to [details 4.1a](#) and [4.1b](#), the thermal bridge through the top of the foundation wall is completely eliminated. Thermal bridging occurs only through the steel brackets supporting the shelf angle. Maximum continuity is achieved in the insulation, thus reducing heat loss.
- To protect the rigid insulation between the brick veneer and grade that would otherwise be vulnerable to impact damage and deterioration caused by ultraviolet radiation, rigid insulation with a concrete facing is used.
- Metal flashings provide more effective drip edges than flexible flashings do. However, they are awkward to install as through-wall flashings. Flexible flashings should not be exposed to damaging ultraviolet radiation. Therefore, it is advisable to use a strip of sheet metal to form the drip edge, which is overlapped with a flexible membrane through-wall flashing. Both the sheet-metal and flexible flashings should be fully sealed to their substrates.

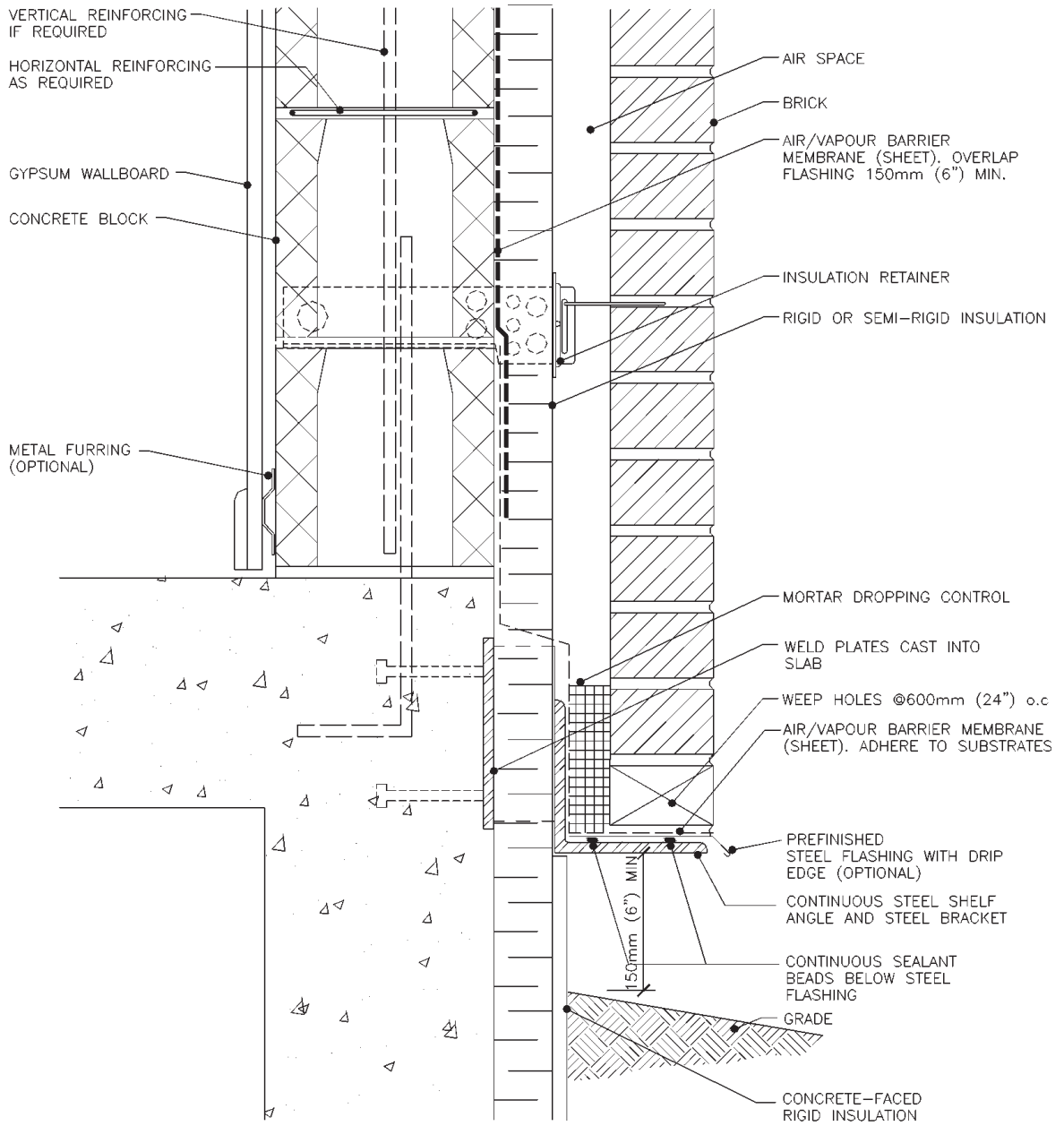

ALTERNATIVE FOUNDATION/WALL

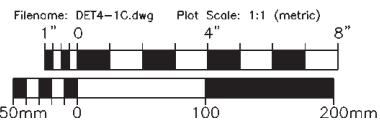

4.1c

Detail 4.1c: Alternative Foundation/Wall

Designer Checklist

- A continuous flashing with a drip-edge projection is specified.
- Weep-hole spacing is specified.
- Building codes have been checked for requirements concerning fire stopping in the cavity.
- The air/vapour barrier and insulation are shown to be continuous.

Builder Checklist

- Joints in the flashing are lapped at least 100 mm (4 in.), sealed and, in the case of membrane flashings, free of fish mouths.
- Flashings are sealed to the substrate.
- If flexible membrane flashing is used without a metal drip edge, the exposed edges are not cut off.
- The installation of flashings, air/vapour barrier membrane and insulation is coordinated with masonry work.
- Before the foundation layout is finalized, the foundation alignment in the plan and the elevation is coordinated with veneer location and satisfies construction tolerance requirements for CSA masonry and concrete standards.
- Maximum brick corbel is one-third the thickness of the brick.
- Mortar joints are tooled on the exterior side of the brick veneer to provide a concave joint.
- Weep holes extend through the head joint and bed joint.
- Mortar joints are flush on the outside face of concrete block to provide a level surface for installing the air/vapour barrier membrane.
- All penetrations of the air/vapour barrier membrane are sealed.
- The insulation is securely in contact with the back-up wall.
- End dams are provided at changes in the wall assembly, and the ends of the flashing are turned up and watertight.
- The air space is reasonably clear of mortar droppings.
- Mechanical fasteners for insulation are installed at minimum spacing of one every 400 mm (16 in.).
- The air/vapour barrier membrane overlaps the through-wall flashing at a minimum of 150 mm (6 in.).
- All anchor points are properly installed along the shelf angle to the slab.
- The shelf angle does not slope toward the building interior.

DETAIL 4.2a — WINDOW SILL (WOOD WINDOW)

How It Works

- The window sill is sloped to drain away from the window opening to prevent accumulation of ice and snow or ponding.
- All non-impervious or jointed sills need continuous waterproof flashings below them to prevent saturation of the brick facing below, which could result in efflorescence and spalling. A precast concrete or stone sill will need a flashing.
- The flashing should extend at least 10 mm (0.4 in.) beyond the brick face to shed water away from the masonry.
- End dams are required in the flashing below the sill to prevent water from spilling into the cavity.
- The air/vapour barrier membrane is continuous with the window assembly to control the infiltration and exfiltration of air around the window opening. The membrane is affixed to the concrete block back-up wall and returned into the window opening. An air seal between the window frame and the wall is provided by injecting single-component polyurethane foam, as shown.
- Recommended sill materials include precast concrete, stone or sheet-metal flashing. Brick sills perform poorly because of the spalling caused by moisture penetration during freeze-thaw cycles.
- Sealant around the exterior perimeter of the window frame provides a weather seal, preventing water from penetrating the wall cavity.
- End dams are recommended in the sill at the jambs to protect adjacent bricks from saturation and leaks into the wall assembly.
- Metal flashings provide more effective drip edges than flexible flashings. Membrane flashings are susceptible to deterioration from exposure to ultraviolet radiation. Furthermore, they require support under horizontal sections.

Designer Checklist

- A 1:10 slope on the sill is specified to promote good drainage.
- Flashings are specified under all non-impervious and jointed sills.
- Flashing materials are specified to be continuous across the opening, without joints.
- End dams are specified at flashing terminations.
- The window frame and brick overlap enough for the sealant to be applied properly.
- A continuous drip-edge projection is specified on flashings.
- The air/vapour barrier is carefully detailed to be continuous with the window, and coordinated with the specification sections for the window, masonry and air/vapour barrier membrane.
- Upturns or lugs at the ends of the sill are specified (or at least a sealed joint tooled) to direct water away from the brick.
- A filled or solid concrete block at the sill of the window opening is specified to provide horizontal support for the wood blocking.

Builder Checklist

- The installation of flashing, air/vapour barrier membrane and window is coordinated with masonry work.
- Joints are not used in the flashing.
 - Unavoidable joints in large openings are lapped at least 100 mm (4 in.) and sealed.
- The sill is sloped to drain away from the window.
- The flashing is extended beyond the exterior face of the wall below to form a drip.
- End dams are provided on the flashing.

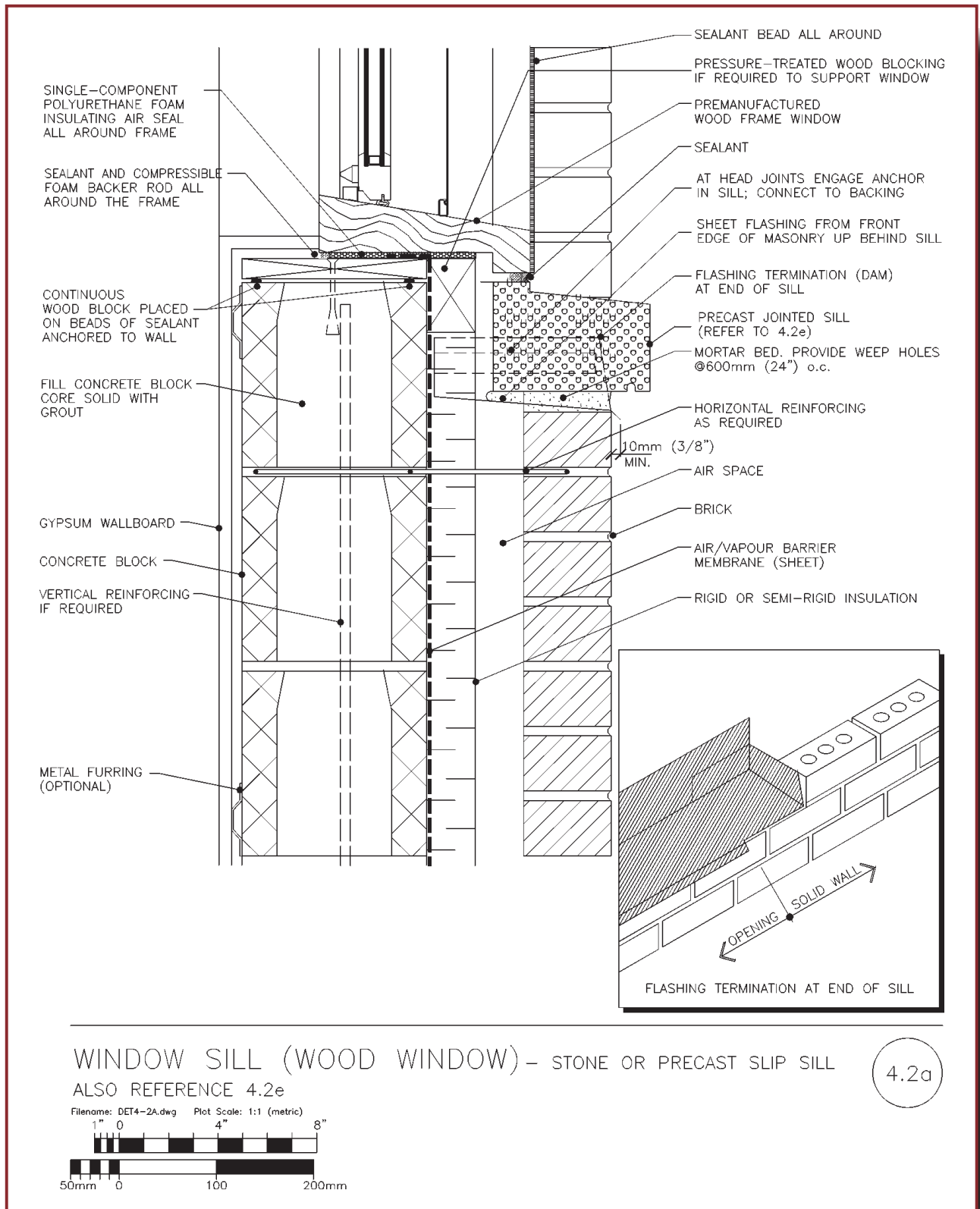

WINDOW SILL (WOOD WINDOW) – STONE OR PRECAST SLIP SILL

4.2a

ALSO REFERENCE 4.2e

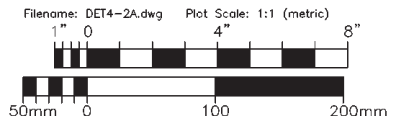

Detail 4.2a: Window Sill (Wood Window)

DETAIL 4.2b — WINDOW SILL (ALUMINUM WINDOW)

How It Works

- The window sill is sloped to drain away from the window opening to prevent accumulation of ice and snow or ponding.
- A continuous extruded aluminum sill, impervious to moisture penetration, protects the brick veneer below it from efflorescence and spalling.
- A drip edge extends 25 mm (1 in.) beyond the brick face to shed water away from the wall below.
- The air/vapour barrier membrane is continuous with the window assembly to control the infiltration and exfiltration of air around the window opening. The membrane is affixed to the concrete block back-up wall and returned into the window opening. An air seal between the window frame and the wall is provided by injecting single-component polyurethane foam, as shown.
- Sealant around the exterior perimeter of the window frame provides a weather seal, preventing water from penetrating the wall cavity.
- Sealant at the joint between the ends of the sill and the brick at the jambs prevents moisture penetration into the wall assembly and the adjacent brick.

Designer Checklist

- A slope on the sill is specified to promote good drainage.
- A continuous extruded aluminum sill without joints is specified.
- A continuous drip-edge projection is specified on the sill at least 25 mm (1 in.) from the face of the masonry veneer.
- The window frame and brick overlap enough for the sealant to be applied properly.
- The air/vapour barrier is carefully detailed to be continuous with the window and is coordinated with specification sections for the window, masonry and air/vapour barrier membrane.
- Rain deflectors are specified at the jambs of the sill, complete with sealants.
- Non-corroding and compatible materials are specified, and dissimilar metals and aluminum do not come in contact with mortar.
 - A bituminous coating or an impervious flexible membrane is installed underneath the sill.
- A filled or solid concrete block at the sill of the window opening is specified.

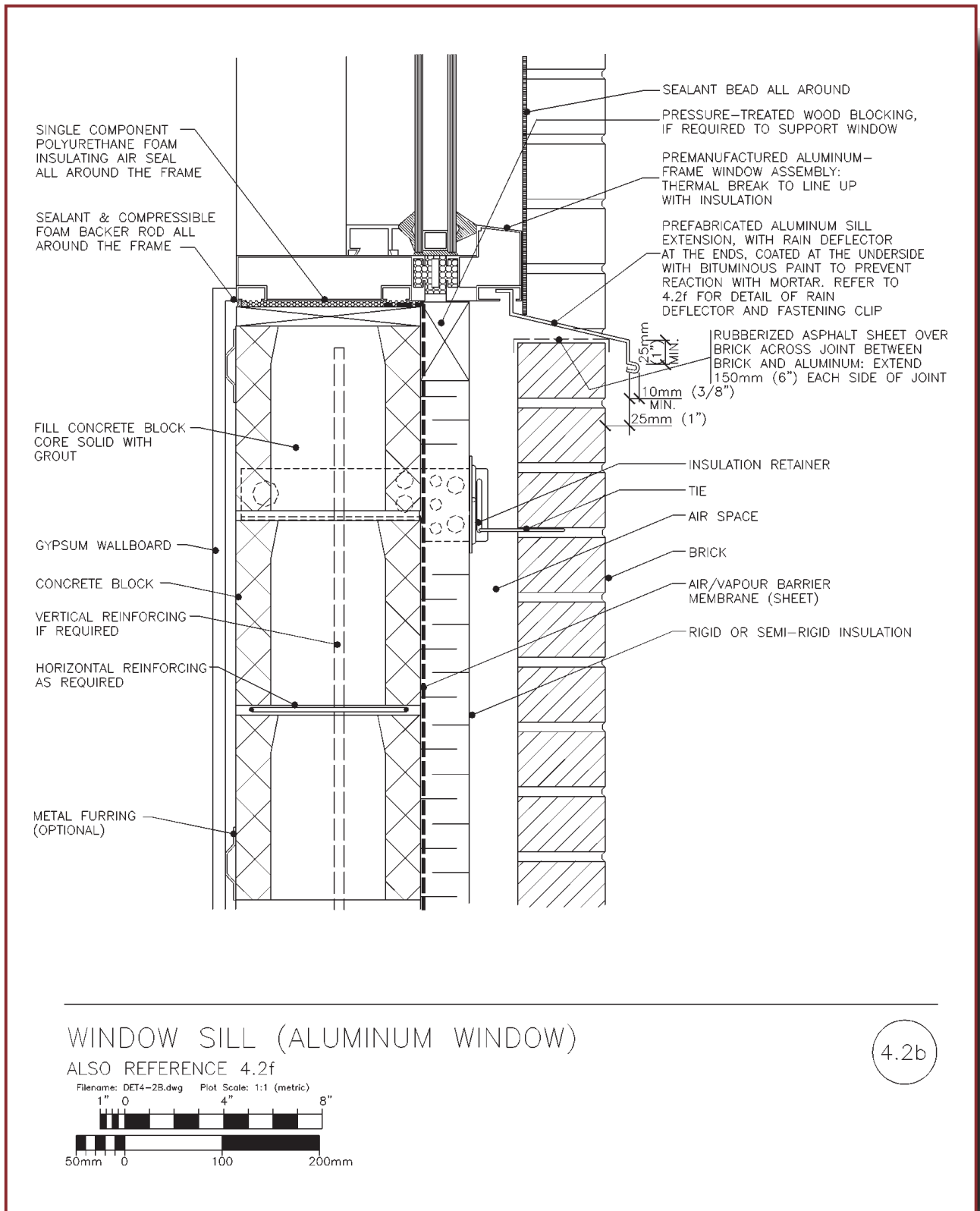

Detail 4.2b: Window Sill (Aluminum Window)

Builder Checklist

- The installation of the air/vapour barrier membrane and window is coordinated with masonry work.
- Joints are not used in the sill.
- The sill is sloped to drain away from the window.
- The aluminum sill is not in direct contact with mortar unless the sill has been protected with a bituminous coating or an impervious flexible membrane.
- The sill is extended at least 25 mm (1 in.) beyond the face of the wall to form a drip.
- The sealant at the ends of the sill at the window jambs is tooled to direct water away from the adjacent brick.

DETAIL 4.2c — WINDOW HEAD

How It Works

- Moisture in the cavity is intercepted by the through-wall flashing over the lintel and is directed to the exterior through weep holes. A sheet-metal flashing extends beyond the plane of the wall, forming a drip edge that sheds water away from the window opening.
- End dams are required in the flashing at the jambs of the wall opening, to prevent water from flowing into the adjacent wall assembly.
- The air/vapour barrier membrane is continuous with the window assembly to control the infiltration and exfiltration of air around the window opening. The membrane is affixed to the concrete block back-up wall and returned into the window opening. An air seal between the window frame and the wall is provided by injecting single-component polyurethane foam, as shown.
- Sealant around the exterior perimeter of the window frame provides a weather seal, preventing water from penetrating the wall cavity.
- Where horizontal joints in the flashings are unavoidable, they are lapped and sealed. In addition, the flashings should be sealed to the lintel. These precautions prevent water from penetrating other building components from the ends of the angle.
- Metal flashings provide more effective drip edges than flexible flashings do. However, they are awkward to install as through-wall flashings. Flexible flashings should not be exposed to damaging ultraviolet radiation. Therefore, it is advisable to use a strip of sheet metal to form the drip edge, which is overlapped with a flexible membrane through-wall flashing. Both the sheet-metal and flexible flashings should be fully sealed to their substrates.

Designer Checklist

- A continuous flashing with a drip-edge projection is specified.
- The air/vapour barrier is carefully detailed to be continuous with the window and coordinated with the specification sections for the window and masonry work.

Builder Checklist

- Joints are not used in the flashing.
 - Unavoidable joints in the flashing are lapped at least 100 mm (4 in.), sealed and, in the case of membrane flashings, free of fish mouths.
- Flashings are sealed to the substrates.
- If flexible membrane flashing is used without a metal drip edge, the exposed edges are not cut off.
- The flashing extends at least 10 mm (0.4 in.) beyond the exterior face of the wall, forming a drip.
- The installation of flashing, air/vapour barrier membrane and insulation is coordinated with masonry work.
- The installation of air/vapour barrier is coordinated with window installation.
- End dams are provided in the flashings over the window jambs.

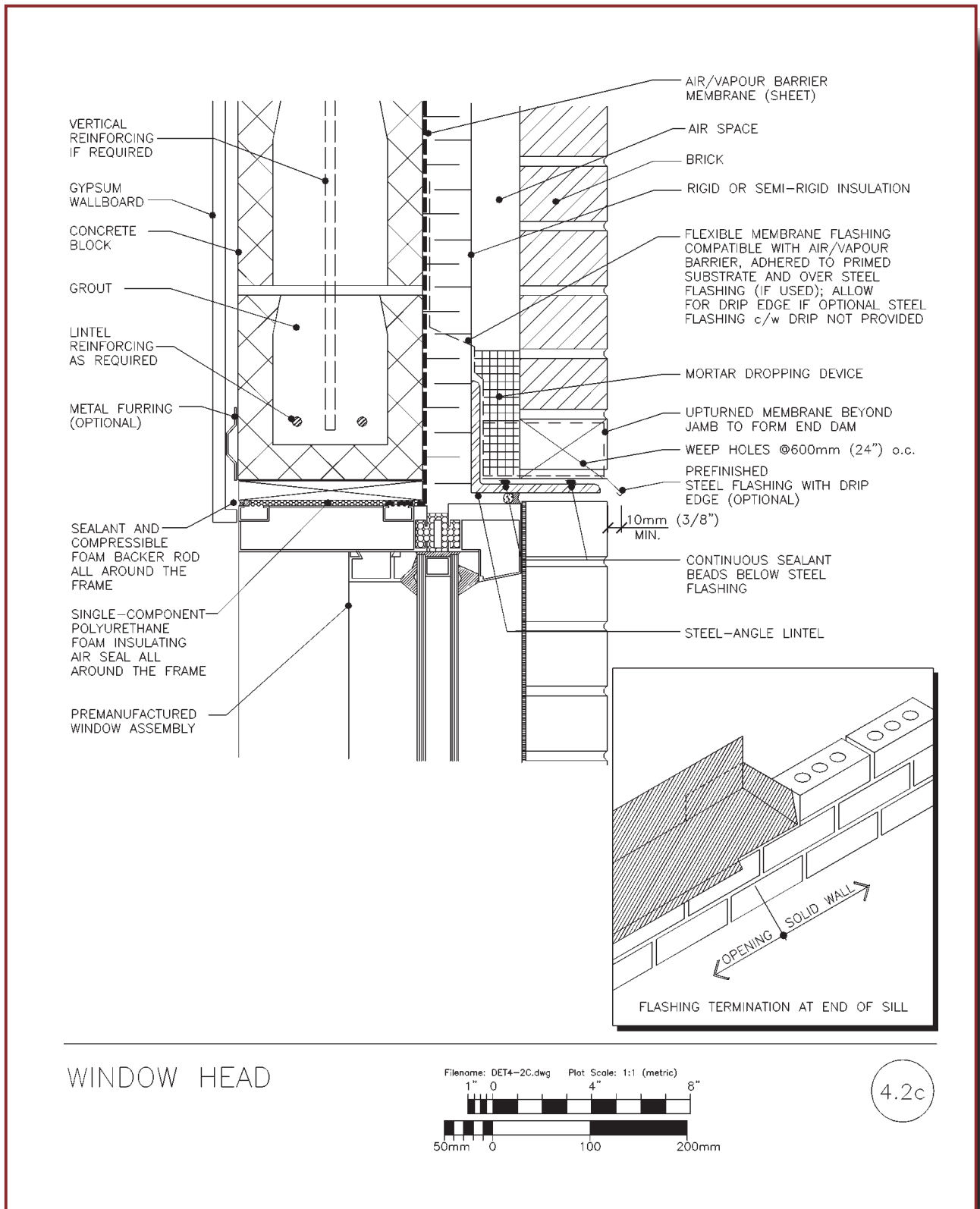

WINDOW HEAD

Detail 4.2c: Window Head

DETAIL 4.2d — WINDOW JAMB

How It Works

- The air/vapour barrier membrane is continuous with the window assembly to control the infiltration and exfiltration of air around the window opening. The membrane is affixed to the concrete block back-up wall and returned into the window opening. An air seal between window and wall is provided by injecting single-component polyurethane foam, as shown.
- Sealant around the exterior perimeter of the window frame provides a weather seal, preventing water from penetrating the wall cavity.
- The window is positioned in the wall assembly to keep the outer pane of glass either in line with the insulation or further toward the building interior. If there is a thermal break in the window, it must be aligned with the insulation. Most window assemblies are not wide enough to cover the cavity; therefore, either a brick return at the jambs or a jamb extension is required, depending on the width of the cavity.

Designer Checklist

- The air/vapour barrier is carefully detailed to be continuous with the window and coordinated with the specification sections for the window and masonry work.
- The window is positioned to keep the glazing in line with the insulation or further toward the interior of the window opening.
 - For windows with thermal breaks, the thermal break is aligned with the wall insulation.
- Where the window position makes it necessary, brick returns at the window jambs are detailed to close the wall cavity or provide a jamb extension to allow the sealant to be applied properly.

Builder Checklist

- The installation of the air/vapour barrier membrane is coordinated with masonry work and window installation.

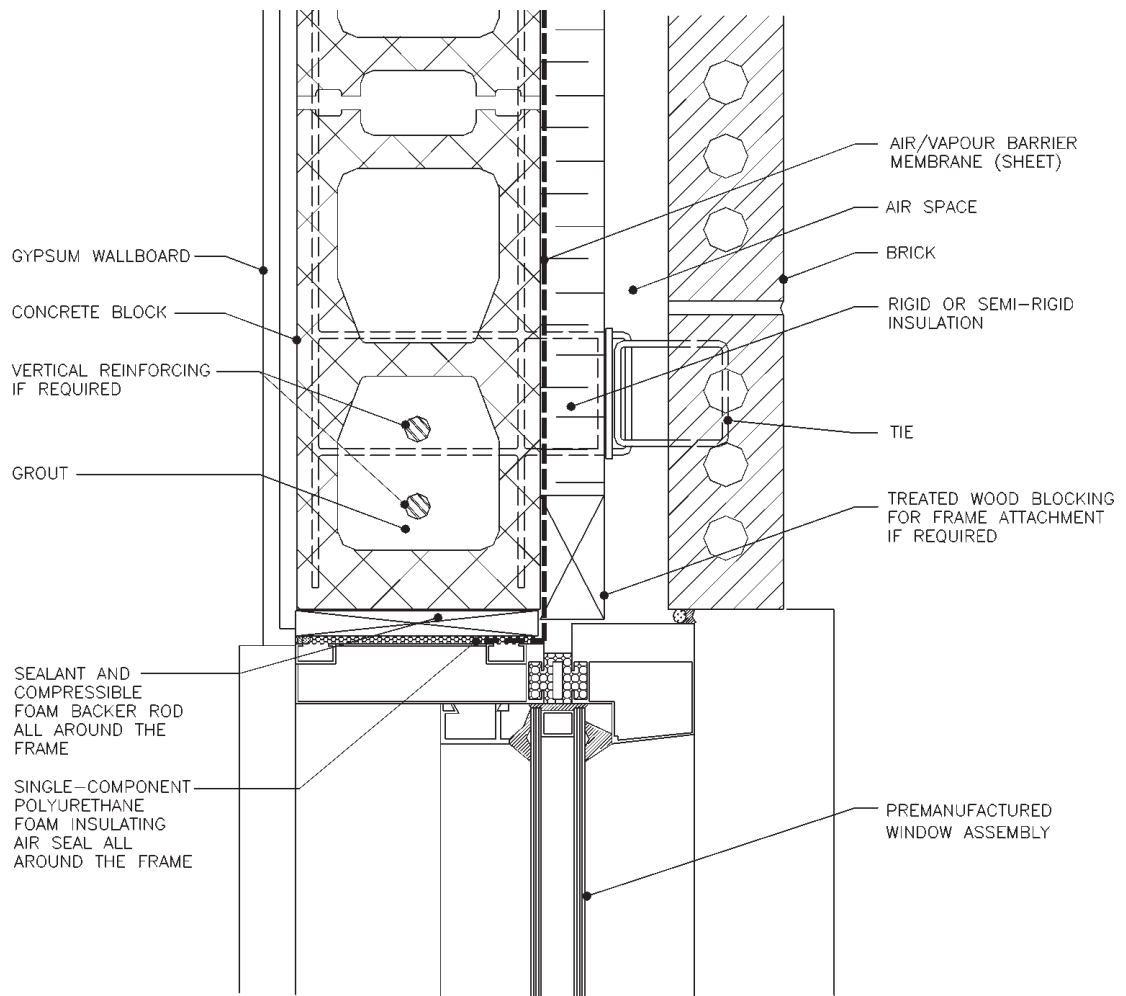

WINDOW JAMB

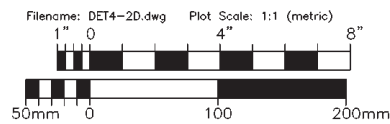

4.2d

Detail 4.2d: Window Jamb

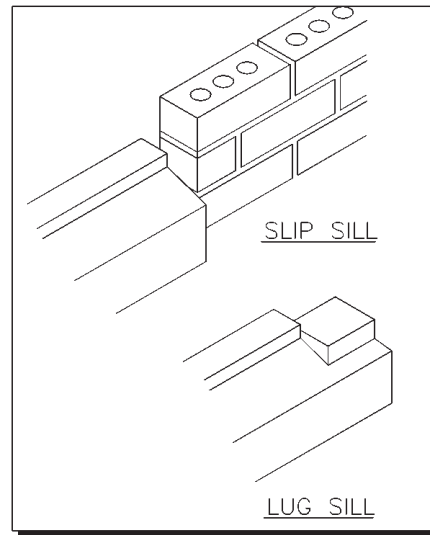
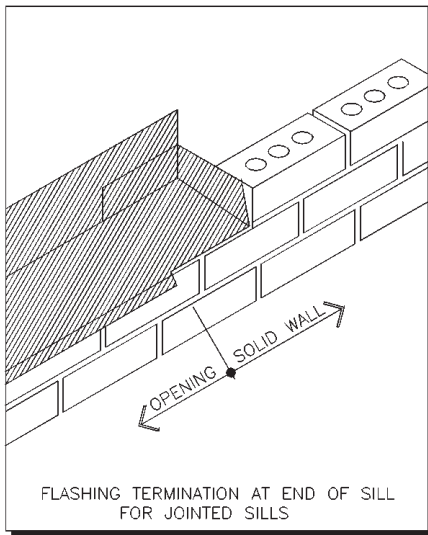
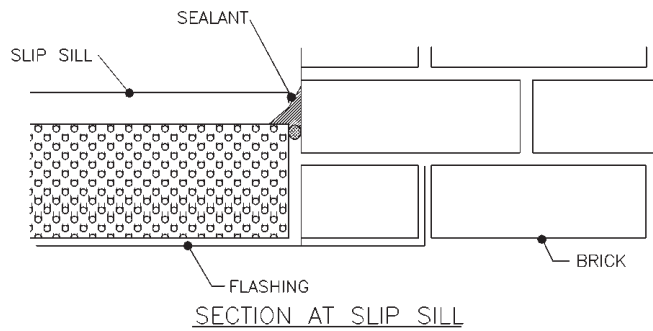
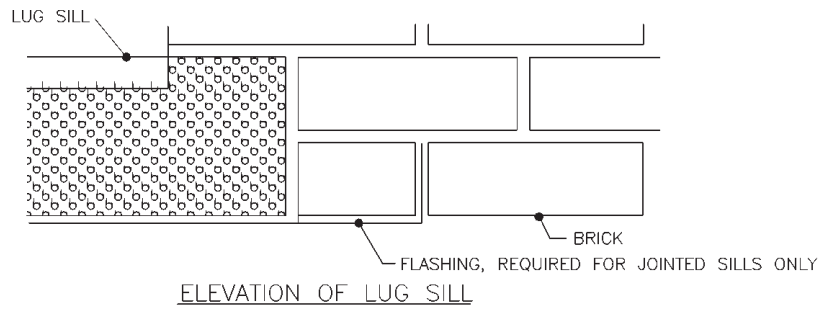

FLASHING/SILL TYPES

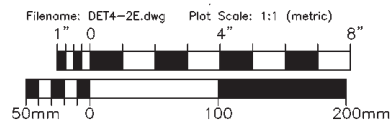

4.2e

Detail 4.2e: Flashing/Sill Types

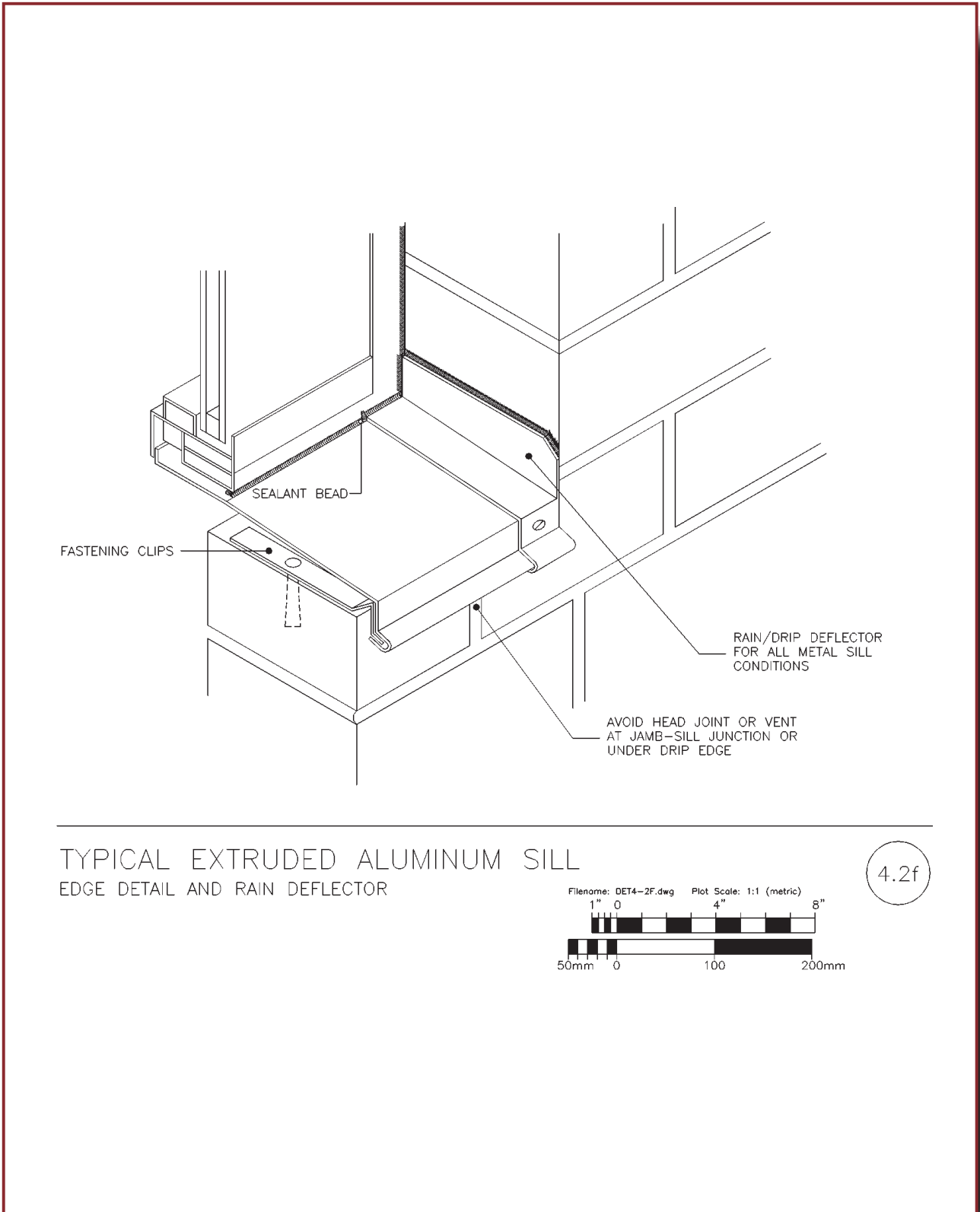

Detail 4.2f: Typical Extruded Aluminum Sill

DETAIL 4.3a — SLAB/WALL

How It Works

- Moisture is drained toward the bottom of the wall within the cavity, where it is intercepted by the flashing over the shelf angle and directed to the exterior through weep holes. A sheet-metal flashing extends beyond the exterior face of the brick veneer, forming a drip edge for water to be shed away from the brick face below and the exposed top edge of the brick course immediately below the shelf angle.
- The insulation is located on the outside face of the block to maintain continuity and minimize heat loss at the slab edge. A thermal bridge is unavoidable at the bent steel plate supporting the brick veneer. However, the losses at this point may be beneficial. In winter, the angle stays warm, preventing ice build-up at the bottom of the cavity, thereby aiding drainage through the weep holes. Also, the steel is not subjected to the effects of a wide temperature differential, causing seasonal expansion and contraction; thus, thermal movement is minimized.
- The bent steel plate and metal flashing together provide a continuous horizontal barrier across the cavity for the compartmentalization required for a pressure-equalized cavity wall. They also provide fire stopping, which may be required by building codes.
- Weep holes must be kept free of mortar droppings to permit drainage and to vent the air space. Various technologies are available to help prevent plugging of weep holes. See the discussion in Chapter 2.
- Building codes require weep holes to be spaced at a maximum of 800 mm (32 in.) on centre for adequate cavity drainage. A spacing of 600 mm (24 in.) on centre maximum is recommended for better drainage and venting for pressure equalization.
- The effectiveness of the use of vent openings along the top of the wall cavity is not yet fully established. A CMHC research project is under way.
- A compressible joint is required at the top of the brick veneer and non-load-bearing concrete block at the underside of the bent steel plate and concrete slab, to allow for deflection, frame shortening and volume changes in the brick and block. A gap is also required between the top of the insulation and underside of the bent steel plate to prevent damage to the insulation or its delamination as a result of structural movement. A compressible joint is also desirable at the top of the gypsum wall board and the underside of the slab, to allow for movement.
- The joint between the underside of the angle and top of the brick must be sealed to prevent rain from penetrating the cavity and excessively wetting the top course of brick.
- The joint between the underside of the slab and top of the block is sealed at the outside edge to make the joint airtight and to make the air/vapour barrier continuous. The rest of the joint is filled with compressible insulation to reduce heat loss through this part of the wall. Some fire stopping may be required in the cavity.
- Horizontal joints in the flashings must be lapped at least 100 mm (4 in.), and sealed to guard against moisture penetration at the joints.
- The discontinuous steel channel clips secured to the underside of the slab over the concrete block wall provide lateral support for the wall. Other methods are commonly used at the discretion of the designer, as specified by the structural engineer.

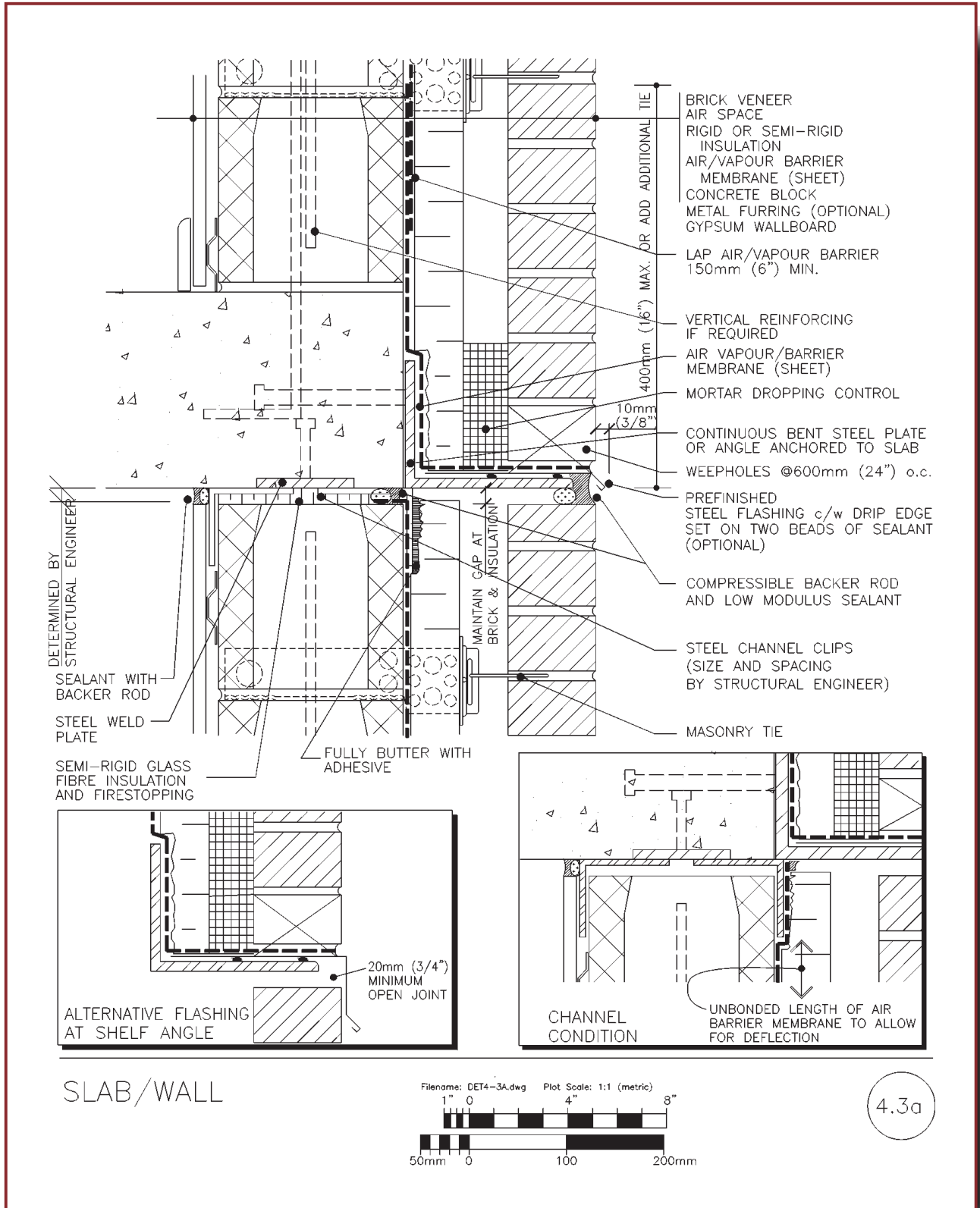

Detail 4.3a: Slab/Wall

- Bent steel plates cast into the slab are preferable to adjustable shelf angles bolted to cast-in or drilled-in anchors. Often the cast-in bolt locations do not line up with the corresponding shelf angle slots. Enlarging the slot in the steel angle on site destroys corrosion protection, requiring touch-up paint that may be less effective than factory-applied protection. The enlarged slot may have an insufficient bearing surface for the nut and washer. Greater care in construction and more rigorous inspection are required to ensure the angles are properly aligned, the shim plates are used correctly and the connection is properly torqued. Furthermore, the anchor bolts decrease the clear air space in the area most critical to proper drainage. The reduced cavity width increases the tendency for the cavity to become filled and blocked with mortar droppings. Also, the bolts tend to puncture the air/vapour barrier membrane and through-wall flashing.

Designer Checklist

- The structural engineer sized the shelf angle and the minimum movement joint sizes, both under the shelf angle and under the slab.
- The dimension for the joint under the slab includes an allowance for the thickness of steel channel clips and fully compressed insulation.
- The non-load-bearing concrete block wall is supported laterally.
- Fire stopping at the slab meets building code requirements.
- Corrosion protection is in place for the shelf angle and steel flashing.
- The air/vapour barrier and insulation are carefully detailed to be continuous.
- The weep-hole spacing is provided.
- The movement joint is detailed to be free of mortar.
 - The size of the joint is compatible with the type of sealant specified.
 - Allowances are indicated for movement where the air/vapour barrier membrane is affixed to the channel clips.
- A sheet-steel flashing is shown with a drip edge extending beyond the face of the brick veneer.
 - Non-typical flashing details are drawn.

Builder Checklist

- The installation of flashings, air/vapour barrier and insulation is coordinated with masonry work.
- The joints between the top of the brick and underside of the angle, and the top of the block and underside of the slab are free of mortar and are the specified size.
- The gap *below* the metal drip and above the brick is filled with sealant.
- The flexible through-wall flashing is projecting beyond the mortar joint and affixed to the metal flashing with a drip edge.
 - The flexible flashing has not been cut back to the mortar joint.
- Maximum brick corbel is one-third the thickness of the brick. (Check location of shelf angle.)
- Weep holes and air spaces are reasonably clear of mortar droppings.
- Weep holes extend through the head joint and bed joint.
- Flashings are continuous (especially at corners) and installed with lap joints of 100 mm (4 in.) minimum.
- The air/vapour barrier membrane laps over the through-wall flashing at least 150 mm (6 in.).

- ❑ The angle is installed continuously around the building perimeter, including corners, and the joints are mitred.
- ❑ All anchor points of the shelf angle to the slab are properly installed.
- ❑ The shelf angle does not slope toward the building interior.
- ❑ The insulation is securely in contact with the back-up wall and adheres fully or has a full perimeter adhesive bead.
- ❑ The edge of the brick below the shelf angle is not exposed, with sealant in the joint to cover the brick or the metal flashing extended to cover the brick face.

DETAIL 4.3b — ALTERNATIVE SLAB/WALL

How It Works

- Moisture is drained toward the bottom of the wall within the cavity, where it is intercepted by the flashing over the shelf angle and directed to the exterior through weep holes. A sheet-metal flashing extends beyond the exterior face of the brick veneer, forming a drip edge for water to be shed away from the brick face below and the exposed top edge of the brick course immediately below the shelf angle.
- The insulation is located on the outside face of the block to maintain continuity and minimize heat loss at the slab edge. Thermal bridging is less than in [Detail 4.3a](#) – only the supports for the shelf angle interrupt the insulation.
- Building codes require weep holes to be spaced at a maximum of 800 mm (32 in.) on centre for adequate cavity drainage. A maximum spacing of 600 mm (24 in.) on centre is recommended for better drainage and venting for pressure equalization.
- The effectiveness of the use of vent openings along the top of the wall cavity is not yet fully established. A CMHC research project is under way.
- Weep holes must be kept free of mortar droppings to permit drainage and to vent the air space. Various technologies are available to help prevent plugging of weep holes. See the discussion in Chapter 2.
- A compressible joint is required at the top of the brick veneer and non-load-bearing concrete block at the underside of the bent steel plate and concrete slab to allow for deflection, frame shortening and volume changes in the brick and block. A gap is also required between the top of the insulation and underside of the bent steel plate to prevent damage to the insulation or its delamination as a result of structural movement. A compressible joint is also desirable at the top of the gypsum wall board and the underside of the slab to allow for movement.
- The joint between the underside of the metal flashing and the top of the brick must be sealed to prevent rain from penetrating the cavity and excessively wetting the top course of brick.
- The air/vapour barrier membrane is continuous over the joint between the underside of the slab and the top of the block to make the joint airtight. The unbonded length of air barrier membrane allows deflection of the slab to take place without affecting the integrity of the air barrier.
- The movement joint over the concrete block wall is filled with compressible insulation to reduce heat loss through this part of the wall. Some fire stopping may be required.
- Horizontal joints in the flashings must be lapped at least 100 mm (4 in.) and sealed to guard against moisture penetration at the joints.
- The discontinuous steel channel clips secured to the underside of the slab over the concrete block wall provide lateral support for the wall. Other methods are commonly used at the discretion of the designer, as specified by the structural engineer.

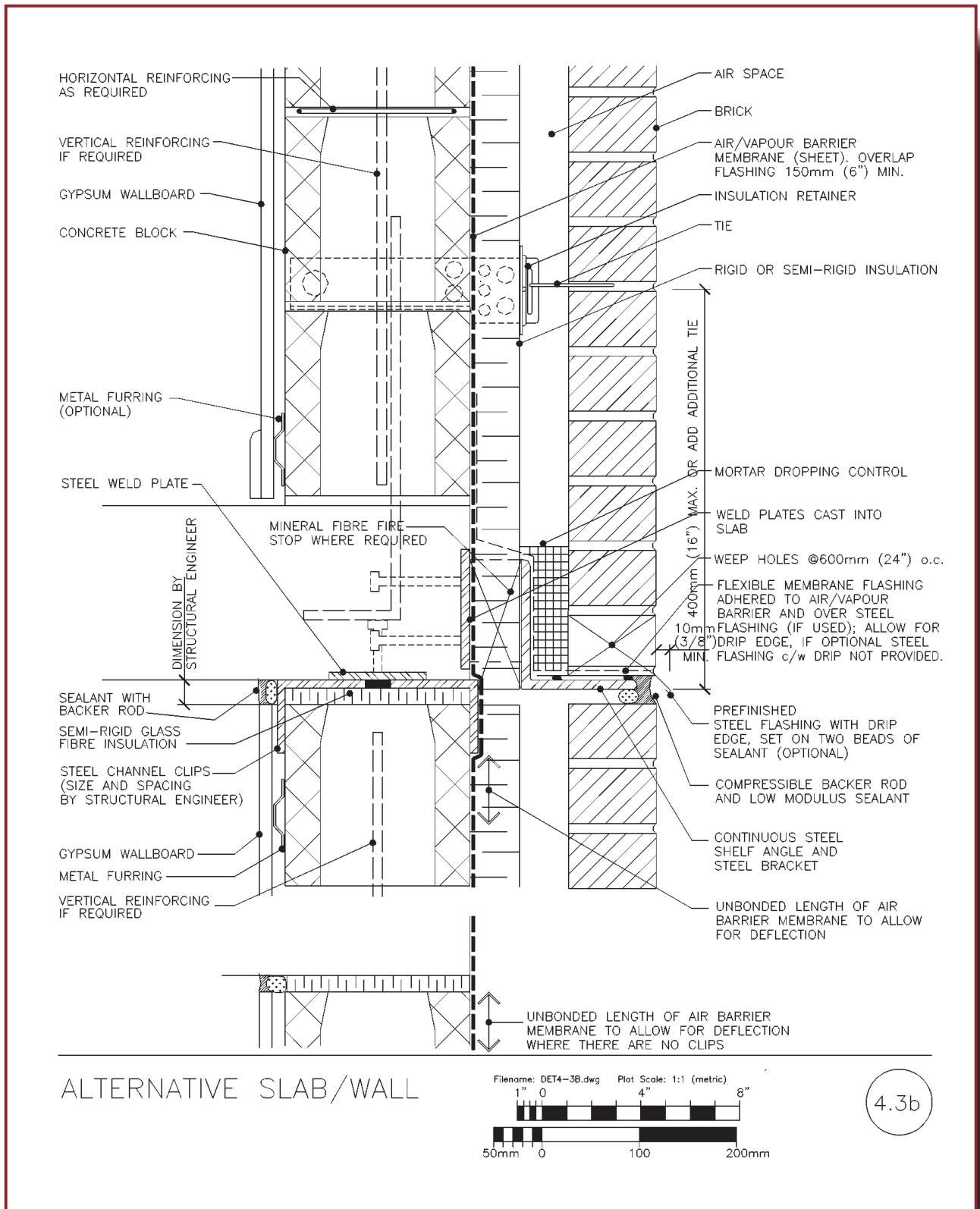

Detail 4.3b: Alternative Slab/Wall

- [Detail 4.3b](#) is preferable to [Detail 4.3a](#) for thermal performance. A disadvantage of using a shelf angle supported by brackets from the slab over an angle cast into the slab is the loss of compartmentalization of the cavity and the need to provide fire stopping, if required; an airtight barrier for either of these purposes may not be required at each floor slab, however. The advantage of using the shelf angle supported by brackets from the slab is the improved continuity of both the insulation and air/vapour barrier membrane and vertical- and normal-to-wall adjustment.

Designer Checklist

- The structural engineer has sized the shelf angle and the minimum movement joint sizes, both under the shelf angle and under the slab.
- The dimension for the joint under the slab includes allowances for the thickness of steel-channel clips and fully compressed insulation.
- The non-load-bearing concrete block wall is supported laterally.
- Corrosion protection is ensured for the shelf angle and steel flashing.
- Weep-hole spacing is provided.
- The movement joint is detailed to be free of mortar.
 - The size of the joint is compatible with the type of sealant specified.
 - Allowances are indicated for movement where the air/vapour barrier membrane is adhered to the channel clips.
- A sheet-steel flashing is shown with a drip edge extending beyond the face of the brick veneer.
 - Atypical flashing details are drawn.

Builder Checklist

- The installation of flashings, air/vapour barrier and insulation is coordinated with the masonry work.
- The joints between the top of the brick and underside of the angle, and the top of the block and underside of the slab are free of mortar and are the specified size.
- The gap *below* the metal drip and above the brick is filled with sealant.
- The flexible through-wall flashing is projecting beyond the mortar joint and affixed to the metal flashing with a drip edge.
 - The flexible flashing is not cut back to the mortar joint.
- Maximum brick projection is one-third the thickness of the brick. (Check location of shelf angle.)
- Weep holes and air spaces are clear of mortar droppings.
- Weep holes extend through the head joint and bed joint.
- Flashings are continuous (especially at corners) and installed with lap joints of at least 100 mm (4 in.).
- The air/vapour barrier membrane laps over the through-wall flashing at least 150 mm (6 in.).
- The angle is installed continuously around the building perimeter, including corners, and the joints are mitred.
- All anchor points of the shelf angle to the slab are properly installed.
- The shelf angle does not slope toward the building interior.
- The insulation is securely in contact with the back-up wall.
- All penetrations through the air/vapour barrier membrane are sealed.
- End dams are provided at all openings or abutments in the cavity.

DETAIL 4.4 — PATIO DOOR/BALCONY

How It Works

- Premanufactured metal door sills are designed to withstand weather and provide safe support for foot traffic. The sill is sloped to direct moisture away from the door.
- The door frame is supported on a raised cast-in-place concrete curb or solid masonry to control water penetration along the slab from the balcony to the interior. For the same reason, the balcony slab is sloped to drain away from the door.
- The air/vapour barrier is continuous with the door assembly to control the infiltration and exfiltration of air around the door opening. The membrane is affixed to the concrete block and returns into the door opening, where it is lapped onto the door frame and sealed.
- An impervious membrane is installed below the door frame from the exterior face of the concrete curb to the inside face of the door frame, where it is turned up. The membrane acts as a secondary flashing to intercept possible water leakage through the sill of the door frame. If the extruded sill is aluminum, the membrane also prevents contact between the concrete and the aluminum, which will otherwise deteriorate.
- A compressible joint is required at the top of the brick veneer and non-load-bearing concrete block at the underside of the concrete slab to allow for deflection, frame shortening and volume changes in brick and block. A gap is also required between the top of the insulation and underside of the concrete slab to prevent damage to the insulation or its delamination as a result of structural movement. A compressible joint is also desirable at the top of the gypsum wall board to allow movement.
- The sill protects the membrane flashing from damage resulting from foot traffic and ultraviolet radiation.
- The sealant at the joint between the ends of the sill and the brick at the jambs prevents moisture from penetrating the wall assembly and the adjacent brick.
- The joint between the sill and the door is sealed to prevent water penetration.
- See “How It Works” for [Detail 4.3a](#), (p. 4-31), which also applies to this detail.

Designer Checklist

- A slope on the sill and the balcony slab is specified to promote good drainage.
- Sill and flashing materials are specified to be continuous across the opening, without joints.
- The air/vapour barrier membrane is carefully detailed to be made continuous with the patio door and coordinated with the specification sections for the window and masonry work.
- Caulking at the jambs of the sill is specified to prevent water from penetrating the wall assembly and excessively wetting the adjacent brick.

- Non-corroding and compatible materials are specified for flashings and other components, and dissimilar metals do not come in contact.
 - If an aluminum sill is used to match the door frame, the underside of the sill is prevented from contacting the concrete via the membrane flashing.
- A filled or solid concrete block is specified at the sill of the window opening to provide horizontal support for the air/vapour barrier membrane.
- The thermal break in the patio door is aligned with the wall insulation to ensure that the interior section of the frame is on the warm side of the assembly.

Builder Checklist

- The installation of the air/vapour barrier membrane and window is coordinated with the masonry work.
- Joints are not used in the sill and flashing.
- The sill and balcony are sloped to drain away from the patio door.
- The aluminum sill is not in direct contact with the curb.
- The caulking at the ends of the sill at the door jambs is tooled to direct water away from the adjacent brick.
- The ends of the flashing are turned up to form dams.

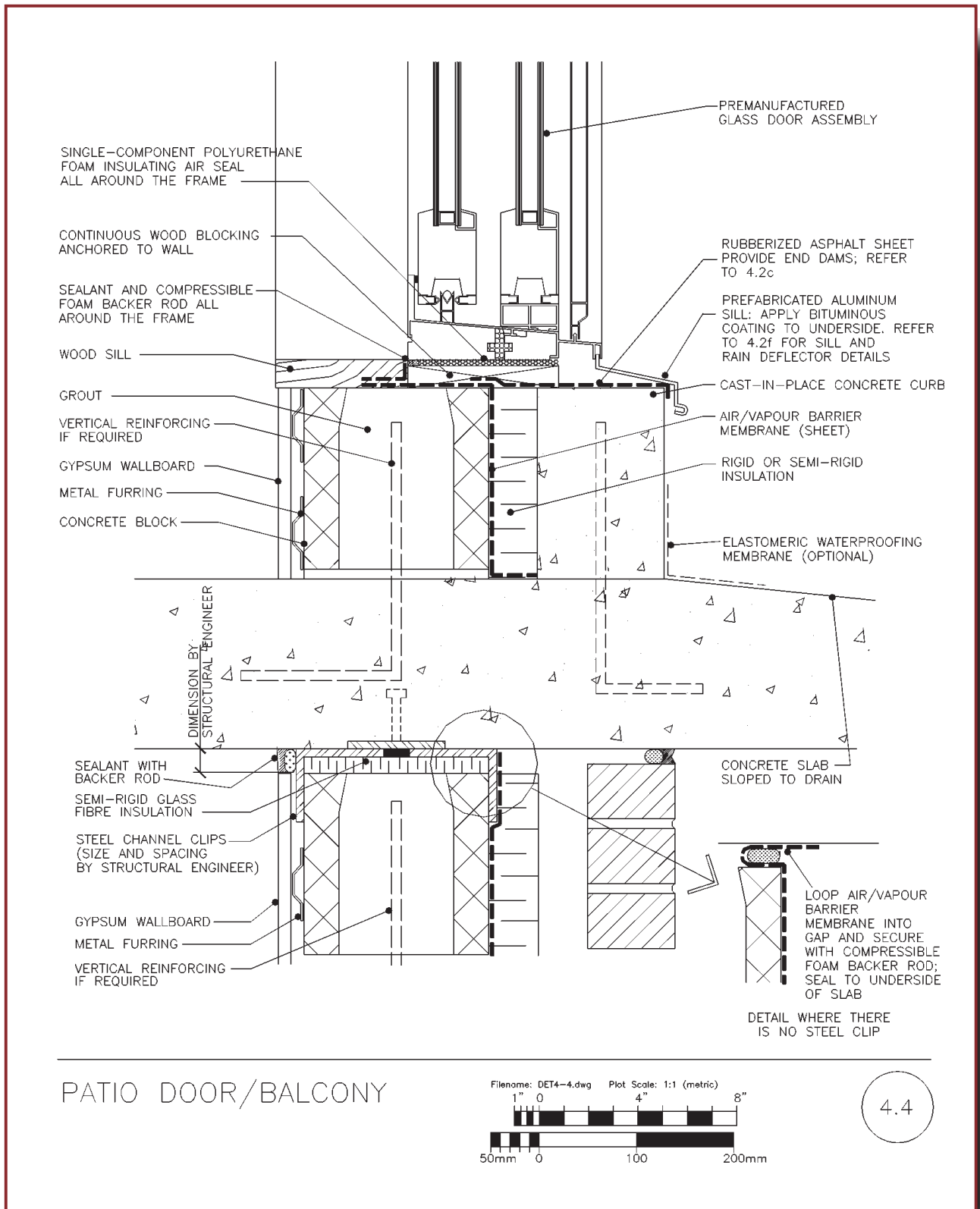

Detail 4.4: Patio Door/Balcony

DETAIL 4.5 — WALL/COLUMN

How It Works

- Wherever the back-up wythe is interrupted by structure, such as at a concrete column or shear wall, the air/vapour barrier membrane and insulation must maintain continuity. A continuous air barrier is a requirement of a pressure-equalized rain-screen wall.
- In sheet air/vapour barrier membrane systems, no separate flashing is required: the membrane is installed continuously from the block wall over the column face. These products can withstand differential movements between the concrete block and the structure.
- Insulating the structure on its outside face maintains it at the interior temperature, thereby minimizing thermal cycling of the structure and concrete block backing and maintaining the air/vapour barrier membrane at an even temperature. Thermal bridging is avoided with this detail, thereby minimizing heat losses.
- Depending on the structural design, a movement joint may be required between the concrete column and block wall.

Designer Checklist

- The drawings and specifications clearly detail how the air/vapour barrier membrane spans interruptions in the concrete block wythe.
- The structural drawings indicate how the concrete block wall is secured to the structure.

Builder Checklist

- The installation of the air/vapour barrier membrane and insulation is coordinated with the masonry work.
- Both the air/vapour barrier membrane and insulation are installed continuously across the column face or shear wall.
- The structural drawings specify the method of tying the concrete block wall to the structure.

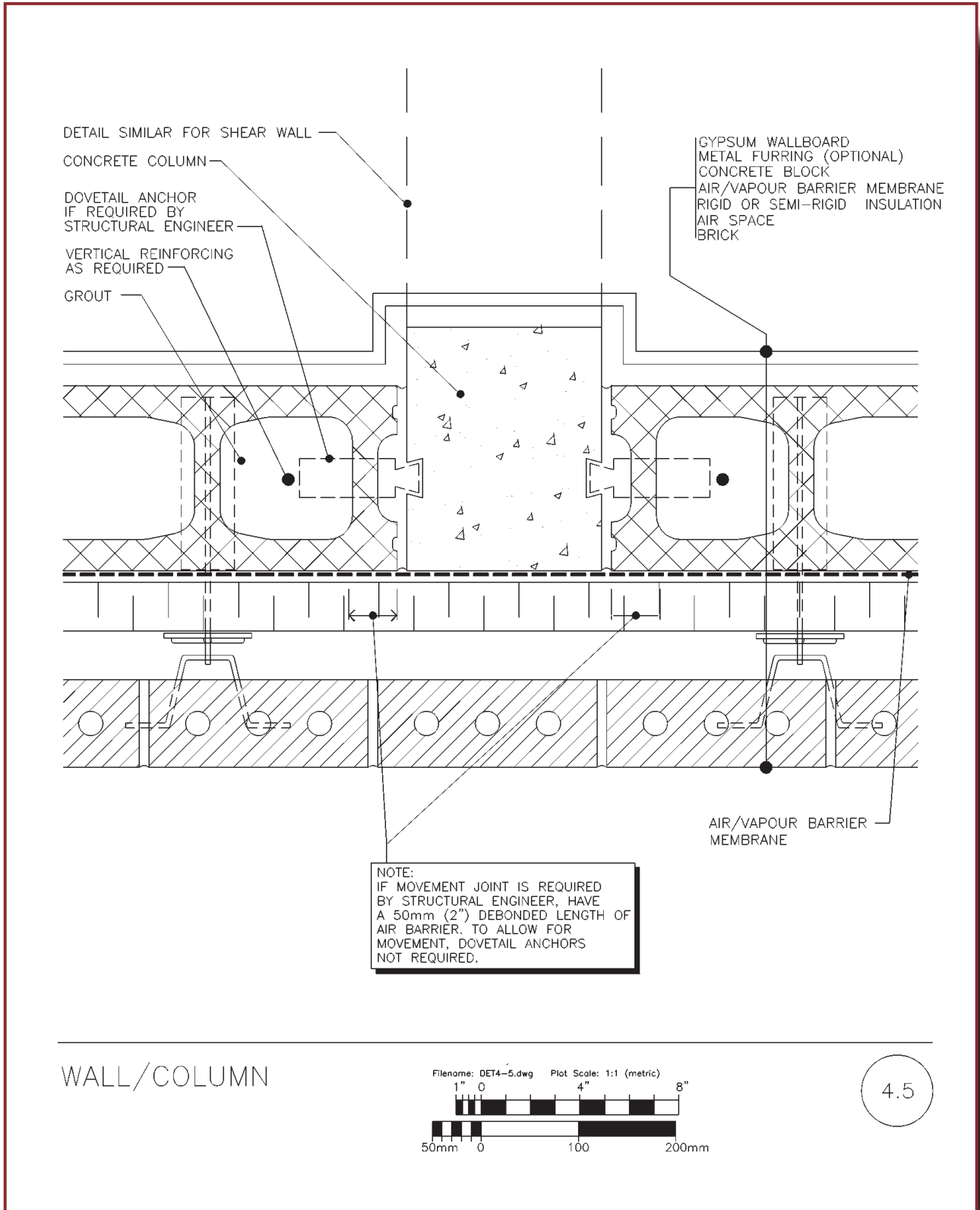

Detail 4.5: Wall/Column

DETAIL 4.6 — PARAPET/WALL

How It Works

- To prevent thermal bridging through the parapet and formation of condensation on the vapour barrier membranes, insulation is installed continuously over the top of the parapet, connecting the wall insulation to the roof insulation.
- To control air flow and water vapour diffusion through the building envelope, the air/vapour barrier membrane is made continuous with the roof vapour barrier, in the case of a conventional roof (as shown), or roof waterproofing, in the case of an inverted roof. A flexible membrane flashing on top of the parapet laps over the air/vapour barrier membrane on the wall and extends to the roof slab to lap over the roof vapour barrier.
- To prevent rain from penetrating the wall and roof, the roof-waterproofing system continues up and over the parapet to the exterior face of the wall. Wood blocking on the top of the parapet is required to support the waterproof membrane, where it may periodically be subject to foot traffic, for activities such as window washing.
- The waterproofing over the parapet is covered by metal counter flashing along the interior perimeter of the roof and cap flashing over the parapet to protect it from impact damage and ultraviolet deterioration. The cap flashing slopes toward the roof to prevent water from flowing toward the exterior face of the wall, to minimize wetting of the veneer below and also to protect pedestrians at ground level. Drip edge projections ensure that water drains away from the brick to prevent staining and away from the counter flashing onto the roof.
- A compressible joint is required at the top of the brick veneer and non-load-bearing concrete block at the underside of the concrete slab to allow for deflection, frame shortening and volume changes in brick and block. A gap is also required between the top of the insulation and underside of the concrete slab to prevent damage to the insulation or its delamination as a result of structural movement. A compressible joint is also desirable at the top of the gypsum wall board to allow movement.
- The discontinuous steel channel clips secured to the underside of the slab over the concrete block wall provide lateral support for the wall. Other methods are commonly used as selected by the designer, as specified by the structural engineer.
- The air/vapour barrier membrane is loosely laid over the deflection joint to allow for movement at this point.

Designer Checklist

- The air/vapour barrier and insulation are detailed to be continuous from the wall to the roof.
- The roof membrane flashing laps over the top of the parapet.
- A continuous metal corrosion-resistant cap flashing and counter flashing is specified.
- The cap flashing has a slope of at least 1:10 downward toward the roof and drip edge projections on both sides.

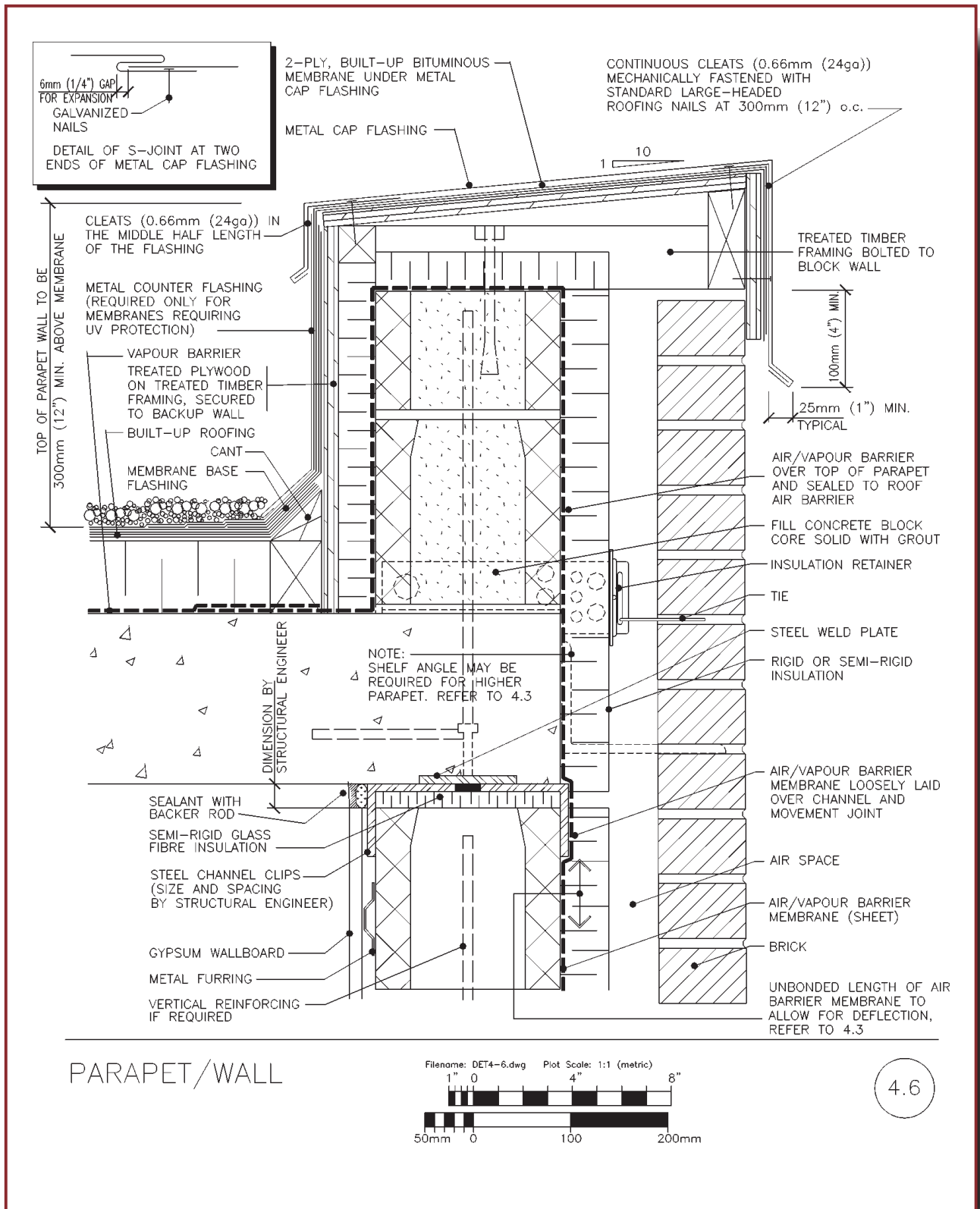

Detail 4.6: Parapet/Wall

- Cap flashings are jointed to allow for expansion and contraction of the metal.
 - Locked joints are specified to be without exposed fasteners. (See CMHC's *Best Practice Guide – Flashings* for further information.)
- The structural engineer has specified the minimum movement joint size under the slab above the concrete block wall.
 - The dimension for the joint includes an allowance for the thickness of the steel channel clips and the fully compressed insulation.
- The movement joint is detailed to be free of mortar.
- The air/vapour barrier membrane is shown to be continuous over the joint, but with an allowance for movement.
- The non-load-bearing concrete block wall is supported laterally.
- The installation of the air/vapour barrier and insulation is coordinated with the masonry work.
- The masonry work is coordinated with roofing.
- No exposed fasteners are used on metal flashings and fold-lock seams are used.
- The joint under the slab at the top of the wall is free of mortar and is the specified size.
- The air/vapour barrier membrane is continuous with the roof vapour barrier.
- The air/vapour barrier membrane is loosely laid over the movement joint to allow for deflection of the slab.
- The roof membrane base flashing is continuous over the parapet and all joints are sealed.
- The insulation is installed continuously from the wall face to the roof.

DETAIL 4.7a — WALL ABOVE FLAT ROOF

How It Works

- A concrete curb is provided for the roof waterproofing and to support the brick veneer above the roof surface. Brick is supported on a shelf angle connected to the concrete curb, using structural steel brackets. Ideally, the bottom course of brick should be at least 150 mm (6 in.) above the top of the roof insulation. This dimension depends on the thickness of the roof insulation, which could be considerable if tapered insulation is used to create the roof slopes for drainage, instead of sloping the roof slab. Building codes stipulate no minimum dimension.
- Moisture is drained toward the bottom of the wall within the cavity, where it is intercepted by the flashing over the shelf angle and directed to the exterior through weep holes.
- The air/vapour barrier membrane at the wall is lapped with the roof membrane.
- Through-wall flashing at the shelf angle is lapped and affixed to the air/vapour barrier membrane.
- Building codes require weep holes to be spaced at a maximum of 800 mm (32 in.) on centre for adequate cavity drainage. Maximum spacing of 600 mm (24 in.) on centre is recommended for better drainage and venting for pressure equalization.

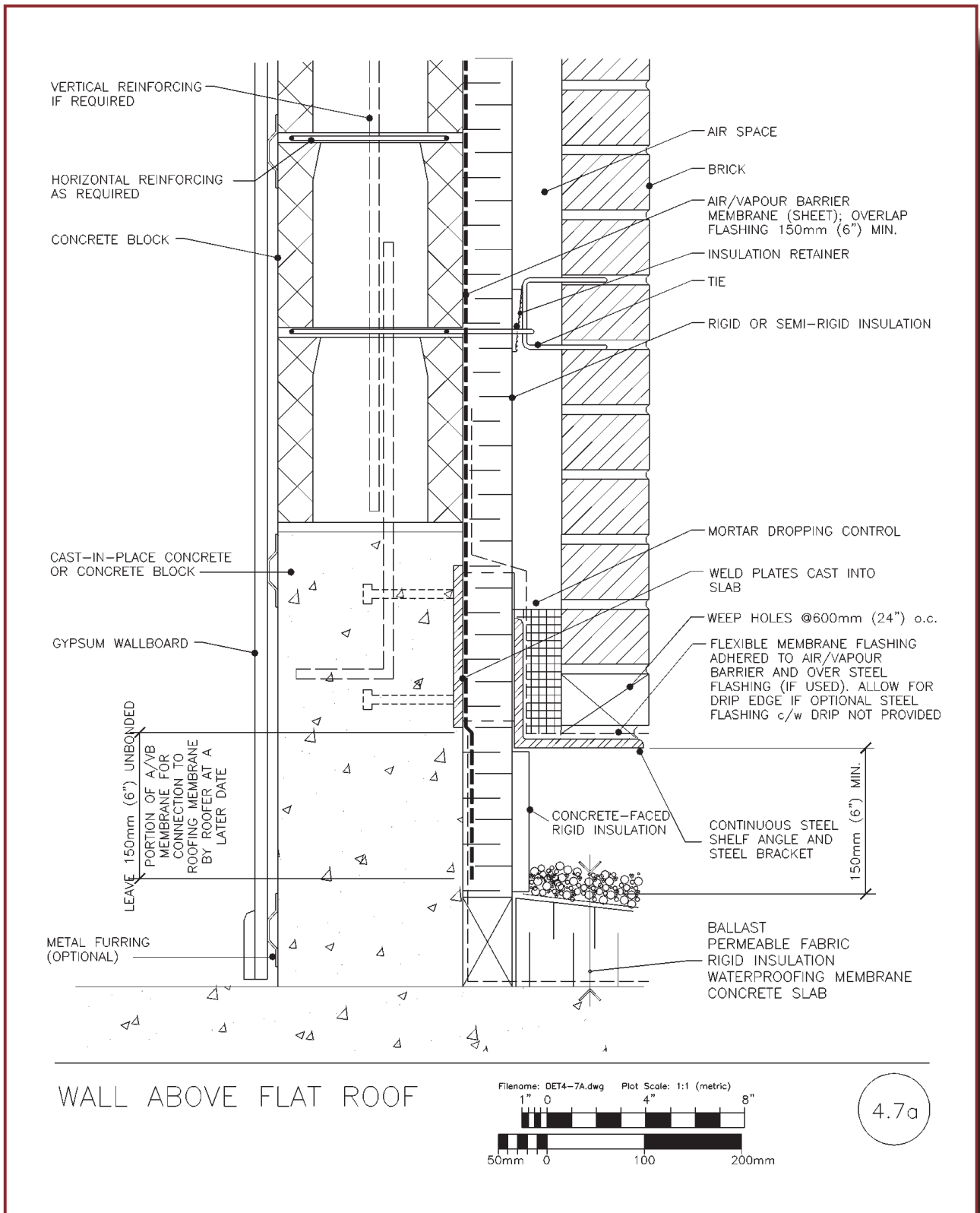

Detail 4.7a: Wall Above Flat Roof

- Weep holes must be kept free of mortar droppings to permit drainage and to vent the air space. Various technologies are available to help prevent plugging of weep holes. See “Sealants,” in Chapter 2.
- The effectiveness of the use of vent openings along the top of the wall cavity is not yet fully established. A CMHC research project is under way.
- Horizontal joints in the flashings must be lapped at least 100 mm (4 in.) and sealed to guard against moisture penetration at the joints.
- End dams are required at interruptions in the membrane flashing, such as at door openings or changes in the wall assembly, to prevent water from flowing into other assembly components or the building interior.

Designer Checklist

- The air/vapour barrier membrane is specified to be continuous with the roofing membrane.
- Weep-hole spacing is provided.
- Continuous flashings are specified and flexible flashings will not be exposed to damaging ultraviolet radiation.

Builder Checklist

- The installation of flashings, air/vapour barrier membrane and insulation is coordinated with the masonry work.
- The flashings are installed continuously, with joints lapped at least 100 mm (4 in.) and sealed.
- The ends of the membrane flashing are turned up to form dams at interruptions or changes in the wall assembly.
- The roof membrane and air/vapour barrier are continuous and properly lapped.

DETAIL 4.7b — PATIO DOOR/WALL ABOVE FLAT ROOF

How It Works

- At the door opening, the raised curb controls water penetration from the patio to the interior. The patio or roof deck must be sloped to drain water away from the door opening.
- The roof waterproofing system is continuous from the roof to up over the curb and terminates below the patio door assembly. The waterproofing acts as a secondary flashing under the sill to intercept possible water leakage.
- A continuous metal flashing is installed below the patio door sill, extending over the face of the curb to protect the waterproofing from impact damage and deterioration from exposure to ultraviolet radiation.
- The air/vapour barrier membrane is continuous with the door assembly to control the infiltration and exfiltration of air around the door opening. The membrane is affixed to the concrete block and returns into the door opening, where it is lapped onto the door frame and sealed.
- Insulation is placed between the concrete block and concrete block curb, rather than on the exterior face of the concrete curb, because it is important to align the thermal break in the patio door with the insulation.

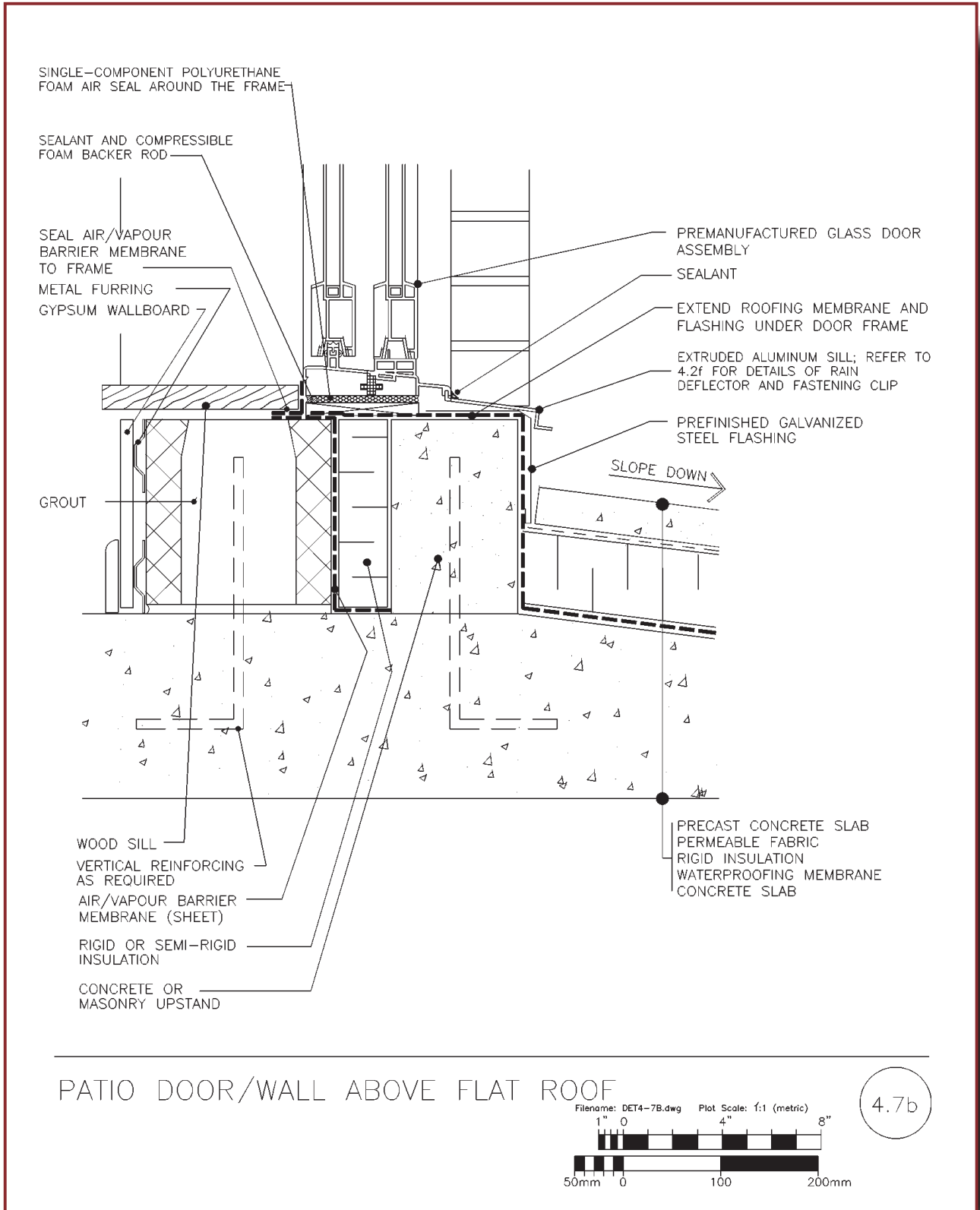

PATIO DOOR/WALL ABOVE FLAT ROOF

4.7b

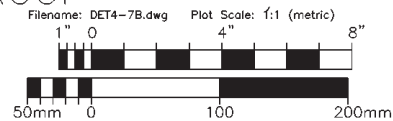

Detail 4.7b: Patio Door/Wall Above Flat Roof

- A continuous aluminum sill protects the waterproofing and sheet-metal flashing from damage from foot traffic. It is sloped to drain moisture away from the door.
- The joint between the sill and the door is sealed to prevent water penetration.
- Sealant is required at the joint between the ends of the sill and the brick at the jambs to prevent moisture from penetrating the wall assembly and the adjacent brick.

Designer Checklist

- A slope on the sill and the roof surface is specified to promote good drainage.
- The sill and flashing materials are specified to be continuous across the opening without joints.
- The air/vapour barrier membrane is detailed to be made continuous with the patio door, and this is coordinated with the specification sections for the window, masonry and air/vapour barrier membrane.
- Rain deflectors are specified at the jambs of the sill, complete with sealants.
- The thermal break in the patio door is aligned with the wall insulation to ensure that the interior section of the frame is on the warm side of the assembly.
- The waterproofing will not be exposed to damaging ultraviolet radiation.

Builder Checklist

- The installation of the air/vapour barrier, roofing membrane and patio door is coordinated with the masonry work.
- The sill and flashings do not have joints, where possible.
- The sill and roof are sloped to drain moisture away from the patio door.
- The caulking at the ends of the sill at the door jambs is tooled to direct water away from the adjacent brick.

DETAIL 4.8a — CANTILEVERED FLOOR

How It Works

- Moisture in the cavity drains to the bottom of the cavity at the shelf angle, where it is intercepted by the flashing and directed to the exterior through weep holes. A sheet-metal flashing extends beyond the edge of the steel angle, forming a drip edge that prevents water from tracking back onto the soffit. Rather, it is directed away from the building.
- End dams are required at the ends of the flashing, where the soffit terminates, to prevent water from flowing into other assembly components.
- Horizontal joints in the flashings must be lapped at least 100 mm (4 in.) and sealed to guard against moisture penetration at the joints.
- Building codes require weep holes to be spaced at a maximum of 800 mm (32 in.) on centre, for adequate cavity drainage. A maximum spacing of 600 mm (24 in.) on centre is recommended for both better drainage and venting for pressure equalization.
- Air flow and water vapour diffusion through the wall and soffit are controlled by a continuous air/vapour barrier membrane. A sheet air/vapour barrier membrane is installed on the exterior face of the concrete block.
- To prevent cold floors over the soffit area, the insulation must be in full contact with the wall, the slab edge and the underside of the slab. The wall insulation must not stop at the top of the shelf angle and must be made to fit tightly around the profile of the angle.
- The shelf angle is anchored to the soffit, using an angle clip and expansion anchors. Alternatively, a plate could be cast into the slab, with the shelf angle welded to the plate.
- Generally, metal flashings provide more effective drip edges than flexible flashings do. However, they are awkward to install as through-wall flashings. Flexible flashings should not be exposed to damaging ultraviolet radiation. Therefore, it is advisable to use a strip of sheet metal to form the drip edge, which is overlapped by a flexible membrane through-wall flashing. Both the sheet-metal and flexible flashings should be fully sealed to their substrates.

Designer Checklist

- A continuous flashing with a drip-edge projection is specified.
- The structural engineer has sized the shelf angle and detailed its installation.
- Corrosion protection is specified for the shelf angle and steel flashing.
- The air/vapour barrier membrane and insulation are shown to be continuous.
- Weep-hole spacing is provided.
- End dams are specified at flashing terminations.
- All slab penetrations and possible discontinuities in the air/vapour barrier membrane are detailed fully.

Builder Checklist

- The joints in the flashing are lapped at least 100 mm (4 in.), sealed and, in the case of membrane flashings, free of fish mouths.
- Flashings are sealed to their substrates.
- If flexible membrane flashing is used without a metal drip edge, the exposed edges are not cut off.
- A drip edge projects beyond the edge of the shelf angle.
- The installation of flashings, air/vapour barrier membrane and insulation is coordinated with the masonry work.
- Maximum brick corbel is one-third the thickness of the brick.
- Weep holes extend through the head joint and bed joint.
- The insulation is securely in contact with the wall.
- End dams are provided at changes in the wall assembly, with the ends of the flashing turned up and watertight.
- The cavity is reasonably clear of mortar droppings.
- Mechanical fasteners are installed for wall insulation.
- The air/vapour barrier membrane overlaps the through-wall flashing by at least 150 mm (6 in.).

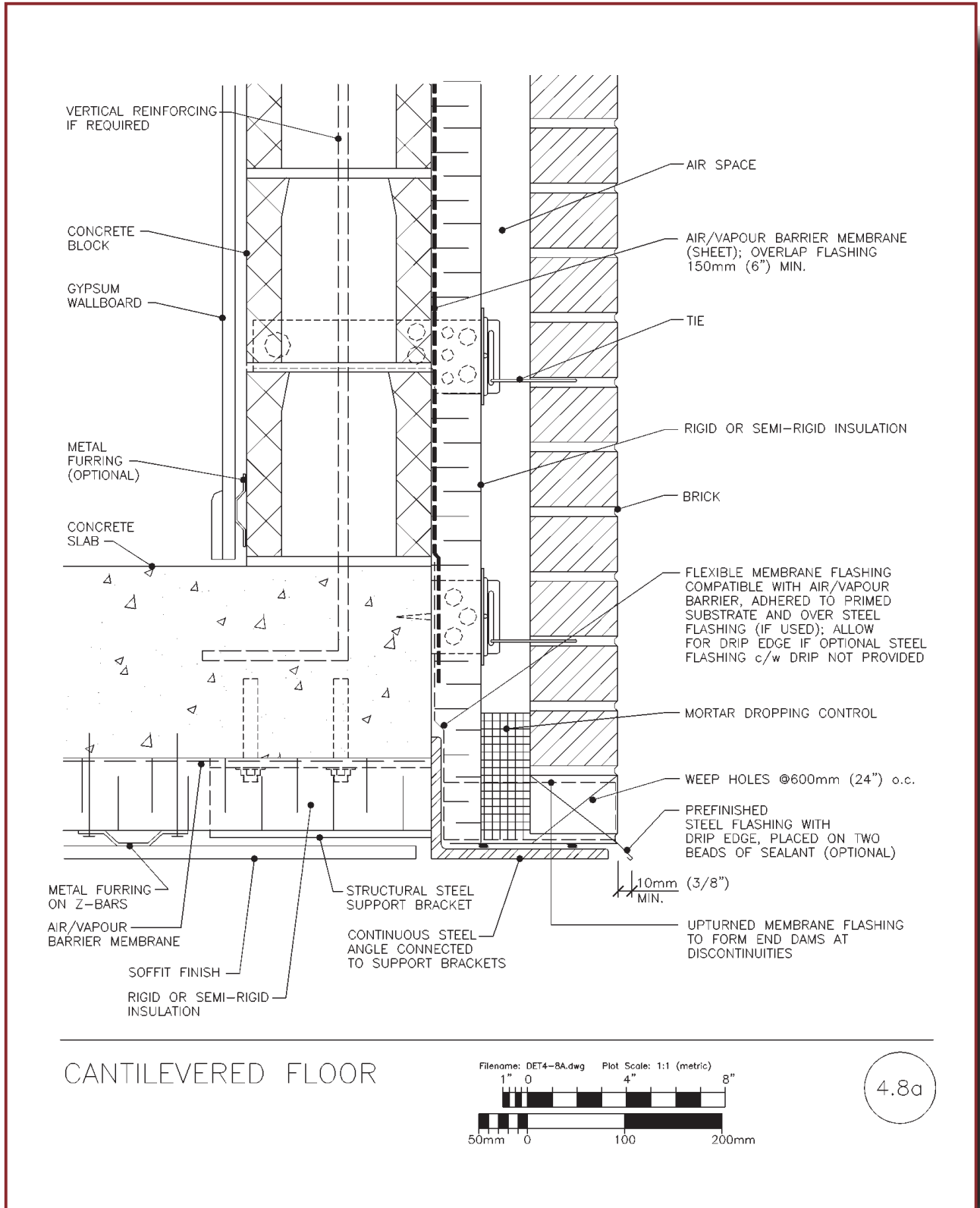

CANTILEVERED FLOOR

Detail 4.8a: Cantilevered Floor

DETAIL 4.8b — CANTILEVERED FLOOR

How It Works

- Air flow and water vapour diffusion through the wall and soffit are controlled by a continuous air/vapour barrier membrane. A sheet air/vapour barrier membrane is installed on the exterior face of the concrete block.
- To prevent cold floors over the soffit area, the insulation must be in full contact with the wall and underside of the slab.
- A compressible joint is required at the top of the brick veneer and non-load-bearing concrete block at the underside of the bent steel plate and concrete slab, to allow for deflection, frame shortening and volume changes in the brick and block. A gap is also required between the top of the insulation and underside of the bent steel plate to prevent damage to the insulation or its delamination as a result of structural movement. A compressible joint is also desirable at the top of the gypsum wall board and the underside of the slab to allow for movement.
- The discontinuous steel channel clips secured to the underside of the slab over the concrete block wall provide lateral support for the wall. Other methods are commonly used at the discretion of the designer and as specified by the structural engineer.

Designer Checklist

- The air/vapour barrier membrane and insulation are indicated to be continuous.
- The structural engineer has provided the minimum size of movement joint size.
 - The thickness of the fully compressed semi-rigid insulation and the thickness of the steel channel clips have been included in the calculation of the distance required between the slab and the concrete block wall.
- The non-load-bearing concrete block wall is supported laterally.
- The movement joint is detailed to be free of mortar.
- Allowances have been made for movement in the air/vapour barrier membrane at the movement joint.

Builder Checklist

- The installation of the air/vapour barrier membrane and insulation is coordinated with the masonry work.
- The insulation is securely in contact with the wall and soffit.
- Mechanical fasteners are installed for wall insulation.
- The sheet air/vapour barrier membrane overlaps the underside of the slab by at least 75 mm (3 in.).
- The movement joint is free of mortar and is no smaller than the minimum size specified.

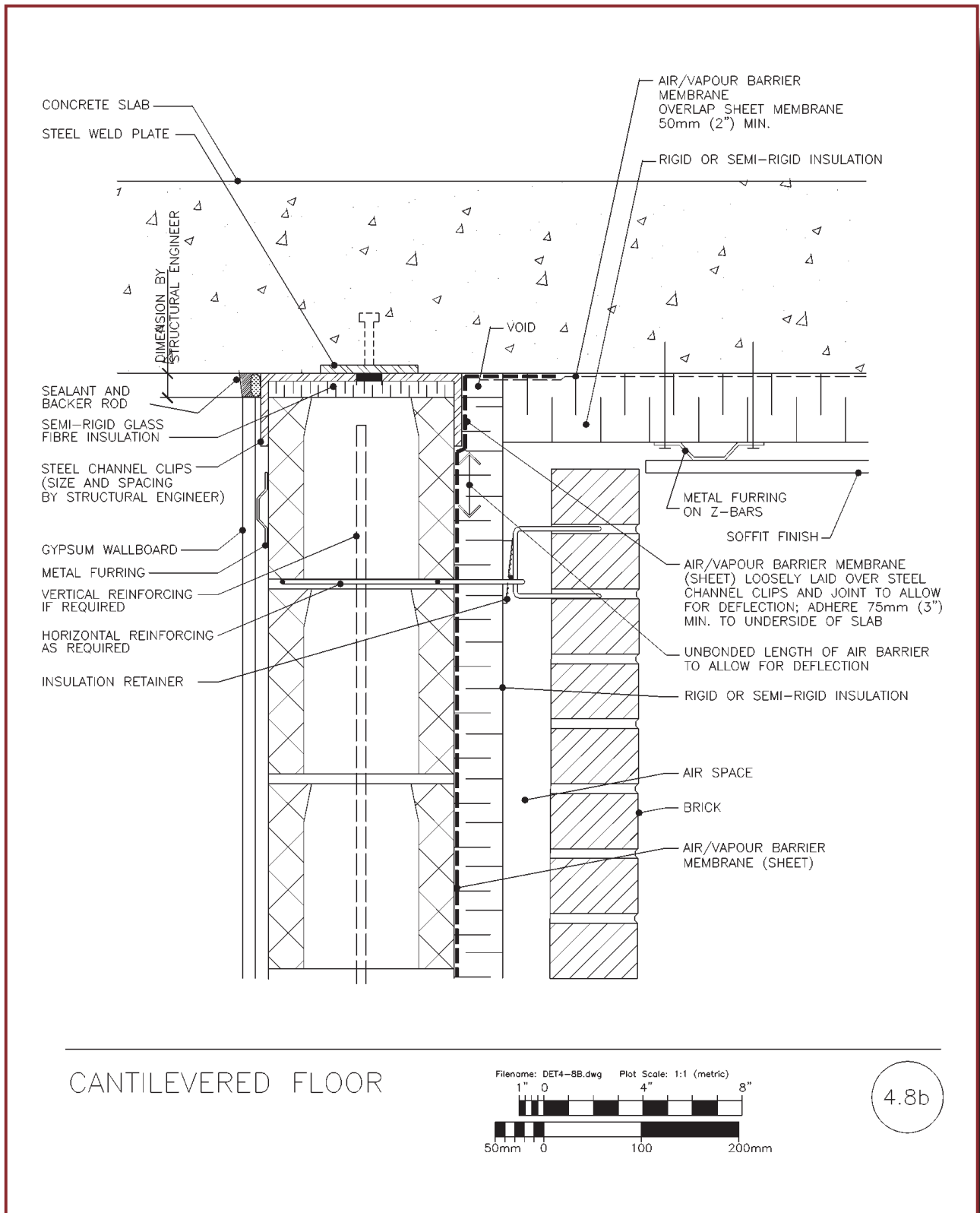

Detail 4.8b: Cantilevered Floor

DETAIL 4.9 — EXTERIOR AND INTERIOR CORNERS

How It Works

- To accommodate volume changes in the brick veneer, which may be significantly different from one building face to another, movement joints are recommended near the corners. At each interior or exterior corner, one movement joint should be positioned no closer to the corner than 1–2 m (3–6 ft.), and it should be positioned in the longest wall.
- To minimize moisture penetration, the cavity wall is pressure equalized. To achieve some measure of pressure equalization, the rain screen must be vented, and an effective air barrier must be provided within the back-up wall.
- Because concrete block is not an airtight material, a continuous air/vapour barrier membrane is required. The concrete block provides effective support for the air/vapour barrier.
- The largest air pressure differences occur at building corners. Airtight barriers across the cavity near the corners compartmentalize the rain screen, thereby controlling the pressure differential.
- Weep holes should be positioned away from the corners to prevent large air movements through the cavity, which not only promote moisture penetration, but also reduce the thermal resistance of the wall assembly.
- To compartmentalize the cavity, 0.91 mm thick (20 gauge) galvanized steel is secured to the concrete block back-up wall and held in place with sealant within the movement joint. The airtight barriers also meet building code requirements for fire stopping, where required.

Designer Checklist

- Brick movement joints on the drawings are 1 m back from both inside and outside corners in the long wall.
- Movement joints are detailed to include fire stopping as required by codes.
 - If this is not required to meet code requirements for fire stopping, the movement joints near corners contain an airtight barrier for pressure equalization of the cavity.
- Other materials used for fire stopping (if permitted by codes) are resistant to deterioration or corrosion caused by moisture and to the effects of wind loading.
- A continuous air/vapour barrier membrane is specified in the back-up wall and adequately supported by the wall.
- Weep holes are specified to be positioned away from the corners.

Builder Checklist

- The installation of the airtight metal barrier with masonry work and the installation of flashing.
- The metal barrier is installed airtight.
- The air barrier membrane is continuous with and securely affixed to the concrete block back-up wall.
 - Joints for surfaces that receive the air/vapour barrier membrane are flush.
- Weep holes are positioned away from corners and are free of mortar.

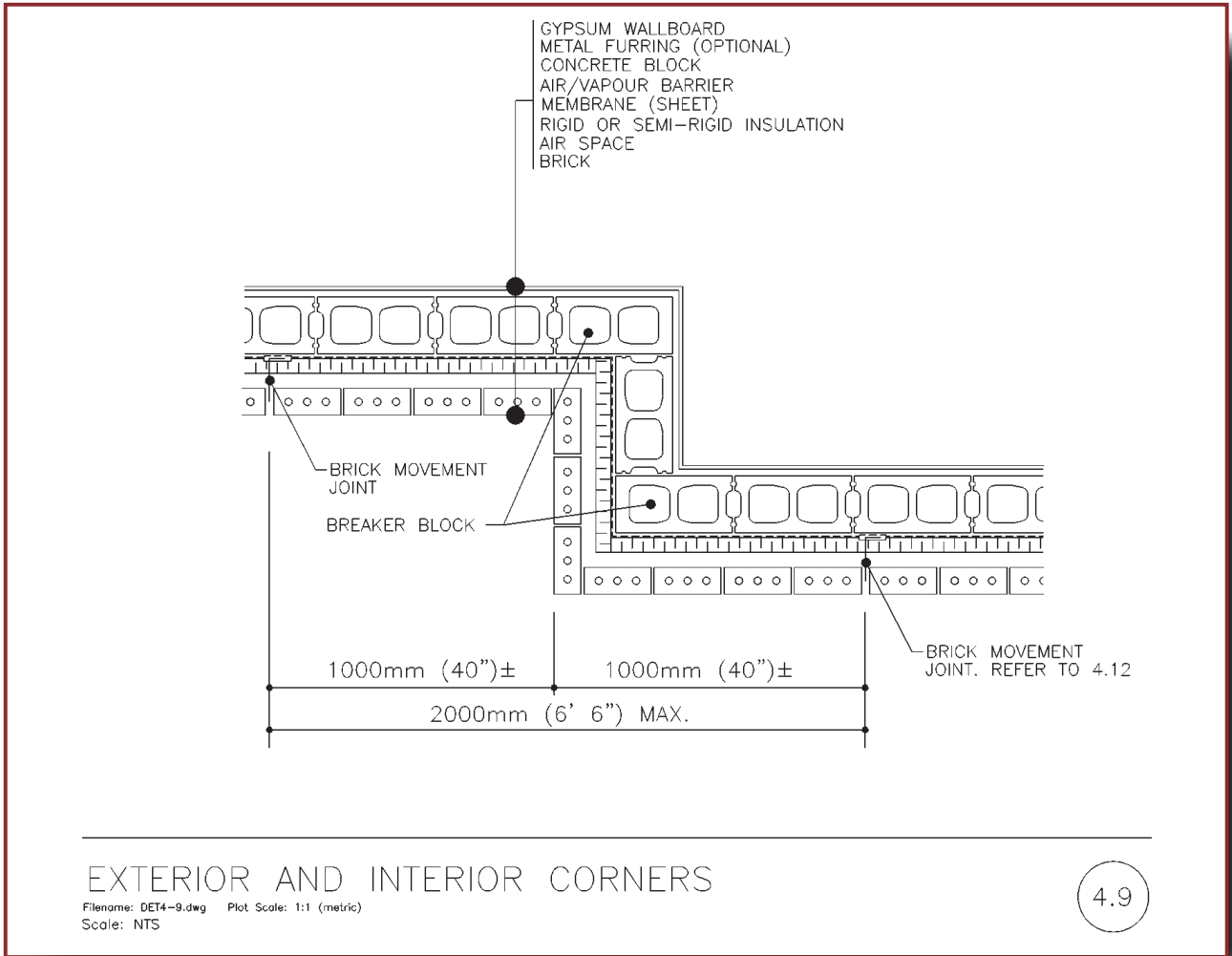

Detail 4.9: Exterior and Interior Corners

DETAIL 4.10a — CURTAIN WALL/SILL

How It Works

- Curtain walls are designed as pressure-equalized rain-screen walls and are therefore drained and vented. The connection details for the masonry wall must not interfere with the venting and drainage of the curtain wall.
- Water entering the curtain wall system is directed outward, at the sill mullions, to an aluminum sill extension that slopes to drain away from the curtain wall.
- The sill forms a drip edge that extends at least 25 mm (1 in.) beyond the brick face to shed water away from the masonry.
- Sealant at the joints between the ends of the sill and the brick at the jambs of the curtain wall opening protect adjacent bricks from saturation and leaks into the wall assembly.
- The joint between the curtain wall cap and aluminum sill is sealed to prevent moisture penetration.
- The air/vapour barrier membrane is continuous with the curtain wall to control that infiltration and exfiltration of air at the junction of the curtain wall and masonry wall. The membrane is affixed to the concrete block back-up wall and edge of the slab, and is returned over the slab. The air seal between the curtain wall frame and slab is provided by injecting single-component polyurethane foam, as shown.
- The thermal break of the curtain wall system is aligned with the wall insulation to minimize thermal bridging, which is inevitable at junctions of different wall components.
- The curtain wall is insulated within the spandrel panels and thermally broken under the pressure plates.
- A compressible joint is required at the top of the brick veneer and non-load-bearing concrete block at the underside of the bent steel plate and concrete slab to allow for deflection, frame shortening and volume changes in the brick and block. A gap is also required between the top of the insulation and underside of the bent steel plate to prevent damage to the insulation or its delamination as a result of structural movement. A compressible joint is also desirable at the top of the gypsum wall board and the underside of the slab, to allow for movement.
- The discontinuous steel channel clips secured to the underside of the slab over the concrete block wall provide lateral support for the wall. Other methods are commonly used at the discretion of the designer and as specified by the structural engineer.
- The effectiveness of the use of vent openings along the top of the wall cavity is not yet fully established. A CMHC research project is under way.

Designer Checklist

- The air/vapour barrier membrane connection is fully detailed and identified in the design documents and specifications, with coordination requirements fully outlined in the specifications.
- An allowance has been made for movement in the air/vapour barrier membrane at the movement joint.
- Shop drawings are specified and reviewed by the design team, with particular attention paid to anchorage details to ensure that anchorages do not interfere with the air/vapour barrier systems.

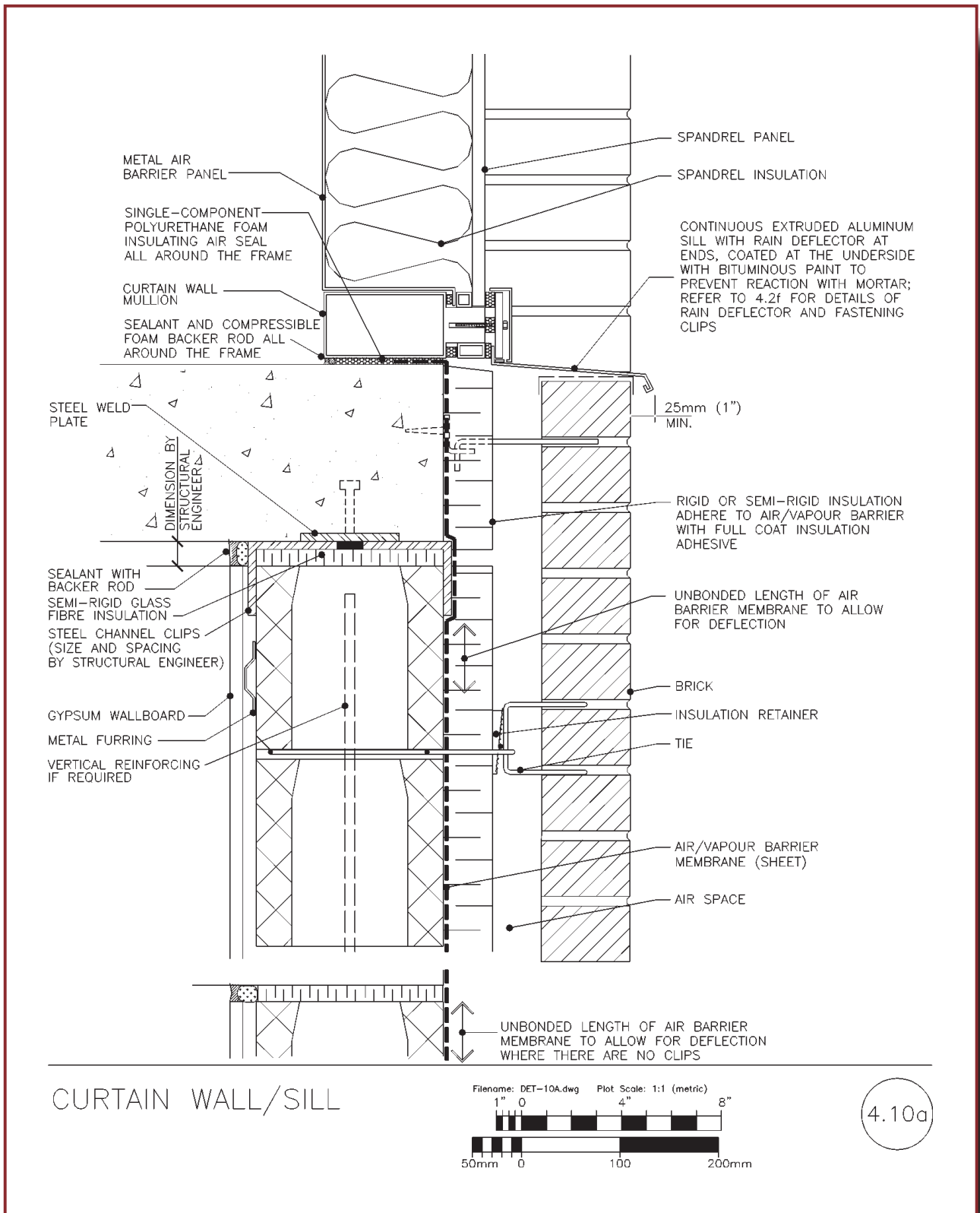

Detail 4.10a: Curtain Wall/Sill

- Mock-ups of the curtain wall, with full masonry junction details, are specified.
- A slope on the sill is specified to promote good drainage.
- A continuous extruded aluminum sill, without joints, is specified.
- Non-corroding and compatible materials are specified, and dissimilar metals and aluminum do not come in contact with mortar.
 - A bituminous coating or an impervious flexible membrane is installed underneath the sill.
- Rain deflectors and sealant are specified at the ends of the sill.
- A continuous drip edge projection is specified on the sill to shed water away from the wall below.
- The structural engineer has specified the minimum size of movement joint.
 - The thickness of the fully compressed semi-rigid insulation and the thickness of the steel channel clips have been included in the calculation of the distance required between the slab and the concrete block wall.
- The non-load-bearing concrete block wall is supported laterally.
- The movement joint is detailed to be free of mortar.

Builder Checklist

- Shop drawings have been submitted and reviewed prior to installation.
- The air/vapour barrier membrane is continuous over the connection, with all penetrations sealed or intended penetrations sleeved and ready for installation after cladding installation.
- All tradespeople and suppliers are aware of the design requirements of adjacent cladding systems and are involved in the sequencing decisions.
- Work on junction details is coordinated and inspected.
- Movement is provided at the floor slab-wall junction along the concrete block wall below, including provision for the air/vapour barrier membrane to accommodate this movement.
- Joints are avoided in the sill.
 - Where joints are unavoidable, a flashing is installed below the sill.
- The sill is sloped to drain water away from the curtain wall.
- The sill extends at least 25 mm (1 in.) beyond the exterior face of the wall below, to form a drip.
- The sealant at the ends of the sill at the curtain wall jambs is tooled to direct water away from the adjacent brick.
- The aluminum sill is not in direct contact with mortar, unless the sill is protected with a bituminous coating or an impervious flexible membrane.

DETAIL 4.10b — CURTAIN WALL/HEAD

How It Works

- Moisture is drained toward the bottom of the wall within the cavity, where it is intercepted by the flashing over the shelf angle and directed to the exterior through weep holes. A sheet-metal flashing extends beyond the exterior face of the brick veneer, forming a drip edge for water to be shed away from the curtain wall below.
- Horizontal joints in the flashings must be lapped at least 100 mm (4 in.) and sealed to guard against moisture penetration at the joints.
- A thermal bridge is unavoidable at the shelf angle supporting the brick veneer. The thermal break in the curtain wall is aligned with the insulation in the masonry wall assembly so that continuity of the insulation is possible at the sill and jamb.
- The air/vapour barrier consists of the sheet air/vapour barrier membrane adhered to the concrete block wall; the flexible membrane through-wall flashing affixed to the block, slab edge and shelf angle; the sealant between the curtain wall mullion and the concrete slab; the mullion itself; and the metal air barrier panel on the interior of the spandrel panel.
- A compressible joint is required at the top of the curtain wall frame and the underside of the bent steel plate and concrete slab to allow for deflection. All materials in the joint must be compressible. A sealant is used between the concrete slab and mullion to make the curtain wall system airtight. The joint between the curtain wall cap and the shelf angle is caulked to prevent rain from penetrating the curtain wall. The rest of the joint is filled with compressible insulation to reduce heat loss through this part of the wall.
- Sealant around the exterior perimeter of the curtain-wall frame provides a weather seal, preventing water from penetrating the wall cavity.

Designer Checklist

- The structural engineer has specified the minimum size of movement joint.
 - It is detailed to contain only compressible materials.
 - An allowance has been made for the thickness of the fully compressed insulation material.
- Corrosion protection is ensured for the shelf angle and steel flashing.
- The air/vapour barrier and insulation are as continuous as possible.
- A sheet-steel flashing is indicated with a drip edge extending beyond the shelf angle.
- Weep-hole spacing is provided.
- Shop drawings are specified and reviewed by the design team, with particular attention paid to anchorage details to ensure the anchorages do not interfere with the air/vapour barrier system.
- Mock-ups of the curtain wall are specified with full masonry junction details.

Builder Checklist

- The joint between the curtain wall head and structure above is the specified size.
 - No shims are used.
 - The joint allows for movement.
- Shop drawings are submitted and reviewed prior to installation.
- All air/vapour barrier penetrations are sealed or intended penetrations are sleeved and ready for installation after cladding installation.
- All tradespeople and suppliers are aware of the design requirements of adjacent cladding systems and are involved in the sequencing decisions.
- Work on junction details is coordinated and carefully inspected.
- The installation of flashings, air/vapour barrier and insulation is coordinated with the masonry work.
- The drip edge on the flashing projects beyond the shelf angle.
- Weep holes and air spaces are clear of mortar droppings.
- Weep holes extend through the head joint and bed joint.
- Flashings are continuous and installed with minimum 100 mm (4 in.) lap joints.
- The air/vapour barrier membrane laps over the through-wall flashing at least 150 mm (6 in.).

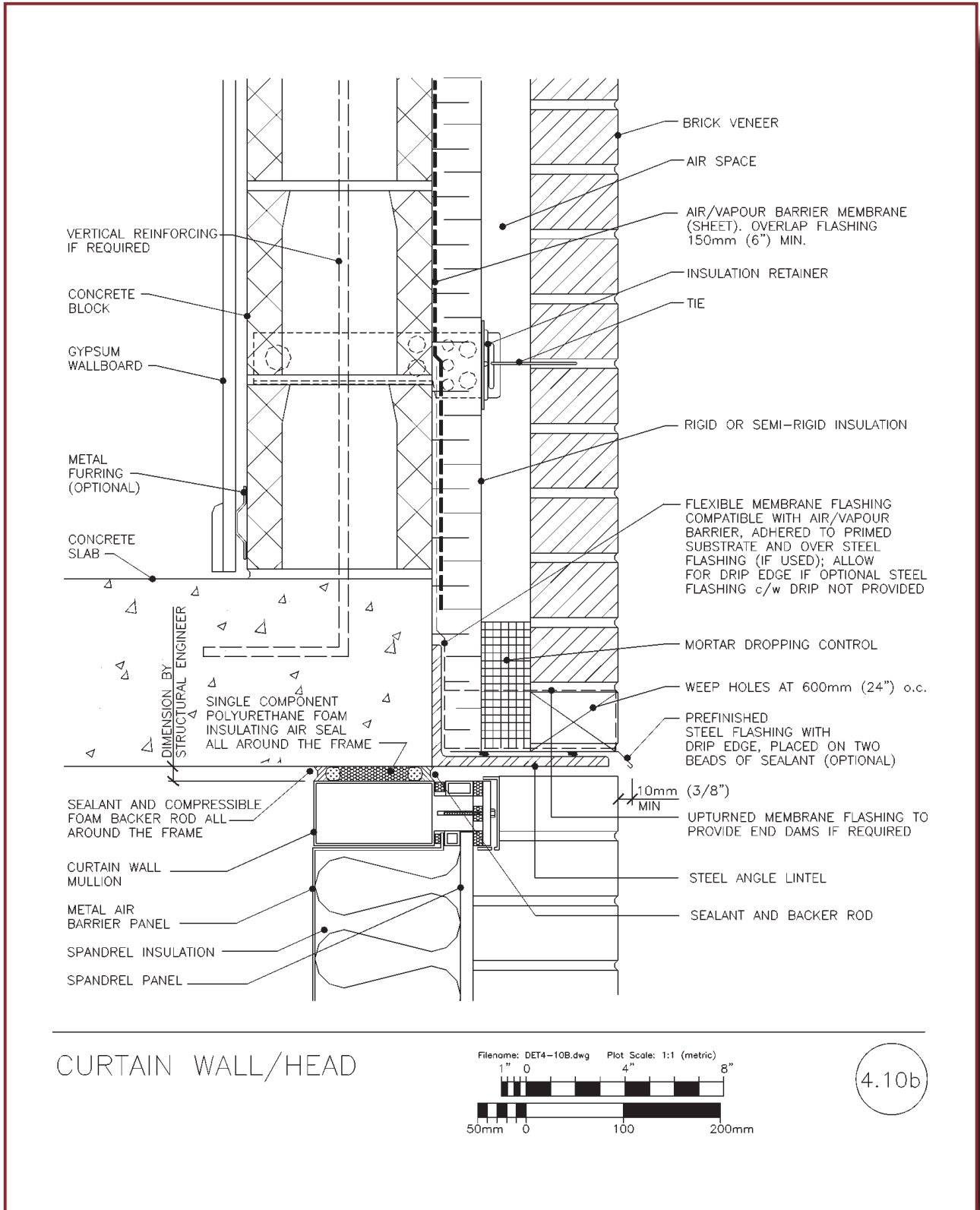

CURTAIN WALL/HEAD

Detail 4.10b: Curtain Wall/Head

DETAIL 4.11 — STRUCTURAL EXPANSION JOINT

How It Works

- The purpose of the expansion joint is to accommodate structural movement along a specific line in the building without affecting or transferring load or stress to other parts of the building. The masonry must have a clean joint for the full height of the wall, at a width determined by the structural engineer. No masonry construction, including masonry reinforcing or ties, should be continuous through the joint. All materials within or across the joint must either be flexible or free to move. (See “How It Works” for [Detail 4.12](#), (p. 4-65) for movement joints.)
- The joint must be sealed at the brick face to minimize the amount of water penetrating the wall.
- The air/vapour barrier membrane must be continuous across the joint. Regardless of whether the air/vapour barrier membrane is a sheet or liquid seal product, a separate flexible membrane flashing should span the joint. The flashing is looped into the joint, at 1½ times the width of the joint, to accommodate potential movement.
- With rigid insulation, a joint is left open to allow for movement, to prevent damage to the insulation and to prevent it from buckling, thus losing contact with the back-up wall. If compressible insulation is used, it is possible to make it span the joint, thus improving thermal resistance.
- An aluminum expansion joint cover, fastened to the wall from one side only, thus allowing movement at the joint, provides an aesthetically acceptable finish on the interior.

Designer Checklist

- The structural engineer has stipulated joint size and locations.
- The specified sealant is appropriate for the type and size of the joint.
- The drawings and specifications are clear about how the air/vapour barrier membrane is to span the expansion joint.
- The drawings and specifications clearly stipulate that no reinforcing should span across the joint.

Builder Checklist

- The joint is left free of mortar for the full height and is the correct width.
- Masonry joint reinforcement is discontinuous at the joint.
- Masonry units are cut with a masonry saw.

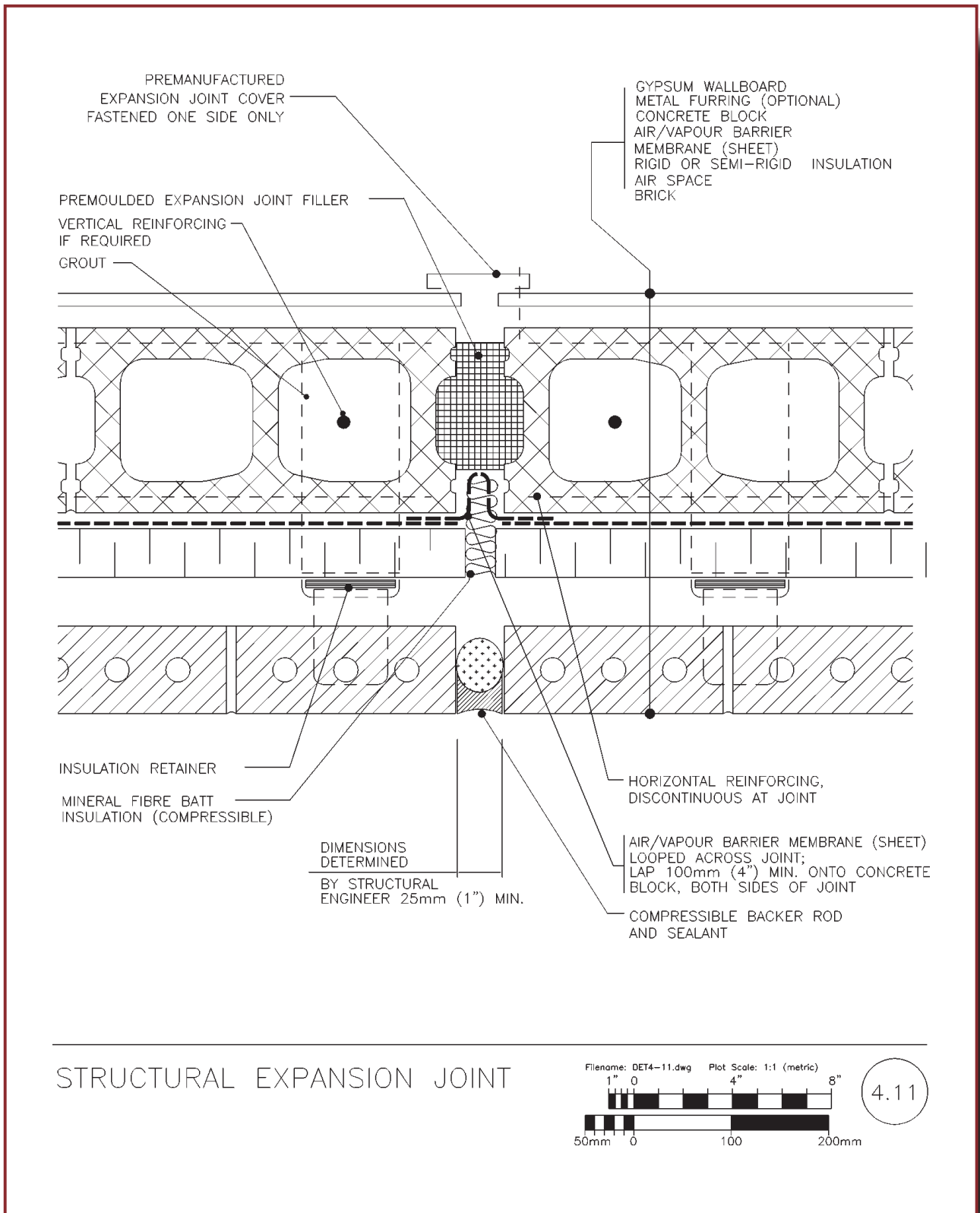

Detail 4.11: Structural Expansion Joint

DETAIL 4.12 — BRICK AND CMU MOVEMENT JOINT

How It Works

- Movement joints control cracking resulting from volume changes in the brick facing. The movement joints should be spaced at a maximum of about 7 m (23 ft.) for clay brick and 4 m (13 ft.) for concrete brick. Movement joints may also be required for the concrete block back-up wall, but not normally in residential construction, as the block wall would be frequently interrupted by building structure. See “How It Works” for [Detail 4.11](#), for expansion joints.
- A sheet of 0.91 mm thick (20 gauge) galvanized steel, secured to the concrete block back-up wall and held in place with sealant within the movement joint, provides an airtight barrier through the cavity. It acts as fire stopping and compartmentalizes the rain screen to allow for a measure of pressure equalization. See the *National Building Code* for fire-stopping requirements.
- One bead of sealant holds the fire stopping in place, making an airtight seal for it to function effectively, both as fire stopping and as a barrier that compartmentalizes the cavity. The second bead prevents moisture from penetrating the wall. The choice of sealant depends on the joint size and the amount of movement expected.

Designer Checklist

- Movement joints are located in long walls, at building corners (see [Detail 4.9](#), p. 4-55), at door and window openings, as required, at changes in wall heights and thickness, and at changes in wall direction.
- If conventional continuous welded-ladder or truss ties and reinforcing are specified, they are discontinuous across the joint.
- Building code requirements for fire stopping have been checked.
 - The fire stop material is resistant to deterioration or corrosion caused by moisture and to the effects of wind loading as well as to fire.
- The need for movement joints in the concrete block wythe has been assessed and, if required, locations and types of joint specified.

Builder Checklist

- The installation of the airtight barrier is coordinated with that of the air/vapour barrier membrane, masonry ties and shelf angles.
- The joint is free of mortar for the full height of the wall.
 - Units are cut with a masonry saw.
 - The joint is the correct width.
- Masonry joint reinforcement is discontinuous through the brick movement joint.
- The airtight barrier is secured to the masonry back-up wall.

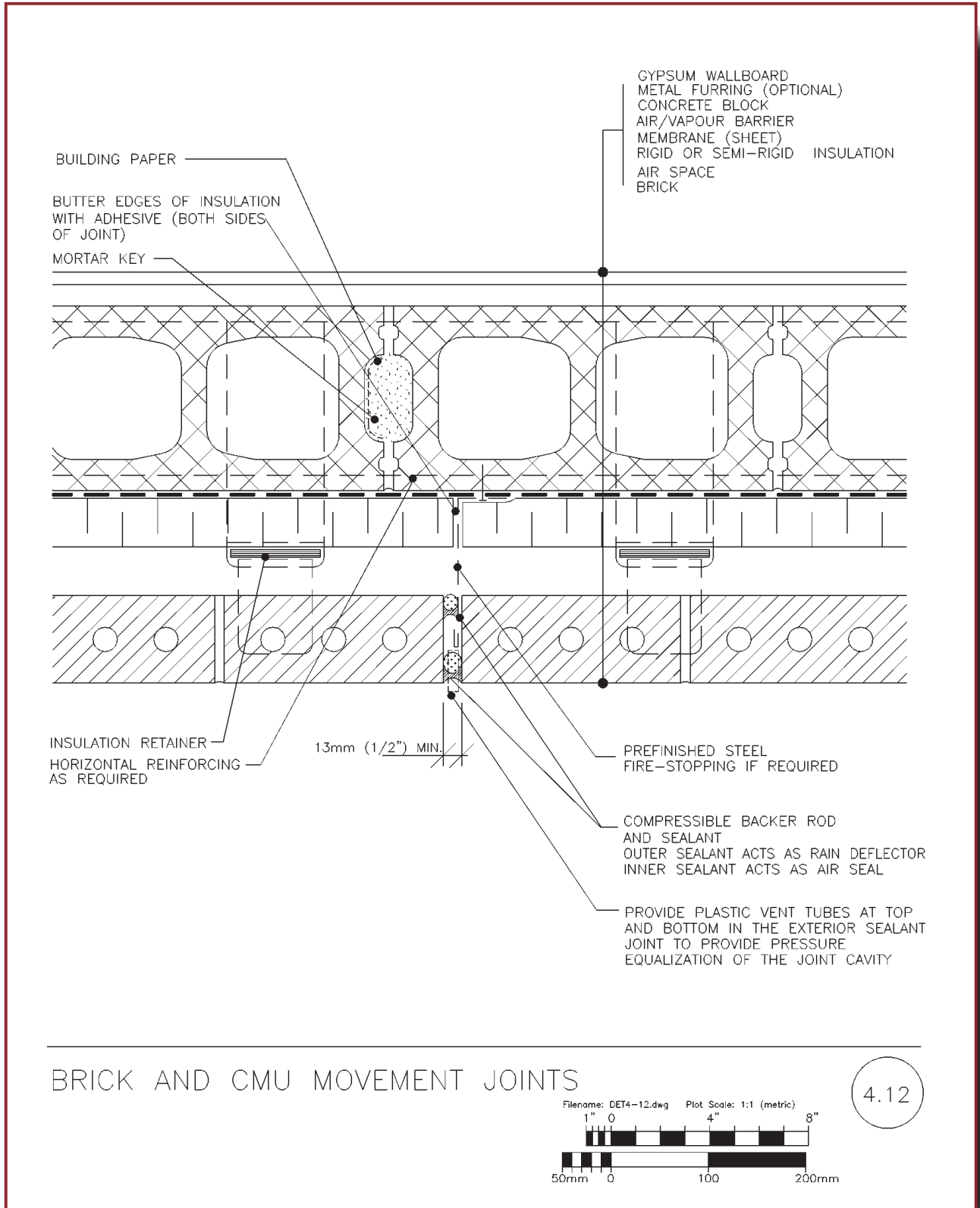

Detail 4.12: Brick and CMU Movement Joint

PREAMBLE

Specifications are the legal complement of plans and details. They should not duplicate the information on the drawings but guide the builder in developing the acceptable choice and application procedures for various materials. Designers must determine for themselves which documents carry information relating to material characteristics. Designers must ensure that the relevant information concerning application procedures is obtained from manufacturers and included in the specifications. The building specifications should include the following sections:

04050	Masonry Procedures
04100	Mortar and Grout for Masonry
04150	Masonry Accessories
04160	Masonry Reinforcing and Connectors
04220	Concrete Unit Masonry
07190	Air/Vapour Barrier Membrane
07210	Board Insulation
07620	Metal Flashings
07900	Sealants

The following specifications are samples, specifying materials and procedures consistent with the details in Chapter 4. These are not master specifications. Designers should explore the use of other methods and materials that conform to the relevant CSA Standards.

CMHC Best Practice Guide	MASONRY PROCEDURES	Section 04050
Brick Veneer/Concrete		May 30, 1997
Masonry Unit Backing		Page 1 of 8

PART 1 — GENERAL

1.1	<u>Related Work</u>	.1	Mortar and Grout for Masonry	Section 04100
		.2	Masonry Accessories	Section 04150
		.3	Masonry Reinforcing and Connectors	Section 04160
		.4	Brick Masonry	Section 04210
		.5	Concrete Unit Masonry	Section 04220
		.6	Air/Vapour Barrier Membrane Membrane	Section 07190
		.7	Board Insulation	Section 07210
		.8	Sealants	Section 07900
1.2	<u>Reference Standards</u>	.1	Do masonry work in accordance with A370-94, "Connectors for Masonry," and A371-94, "Masonry Construction for Buildings," except where specified otherwise. Maintain copies of these standards on job site during masonry work.	
1.3	<u>Job Mock-up</u>	.1	Construct typical exterior wall panel, 4 m (13 ft.) long incorporating window frame, sill, insulation and horizontal reinforcing, illustrating material interfaces and seals.	
		.2	Mock-up may not remain as part of the Work.	
		.3	Allow 24 h for inspection of mock-up by the Architect before proceeding with air barrier work.	
			Mock-Up Panel to Incorporate	
			Inner and outer wythes of masonry showing colours and textures	
			Reinforcing steel (window openings)	
			Shelf angles and supports	
			Anchors	
			Connectors and joint reinforcing	
			Flashing	
			Air/vapour barrier membranes	

CMHC Best Practice Guide MASONRY PROCEDURES Section 04050
 Brick Veneer/Concrete May 30, 1997
 Masonry Unit Backing Page 2 of 8

1.3 Job Mock-up
Cont'd

Board insulation and adhesive bedding
 Mechanical securement for board insulation
 Weep holes
 Vent holes
 Mortar-dropping control device
 Mortar and grouting
 Window and lintel
 Sealants

The above construction will be observed by the
 Owner's Representative [] to verify
 conformance with specifications.

Masonry Units

Size
 Tolerances
 Chippage
 Warpage

Aesthetic Criteria

Unit placement/bonding pattern
 Alignment of joints
 Joint tooling and size
 Joint colour and conformity
 Blending of masonry units
 Tolerances

Acceptable Levels of Workmanship and
 Procedural Requirements

Placement of reinforcement
 Placement of joint reinforcing, laps, splicing
 Location of connectors
 Installation of flashing
 Installation of air/vapour barrier
 Installation of sealants
 Prevention of mortar droppings in wall cavities

On acceptance by the Owner's
 Representative []

Architect
 Engineer
 Construction Manager
 Independent Masonry Inspector

CMHC Best Practice Guide MASONRY PROCEDURES Section 04050
Brick Veneer/Concrete May 30, 1997
Masonry Unit Backing Page 4 of 8

- 1.6 Product Delivery .1 Deliver materials to job site in dry condition.
Storage and
Handling .2 Keep materials dry until use, except where
wetting of bricks is specified.
- .3 Store under waterproof cover on pallets or
plank platforms held off ground by means of
plank or timber skids.
- 1.7 Cold Weather .1 When air temperature is below 5°C (41°F),
Requirements take following precautions in preparation and
use of mortar:
- .1 Air temperature 0–4°C (32–40°F):
Heat sand or mixing water to a minimum
of 20°C (68°F) and a maximum of
70°C (158°F).
- .2 Air temperature -4–0°C (25–32°F):
Heat sand and mixing water to a
minimum of 20°C (68°F) and a maximum
of 70°C (158°F).
- .3 Air temperature -7–-4°C (19–25°F):
Heat sand and mixing water to a
minimum of 20°C (68°F) and a maximum
of 70°C (158°F). Provide heat on both
sides of walls under construction. Use
windbreaks when wind exceeds 25 km/h
(15 mph).
- .4 Air temperature -7°C (19°F) and below :
Heat sand and mixing water to a
minimum or 20°C (68°F) and a maximum
of 70°C (158°F). Provide enclosures and
auxiliary heat to maintain an air
temperature above 0°C (32°F). The
temperature of the unit when laid shall be
not less than -7°C (19°F).
- .2 Maintain dry beds for masonry and use dry
masonry units only. Do not wet masonry units
in cold weather.

CMHC Best Practice Guide	MASONRY PROCEDURES	Section 04050
Brick Veneer/Concrete		May 30, 1997
Masonry Unit Backing		Page 5 of 8

- | | | | |
|-----|---------------------------------|----|---|
| 1.8 | <u>Hot Weather Requirements</u> | .1 | Protect freshly laid masonry from drying too rapidly, by means of waterproof, non-staining coverings. When air temperature is above <ul style="list-style-type: none"> • 38°C (100°F) or • 32°C (90°F) with wind velocity greater than 13 km/h (21 mph), spread of mortar beds shall be limited to 1.2 m (4 ft.), and the masonry units shall be set within 1 minute of spreading the mortar. |
| 1.9 | | | <u>Protection</u> |
| | | .1 | Keep masonry dry using waterproof, non-staining coverings that extend over walls and down sides sufficiently to protect walls from wind-driven rain, until masonry work is completed and protected by flashings or other permanent construction. |
| | | .2 | Protect masonry and other work from marking and other damage. Protect completed work from mortar droppings. Use non-staining coverings. |
| | | .3 | Provide temporary bracing of masonry work during and after erection until permanent lateral support is in place. |
| | | .4 | Comply with section 5.16.3 of CSA A371-94 for protection requirements for completed masonry not being worked on. |

PART 2 — PRODUCTS

2.0 Submittals

MASONRY SUBMITTALS CHECKLIST

Shop Drawings

- Fabrication dimensions and placement locations for reinforcing steel and accessories
- Flashing details
- Temporary wall bracing

Product Data

- Proprietary mortar ingredients
 - Portland cement
 - Masonry cement
 - Mortar cement
 - Lime
 - Admixtures
- Accessory items
- Joint reinforcement

CMHC Best Practice Guide	MASONRY PROCEDURES	Section 04050
Brick Veneer/Concrete		May 30, 1997
Masonry Unit Backing		Page 6 of 8

- 2.0 Submittals
- Cont'd
- Shear keys
 - Weep-hole ventilators
 - Cleaning agents

Samples

- Units
- Mortar colour
- Connectors
- Accessories

Quality Assurance/Quality Control Submittals

- Design data
 - Mortar mix designs
 - Grout mix designs
- Test reports
 - Preconstruction testing
 - Field testing
 - Source quality control testing
- Certifications
 - Compliance with specified requirements
 - Compliance with specified ASTM standards
 - Brick IRA
- Inspection reports
 - Materials
 - Protection measures
 - Construction procedures
 - Reinforcement
 - Grouting
- Manufacturers' instructions
 - Cleaning agents
 - Mortar colouring pigments
- Manufacturers' field reports
 - Cleaning operations
- Proposed hot- or cold-weather construction procedures

- 2.1 Materials
- .1 Masonry materials are specified in related sections indicated in 1.1.

CMHC Best Practice Guide MASONRY PROCEDURES Section 04050
 Brick Veneer/Concrete May 30, 1997
 Masonry Unit Backing Page 7 of 8

PART 3 — EXECUTION

- 3.1 Workmanship
 - .1 Build masonry plumb, level and true to line, with vertical joints in alignment.
 - .2 Lay out coursing and bond to achieve correct coursing heights, and continuity of bond above and below openings, with minimum of cutting.
- 3.2 Tolerances
 - .1 Tolerances in notes to Clause 5.3 and 5.13 of CSA A371-94 apply.
- 3.3 Exposed Masonry
 - .1 Do not use cracked or damaged units in exposed or loadbearing masonry wall except as permitted by CAN/CSA A82.1-M82, “Burned Clay Bricks.”
- 3.4 Jointing
 - .1 Allow joints to set just enough to become thumbprint hard, then tool with a round stainless steel jointer to provide smooth, compressed, uniformly concave joints where joints are exposed.
 - .2 Strike flush all joints concealed in walls and joints in walls to receive plaster, tile, insulation or other applied material except paint or similar thin-finish coating.
- 3.5 Cutting
 - .1 Cut out neatly for electrical switches, outlet boxes, and other recessed or built-in objects.
 - .2 Make cuts straight, clean and free from uneven edges.
- 3.6 Wetting of Masonry
 - .1 Except in cold weather, wet clay bricks having an IRA exceeding 30 g/min/194 cm² (0.066 lb./min./03 in.²): wet to uniform degree of saturation, 3 to 24 hours before laying, and do not lay until surface dry.
 - .2 Wet tops of walls built of bricks qualifying for wetting, when recommencing work on such walls.
 - .3 Do not wet concrete masonry units prior to use.

CMHC Best Practice Guide	MASONRY PROCEDURES	Section 04050
Brick Veneer/Concrete		May 30, 1997
Masonry Unit Backing		Page 8 of 8

- | | | | |
|-----|--------------------|----|---|
| 3.7 | <u>Building-In</u> | .1 | Build in items required to be built into masonry. |
| | | .2 | Prevent displacement of built-in items during construction. Check plumb, location and alignment frequently, as work progresses. |
| | | .3 | Brace door jambs to maintain plumb. Fill spaces between jambs and masonry with mortar. |
- | | | | |
|-----|-------------------------|----|--|
| 3.8 | <u>Support of Loads</u> | .1 | Use grout to CSA A179-94 where grout is used in lieu of solid units. |
| | | .2 | Install building paper or metal lath below voids to be filled with grout; keep paper 25 mm (1.0 in.) back from faces of units. |
- | | | | |
|-----|-------------------------------|----|---|
| 3.9 | <u>Provision for Movement</u> | .1 | Leave [] mm space below shelf angles. |
| | | .2 | Leave [] mm space between top of non-load-bearing walls and partitions and structural elements. Do not use wedges. |
- | | | | |
|------|----------------------------|----|---|
| 3.10 | <u>Loose Steel Lintels</u> | .1 | Install loose steel lintels. Centre over opening width. |
| | | .2 | Provide polyethylene bond breaker at the underside shelf angle/top of masonry bearing surface. |
| | | .3 | Affix bond breaker tape to leading edge of shelf angle at bearing location, and caulk masonry to masonry. |
- | | | | |
|------|------------------------|----|---|
| 3.11 | <u>Movement Joints</u> | .1 | Provide movement joints as indicated. Provide plastic vent tubes as required by drawings. |
|------|------------------------|----|---|
- | | | | |
|------|----------------|----|---|
| 3.12 | <u>Testing</u> | .1 | Inspection and testing will be carried out by Testing Laboratory designated by Owner. |
| | | .2 | Owner will pay costs for testing. |

END OF SECTION 04050

CMHC Best Practice Guide Brick Veneer/Concrete Masonry Unit Backing	MORTAR AND GROUT FOR MASONRY	Section 04100 May 30, 1997 Page 1 of 2
---	---------------------------------	--

PART 1 — GENERAL

- 1.1 Related Work .1 Masonry Procedures Section 04050
- 1.2 Reference Standard .1 Do masonry mortar and grout work in accordance with CSA A371-94, except where specified otherwise.
- 1.3 Samples .1 Submit samples in accordance with submittal requirements.
- .2 Submit two 300 mm (12 in.) samples of coloured mortar.

PART 2 — PRODUCTS

- 2.1 Material .1 CSA A179-94, “Mortar and Grout for Unit Masonry”
- .2 Mortar and grout aggregate shall conform to CSA A179-94.
- .3 Colour: ground-coloured natural aggregates or metallic oxide pigments.
- .4 Water: free of deleterious matter and acids or alkalis.
- 2.2 Material Source .1 Use same brands of materials and source of aggregate for entire project.
- 2.3 Mortar Types .1 Mortar for exterior masonry above grade:
 - .1 Load-bearing: Type [S] or [N] based on proportion specifications.
 - .2 Non-load-bearing: Type [S] or [N] based on proportion specifications.
 - .3 Parapet walls and unprotected walls: Type [S] or [N] based on proportion specifications.
- .2 Mortar for foundation walls and other exterior masonry at or below grade: Type S based on proportion specifications.

CMHC Best Practice Guide	MORTAR AND GROUT	Section 04100
Brick Veneer/Concrete	FOR MASONRY	May 30, 1997
Masonry Unit Backing		Page 2 of 2

- | | | | |
|-----|--------------------------------------|----|---|
| 2.3 | <u>Mortar Types</u>
<u>Cont'd</u> | .3 | Mortar for interior masonry: |
| | | .1 | Load-bearing: Type [S] or [N] based on proportion specifications. |
| | | .2 | Non-load-bearing: Type N based on proportion specifications. |
| 2.4 | <u>Coloured Mortar</u> | .1 | Coloured mortar: use colouring admixture not exceeding 10% of cement content by mass, or integrally coloured masonry cement, to produce coloured mortar to match approved sample. |
| | | .2 | Use coloured mortar for masonry veneer work. |
| 2.5 | <u>Grout</u> | .1 | Grout shall be [fine] or [coarse] by the proportion specification in accordance with Table 3, CSA 179-94. |

PART 3 — EXECUTION

- | | | | |
|-----|---------------|----|---|
| 3.1 | <u>Mixing</u> | .1 | Mix grout to semi-fluid consistency. |
| | | .2 | Incorporate colour into mixes in accordance with manufacturers' instructions. |
| | | .3 | Use clean mixer for coloured mortar. |
| | | .4 | Use mortar within 2 hours after mixing. Retempering shall be permitted. |

END OF SECTION 04100

CMHC Best Practice Guide MASONRY ACCESSORIES Section 04150
 Brick Veneer/Concrete May 30, 1997
 Masonry Unit Backing Page 1 of 2

PART 1 — GENERAL

- | | | | | |
|-----|---------------------|----|---|---------------|
| 1.1 | <u>Related Work</u> | .1 | Masonry Procedures | Section 04050 |
| | | .2 | Masonry Reinforcing and Connectors | Section 04160 |
| 1.2 | <u>References</u> | .1 | CSA A371-94, “Masonry Construction for Buildings” | |

PART 2 — PRODUCTS

- | | | | | |
|-----|------------------|----|--|--|
| 2.1 | <u>Materials</u> | .1 | Masonry flashings: | |
| | | .1 | Self-adhering rubberized asphalt bonded to high-density, cross-laminated polyethylene, nominal total thickness of 1 mm (0.039 in.). | |
| | | | OR | |
| | | .2 | SBS modified bitumen reinforced with proprietary glass scrim, nominal total thickness of []. | |
| | | .3 | Galvanized steel 0.33 mm (0.013 in.) (minimum) core nominal thickness, Z275 zinc coating designation, to ASTM A525M-80, prefinished to CGSB 93-GP-3M, Class FIS. | |
| | | .4 | Adhesive: recommended by manufacturer of flashing material. | |
| | | .5 | Primer: recommended by manufacturer of self-adhering flashing. | |
| | | .6 | Plastic cement for caulking and bedding metal flashings shall conform to CGSB 37-GP-5M. | |
| | | .2 | Mortar dropping control device: polyethylene net 90% open weave, 250 mm (8 in.) high or [] or []. | |

CMHC Best Practice Guide MASONRY ACCESSORIES Section 04150
Brick Veneer/Concrete May 30, 1997
Masonry Unit Backing Page 2 of 2

PART 3 — EXECUTION

- 3.1 Masonry Flashing .1 Install flashing in masonry in accordance with CSA A371-94, as shown on the drawings.
- .2 Carry flashings from front edge of masonry, under outer wythe, then up exterior face of inner wythe.
- .3 Prime all surfaces to receive self-adhering flashing.
- .4 Adhere [reinforced modified bitumen] flashing in full coat of adhesive to all substrates.
- .5 Where an air barrier membrane is present in the cavity, adhere the air barrier membrane to the flashing.
- .6 Lap joints of flexible flashings 50 mm (2 in.) and seal. Use adhesive for reinforced modified bitumen flashing.
- .7 Lap joints of polyvinyl chloride flashing 100 mm (4 in.) minimum and seal with adhesive.
- .8 Metal flashings to be furnished and cut to size by a sheet-metal contractor, for installation by masonry contractor. All joints to lap 100 mm (4 in.) minimum and be soldered.
- .9 For through-wall flashings, extend the flashing 10 mm (0.4 in.) minimum beyond the exterior face of the brick.
- 3.2 Mortar Dropping Control Device .1 Install continuous mortar dropping control device in air space behind weep holes.

END OF SECTION 04150

CMHC Best Practice Guide Brick Veneer/Concrete Masonry Unit Backing	MASONRY REINFORCING AND CONNECTORS	Section 04160 May 30, 1997 Page 1 of 1
---	---------------------------------------	--

PART 1 — GENERAL

- | | | |
|-------------------------------|----|---|
| 1.1 <u>Reference Standard</u> | .1 | Do masonry reinforcement to CSA A370-94, “Connectors for Masonry,” and A371-94, “Masonry Construction for Buildings,” unless specified otherwise. |
|-------------------------------|----|---|

PART 2 — PRODUCTS

- | | | |
|------------------------------------|----|--|
| 2.1 <u>Materials</u> | .1 | Wire reinforcement: to CSA A370-94 and CSA G30.3. |
| | .2 | Metal ties: to CSA A370-94. |
| | .3 | Bar-type reinforcement: to CSA A371-94, CSA G30.12-M77, Grade 400. |
| | .4 | Metal anchors: to CSA A370-94. |
| | .5 | Corrosion protection: to CSA A370-94 and CAN3-S304-M84 or S304.1-94 for metal ties and horizontal reinforcing in exterior walls. |
| 2.2 <u>Standard of Manufacture</u> | .1 | Horizontal reinforcing: hot-dipped, galvanized, ladder or truss type with box ties flush, welded every 400 mm (16 in.) on centre. See Structural Drawings for sizes. |

PART 3 — EXECUTION

- | | | |
|-------------------------|----|---|
| 3.1 <u>Installation</u> | .1 | Install masonry connectors and reinforcement in accordance with A370-94, A371-94, manufacturer’s recommendations, and as indicated. |
| | .2 | Spacing of horizontal reinforcing shall be as indicated on the drawings. |
| | .3 | Vertical reinforcing steel shall be placed in the centre of the core and not less than one bar diameter between bars. |
| | .4 | All block cores containing vertical reinforcement and/or anchor bolts shall be solidly filled with grout. |
| | .5 | Steel connections shall be inspected before grouting. |

END OF SECTION 04160

CMHC Best Practice Guide	BRICK MASONRY	Section 04210
Brick Veneer/Concrete		May 30, 1997
Masonry Unit Backing		Page 1 of 3

PART 1 — GENERAL

- | | | | | |
|-----|---------------------|----|---|---------------|
| 1.1 | <u>Related Work</u> | .1 | Masonry Procedures | Section 04050 |
| | | .2 | Mortar and Grout for Masonry | Section 04100 |
| | | .3 | Masonry Accessories | Section 04150 |
| | | .4 | Masonry Reinforcing and Connectors | Section 04160 |
| | | | | |
| 1.2 | <u>References</u> | .1 | CAN/CSA-A82.1-M87(R92), “Burned Clay Brick (Solid Masonry Units Made from Clay or Shale)” | |

PART 2 — PRODUCTS

- | | | | | |
|-----|-------------------|----|---|--|
| 2.1 | <u>Face Brick</u> | .1 | Burned clay brick: shall conform to CSA A82.1-M87(R92). | |
| | | .1 | Type: [FBX] [FBS] or [FBA]. | |
| | | .2 | Grade: [SW] [MW]. | |
| | | .3 | Size: modular metric. | |
| | | .4 | Colour and texture: []. | |
| | | .5 | Acceptable material: []. | |
| | | .2 | Calcium silicate brick: to CSA A82.3. | |
| | | .1 | Grade: [SW] [MW]. | |
| | | .2 | Size: modular metric. | |
| | | .3 | Colour and texture: []. | |
| | | .4 | Acceptable material: []. | |
| | | .3 | Concrete brick: to CAN3-A165 Series. | |
| | | .1 | Type: [I] [II]. | |
| | | .2 | Size: modular metric. | |
| | | .3 | Colour and texture: []. | |
| | | .4 | Acceptable material: []. | |

CMHC Best Practice Guide	BRICK MASONRY	Section 04210
Brick Veneer/Concrete		May 30, 1997
Masonry Unit Backing		Page 2 of 3

PART 3 — EXECUTION

- 3.1 Laying
 - .1 Bond: running stretcher or as indicated on drawings.
 - .2 Lay first course of brick at foundation wall in grey mortar. Lay subsequent courses using coloured mortar.
 - .3 Coursing height: 200 mm (8 in.) for three bricks and three joints.
 - .4 Jointing: concave and tooled where exposed.
 - .5 Mixing and blending: mix units within each pallet and with other pallets to ensure uniform blend of colour and texture
 - .6 Provide weep holes at 600 mm (24 in.) centres at all horizontal interruptions in the brick veneer.
 - .7 Unless noted otherwise on the drawings, provide movement joints at approximately 7 m (23 ft.) on centre for clay brick and 4 m (13.12 ft.) on centre for concrete brick. Seal face of joint with elastomeric sealant and foam backer rod.
 - .8 Wet clay bricks as stated in 3.6 of section 04050.

- 3.2 Cleaning
Unglazed
Clay Masonry
 - .1 Clean 10 m² (108 ft.²) area of wall designated by the Architect as specified below and leave for one week. If no harmful effects appear and after mortar has set and cured, protect windows, sills, doors, trim and other work, and clean brick masonry as follows:
 - .1 Remove large mortar particles with wood paddles without damaging surface. Saturate masonry with clean water and flush off loose mortar and dirt.

CMHC Best Practice Guide	BRICK MASONRY	Section 04210
Brick Veneer/Concrete		May 30, 1997
Masonry Unit Backing		Page 3 of 3

- | | | |
|---|-----------|--|
| <p>3.2 Cleaning Unglazed
Clay Masonry
<u>Cont'd</u></p> | <p>.2</p> | <p>Scrub with solution of 25 mL (1.5 in.³) trisodium phosphate and 25 mL (1.5 in.³) household detergent dissolved in 1 L (61 in.³) solution of clean water using stiff fibre brushes, then clean off immediately with clean water using a hose. Alternatively, use proprietary compound recommended by brick masonry manufacturer in accordance with manufacturer's directions.</p> |
| | <p>.3</p> | <p>Repeat cleaning process as often as necessary to remove mortar and other stains.</p> |
| | <p>.4</p> | <p>Use acid solution treatment for difficult-to-clean masonry as described in the latest edition of Technical Note No. 20, published by the Brick Institute of America.</p> |
| | <p>.5</p> | <p>Test acid cleaning method on designated area of wall, followed by a waiting period of at least one week, before proceeding with cleaning.</p> |

END OF SECTION 04210

CMHC Best Practice Guide	CONCRETE UNIT	Section 04220
Brick Veneer/Concrete	MASONRY	May 30, 1997
Masonry Unit Backing		Page 1 of 3

PART 1 — GENERAL

1.1 <u>Related Work</u>	.1	Masonry Procedures	Section 04050
	.2	Mortar and Grout for Masonry	Section 04100
	.3	Masonry Accessories	Section 04150
	.4	Masonry Reinforcing and Connectors	Section 04160
	.5	Air/Vapour Barrier Membrane	Section 07190
	.6	Board Insulation	Section 07210
1.2 <u>References</u>	.1	CAN3-A165-94, “CSA Standards on Concrete Masonry Units”	

PART 2 — PRODUCTS

2.1 <u>Materials</u>	.1	Standard concrete masonry units: to A165-94.
	.2	Classification: H/15/A/M.
	.3	Size: metric modular.
	.4	Special shapes: Provide purpose-made shapes for lintels and bond beams; provide square units for exposed corners.

PART 3 — EXECUTION

3.1 <u>Laying Concrete Masonry Units</u>	.1	Set masonry units in running bond and tooth bond at all intersections of walls and partitions.
	.2	Coursing height: 200 mm (8 in.) for one block and one joint.
	.3	Jointing: concave where exposed or where paint or other finish coating is specified. Where concealed, strike joints flush.

CMHC Best Practice Guide	CONCRETE UNIT	Section 04220
Brick Veneer/Concrete	MASONRY	May 30, 1997
Masonry Unit Backing		Page 2 of 3

- 3.1 Laying Concrete Masonry Units
Cont'd
- .4 Machine-cut all exposed masonry units that are adjusted in size.
 - .5 Carry all walls up to the underside of construction above and finish against underside of roof deck or floor slab above in accordance with details shown on the drawings. Leave [] mm space between block walls and any structure. Pack all voids between top of walls and structure with a 150 mm (6 in.) wide strip of semi-rigid glass fibre insulation.
 - .6 Cut and make good all openings or chases in new work required by other trades. Where conduits or pipes are in masonry work that is to be left exposed, take special care to ensure that final finish of masonry is presentable; secure the cooperation of other trades to ensure this result.
 - .7 Do not form chases in any bearing wall less than 240 mm (9.5 in.) thick or more than one-third the thickness of any wall of greater thickness and no closer to another chase than 2 m (6.6 ft.) except if shown otherwise on the drawings.
 - .8 Do not use horizontal chases.
 - .9 Build in sleeves as required.
 - .10 Build in conduits as required without breaking bond.
 - .11 Close masonry walls tightly around all penetrations that occur through them in ceiling spaces.
 - .12 At all openings in masonry walls, completely fill hollow units with grout at the jambs, and reinforce vertically as indicated on the drawings.
 - .13 Set bearing plates for joists, beams, etc., at locations and elevations indicated on the Structural Drawings.

CMHC Best Practice Guide	CONCRETE UNIT	Section 04220
Brick Veneer/Concrete	MASONRY	May 30, 1997
Masonry Unit Backing		Page 3 of 3

- 3.1 Laying Concrete Masonry Units Cont'd
 - .14 Provide temporary bracing of walls during and after erection until permanent lateral support is in place.
 - .15 Install sealant at joints within masonry work and where masonry work abuts other surfaces or materials.
 - .16 Do not wet concrete masonry units prior to use.
- 3.2 Concrete Masonry Lintels
 - .1 Concrete masonry lintels shall be installed over openings where steel or reinforced concrete lintels are not indicated. Fill all lintels with grout. Provide end bearing for all lintels as indicated on the drawings.
- 3.3 Movement Joints
 - .1 In concrete block walls, place movement joints as noted in drawings.
 - .2 Movement joints shall consist of a mortar key placed between the face shells of two adjacent blocks and filled to within 13 mm (0.5 in.) of the face. Separate mortar key from blocks by means of a paper liner. Seal face of joint.
- 3.4 Cleaning
 - .1 On unglazed concrete masonry to be left exposed, allow mortar droppings to partially dry then remove by trowel. Follow by rubbing lightly with small piece of block and finally by brushing.

END OF SECTION 04220

CMHC Best Practice Guide	AIR/VAPOUR BARRIER	Section 07190
Brick Veneer/Concrete	MEMBRANE	May 30, 1997
Masonry Unit Backing		Page 1 of 4

PART 1 — GENERAL

- 1.1 Related Work
 - .1 Cast-in-Place Concrete Section 03300
 - .2 Masonry Accessories Section 04150
 - .3 Concrete Unit Masonry Section 04220
 - .4 Board Insulation Section 07210
 - .5 Inverted Roofing Section 07550
- 1.2 Qualification
 - .1 Applicator: Company specializing in performing work of this section approved by materials manufacturers.
- 1.3 Environmental Requirements
 - .1 Do not install solvent curing sealants or vapour release adhesive materials in enclosed spaces without ventilation.
 - .2 Maintain temperature and humidity recommended by materials manufacturer’s before, during and after installation.
- 1.4 Sequencing
 - .1 Sequence work to permit installation of materials in conjunction with related materials and seals.
- 1.5 Coordination
 - .1 Coordinate work of this section with all sections referencing this section.
- 1.6 Warranty
 - .1 Provide a three-year warranty under provisions of Section 01410 and CCDC 2 Article GC 24 of the General Conditions.
 - .2 Warranty: Include coverage of installed sealant and sheet materials that fail to achieve an airtight and watertight seal, exhibit loss of adhesion or cohesion, or do not cure.

PART 2 — PRODUCTS

- 2.1 Sheet Materials
 - .1 Sheet seal type 1: self-adhesive rubberized asphalt bonded to sheet polyethylene, nominal total thickness of 1.0 mm (0.04 in.).
 - .2 Sheet seal type 2: thermofusible modified bitumen, nominal total thickness of [].

CMHC Best Practice Guide	AIR/VAPOUR BARRIER	Section 07190
Brick Veneer/Concrete	MEMBRANE	May 30, 1997
Masonry Unit Backing		Page 2 of 4

- 2.1 Sheet Materials .3 Sheet seal type 3: self-adhesive modified bitumen, nominal total thickness of [].
 Cont'd
- .4 Polyethylene: 0.075 mm (0.003 in.) thick polyethylene bonded to asphalt-treated crepe paper reinforced with 50 × 50 mm (2 × 2 in.) glass fibre scrim.
- 2.2 Sealants .1 Sealant type A: one-part thermoplastic rubber-based sealant compatible with sheet seal membrane as recommended by manufacturer.
- .2 Primer: recommended by sealant manufacturer, appropriate to application.
- .3 Substrate cleaner: non-corrosive, type recommended by sealant manufacturer, compatible with adjacent materials.
- 2.3 Adhesives .1 Mastic adhesive type 1: compatible with sheet seal and substrate, thick mastic of uniform consistency.
- 2.4 Accessories .1 Sheet seal primer: non-penetrating asphalt primer compatible with thermofusible grade membrane as recommended by manufacturer.
- .2 Sheet seal primer: synthetic rubber-based adhesive primer compatible with self-adhesive membrane as recommended by manufacturer.
- .3 Tape: rubberized asphalt bonded to polyethylene, self-adhering type, 100 mm (4 in.) and 150 mm (6 in.) wide, compatible with sheet material.
- .4 Attachments: galvanized steel bars and anchors.

PART 3 — EXECUTION

- 3.1 Examination .1 Verify that surfaces and conditions are ready to accept the Work of this section.

CMHC Best Practice Guide	AIR/VAPOUR BARRIER	Section 07190
Brick Veneer/Concrete	MEMBRANE	May 30, 1997
Masonry Unit Backing		Page 3 of 4

- 3.2 Preparation
- .1 Remove loose or foreign matter that might impair adhesion of materials.
 - .2 Clean and prime substrate surfaces to receive self-adhesive membranes, thermofusible membrane and sealants in accordance with manufacturer's instructions.
- 3.3 Installation
- .1 Install materials in accordance with manufacturer's instructions.
 - .2 Secure sheet seal type 1 and 3 to masonry materials by pressing firmly into place with a hand roller. Position lap seal over firm bearing. Provide minimum 50 mm (2 in.) side and end laps.
 - .3 Secure sheet seal type 2 to masonry materials with heat bonding. Position lap seal over firm bearing. Provide minimum 50 mm (2 in.) side and end laps.
 - .4 Lap sheet seal type 1 onto roof vapour retarder and seal with adhesive Type 1. Position lap seal over firm bearing. Lap minimum 100 mm (4 in.) onto roof air seal membrane and minimum 150 mm (6 in.) over wall seal material.
 - .5 Lap sheet seal type 3 onto roof vapour retarder and seal. Position lap seal over firm bearing. Lap minimum 100 mm (4 in.) onto roof air seal membrane and minimum 150 mm (6 in.) over wall seal material.
 - .6 Install sheet seal type 1 between window and door frames and adjacent wall seal materials with adhesive type 1. Position lap seal over firm bearing with 75 mm (3 in.) of full contact. Lap window and door frames with 25 mm (1 in.) of full contact.
 - .7 Install [sheet seal type 3] [polyethylene] between window and door frames and adjacent wall seal materials with sealant type A. Seal to ensure complete seal. Position lap seal over firm bearing with 75 mm (3 in.) of full contact. Lap window and door frames with 25 mm (1 in.) of full contact.

CMHC Best Practice Guide	AIR/VAPOUR BARRIER	Section 07190
Brick Veneer/Concrete	MEMBRANE	May 30, 1997
Masonry Unit Backing		Page 4 of 4

3.3 Installation .8 Apply sealant within recommended application
Cont'd temperature ranges. Consult manufacturer
when sealant cannot be applied within these
temperature ranges.

END OF SECTION 07190

CMHC Best Practice Guide	BOARD INSULATION	Section 07210
Brick Veneer/Concrete		May 30, 1997
Masonry Unit Backing		Page 1 of 3

PART 1 — GENERAL

- | | | | | |
|-----|-----------------------------|----|--|---------------|
| 1.1 | <u>Related Work</u> | .1 | Concrete Unit Masonry | Section 04200 |
| | | .2 | Brick Masonry | Section 04210 |
| | | .3 | Air/Vapour Barrier Membrane | Section 07190 |
| 1.2 | <u>Examination</u> | .1 | Examine surfaces to receive insulation and do not proceed with installation unless the underlying conditions are satisfactory. | |
| 1.3 | <u>Handling and Storage</u> | .1 | Store packaged materials in original undamaged containers with manufacturer's labels and seals intact. Deliver to site in sealed packages. | |

PART 2 — PRODUCTS

- | | | | | |
|-----|-------------------|----|--|--|
| 2.1 | <u>Insulation</u> | .1 | Extruded or expanded polystyrene: to CAN/CGSB-51.20, Type [1] [3], 2400 × [600] [400] × 75 mm square edges.
(8 ft. × [24 in.] [16 in.] × 3 in.) | |
| | | | OR | |
| | | .2 | Isocyanurate: | |
| | | .1 | Faced: to CAN/CGSB-51.26, type I, foil facing, flame spread classification: less than 25, 2400 × [600] [400] × 75 mm.
(8 ft. × [24 in.] [16 in.] × 3 in.) | |
| | | | OR | |
| | | .3 | Mineral fibre: to CSA A101, type 1, density 64 kg/m ³ , 2400 × [600] [400] × 75 mm.
(8 ft. × [24 in.] [16 in.] × 3 in.) | |
| | | | OR | |
| | | .4 | Fibrous glass: to CGSB 51-GP-10M, 2400 × [600] [400] × 75 mm.
(8 ft. × [24 in.] [16 in.] × 3 in.) | |
| 2.2 | <u>Adhesive</u> | .1 | Type A (for polystyrene): to CGSB 71-GP-24, type II. | |

CMHC Best Practice Guide	BOARD INSULATION	Section 07210
Brick Veneer/Concrete		May 30, 1997
Masonry Unit Backing		Page 2 of 3

- 2.2 Adhesive Cont'd .2 Type B: synthetic rubber base, solvent type, suitable for continuous application by trowel, fungi resistant, application temperature -12–50°C (11–122°F), compatible with insulation.
- .3 Type C: air/vapour barrier type, suitable for continuous application by trowel, fungi resistant, application temperature 5°C (41°F) minimum, permeance (3 mm wet film, to ASTM E96 method E) 2.2 ng/(Pa•s•m² s) (.037 perms), compatible with insulation.
- 2.3 Accessories .1 Insulation retainers: plastic or nylon wedge with rib-faced locking system compatible with masonry reinforcing.

PART 3 — EXECUTION

- 3.1 Workmanship .1 Install insulation after building substrate materials are dry.
- .2 Install insulation to maintain continuity of thermal protection to building elements and spaces.
- .3 Fit insulation tightly around all structural angles, penetrations and other protrusions.
- .4 Cut and trim insulation neatly to fit spaces. Butt joints tightly; offset vertical joints. Use only insulation boards free from chipped or broken edges. Use a size consistent with the module of the system.
- .5 Do not enclose insulation until it has been inspected and approved by the Architect.
- 3.2 Rigid Insulation Installation .1 Apply type A adhesive to [polystyrene] [mineral fibre] [fibrous glass] insulation board at rate of 1–2 m²/L (100 ft.²/0.16 ft.³), in accordance with manufacturer's recommendations.

CMHC Best Practice Guide	BOARD INSULATION	Section 07210
Brick Veneer/Concrete		May 30, 1997
Masonry Unit Backing		Page 3 of 3

- 3.2 Rigid Insulation Installation Cont'd
- .2 Apply type B adhesive to [Isocyanurate] [mineral fibre] [fibrous glass] insulation board at rate of 3 L/m² (1 ft.³/100 ft.²), in accordance with manufacturer’s recommendations.
 - .3 Install insulation boards on outer surface of backing wall on full bed of adhesive or full perimeter bead of adhesive.
 - .4 Apply type C adhesive to sheet air/vapour barrier membrane at rate of 3 L/m² (1 ft.³/100 ft.²), in accordance with manufacturer’s recommendations.
 - .5 Embed insulation boards into air/vapour barrier–type adhesive, applied as specified, prior to skinning of adhesive.
 - .6 Butter all butt joints except over movement joints with 3 mm (0.12 in.) film thickness of adhesive.
 - .7 Before adhesive dries, install with insulation retainers, one per veneer tie.
- 3.3 Movement Joints
- .1 For rigid insulation, create a continuous butt joint at all movement joints.
 - .2 Leave insulation board joints unbonded over line of movement joints.

END OF SECTION 07210

CMHC Best Practice Guide	METAL FLASHINGS	Section 07620
Brick Veneer/Concrete		May 30, 1997
Masonry Unit Backing		Page 1 of 3

PART 1 — GENERAL

- | | | | | |
|-----|---|----|--|---------------|
| 1.1 | <u>Related Work</u> | .1 | Masonry Accessories | Section 04150 |
| 1.2 | <u>Mock-Up</u> | .1 | Build mock-ups for each type of flashing and counter flashing, complete with all fasteners as per drawings and specifications and obtain Architect's approval prior to fabrication of any further metal flashings. | |
| 1.3 | Product Delivery, Storage and <u>Handling</u> | .1 | Deliver sheet-metal flashing materials to site and store in safe, protected storage area to prevent damage. | |
| | | .2 | Stack flashings to prevent twisting or bending out of shape. | |
| | | .3 | Prevent contact of flashing materials with corrosive substances. | |
| | | .4 | Damaged materials shall be replaced with new materials. | |
| | | .5 | Handle and store metal flashings so that marring and scratching of the coatings do not occur. | |
| 1.4 | <u>Guarantee</u> | .1 | Guarantee flashing assembly free of following defects: splitting seams, lifting, loosening and undue expansion for two years from date of substantial performance. | |

PART 2 — PRODUCTS

- | | | | | |
|-----|------------------|----|--|--|
| 2.1 | <u>Materials</u> | .1 | <u>Metal Flashings</u> | |
| | | | Galvanized steel, 0.45 mm (26 ga.) core nominal thickness, Z275 zinc coating designation, to ASTM A525M-80, prefinished to CGSB 93-GP-3M, Class FIS. | |
| | | | Colour to the Architect's later choice from manufacturer's standard range. | |

CMHC Best Practice Guide	METAL FLASHINGS	Section 07620
Brick Veneer/Concrete		May 30, 1997
Masonry Unit Backing		Page 2 of 3

2.1 Materials Cont'd .2 Cleats and Fasteners

Cleats and fasteners shall be of the same material as the metal they are designed to secure. Size shall be to suit components to be secured. Gauge shall be sufficient to retain the flashings in place.

.3 Nails

Hot-dipped galvanized steel, spiral thread, of sufficient length to provide a minimum 25 mm (1 in.) penetration into substrate.

.4 Plastic Cement

Plastic cement for caulking and bedding flashings shall conform to CGSB 37-GP-5M.

.5 Bituminous Paint

Bituminous paint shall conform to CGSB 1-GP-108, type II.

PART 3 — EXECUTION

- 3.1 Workmanship
- .1 Metal flashing shall be as detailed, supplemented by recommendations of Canadian Roofing Contractors' Association Specifications.
 - .2 All free edges of metal flashing shall be strengthened by a fold at least 13 mm (0.5 in.) wide, set out slightly and presenting a straight line and a neat finish.
 - .3 Form flashings in 2400 mm (8 ft.) lengths whenever possible. Make allowance for expansion at joints.

CMHC Best Practice Guide	METAL FLASHINGS	Section 07620
Brick Veneer/Concrete		May 30, 1997
Masonry Unit Backing		Page 3 of 3

- | | | | |
|-----|-------------------------------------|----|---|
| 3.1 | <u>Workmanship</u>
<u>Cont'd</u> | .4 | End joints where adjacent lengths of metal flashing meet shall be made using an “S-lock” joint. This shall be executed by inserting the end of one coping length in a 25 mm (1 in.) deep S-lock formed in the end of the adjacent length in a full bed of caulking compound. Concealed portion of the S-lock shall extend 25 mm (1 in.) outward and be nailed to the substrate. Face nailing of the joints will not be permitted. |
| | | .5 | The metal shall be formed on a bending brake. Shaping, trimming and hand seaming shall be done on the bench as far as is practicable with the proper sheet-metal working tools. The angle of the bends and the folds for interlocking the metal shall be made with full regard to expansion and contraction to avoid buckling or fullness in the metal after it is in service and to avoid damaging the surface of the metal. |
| | | .6 | Install continuous starter strips where indicated or required to present a true, non-waving, leading edge. Anchor to back-up to provide rigid, secure installation. |
| | | .7 | Apply isolation coating to metal surfaces to be embedded in concrete or mortar. |
| | | .8 | Mitre and seal corners with sealant. |
| 3.2 | <u>Counter</u>
<u>Flashings</u> | .1 | Install counter flashings as soon as possible after membrane flashings are in place. |
| | | .2 | Counter flashings shall have a folded, bottom-edge, stiffening break where indicated, and shall extend up vertical face of wall or curb to height shown, then be turned into reglets or interlocked with cap flashings. |
| | | .3 | Wedge flashings into reglets and caulk neatly using specified sealant. |
| 3.3 | <u>Cap Flashings</u> | .1 | Tops of walls, parapets, counter flashings and the like shall be cap flashed as detailed, after membrane and metal counter flashings are in place. |

END OF SECTION 07620

CMHC Best Practice Guide	SEALANTS	Section 07900
Brick Veneer/Concrete		May 30, 1997
Masonry Unit Backing		Page 1 of 4

PART 1 — GENERAL

- 1.1 Guarantee .1 Provide a written guarantee, signed and issued in the name of the Owner, stating that caulking work of this section is guaranteed against leakage, cracking, crumbling, melting, shrinkage, running, loss of adhesion, or other failure, staining adjacent surfaces, for a period of three years from the date of Certificate of Substantial Performance.

- 1.2 Product Delivery, Storage and Handling .1 Deliver and store materials in original wrappings and containers with manufacturer’s seals and labels intact. Protect from freezing, moisture and water.

- 1.3 Environmental and Safety Requirements .1 Comply with requirements of Workplace Hazardous Materials Information System (WHMIS) regarding use, handling, storage and disposal of hazardous materials; and regarding labelling and provision of material safety data sheets acceptable to Human Resources Development Canada.
 - .2 Conform to manufacturer’s recommended temperatures, relative humidity and substrate moisture content for application and curing of sealants including special conditions governing use.
 - .3 [Architect will arrange for ventilation system to be operated on maximum outdoor air and exhaust during installation of caulking and sealants.] [Ventilate area of work as directed by Architect by use of approved portable supply and exhaust fans.]

PART 2 — PRODUCTS

- 2.1 Sealant Materials .1 Sealants: shall conform to CGSB specifications as listed below; colour to Architect’s selection.
 - .1 Type 1: Multi-component, epoxidized polyurethane terpolymer sealant. To meet specified requirements of CGSB Specification CAN2.19-24-M90. Use at all locations, except where another type is specified.

CMHC Best Practice Guide	SEALANTS	Section 07900
Brick Veneer/Concrete		May 30, 1997
Masonry Unit Backing		Page 2 of 4

- | | | | |
|-----|---------------------------------|----|---|
| 2.1 | <u>Sealant Materials Cont'd</u> | .2 | <p><u>Type 2</u>: One part elastomeric sealants: to meet specified requirements of NSC/CGSB Specification CAN2-19.13 M87.</p> <p>.1 Classification MC-2-25-B-N moisture-curing hybrid polyurethane. Use at curtain wall joints; perimeter caulking of windows, doors and panels; bedding for mullions, panels and frames.</p> <p>.2 Classification MCG-2-25-A-L medium modulus silicone, to be used in glass-to-glass, glass-to-metal, and metal-to-metal joints.</p> |
| 2.2 | <u>Back-up Materials</u> | .1 | <p>Polyolefin, polyethylene, urathane, neoprene or vinyl foam</p> <p>.1 Extruded closed cell foam backer rod.</p> <p>.2 Size: oversize 30–50%.</p> <p>.3 Chemically compatible with primers and sealants.</p> <p>.1 Round solid rod, Shore A hardness 70.</p> <p>.2 Bond breaker tape</p> <p>.1 Polyethylene bond breaker tape which will not bond to sealant.</p> |
| 2.3 | <u>Joint Cleaner</u> | .1 | <p>Non-corrosive and non-staining type, compatible with joint forming materials and sealant recommended by sealant manufacturer.</p> |
| 2.4 | <u>Primer</u> | .1 | <p>Primer: as recommended by manufacturer.</p> |

PART 3 — EXECUTION

- | | | | |
|-----|-----------------------|----|--|
| 3.1 | <u>Extent of Work</u> | .1 | <p>Install sealants in all locations shown on drawings.</p> <p>.2 Install sealant at the perimeter of all exterior openings where doors, windows, grilles and other items abut or penetrate the exterior wall materials.</p> |
|-----|-----------------------|----|--|

CMHC Best Practice Guide	SEALANTS	Section 07900
Brick Veneer/Concrete		May 30, 1997
Masonry Unit Backing		Page 3 of 4

- 3.1 Extent of Work Cont'd
 - .3 At all door saddles spread a bead of sealant compound over entire seat of saddles at least 3 mm (0.12 in.) thick before installing saddle.
 - .4 Seal the junctions of differing exterior wall materials.
 - .5 Provide a minimum of two continuous beads of sealant under all pre-finished galvanized steel wall flashings.

- 3.2 Preparation of Joint Surfaces
 - .1 Examine joint sizes and conditions to establish correct depth-to-width relationship for installation of back-up materials and sealants.
 - .2 Clean bonding joint surfaces of harmful matter substances including dust, rust, oil, grease and other matter that may impair work.
 - .3 Do not apply sealants to joint surfaces treated with sealer, curing compound, water repellent or other coatings, unless tests have been performed to ensure compatibility of materials. Remove coatings as required.
 - .4 Ensure joint surfaces are dry and frost-free.
 - .5 Prepare surfaces in accordance with manufacturer's directions.

- 3.3 Priming
 - 1 Where necessary to prevent staining, mask adjacent surfaces prior to priming and sealing.
 - .2 Prime sides of joints in accordance with sealant manufacturer's instructions immediately prior to sealing.

- 3.4 Back-up Material
 - .1 Apply bond breaker tape where required to manufacturer's instructions.
 - .2 Install joint filler to achieve correct joint depth and shape.

- 3.5 Mixing
 - .1 Mix materials in strict accordance with sealant manufacturer's instructions.

- 3.6 Application
 - .1 Sealant:

CMHC Best Practice Guide	SEALANTS	Section 07900
Brick Veneer/Concrete		May 30, 1997
Masonry Unit Backing		Page 4 of 4

3.6 Application
Cont'd

- .1 Apply sealant in accordance with manufacturer's instructions.
- .2 Apply sealant in continuous beads.
- .3 Apply sealant using gun with proper size nozzle.
- .4 Use sufficient pressure to fill voids and joints solidly.
- .5 Form surface of sealant with full bead, smooth, and free from ridges, wrinkles, sags, air pockets, embedded impurities.
- .6 Tool exposed surfaces to give slightly concave shape.
- .7 Remove excess compound promptly as work progresses and on completion.

.2 Curing:

- .1 Cure sealants in accordance with sealant manufacturer's instructions.
- .2 Do not cover up sealants until proper curing has taken place.

.3 Clean-up:

- .1 Clean adjacent surfaces immediately and leave work neat and clean.
- .2 Remove excess and droppings, using recommended cleaners as work progresses.
- .3 Remove masking tape after initial set of sealant.

END OF SECTION 07900

INTRODUCTION

Architects and engineers generally do not specify the sequence of construction. The sequence of putting together the various elements of a building is the responsibility of the contractor. In some ways, this sequence is obvious from the design drawings and specifications. For a multitude of reasons, however, the obvious sequence cannot or is not always followed on site. To improve on buildability and to help ensure the long-term performance of the wall system, simplicity and flexibility for change and resequencing should be inherent in the system and interface design. The designer should try to appreciate the effects of interfacing details, sequencing and component position on other components that precede or follow in the construction sequence.

This chapter reviews some of the on-site difficulties in the construction of the brick veneer/CMU wall system, all of which can usually be avoided:

- through an understanding of building and masonry construction interfacing and sequencing, with appropriate design details to reflect this understanding;
- by specifying components and systems that facilitate adjustment in plan and in elevation; and
- through quality-assurance, including appropriately sequenced and coordinated management, quality control, communication between all parties, and expedient implementation of corrective action, where required.

SEQUENCING

The following components are built into a brick veneer/CMU cavity wall:

- ① • masonry ties and reinforcing
 - concrete block back-up
 - foundation-level flashing
 - masonry connectors for lateral support
- ② air space cavity
- ③ air/vapour barrier
- ④ insulation
- ⑤ • exterior brick wythe
 - lintel flashing
 - shelf angles and lintels over openings
 - openings
- ⑥ • joints and junctions
- ⑦ parapet cap flashing
- ⑧ interior finishes

The circled numbers indicate the sequence of construction of a modern brick veneer/CMU wall system; some components are built concurrently.

With the earlier forms of cavity-wall construction, both the inner and outer wythes were built concurrently. This is no longer the case.

CONCRETE BLOCK BACKING

Locating concrete foundation walls and other supporting elements indiscriminately in plans and elevations can cause difficulties in the layout and appropriate placement of the masonry wall system. As-built construction must satisfy the permissible construction tolerances, stated in the appropriate CSA Standard. Failure by any trade to adhere to these tolerances, and proceeding with work despite non-compliance of any preceding work, can ultimately influence the structural and environmental performance of the wall system. On the issue of masonry tolerances, CSA Standard A371-94 assigns responsibilities both to the designer and to the contractor for design, layout and construction. (See the discussion in Chapter 2, under “Design Width and Constructed Width.”)

When vertical reinforcement is cast into the foundation or supporting slab, it is rarely accurately located in the plan as normal to the wall or along the axis of the wall. Cutting blocks and bending, cutting and replacing the rebar are often subsequently demanded. It is generally agreed that it is ultimately more cost-effective and expeditious on many projects, depending on quantity and difficulty of layout, to drill and grout reinforcement at the time of masonry wall layout, rather than casting in well before the arrival of the mason on the job site.

Dovetail anchor slots in concrete elements abutting the masonry should be in place at the correct location when casting the concrete. For various reasons, however, they are frequently omitted by the general contractor or are sometimes incorrectly placed. In either case, well before the masonry work begins, the designer and contractor should discuss the appropriate selection of an alternative anchor.

The design of lateral supports along the top and sides of the inner block wythe deserves attention. The configuration and method of attachment depend on the following issues:

- whether the masonry is load-bearing or non-load-bearing; and
- whether the connection must be concealed within the block wall, may be concealed by ceiling finish or other such surfaces, or may be exposed and visible.

In nearly all cases, it is inappropriate to install the lateral supports before the masonry work. Installation should be either concurrent with or subsequent to the masonry work to ensure positioning, alignment and positive contact between the supports and the masonry wall.

AIR/VAPOUR BARRIER IN CAVITY

For embedded tie systems, remedial work to rectify missing or misplaced ties takes place after the installation of the air/vapour sheet membrane, done by surface mounting and mechanical fixing. Thus, inspection can wait until after the installation of the sheet membrane. However, early in the project, the inspector should verify that the tie type, frequency of placement and position accord with the plans and specifications, the recommendations provided by the tie manufacturer, and the interfacing requirements for the sheet membrane and insulation widths.

At junctions of trade interfaces (e.g., foundation-wall, fenestration-wall, roofing-wall), preceding work should include providing a width of (generally unadhered) membrane, sufficient to permit lap splice and continuance of an integral air barrier system.

The air barrier should be installed flawlessly. Therefore, it is strongly recommended that air leakage testing, if it is to be conducted, be performed before the exterior wythe is in place to ensure that flaws are more readily detected and that deficiencies can be more easily corrected. Clearly, before testing, all penetrations through the air barrier must be made and sealed. Using ties embedded in the block backing and sealed at the time of application of the air barrier facilitates this test sequence; surface-mounted ties installed over and penetrating the air barrier, which are best installed concurrent with the building of the exterior wythe, will not facilitate this test sequence.

INSULATION

Taking the following measures facilitates placement of the insulation:

- coordinating tie spacing with sheet-insulation widths
- selecting an insulation with appropriate stiffness
- selecting an appropriate fastening system that accommodates the anticipated offsets, in-plane variations and inconsistencies in the surface of the backing, so that the insulation can be installed in intimate contact with the air/vapour barrier sheet membrane, and remain so
- selecting an appropriate design width of cavity and air space, thereby accommodating reasonably foreseeable construction tolerances

Cavity insulation should not be secured on the wall too far in advance of constructing the exterior wythe, or it becomes difficult to avoid damage from weathering and accidental impact during construction.

As with the air/vapour barrier system, it is strongly recommended that inspection or testing of the thermal system be performed before the exterior wythe is in place to detect flaws more readily and correct deficiencies more easily.

EXTERIOR MASONRY WYTHER

The elevation of the coursing for the exterior masonry wythe should be gauged from the supporting element (shelf angle, foundation) to ensure the best alignment with wall penetrations and fenestration. Plan position from grid to the face of the wythe should be in accordance with the drawings, but it is frequently (and often necessarily) tempered by the mason to facilitate alignment with the work that preceded the masonry work (such as the positioning of fenestration and the structural frame). The contractor must be mindful of the permissible construction tolerances, assigned by CSA Standard A371, and the permissible adjustments afforded by the masonry-tie system. Before proceeding with work, the contractor is obligated to inform the designer of places where tolerances cannot be maintained.

Preceding work must be protected if it is susceptible to damage from accidental impact, mortar droppings and masonry cleaning.

FLASHINGS

Like cavity insulation, flashings should not be secured on the wall too far in advance of constructing the exterior wythe, or again it becomes difficult to avoid damage from weathering and accidental impact during construction.

Flashings must be positioned after installation of the air/vapour barrier membrane but before, and in some cases concurrent with, the placement of insulation, which is often used to support the flashings across the air space.

As with the air/vapour barrier system, it is strongly recommended that inspection of flashings be performed before the exterior wythe is in place to detect flaws more readily and correct deficiencies more easily.

SHELF ANGLES AND LINTELS

Building investigations have shown that the positioning of shelf angles is critical to the long-term structural and environmental performance of the masonry wall system. It is extremely important that the shelf angle be level and be accurately positioned in plan and in elevation to allow the mason to maintain gauge and coursing, to provide a uniform and continuous movement joint below the angle, and to construct the exterior wythe with sufficient bearing support and an acceptable width of air space.

To accurately locate the shelf angle, it helps to detail a support system that permits in-situ adjustment of the angle, vertically and normal to the wall, without excessive shimming or cutting of steel. The sequencing of the shelf angle installation and setting of the exterior masonry wythe should be carefully coordinated between the steel and masonry contractors to ensure buildability and to minimize the need to reposition shelf angles.

In general, to ensure the continuity and integrity of the air and thermal systems, the installation of the shelf angle should precede the placement of the air barrier membrane and the insulation.

JOINTS AND JUNCTIONS

Building investigations reveal that a good proportion of envelope failures can be traced back to inappropriate interfacing of work by different trades, either through poor or non-existent detailing at the design stage, or failure to coordinate, inspect or correct completed work at the interface. The designer, contractors and inspectors must give special attention to joints and junctions.

BID DOCUMENT REVIEW

The following steps are recommended for all parties to gain a firm understanding of the impact of component quality and installation on the performance of adjacent components and assemblies and the building envelope system:

- Throughout the course of construction, as each of the principal sub-trades arrives, preconstruction meetings should be held with the designer, general contractor and tradespeople. The designer should discuss the intended functions of each component and assembly, review the critical aspects of the design, and explain what effect any deviation from the acceptable quality will have on the work by each trade, and on the performance of the system as a whole.
- A suitably sized mock-up should be built containing all components, assemblies and interfaces. Have it reviewed, and have all trades confirm their sequencing before project work begins. (See Chapter 7 for more information.)

QUALITY

The following are definitions of quality for the principal parties involved in construction:

- Owner – Quality to an owner means that the construction is fit for the intended purpose, within the agreed budget.
- Designer – Quality for a designer is conformance to the requirements of the owner, the appropriate building codes and the prevailing state of the art.
- Contractor – Quality for a contractor is strict adherence of construction to plans and specifications.
- Inspector – Quality for an inspector is judging as accurately as possible the adherence of the contractor to the standards established in the plans and specifications.
- Facilities management – Quality for facilities management personnel is acceptable and predictable building performance.

RESPONSIBILITIES

The road to quality starts with the owner. The owner should provide the designer with the following expectations:

- intended purpose of the building
- life span of building components
- maintenance levels acceptable to the owner
- construction cost budget consistent with the above expectations

The responsibility for providing this information rests with the owner.

The designer then defines, through drawings and specifications, the intended quality of the finished building needed to meet owner expectations. The designer should ensure that drawings and specifications are in accordance with the requirements of the following:

- building codes
- current best practice
- the agreed-to budget
- the owner's expectations

The drawings convey quantity and specifications convey to the contractor the quality of the product that the owner expects. The responsibility for the quality of this information rests with the designer.

The responsibility for constructing the building in accordance with the plans and specifications rests with the contractor. The contractor should have systems in place to accomplish the following:

- enforce work compliance with drawings and specifications
- report changes and seek approval of changes from the designer, prior to carrying out work, when compliance is impossible
- coordinate, schedule and define the roles of the tradespeople involved in the construction

QUALITY CONTROL AND QUALITY ASSURANCE

QUALITY CONTROL

The techniques and activities used to ensure that the work fulfils requirements for quality constitute quality control. For example, testing materials and inspecting installation are quality control measures.

QUALITY ASSURANCE

All planned and systematic actions needed to ensure adequate confidence that a product or service will satisfy given requirements for quality constitute quality assurance. See “Steps for Quality Assurance.”

Quality assurance must begin at the start of the project; quality cannot be obtained after the work is complete. If the completed work is substandard, there are three options:

- Accept the substandard product.
- Repair it.
- Replace it.

In building construction, once a particular element is built, replacing it is usually not an option. The other two options are usually potentially detrimental to the project. It is therefore essential that a system for quality control be established right at the start of an activity and maintained through to the end to achieve the desired quality.

INSPECTION

Inspection refers to the review of work to determine whether it meets the standards. Those standards are detailed in the plans and specifications. Inspection may include the following:

- visual observation of material or methods
- quantity measurement
- testing of material properties
- testing of assemblies
- review of quality assurance procedures

Architects and engineers usually avoid the word “inspection” because it implies legal responsibilities beyond those most architects, engineers or their insurers can accept. Architects and engineers use the term “review.” Review is carried out periodically to determine whether construction generally conforms with drawings and specifications.

Various types of inspectors visit a construction site, with different types and levels of responsibility (e.g., designer’s inspector, contractor’s inspector). The role of each inspector should be made clear to all parties.

The duty of the designer’s inspector is to visit the site periodically, to review the work and bring any noted deficiencies to the attention of the contractor and the owner. The designer’s inspector does not *ensure* that the work is carried out in accordance with plans and specifications.

The owner may engage a specialist or retain the designer's inspector full-time to provide inspection over and above the general review provided by the designer.

The duty of the contractor's inspector is to review work daily and receive comments from the designer's and owner's inspectors to ensure that deficiencies are corrected as the work proceeds.

STEPS FOR QUALITY ASSURANCE

1. Construction drawings and specifications should clearly show the location, materials and standards of workmanship for the assembly.
2. Any special or extraordinary details should be discussed with an experienced contractor to ensure that the details are buildable.
3. The specifications should include requirements for mock-ups of the work of each trade, incorporating repetitive details before the work commences. These should be discussed to ensure that potential difficulties and problems are resolved before undertaking large-scale construction. The need for cooperation among specific trades becomes evident in such an exercise. Mock-ups, whether incorporated into the final work or not, set the standard of quality against which all subsequent work will be judged. The accepted mock-ups should be retained for reference.
4. The specifications should include requirements for submission of samples for review, prior to ordering materials. Once a sample is found acceptable, it is kept on site for reference and for comparison with the delivered material.
5. The specifications should require submission of shop drawings for items that interrupt or tie into the brick veneer/concrete block back-up cavity wall, such as building structure, doors, windows, and alternate claddings. These drawings should show how the junction will be constructed. The inspector(s) should confirm that applicable shop drawings are reviewed expeditiously and verify that the contractor is working with reviewed drawings.
6. Before starting construction, a preconstruction meeting should be held to review the following:
 - inspection and testing procedures
 - submission of shop drawings
 - construction sequencing and coordination of trades
 - timing of inspections
 - contractor's methods of quality control
 - construction of mock-up
 - submission of samples
7. The inspector(s) should provide confirmation of all permits and inspections needed for compliance with local, regional, provincial and federal regulations. Inspectors should be aware of the pertinent aspects of all applicable codes and ensure that construction is proceeding in accordance with them.
8. For any inspection or testing required by contract, the inspectors must ensure that arrangements are made at the appropriate time, that the representatives of the testing companies are on site when required to carry out the tests, and that the test results are reported expeditiously.

9. The contractor's inspector should review the work every day and ensure that the standards of quality set out in the contract documents, including addenda, change orders and site instructions, are maintained. The owner's inspector is expected to visit the site periodically to review the construction. Any deficiencies observed should be pointed out in writing to the contractor and the owner. The contractor's inspector must ensure that deficiencies pointed out by the owner's inspector are corrected. The owner's inspector should then review the previously discovered deficiencies for evidence that they have been corrected.

BRICK FACING/CONCRETE BLOCK BACKING WITH CAVITY: SITE INSPECTION CHECKLIST

The following is a general checklist; specific designer and builder checklists are provided with each detail in Chapter 5.

GENERAL

- Read the specifications.
- Study the drawings and details.
- Review applicable code requirements.
- Check that required permits have been obtained.

MATERIALS

- Approve sample(s).
- Inspect materials on delivery for compliance with specifications.
 - Check that masonry units are the right size, colour and texture and that they are clean, undamaged and dry.
 - Check mortar and grout ingredients, on delivery, to assure compliance with the mix(es) specified. Reject bagged ingredients showing signs of water absorption.
 - Check ties, reinforcing steel and lintels for compliance. (Steel should be identified for its location in the building and carry certification of yield strength.)
 - Check that the insulation has the specified thermal resistance.
- Establish mixing and batching procedures for mortar and grout at the outset. (Any required testing is to be done before construction begins to allow for changes or modifications.)
- Approve mock-up(s).
- Check storage, handling and protection of materials to ensure that applicable standards are met and that damage to materials is prevented.

CONSTRUCTION

- Inspect substrates for the following requirements:
 - proper size, location, grade, lines, levels and tolerances
 - cleanliness
 - adequate structural support for new work
- Check locations of steel reinforcing dowels in relation to the wall.
- Log weather conditions affecting performance or progress.
- Ensure that the tradespeople are working together and recognizing each other's requirements.
- Before each trade starts work, examine the work on which the new work depends. (Any required corrective work should be done before the new work begins. Check that a qualified representative of the trade accepts the previous work.)

WORKMANSHIP

- At the start of masonry work, inspect the following:
 - proper layout and horizontal coursing and
 - laying procedures, including ensuring the following:
 - full head and bed joints
 - no movement of masonry units, once placed
 - units shoved and tapped into position
 - mortar spread no more than 1200 mm (4 ft.) in front of laying (less on a hot day)
 - wall plumb and level
 - conformance with sample panel
 - mortar kept off the face of the masonry (no slushing of head joints)
 - properly tooled joints and proper timing
 - vertical coursing and joint uniformity
 - proper embedment and coverage of anchors, ties and joint reinforcement
- For the wall with cavity, ensure the following:
 - The cavity is the correct width and has the specified tolerances.
 - The cavity is kept reasonably clear of mortar fins and droppings.
 - Flashing and weep holes are in place at the bottom of the cavity and weep holes are free of mortar.
 - Ties and reinforcing are of the proper type and are correctly located and positioned.
 - Cavity insulation is installed continuously, securely and in full contact with block wall.
 - Air and vapour barrier materials are installed continuously and have the specified thickness.
- Ensure that incomplete walls have been stepped.
- Ensure that the work of other trades is incorporated.
- Check that the mortar type is correct and that the mortar is mixed according to the manufacturer's instructions.
- Ensure that the mortar is retempered within permissible times and other limits, and that spent mortar is discarded.
- Ensure that masonry units that will remain exposed to view are cut with a masonry saw.

- Check that flashing terminations are watertight and that flashings are continuous.
- Ensure that flashings, control and expansion joints, lintels, sills, caps, copings, and frames are properly incorporated and that movement joints are free of mortar.
- Ensure that masonry anchors to the structure allow vertical and horizontal movement where required.
- Ensure that horizontal joint reinforcing is cut and continuous where appropriate, and that joints are lapped.
- Inspect structural reinforcing for the following:
 - freedom from rust, loose scale and other impurities that could impair bond
 - proper size and location
 - conflicts between joint reinforcing and structural reinforcing or architectural details
- Inspect cavities or cores to be grouted to ensure they are free of dirt, debris, droppings or protrusions.
- Inspect grout consistency.
 - Verify that the rodding is done immediately after the pour, to remove air bubbles and pockets. If grout lift is greater than 300 mm, use small-diameter pencil-type internal vibrators. Reconsolidate the mix if excessive water is absorbed, before the grout's plasticity is lost.

PROTECTION AND CLEANING

- Ensure that materials are protected from weather and damage from adjacent or subsequent work. (Materials should be off the ground and draped in waterproof coverings.)
- Check that unfinished walls are draped over the top at the end of the work day.
- Ensure that cold- or hot-weather construction procedures are followed.
- Check that mortar is removed from the face of units before it hardens.
- Ensure that proper cleaning agents are used.
- Check that the site is maintained daily in a clean condition to ensure the highest standards of workmanship, as well as greater efficiency and fewer accidents.

INTRODUCTION

Commissioning is the process of verifying the performance of a completed system, to determine whether it complies with the design documents and specified performance criteria. Commissioning commonly occurs at the completion of a building project, to verify the performance of some mechanical and electrical equipment.

The concept of commissioning a building envelope is very recent. This chapter was adapted from the CMHC report *Commissioning and Monitoring the Building Envelope for Air Leakage*, published in November 1993.

This report suggests that the commissioning of a building envelope should start with the appointment of a commissioning agent, at the project brief stage. The commissioning agent may be the architect for the project or a building envelope consultant.

IMPLEMENTATION OUTLINE

The following is a proposed outline of steps in the commissioning of a building envelope:

1. The owner appoints a consultant to prepare the project brief.
2. The owner appoints a commissioning agent to prepare the performance criteria for the building envelope, which forms a part of the project brief.
3. The owner appoints the design team to start work on the working drawings, based on the project brief.
4. The commissioning agent offers guidance to the design team in understanding the performance criteria and carries out the design validation of the building envelope details.
5. The commissioning agent completes an audit of the building envelope design, which determines whether the building envelope elements, if constructed in accordance with the design details, will in combination satisfy the performance criteria set out in the design brief.
6. The commissioning agent ensures that performance criteria of the building envelope are made a part of the tender documents.
7. The commissioning agent obtains building envelope certification during construction and final commissioning.
8. Post-commissioning operation, maintenance and repair.

BENEFITS OF THE COMMISSIONING PROCESS

It is hoped that commissioning the building envelope will have the following benefits for the owner, the occupants and the design team:

- improved performance of the building envelope, resulting in savings in energy and maintenance of the building envelope
- improved occupant comfort
- improved performance of the mechanical and electrical systems, resulting from improved building envelope performance, which in turn can reduce operating and maintenance costs, and increase life cycles
- reduced exposure of the design team to liability for errors or omissions, because commissioning may improve design and construction

IMPLEMENTATION DETAILS

PROJECT BRIEF

Building envelopes in this best practice guide have the following components:

- brick veneer
- air cavity
- insulation
- block back-up
- masonry connectors and ties
- air/vapour barrier
- windows

The project brief should contain the following information about the building envelope:

- exterior design conditions
- interior design conditions
- summer and winter temperature and humidity requirements
- type of exterior wall system
- maximum air leakage permitted through the different envelope components
- average thermal resistance of the envelope
- durability and life span of the components
- maintenance expectations of the owner

DESIGN PROCESS

The following additional steps are recommended in the design process:

- validation of the design of the components of the envelope for strength, durability, thermal resistance, air and water impermeability, and continuity of the air and thermal envelope
- an audit at the conclusion of the design stage to determine whether the as-built details will substantially satisfy the performance criteria stated in the project brief

The validation and audit are needed to provide proof to the contractor that the details shown, if built properly, will satisfy the performance requirements.

TENDER DOCUMENTS

Compliance criteria, including method of test and quantified performance levels, must be specifically stated in the tender documents. The following four options are suggested:

Option 1

The total envelope will be tested after substantial completion for air leakage, structural performance of the air barrier, discontinuities in the thermal barrier, and water leakage. If deficiencies are found in meeting the prescribed limits, then these must be investigated by the builder and repaired at no cost to the owner. Test procedures must be as follows:

- as described in CAN/CGSB2- 149.10-M85 “Determination of Airtightness of Building Envelopes by the Fan Depressurization Method”
- thermographic scan
- testing for water leakage

Option 2

After each area in the envelope is substantially completed, the envelope will be tested to determine air leakage, structural performance of the air barrier, thermal barrier discontinuities and water leakage. Once an envelope assembly has been tested, it need not be tested in every area, as long as construction reviews certify that other areas are constructed to the same standard of quality. After substantial completion, the whole building will be tested in accordance with Option 1.

Option 3

The building envelope will be tested by testing an on-site mock-up. The construction of the mock-up will be described in the architectural drawings. Only if the air and water leakage and the structural performances of the air and thermal barriers conform to the prescribed criteria, can construction proceed. The construction should closely follow the quality of the mock-up. If the performance of the mock-up fails to meet the requirements, the quality of mock-up construction must be improved to meet the performance criteria before building construction can begin.

Option 4

This option includes the details of options 2 and 3. In addition, it requires that site briefings be held at the pre-tender stage, before construction start-up, to explain to the construction team the following:

- design objectives
- performance requirements
- need for performance requirements
- types and timing of tests to be conducted
- acceptable levels of quality
- role and responsibilities of the commissioning agent

CONCLUSION

These procedures have not been used in their entirety on any project. Each project must be carefully examined for the merit and feasibility of the commissioning process. Further work is under way, and it is hoped that a case study of a high-rise building will be available in the near future.

MAINTENANCE

Brick veneer/concrete block back-up cavity walls require very little maintenance if they are properly designed and constructed. However, maintenance is required for the many components of the wall that have shorter life expectancies and maintenance cycles than brick or concrete block. Table 9.1 shows the estimated life expectancies of materials exposed to normal weathering.

Table 9.1: Estimated Service Life of Related Materials and Systems

Item	Estimated Life in Years
Wall masonry	100 or more
Exterior sealants	5–10
Mortar	25 or more
Coping and flashing	20–40
Windows	25 or more
Ventilation louvres	20–30
Air barrier sealants	15–25
Brick sills and copings	5–15

Maintenance of masonry construction ensures that the materials and systems are kept in a condition to perform as designed. Some examples of maintenance are the following:

- repointing mortar joints
- replacing or repairing sealants at flashings, movement joints, windows, doors, louvres and joints between dissimilar materials
- repairing flashings
- repairing or replacing windows and doors
- replacing or repairing air/vapour barrier sealants, where accessible

GENERAL INSPECTION

A thorough inspection and maintenance program is recommended because it is an inexpensive way to extend the life of a building. The inspector should first become familiar with the existing construction. The inspector may obtain information about the masonry wall through review of available design, erection, fabrication and shop drawings, specifications, and manufacturers' instructions. A monitoring program should include a visual review of all areas of the building accessible for inspection through access openings, carried out regularly. Seasonal inspections help in observing the behaviour of different building materials in various weather conditions. What maintenance needs to be done and when depend on information obtained from monitoring. Timely implementation of maintenance work is the key to prolonging a building's life.

Table 9.2: Inspection Checklist for Brick Facing/Concrete Block Backing Cavity

	Masonry walls			
	North	South	East	West
Masonry				
Cracked unit				
Chipped unit				
Efflorescence				
Loose units				
Missing or clogged weep holes				
Deteriorated mortar joints				
Missing or incomplete head or bed joints				
Cracked mortar joints				
Failed bond between mortar and masonry unit				
Plant growth				
Out of plumb				
Spalled units				
Stains				
Water penetration				
Flashing and counter flashing				
Bent				
Missing				
Open lap joints				
Stains				
Caps and copings				
Cracked units				
Drips needed				
Loose joints				
Open joints				
Out of plumb				
Sealants				
Splits				
Separations (adhesion breakdown)				
Brittleness				
Cohesion breakdown				
Peeling				
Missing or incomplete sections				
Surface bubbling				

REPAIR

Despite the best efforts to maintain the masonry walls of a building, deterioration and damage may still occur. These situations usually require more intensive investigation than a general inspection. Whatever the defect, it is usually its effects that are identified first, before the defect is detected. Before making repairs on the obvious deterioration, the factors causing it must be understood and eliminated.

INVESTIGATION

Sometimes the defect is evident, but if not, then either non-destructive or destructive testing should be undertaken to identify it.

Examples of non-destructive tests are listed below:

- pachometer (metal detector)
- copper-copper sulphate half-cell (corrosion testing)
- acoustic impact (hammer tapping)
- electrical conductivity (water detection)
- infrared thermographic testing (heat loss or air leakage)
- monitoring
- photography
- air leakage testing

Examples of destructive and laboratory tests are the following:

- wind-pressure simulation
- strain gauge testing
- moisture and temperature cycling
- petrographic microscopy
- wet chemistry analysis
- x-ray diffractory testing
- infrared spectroscopy
- accelerated weathering
- freeze-thaw analysis
- visual observation

Before conducting any of these tests, the need for them should be considered in relation to the amount and value of the information sought. Non-destructive tests may provide some indication of a problem, but their results must usually be verified by destructive investigation. It is sometimes more cost-effective to proceed directly to a destructive verification. Once the source of the defect is discovered, measures can then be taken to effectively remedy both the source of the problem and its effects.

COMMON DEFECTS AND CONSEQUENCES

Masonry defects and their symptoms can be divided into two groups. These are structural, or movement related, and moisture related. In many cases, structural defects lead to moisture problems, as cracks develop in the building envelope that provide openings for moisture penetration. [Table 9.3](#), (p. 9-6) can be used to trouble-shoot common failures and defects.

MOISTURE AND FREEZE-THAW

Nearly all moisture-related defects result in freeze-thaw damages to masonry. This is of less concern in places such as Victoria, British Columbia. On the whole, however, Canadian winter temperatures fluctuate over and under the freezing point many times annually, creating the familiar freeze-thaw cycle. Masonry and related elements can cope admirably with this, on one condition: that the masonry unit is not saturated. The presence of significant moisture in the masonry components will delaminate and spall mortar and masonry within a few winters. The best practice details are designed to minimize the accumulated moisture in the wall cavity and the masonry components.

EXPOSURE

Excessive weathering is problematic for all materials and systems. Any conditions that result in repeated and constant wetting of wall elements will cause premature deterioration. Typical factors creating these conditions are the following:

- lack of eavestroughing, insufficient overhangs and insufficient capacity of eavestroughing
- roof configuration that results in runoff concentrations (valleys and offsets)
- proximity to grade or balcony and deck surfaces, creating conditions of long-term exposure to moisture
- sills, ledges and other architectural features such as precast ledges and quoins
- sloped roof or glazing that drains water onto masonry walls
- splashing and rising damp

A look at traditional, pre-1950s housing and building design reveals a higher level of care and understanding in incorporating measures to avoid these conditions; construction since the 1950s has often disregarded these lessons learned.

FLASHINGS AND COPINGS

Traditionally, when design features subjected masonry systems to wetting, a system of flashings and copings was introduced. Parapet walls, window sills, wing walls and such would always be protected in some way from incident water and runoff. The appropriate use of these measures prevented much of the deterioration that occurs in many newer buildings.

A very interesting example of the failure to understand this most basic concept of protection is the omission of flashing under masonry sills and coping, as required by building codes. Inspections of many buildings indicate that this flashing is seldom installed.

VAPOUR BARRIERS

Correct application of vapour barriers prevents condensation build-up within the wall system. Symptoms of this form of failure include efflorescence, spalling and water stains.

AIR BARRIERS

Correct application of air barriers prevents not only condensation build-up but also heat loss through loss of air. Some symptoms of a failing air barrier are the same as those for vapour barriers, but they can be more dramatic.

MOVEMENT JOINTS

Large masonry panels must be given room to expand and contract, with an allowance for the movement of adjacent building components, particularly the structure. Failure to account for this will result in compressive and tensile stresses within the masonry or adjacent materials. Typically, lack of sealed soft joints in masonry panels between floor structures will result in cracked masonry. Lack of vertical movement joints in walls will create undesirable cracking around windows and doorways, the weak points in the wall skin. Chapter 3, “Building Science Concepts,” deals with the proper design of masonry to control cracking.

SHELF ANGLES

Multistorey buildings with masonry cavity walls generally require a regular horizontal support system, as described in Chapter 3. This generally consists of a concrete slab and shelf angle fastened to the structure. Because this interrupts the continuity of the masonry and drainage cavity, this joint must be treated carefully to maintain structural integrity and water control. Poor joint design or construction can result in all possible masonry failure symptoms known.

Table 9.3: Summary of Masonry Defects and Causes

Possible causes	Symptoms				
	Efflorescence	Water leaks	Wall deformations	Cracking	Spalling
Generic Cause	Excess moisture, presence of salts in mortar or masonry	Water entry into wall system through masonry or related construction	Structural or material failure originating from design or construction defects	Shrinkage or structural and material failure	Excess moisture, coupled with freezing and thawing
Missing or defective flashing	•	•			•
Sealant defect	•	•			•
Through-wall air or vapour transmission	•	•			•
Lack of adequate movement joints			•	•	•
Poor structural support			•	•	•
Lack of lateral restraint			•	•	
Inadequate soft joints at structure			•	•	•
Excess salts (calcium chloride) in mortar	•				
Masonry unit or mortar defects	•	•	•	•	•
Cracking or displacement	•	•	•	•	•

Addleson, Lyall. *Building Failures: A Guide to Diagnosis, Remedy and Prevention*. London: The Architectural Press, 1982.

Alberta Building Envelope Council. *Building Envelope Failures: Causes and Remedial Measures*.

Allen, D. E. "Damage to Brick and Stone Veneer on Tall Buildings," *Building Practice Note No. 7*. Ottawa: NRC 1978.

American Society for Testing and Materials. *Masonry: Materials, Properties and Performance* (Proceedings of Masonry Symposium) Philadelphia: ASTM, 1980.

———. *Masonry: Research, Application and Problems* (Proceedings of Masonry Symposium). Philadelphia: ASTM, 1983.

Andres, C. K., Honkala, T. L., and Smith, R. C. *Masonry: Materials Design Construction*. Reston, VA: Reston Publishing Company Inc., 1979.

Bannister, Jay. *Building Construction Inspection – A Guide for Architects*. New York: John Wiley & Sons Inc., 1991.

Beall, Christine. *Masonry Design and Detailing for Architects, Engineers and Builders*. New York: McGraw-Hill, 1987.

Brand, Ronald. *Architectural Details for Insulated Buildings*. New York: Van Nostrand Reinhold, 1990.

Brick Institute of America. "Moisture Control in Brick and Tile Walls," *Technical Notes on Brick Construction* (No. 7C reissued). Reston, VA: BIA, November 1981.

———. "Water Resistance of Brick Masonry Design and Detailing," *Technical Notes on Brick Construction* (No. 7 revised). Reston, VA: BIA, 1985.

———. "Brick Masonry Cavity Walls" *Technical Notes on Brick Construction* (No. 21 series revised and reissued). Reston, VA: BIA, 1986, 1987, and 1989.

———. "Moisture Resistance of Brick Masonry Maintenance" *Technical Notes on Brick Construction* (No. 7F reissued). Reston, VA: BIA, January 1987.

———. "Moisture Resistance of Brick Masonry Walls: Condensation Analysis," *Technical Notes on Brick Construction* (No. 7D revised). Reston, VA: BIA, May 1988.

———. "Mortars for Brick Masonry," *Technical Notes on Brick Construction* (No. 8 series revised). Reston, VA: BIA, 1988 and 1989.

———. "Movement Design and Detailing of Movement Joints Part II," *Technical Notes on Brick Construction* (No. 18A revised). Reston, VA: BIA, December 1991.

Canada Mortgage and Housing Corporation. *Commissioning and Monitoring the Building Envelope for Air Leakage* (Report No. 33127.02). Ottawa: CMHC, November 29, 1993.

Canadian Standards Association. *CSA Standards on Concrete Masonry Units* (A165-M Series). Toronto: CSA, March 1977.

———. *Burned Clay Brick (Solid Masonry Units Made from Clay or Shale)* (CAN/CSA-A82.1-M87(R92)). Toronto: CSA, 1992.

- . *Mortar and Grout for Unit Masonry* (CSA A179-94). Toronto: CSA, February 1994.
- . *Masonry Construction for Buildings* (CSA A371-94). Toronto: CSA, February 1994.
- . *Connectors for Masonry* (CSA A370-94). Toronto: CSA, February 1994.
- Construction Specifications Canada. TEK Aid Reference 07195 – Air Barriers. Toronto: CSC, March 1990.
- Dale, D. Kerr. “The Rain Screen Wall,” *Progressive Architecture* 890.
- Davison, J. I. “Masonry Mortar,” *Canadian Building Digest No. 163*. Ottawa: NRC, 1974.
- . “Rain Penetration and Masonry Wall Systems,” *Building Practice Note No. 12*. Ottawa: NRC, 1979.
- Drysdale, Robert G. *Construction Problems in Multi-Family Residential Buildings*. Ottawa: CMHC, and Ontario New Home Warranty Program, March 1991.
- Drysdale, Robert G., and Suter, G. T. *Exterior Wall Construction in High-Rise Buildings, Brick Veneer on Concrete Masonry or Steel Stud Wall Systems*. Ottawa: CMHC, 1991.
- Garden, G. K. “Rain Penetration and Its Control,” *Canadian Building Digest No. 40*. Ottawa: NRC, April 1963.
- Hutcheon, N. B. “Requirements for Exterior Walls,” *Canadian Building Digest No. 48*. Ottawa: NRC, December 1963.
- . “Principles Applied to an Insulated Masonry Wall,” *Canadian Building Digest No. 50*. Ottawa: NRC, February 1964.
- Hutcheon, N. B., and Handegord, G. O. P. *Building Science for a Cold Climate*. Toronto: John Wiley & Sons, 1987.
- Masonry Institute of British Columbia. *A Guide to Rain-Resistant Masonry Construction for the B.C. Coastal Climate*. MIBC, 1985.
- National Research Council of Canada. “Exterior Walls: Understanding the Problems,” *Proceedings of the Building Science Forum '82*, Ottawa: NRC, April 1983.
- . *National Building Code of Canada*, Ottawa: NRC and Assoc. Comm. on the National Building Code, 1993.
- Ontario. Ontario New Home Warranty Program. *Condominium Construction Guide 1991* (Revised 1st ed.). Don Mills: Ontario Ministry of Housing and Ontario Hydro, 1993.
- . *Ontario Code and Construction Guide for Housing* (2nd ed.). Don Mills: Ontario Ministry of Housing and Ontario New Home Warranty Program, June 1993.
- Panarese, W. C., Kosmatka, S. H., and Randall, F. A. *Concrete Masonry Handbook for Architects, Engineers, Builders* (5th ed.). Skokie, IL: Portland Cement Association, 1991.
- Plewes, W. G. “Failure of Brick Facing on High-Rise Buildings,” *Canadian Building Digest No. 185*. NRC, 1977.

- Poirier, G. F., and Brown, W. C. "Pressure Equalization and the Control of Rainwater Penetration Under Dynamic Wind Loading" (NRC Construction Technology Series). *Construction Canada Magazine*, March-April 1994.
- Quirouette, R. L. "The Difference Between a Vapour Barrier and an Air Barrier" *Building Practice Note No. 54*. Ottawa: NRC, 1985.
- Ritchie, T. "Rain Penetration of Walls of Unit Masonry," *Canadian Building Digest No. 6*. Ottawa: NRC, June 1960.
- . "Cavity Walls," *Canadian Building Digest No. 21*. Ottawa: NRC, September 1961.
- . "Bricks," *Canadian Building Digest No. 169*. Ottawa: NRC, 1974.
- University of Saskatchewan. *Sixth Canadian Masonry Symposium* (Vols. I and II). Saskatoon: University of Saskatchewan, 1992.
- Wilson, A. G., and Tamura, G. T. "Stack Effects in Buildings," *Canadian Building Digest No. 104*. Ottawa: NRC, 1968.
- Wilson, Michael. *Structural Behaviour and Rain Screen Performance of Brick Veneer Wall Systems*.

FILES ON CD-ROM

Drawing Files

The details included in this guide are also included in the CD-ROM as AutoCAD® release 12 DWG files, and as DXF files. All are provided in SI (Metric) versions at 1:5 scale and are plotted at 1:1 plotting scale, with layers offering a choice of English or French notes and titles. Refer to README.TXT on **CD-Rom** for further information.

This CD contains the following directories and their sub-directories:

- DWG (A directory containing drawings of details in AutoCAD)
- DXF (A directory containing drawings of details in DXF format)
- PDF (Complete set of the documentation in PDF format)
- SPEC (Complete specification in txt file format)

About 4.1 megabytes of free space is required for the DWG files and 13.3 megabytes for the DXF files.

In addition to the above directories, the CD contains the following files:

AR16E301.EXE : Installs Acrobat Reader for Windows 3.1x
AR32E301.EXE : Installs Acrobat Reader for Windows 95
LIC_RDR.PDF : A licence agreement for the Acrobat Reader
README.TXT : The README file
LISEZMOI.TXT : Same as the README file but in French

To install the Acrobat Reader on Windows 3.1x:

1. From Program Manager, Select **File** then **Run**
2. Browse and Select AR16E301.EXE
3. Click on OK

Follow the instructions on the screen.

To install the Acrobat Reader on Windows 95:

1. From **START** menu, Select **Run**
2. Browse and Select AR32E301.EXE
3. Click on OK

Follow the instructions in the screen.

Specification Files

The guide specification, section 05410, is included in the CD-ROM in WP5 format conforming to the CSC Electronic Style Guide, and in several other formats, one of which should be capable of being used with almost any PC-compatible word processor. It is provided in both English and French, in SI (Metric) units, CSC Page Format, and refers to applicable Canadian standards. Refer to README.TXT on **CD-Rom** for further information.

* © Autodesk.