



UP!

A new Global Energy Forum for a new Dubai

Awarded Second Prize in ArchMedium International Competition 'DGEF'

April 2014

Team: Haylie Chan, Justin Lai & Jack Lipson

ARCH 346 : Competition Elective

Professor: Terri Meyer Boake

Jack Lipson 20384850

PART I. BRIEF

“Dubai is the sixth richest country in the world thanks to the boom that followed the discovery of oil deposits in its territory during the midsixties. Since then it has grown at a frenetic pace going from a small settlement to a large city of skyscrapers, luxury and over-the-top works of engineering and architecture, all in less than half a century.

Without a doubt, oil has been the driving force of this growth to the point where many refer to the wealth of the UAE as “petrodollars”. However, Dubai is the emirate with the least amount of oil reserves in the Persian Gulf area, therefore its prosperity was born with an expiration date, something that the royal family and the government have been well aware of since the first moment, which is why after a decade dedicated to creating a robust oil exportation system, in the 1980’s they started to show a grand political effort to diversify their economy.

If changing the economy of a country is an elaborate task, more so is to change the perception that other countries have of Dubai. One bit at a time, the large multinational corporations that are unrelated to the oil sector, are realizing the benefits of establishing their businesses in the emirate, however most of society still relates Dubai to oil and all the negative connotations that come with the sector in a world that’s more aware every day of the importance of abandoning this type of energy sources in favor of others that are cleaner, sustainable and respectful of our planet.

Dubai and the countries of the Persian Gulf are making countless efforts to show the world its best image, efforts which have won it the candidacies for the World Expo 2020, and the soccer world cup of 2022.

With the same objective and the same Sheikh Mohammed bin Rashid Al Maktoum (sheikh of Dubai and vice-president of the UAE) as the main promoter of the event, in April of 2013 Dubai organized the first Global Energy Forum, with the objective of attracting the top representatives of the world’s energy enterprises, as well as scientists and professors to generate a debate platform

from which new proposals for the global energetic future could emerge. This will help the Dubai Supreme Council of Energy to fulfill its goal of becoming a 100% ecological city by 2030 and serving as an example and a tool for other countries who may decide to join the proposal and take the same course as the small emirate.

The event was a success with hundreds of companies from a variety of sectors showing a great disposition to debate and listen to proposals, new studies and scientific advances that may contribute in the next decades to mitigate the environmental impact that our presence on the planet has today.

CHALLENGE

For this exercise we are going to consider that after the success of the first Global Energy Forum, Dubai has decided to turn this into an annual event and wants to give it a fixed venue to accommodate it in its upcoming editions.

The periodicity of this event will help to strengthen the image of long-term commitment that Dubai has made with the environment, beyond a timely act that may be considered as a media strategy with no real dedication behind it. Dubai has already begun its transformation process but it knows how important it is for its global image not just to become a sustainable city but for the rest of the world to become aware of it too.

For this reason, the new venue for the Global Energy Forum should not only be a practical building that facilitates the development of the event activities, but also represent the change that the Supreme Council of Energy is seeking and should help to spread its message and vision throughout the world. The building must become an icon of global energetic change and a social promise which, far from an abstract ideal, has already begun.”

-provided by ARCHMEDIUM

PART II. PROJECT

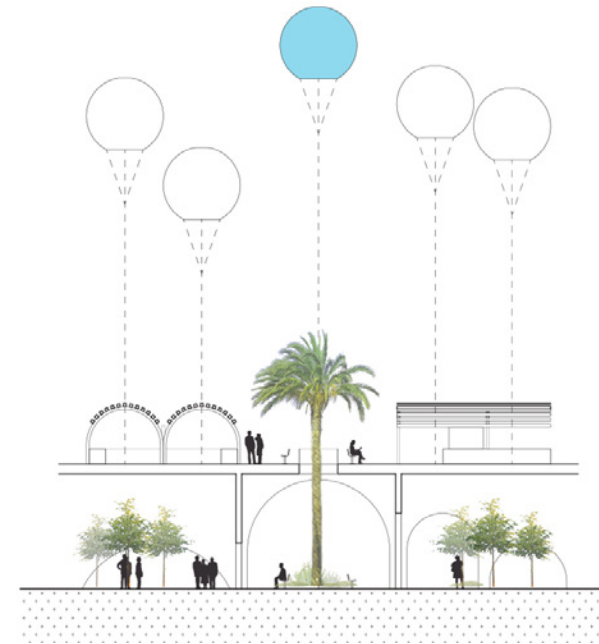

01. Environmental Iconicism.

UP! is a future model for a new sustainable building typology that reinterprets the notion of architectural iconicism. Spanning throughout history, up until the modern era which is overwhelmed by the allure of skyscrapers, there has always been a distinct fascination of sculpturalism and the height of a building. However, building occupiable space at such alarming heights desensitizes the intimacy of architecture at a human scale and simply serves as counter intuitive to an architecture that strives for sustainability.

the most playful and accessible way possible. As a sunken structure that is comprised of fundamentally passive systems and architectures, UP! modestly hides itself under a blanket of highly engaging public program - resulting in a 'non-icon' submerged under the urban fabric. Public program such as gallery, park, market, child leisure and recreation [both above and below ground] gives life to the site for an entire 365 day cycle - a place for family and communal vibrancy.

The concept of UP! is to propose a new typology that infuses the aspects of the "icon" with "sustainability" in

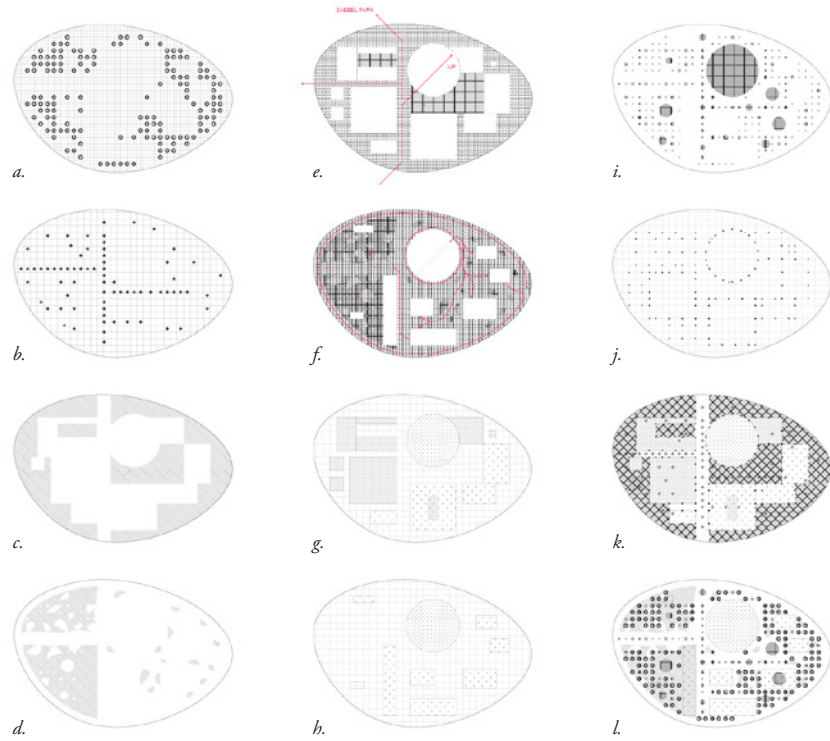

The axonometric [right] and planometric set [above] highlight the degrees of layering that exist within the project - both programmatically and geometrically. An overlapping of structural, void and circulation elements creates multiple complexities and nuances in the scheme - a scheme reliant on the interaction and cooperation of these elements. With voids serving numerous purposes [as entrances, public spaces, openings for the eco-balloons, etc.] a hierarchy is generated; an order that governs the scheme. Living among these architectonics is a complex and dynamic program ranging from the Global Energy Forum itself to the range of spaces

in the park [gallery, amphitheatre, bicycle loop, picnic areas etc.]. *With the intention to create a public node in the city, the multiplicity of program serves as the backbone to the scheme.* The pergola roofs and open park spaces provide a layer to the Dubai urban fabric, one that demands for more public space, notably around the city core. A space that can generate both global and local attention - the Up! project serves a role larger than its initial intentions. By including program outside the Forum, it acts as a centre to a community - a community that can use the project's public space all year long.

Plan Matrix

- A. balloons
- B. trees
- C. green space [below]
- D. green space [above]
- E. circulation [above]
- F. circulation [below]
- G. program [below]
- H. program [above]
- I. openings
- J. structure
- K. zoning
- L. secondary openings



ECO-balloons

pergola roof

Ground Level [0]

- 01. playground
- 02. kid's park
- 03. social park
- 04. amphitheatre
- 05. toilets
- 06. tour centre
- 07. picnic area
- 08. cafe
- 09. market place
- 10. bike shop
- 11. gallery
- 12. museum of sustainability
- 13. cycling loop

Sub-Terrain Level [-1]

- 01. secondary room
- 02. translation room
- 03. toilets
- 04. amphitheatre
- 05. conference room
- 06. office & administration
- 07. toilets
- 08. translation rooms
- 09. cafeteria
- 10. restaurant & kitchen
- 11. gallery
- 12. parking & storage

Dubai communal gardens



High Condition:
Eco-Balloons soar above the site collecting wind and solar energy.

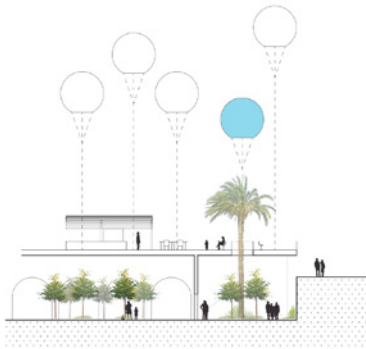

Low Condition:
Eco-Balloons are pulled closer to the park creating a more intimate architectural environment.

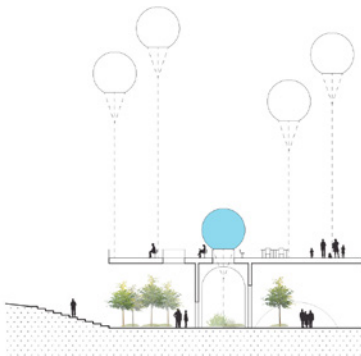

Lantern Condition:
Using embedded LEDs, the Eco-Balloons are pulled towards the park and create beacons of light and localized interactive moments.

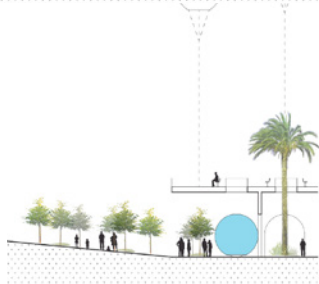

Energy Collection:
The internal batteries are collected below the park and harnessed into energy for the site.

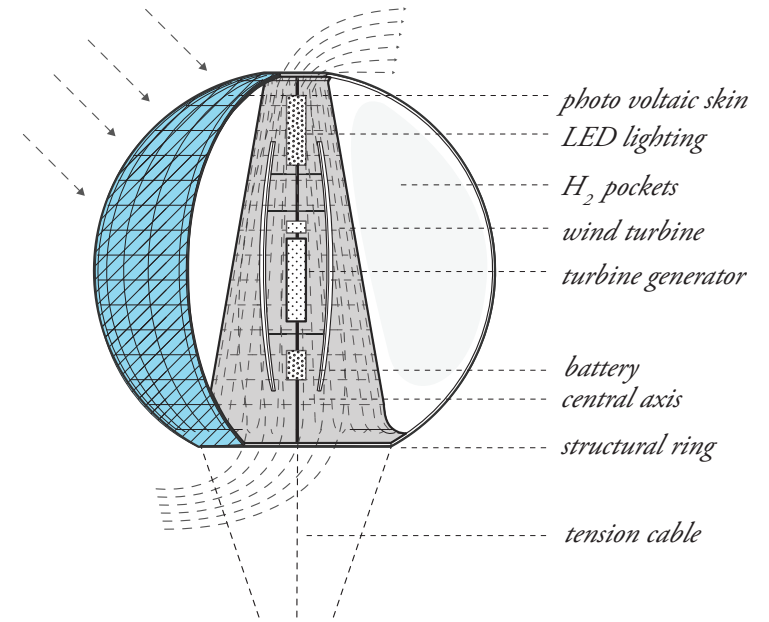

A system of “Eco-Balloons” exist on the site and function on multiple strata, each with own purpose and affect on the park. As elements that both harness sun and wind - the “Eco-Balloons” soar above the site collecting the proper energy to power the project while giving a vibrance and playfulness to the core of the city. The sky is the limit in terms of height, as these icons in themselves can ascend to heights comparable to the tallest structures in the world. This results in a true icon of sustainability and growth - a public space that can be recognized for its presence, at many scales, and its craft. Over the last turn of the century, sustainability has been a vital part of the discussion regarding future designs. UP! is a concept that embodies the “icon” in the most playful, intimate and human way possible – an architecture that can provoke a friendly future to the new direction of Dubai.

PART III. PRECEDENTS + REFLECTION

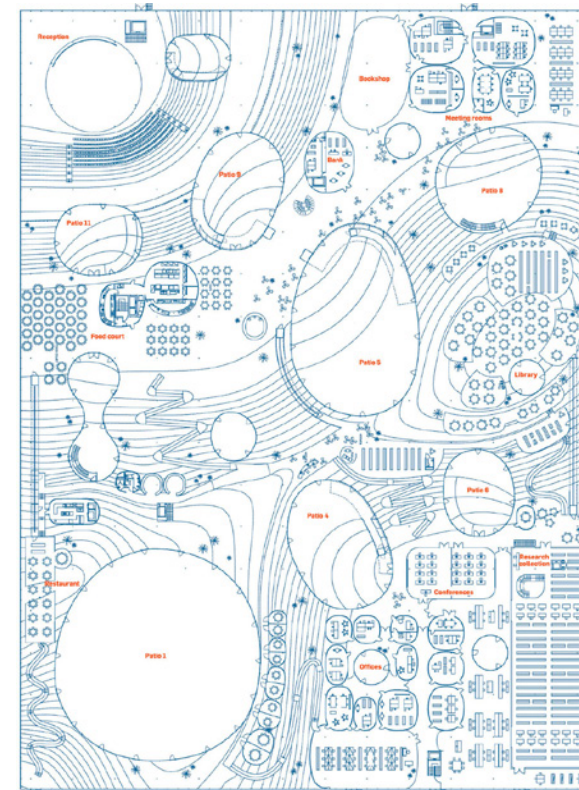

fig 01. Rolex Centre. SANAA 2010

The ambition and vision that our team shared for the DGEF competition in our Up! proposal required looking at the project from a variety of scales - from the scale of our desired mechanics, to that of a building, to what essentially became the scale of a pop-up city. It was our intention to not only create a great, usable public space that would fulfill the current demand of the community, but to rethink how the city could operate as it moves forward into a more ecologically aware future. With society looking to a more sustainable future, it made little sense in forming a scheme that was anything but forward thinking - to create with the technology of the present was to miss the point, and ultimately design for the past. This desire allowed us to rethink and really define how we saw terms like "sustainability", "public space" and "monumentality" and try to

find a harmony between technological advancement and vernacular resistance. As a project that demanded a fair amount of research, we found ourselves in the interesting situation of switching back and forth between researching local tradition, in terms of passive architecture, and projects that looked to invent new systems and technologies for energy and sustainable production.

This project is the product of many inspirations and precedents - past ideas and projects that helped us to understand our concept in terms of its form and function as a pop-up city within the city. In this reflection I will break down our major influences in the terms of form, function and new city typologies with the intention of pulling the project apart to reveal the process that lead to its execution.

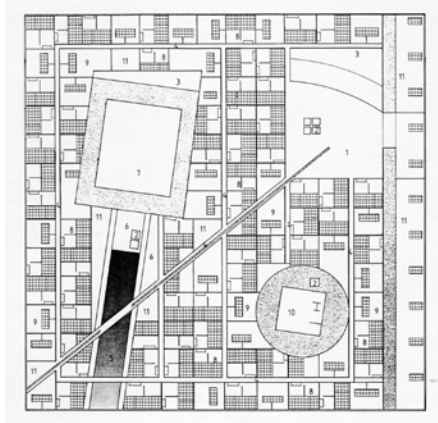
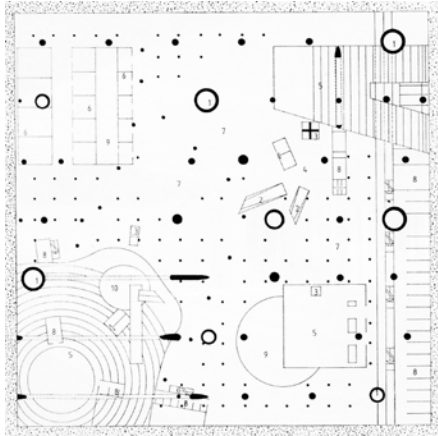

fig 02. Agadir Convention centre, OMA 1990

FORM The basic form of Up! is a composite of the vernacular, middle-eastern arched building - one that relies on heavy thermal mass and subterranean placement for environmental livability and a large, publicly accessible roof. In essence the Forum itself becomes associated with the traditional, protected architecture while the openness of the roof situated park becomes an urban space - open to everyone all year round. Form followed concept in the scheme with many different overall shapes considered, all of which containing the layering of architecture and program described previously [page 6].

As the scheme developed two projects were saved as constant reference as excellent contemporary examples of the hybridization of open program and structured form that we hoped to achieve in our project. The first project was OMA's Agadir Convention centre. This proposal successfully brings together a multiplicity of program into a singular form and relies on the interaction between different elements to drive the project. Although our project's exterior form hardly resembles the Convention centre, the ideologies it expresses are one in the same and it is from the schemes relentless overlapping of programmatic conditions that we took inspiration.

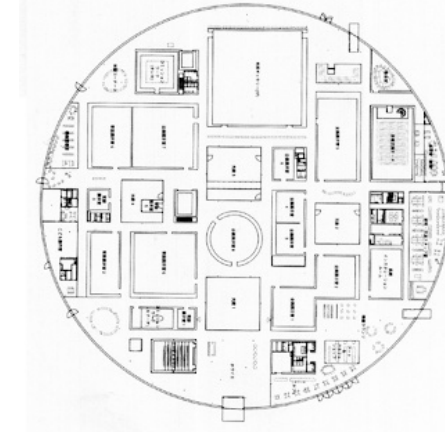
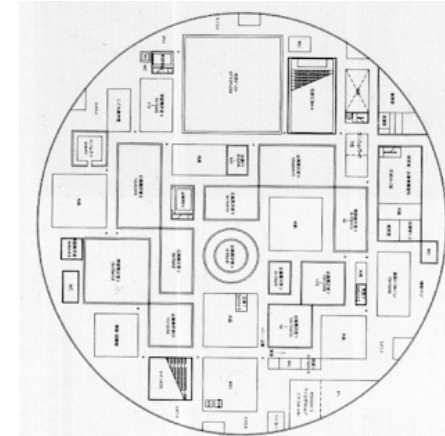

fig 03. 21st Century Museum of Art, SANAA 2004

In addition to OMA, Japanese firm SANAA and their projects, as well as their methods of representation, played into our process and helped guide our project. SANAA masterfully deals with projects with loosely organized programmatic conditions, that engage with concepts of flexibility, impermanence and the exchange between unique activities. They have produced many projects, such as the Toledo museum, the 21st Century Museum of Art and the Vitra campus which play with the ideas of creating beautiful spaces and interstitial spaces as a by product of overlapping, or alternatively, seeming excess forms and volumes. They engage with the idea of overlapping pure

geometries with both regular and fluctuating grids to produce unique conditions and moments which ultimately contribute to the buildings in their collection. Formally we looked at these projects as a collection of recognizable forms organized in unique ways to create unique spaces. The circular voids and overall round shape of the project, for instance, is extracted from the underlying concepts behind SANAA's projects - most recognizably in the Rolex Centre in Lausanne, Switzerland.



fig 04. The Umbrellas. Jeanne Claude and Christo 1991

FUNCTION The basic function of the project, as requested in the assignment brief, was to provide central Dubai a global energy forum that would serve as both a functional space for annual meeting as well as an icon that would effectively project the future ideologies of the society's sustainable growth. As described in the project summary, we spent much time questioning the notion of the "icon" or the "monument", with explicit regard to sustainability and realized an inherent contradiction in the commonly perceived architectural monument and the ideologies embedded within the sustainable movement. The 21st monument is one of grandeur and excess with, often, little attention to environmental implication. A race to the sky by means of glass and steel boxes is a driver for many designers seeking contemporary architectural supremacy - and this basic flaw is something we hoped to question

in our process. We hoped to create an architecture that wouldn't be seen as a monument with sustainable features - a soaring tower with a slapped on curtain wall facade system - but rather an architecture that was seen as a monument solely because of its sustainable integration. Using our "eco-balloons" we achieve the height of any tower, yet we attain that height through elements that are linked directly to the energy strategy of the site - elements that operate on both the monumental and mechanic scales.

Early on we looked at a variety of projects that seemed to share the same opinion on the concept of the "monument". One example that stands out are the works of Jeanne Claude and Christo. Their projects share a uniquely wonderful harmony of playfulness and simplicity while often redefining what it means for art to become monu-



fig 05. Weather Field. LCLA and Lateral Office 2010

mental. Despite the use of light weight fabrics and small base components, Jeanne Claude and Christo use the power of repetition and a collective image to almost artificially simulate monumentality, establishing an image that is a sum of its parts. Their work helped inspire the notion that a countless series of hypothetical balloons soaring over the desert horizon could, in fact, be more monumental to a solid, uniform tower of the same scale. A monument of sustainability could be an icon that changes, adapts and moves through the wind that it is meant to utilize and expose.

Once the concept of the balloons was established we researched if there were any precedents, either implemented and theoretical, involving combining wind and solar collection through airborne systems. We discovered the

project 'Weather Field' by Lateral Office and LCLA which proposed unifying energy and recreation infrastructure. Through a series of energy-aware para-sails and kites the project aimed to provide a new approach to the energy grid and suggest a new typology for energy structures in open, arid, desert conditions. Like the Up! scheme, Weather Field was based in a middle-eastern site, influenced by the same challenges and political obstacles of the region - these commonalities allowed us to learn from this project and helped us form our opinions on our own scheme and its design opportunities.

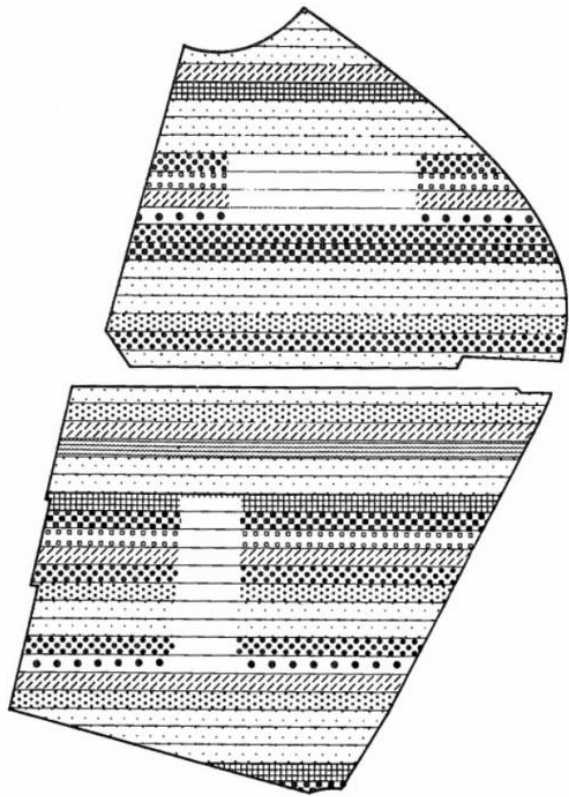

fig. 06. Parc La Villette. OMA 1982

POP-UP CITY It was important for us to create a park that was both monumental and tangible, one that spoke to the large scale of the project's ambition as well as the human scale of the day-to-day visitor. Like a city, the park would be a dense layering of program where the countless interactions and unique experiences found within the structure of a city were encouraged. This desire brought us to Rem Koolhaas's scheme for Parc La Villette where by the stratification of program and sequential human interaction drove the project. Like Koolhaas's scheme, our project saw the park as system - a collection of common elements organized in a way to create unique conditions.

In conclusion the Up! project gave us an excellent opportunity to dive into some research and use what we found in order to develop our developing ideologies and opinions

on the subject matter. We chose to enter this competition with the intention to look at sustainability and ecological aware design through a different lens than what we have used before. As a vehicle for new discovery and experimentation, the Up! project was very successful, with many of the perceptions gained through the process maintained in my current design work.

IMAGES:

- fig. 01 <http://www.bdonline.co.uk/journals/Graphic/1/w/d/planat00mlevel.jpg>
 fig. 02 <https://mcharco.files.wordpress.com/2013/09/cj-01b21.jpg>
 fig. 03 <https://s-media-cache-ak0.pinimg.com/736x/79/4a/4a/794a4a2ef59063bb6ce4aa7ba2d1cffb.jpg>
 fig. 04 <http://all-that-is-interesting.com/incredible-christo-and-jeanne-claude-works>
 fig. 05 <http://lateraloffice.com/WEATHERFIELD-2010>
 fig. 06 <https://s-media-cache-ak0.pinimg.com/originals/7a/61/22/7a612287f4317160a78dc4fe7c438f18.jpg>

