

# FIRE PROTECTIVE DESIGN



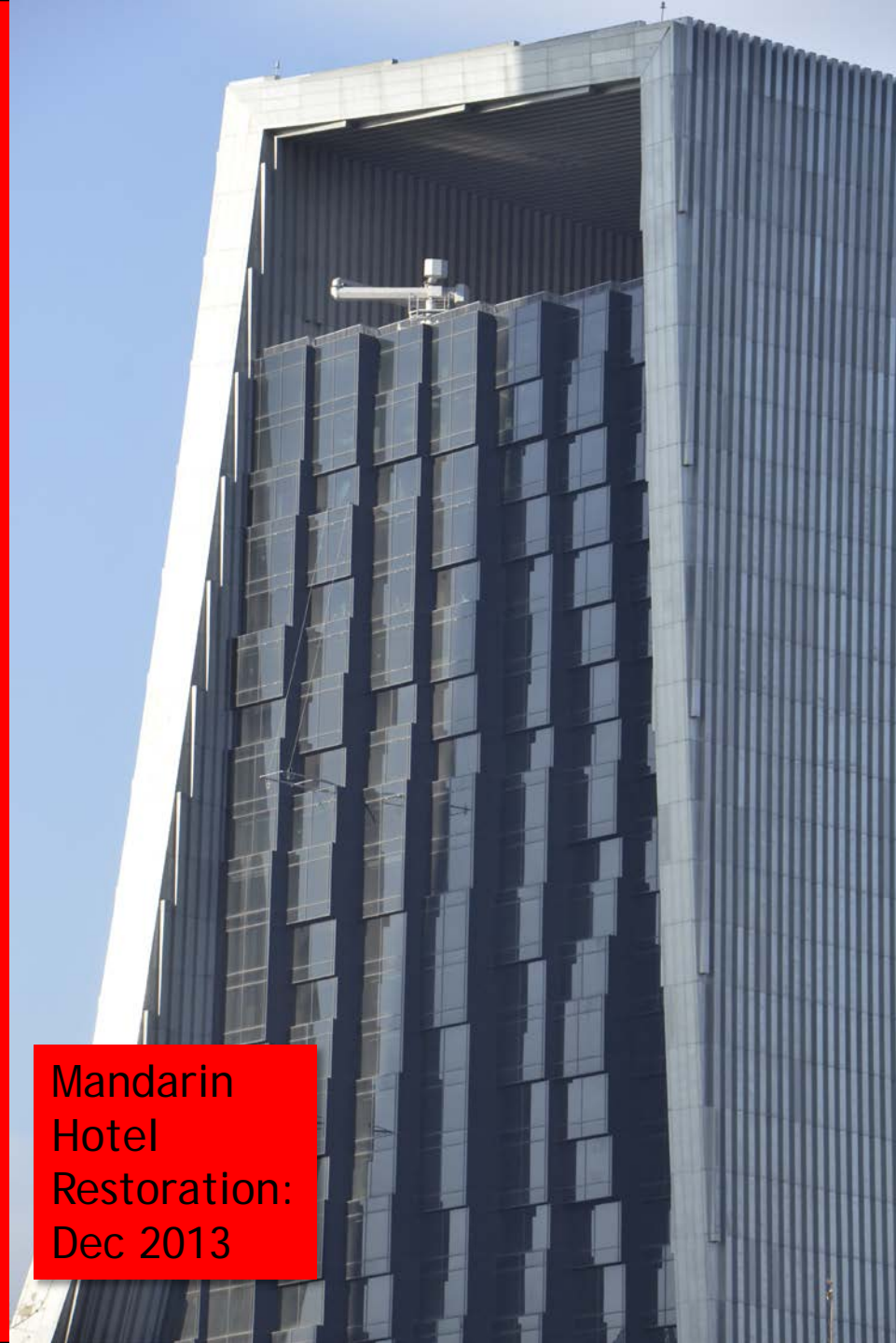
Mandarin  
Hotel Fire:  
Feb 2008



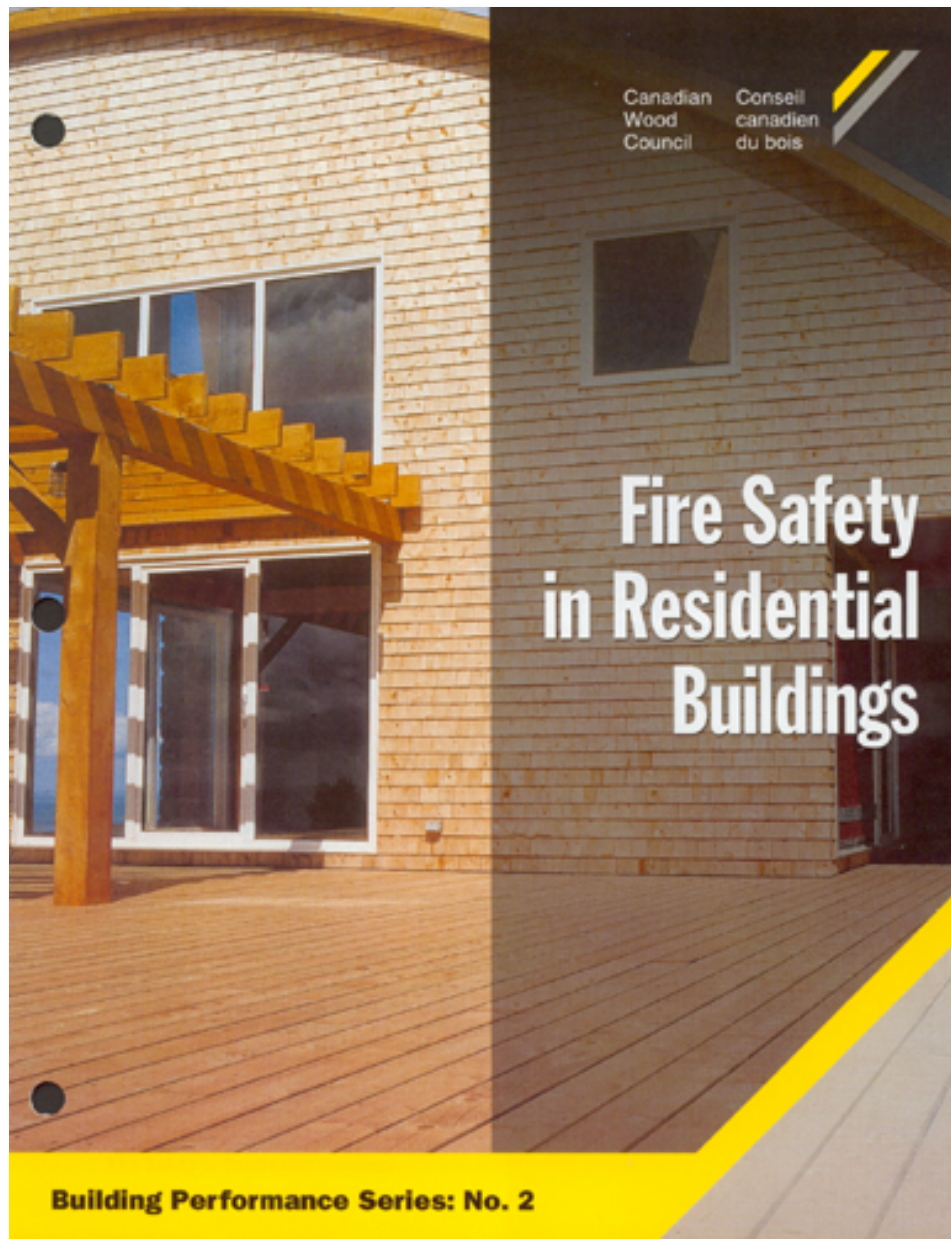


Mandarin  
Hotel  
Restoration:  
Oct 2011





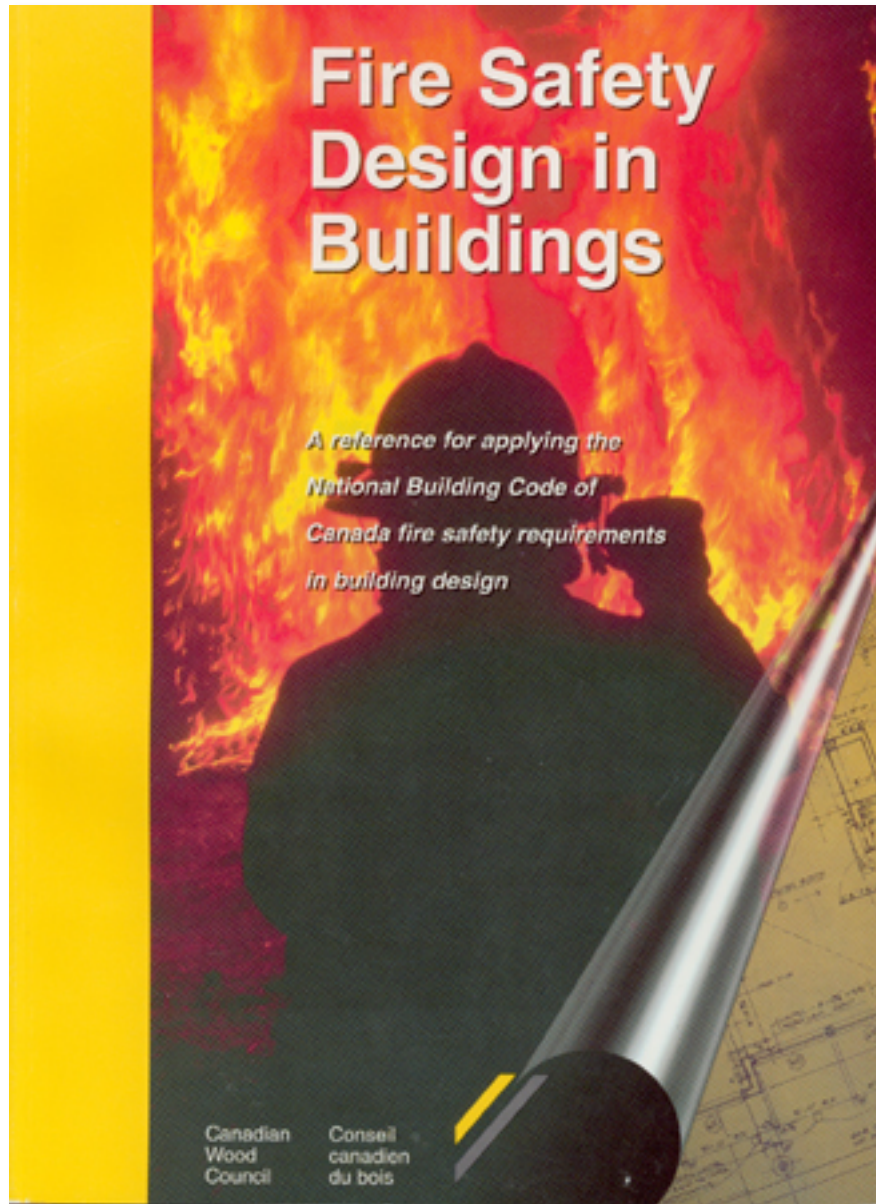
Mandarin  
Hotel  
Restoration:  
Dec 2013



Fire code issues are dealt with in the National Building Code. It has a separate document concerning fire.

It is also addressed in other guides, like those published by the Canadian Wood Council.



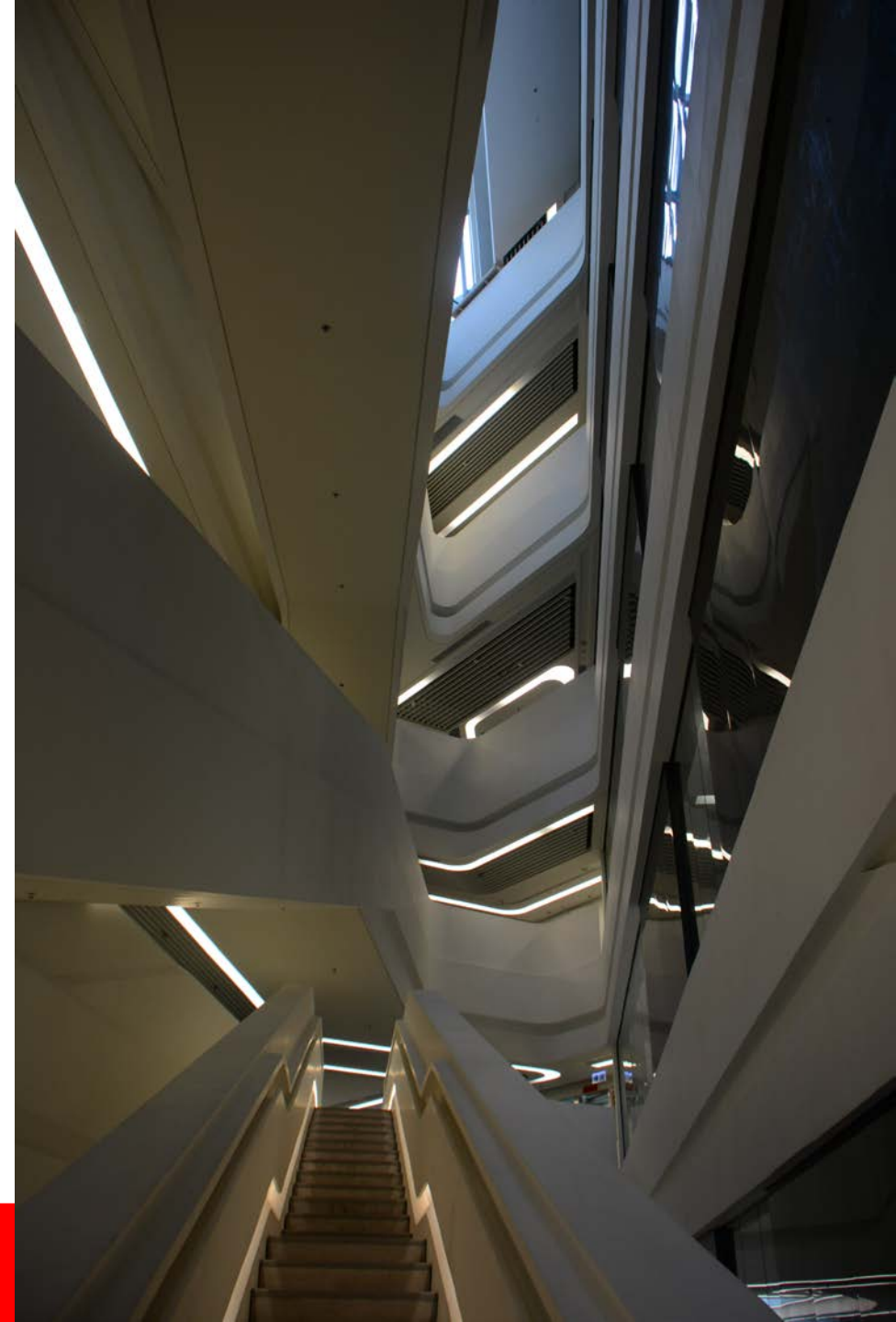


This is a comprehensive reference published by Canadian Wood Council addressing fire safe design in buildings.

Fire regulations vary around the world, but the ones we use in Canada are some of the most stringent.



- There are basic code requirements to which we are obliged to design to
- These are fine for very straightforward, simple designs (most standard houses, apartments)
- As designs become more complex, with unique spatial combinations, atriums, connected floor spaces, we employ a Fire Engineer to assist with the design strategies
- These may include the evacuation/control of smoke and fumes to permit safe evacuation.





## Primary Motivation in Design:

### No. 1: Life Safety

no loss of life

safe evacuation of occupants

### No. 2: Protection of Structure

maintaining integrity of building  
structure

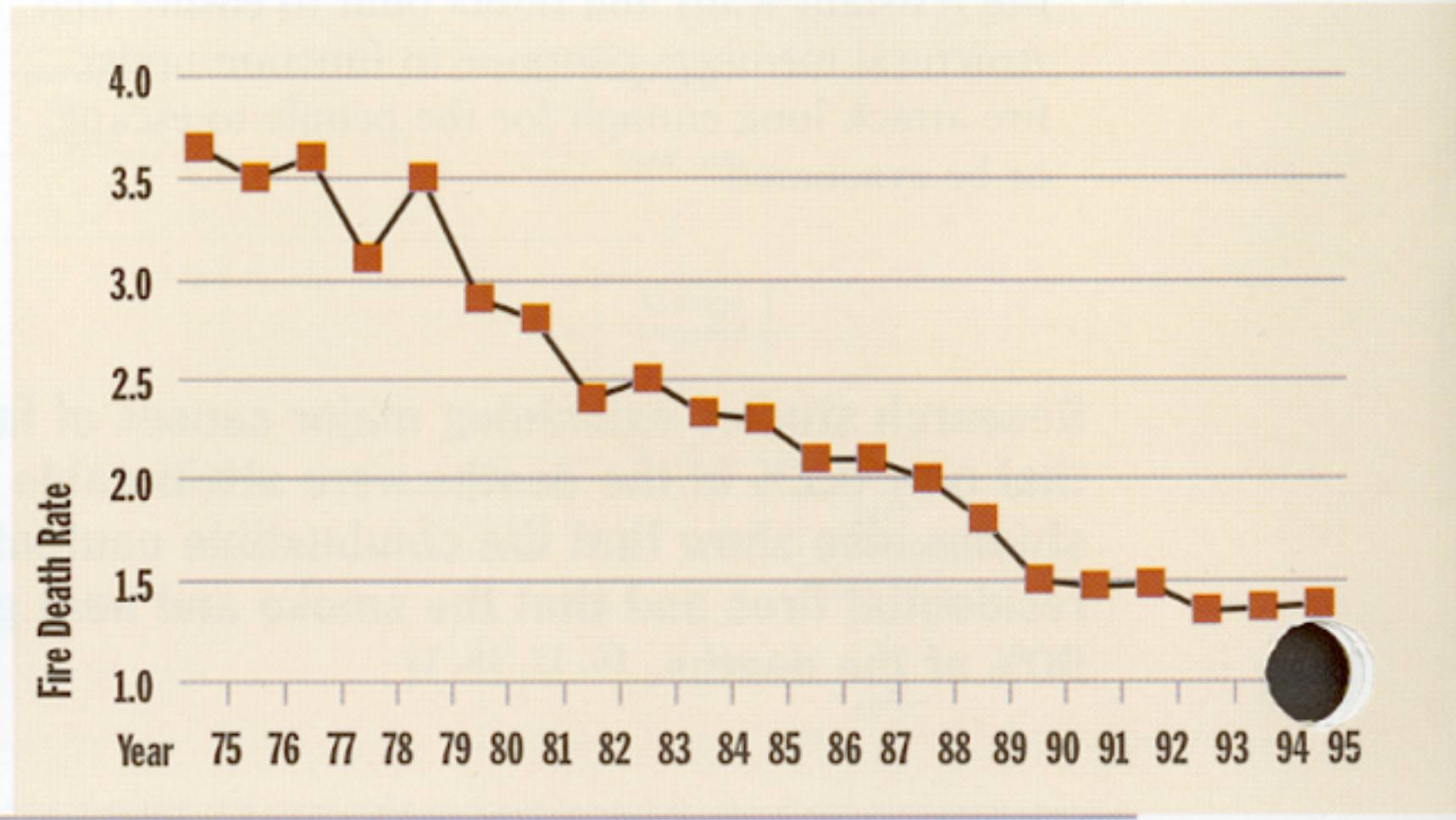


# Non Negotiable

- Fire safety is pretty well a fixed, non negotiable Building Code issue
- Building Code is a set of MINIMUM standards designed to PROTECT the public
- You cannot design for SAFETY below MINIMUM
- i.e. Just a few dead people rather than dozens is not acceptable so that you can “make your design” more interesting



**Figure 3** Annual Fire Death Rate per 100,000 Residents



**Table 1** Fire Losses in Canadian Residential Buildings for 1993-1995 <sup>21</sup>

<b>Occupancy</b>	<b>Fires</b>	<b>Deaths</b>	<b>Deaths per 100 Fires</b>	<b>Injuries</b>	<b>*Injuries per 100 Fires</b>
1 & 2 Family	51,423	609	1.18	3,999	7.78
Apartment	17,677	181	1.02	2,396	13.65
Boarding	812	23	2.83	193	23.77
Hotel	803	7	0.87	101	12.58
Motel	293	4	1.37	24	8.19
Dormitory	195	0	0.00	6	3.08
Mobile Home	2,326	53	2.28	112	4.82
Miscellaneous	3,784	34	0.90	164	4.33
<b>Total</b>	<b>77,313</b>	<b>911</b>	<b>1.18</b>	<b>6,995</b>	<b>9.05</b>

*\*Includes firefighters*



**Table 5** Residential Deaths and Injuries by Construction Type – All Fires <sup>22</sup>

<b>Construction Type</b>	<b>deaths per 100 fires</b>		<b>injuries per 100 fires</b>	
	<b>1&amp;2 Family Dwellings</b>	<b>Apartments</b>	<b>1 &amp; 2 Family Dwellings</b>	<b>Apartments</b>
Fire Resistive	.60	.60	2.90	5.85
Protected Noncombustible	.68	.70	3.45	6.90
Protected Wood Frame	.71	.70	3.95	6.32
Heavy Timber	.80	.52	2.08	4.30
Protected Ordinary	.80	.84	4.37	6.32
Unprotected Noncombustible	.71	.83	3.00	5.45
Unprotected Ordinary	.92	.97	4.01	6.01
Unprotected Wood Frame	.95	1.07	3.32	5.95
Other Construction Type	1.45	1.91	3.88	5.00

**Table 4** Residential Deaths and Injuries by Construction Type – When Fire Spreads to Entire Structure <sup>22</sup>

<b>Construction Type</b>	<b>deaths per 100 fires</b>		<b>injuries per 100 fires</b>	
	<b>1&amp;2 Family Dwellings</b>	<b>Apartments</b>	<b>1 &amp; 2 Family Dwellings</b>	<b>Apartments</b>
Heavy Timber	1.70	3.35	2.70	5.69
Fire Resistive	2.08	4.10	4.62	18.80
Unprotected Noncombustible	2.23	5.69	4.01	13.15
Protected Wood Frame	2.95	3.28	6.39	13.52
Unprotected Ordinary	2.97	4.00	6.03	13.15
Protected Ordinary	3.00	4.62	6.80	14.30
Unprotected Wood Frame	3.00	4.07	5.31	11.65
Protected Noncombustible	3.72	4.62	5.22	21.00
Other	4.01	15.00	5.60	25.00

The high number of residential fire deaths in apartments

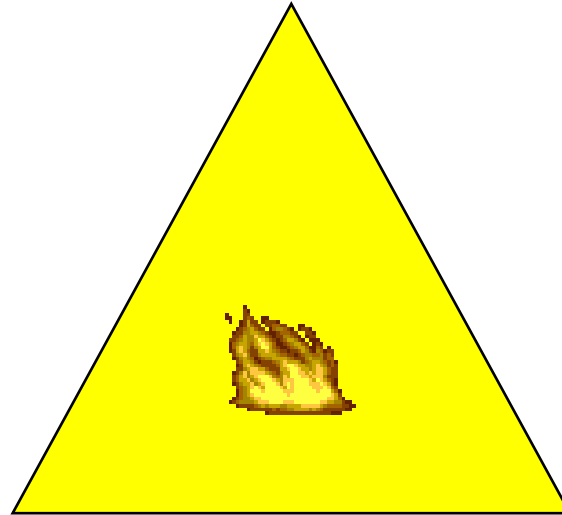


# Requirements for Combustion:

remove any one of these, and, no fire...

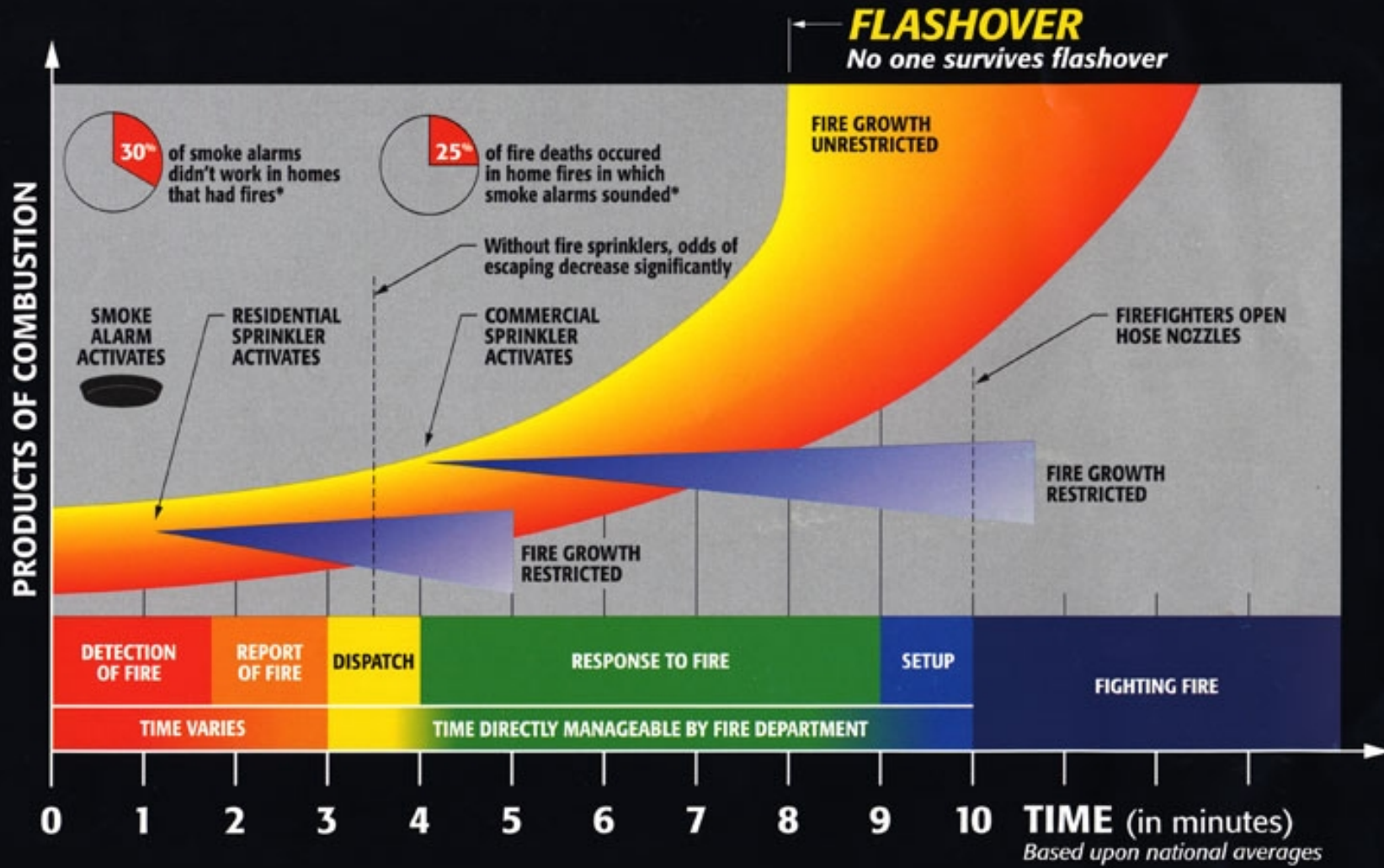
heat

fuel = Building!



oxygen

# TIME vs. PRODUCTS of COMBUSTION





when there are  
fire fatalities in  
residential buildings...

57% of victims are male  
female victims make up 43%

55% occur in a  
bedroom  
51% occur between  
10PM and 6AM

91% involve thermal burns  
and smoke inhalation  
victims that were escap-  
ing or sleeping make up 70%

13% of buildings were  
under 10 years old.  
43% of victims are between  
the ages of 40 and 69.

**Table 2** Annual Fire Loss Record for Single-Family Dwellings – Items First Ignited <sup>22</sup>

<b>Item First Ignited (list not complete)</b>	<b>Deaths Per 100 Fires</b>	<b>Injuries Per 100 Fires</b>
Upholstered Furniture	5.11	9.24
Mattress or Bedding	1.94	7.48
Multiple Forms	1.94	4.47
Gas or liquid	1.47	8.61
Floor covering	1.32	3.88
Structural Members	0.75	1.78



**Table 3** Annual Fire Loss Record for Apartment Buildings  
1-4 Storeys – Items First Ignited <sup>22</sup>

<b>Item First Ignited (list not complete)</b>	<b>Deaths Per 100 Fires</b>	<b>Injuries Per 100 Fires</b>
Upholstered Furniture	4.16	15.73
Mattress or Bedding	2.16	12.21
Multiple forms	1.91	10.00
Interior Wall Covering	1.65	6.53
Gas or liquid	1.56	10.94
Structural Members	1.38	4.94

## Main Issues:

- occupancy type
- occupant load
- building size
- construction type
- exit requirements
- fire resistance ratings
- fire separation





# Exit Requirements:

- You ALWAYS ALWAYS ALWAYS
- Need at LEAST two means of egress from every floor area
- No dead end corridors
- Egress paths must be fire safe/protected
- More exits required for institutional and commercial buildings as they house unrelated occupants

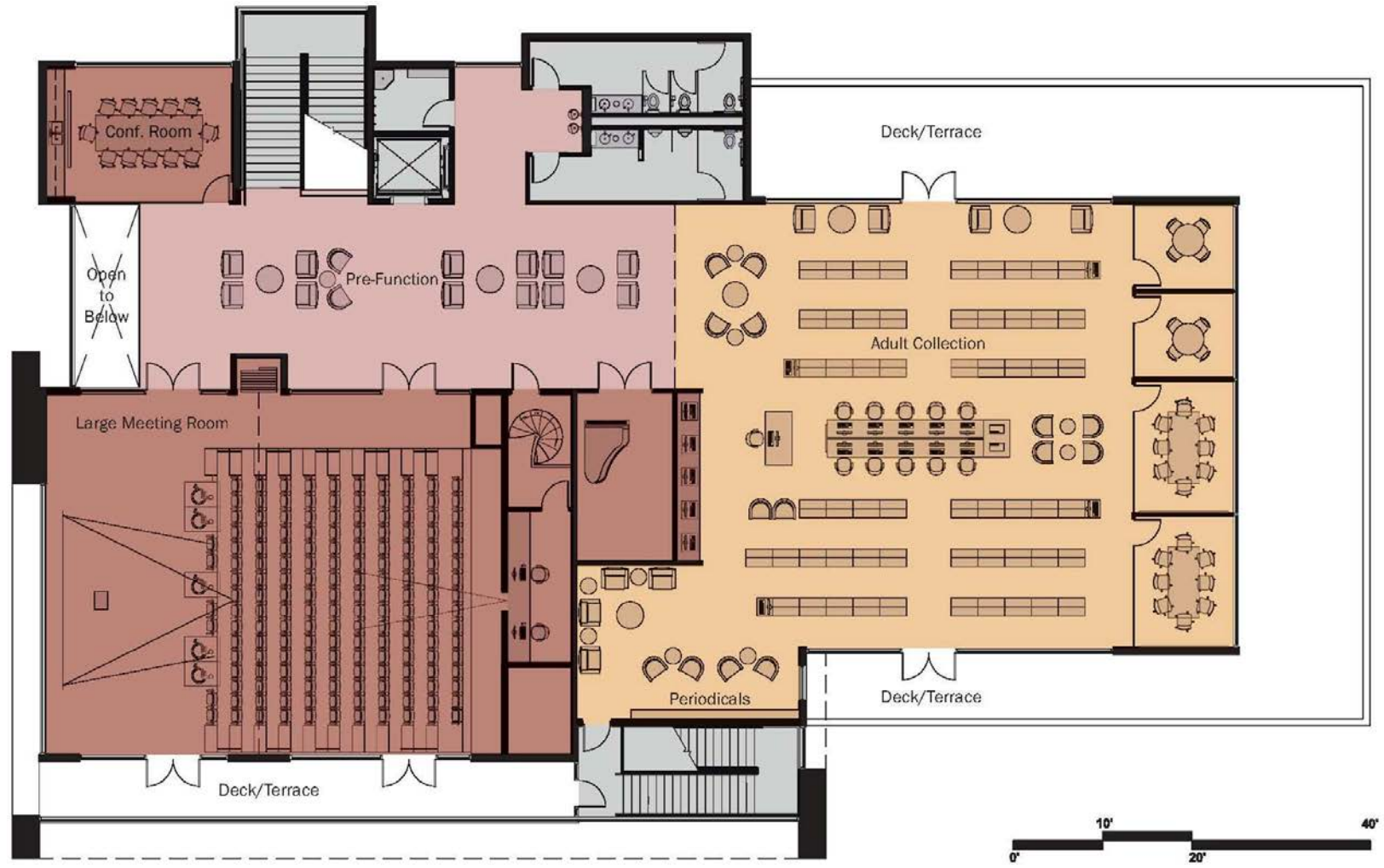




Note! Exit doors in public buildings open **out** in the direction of travel



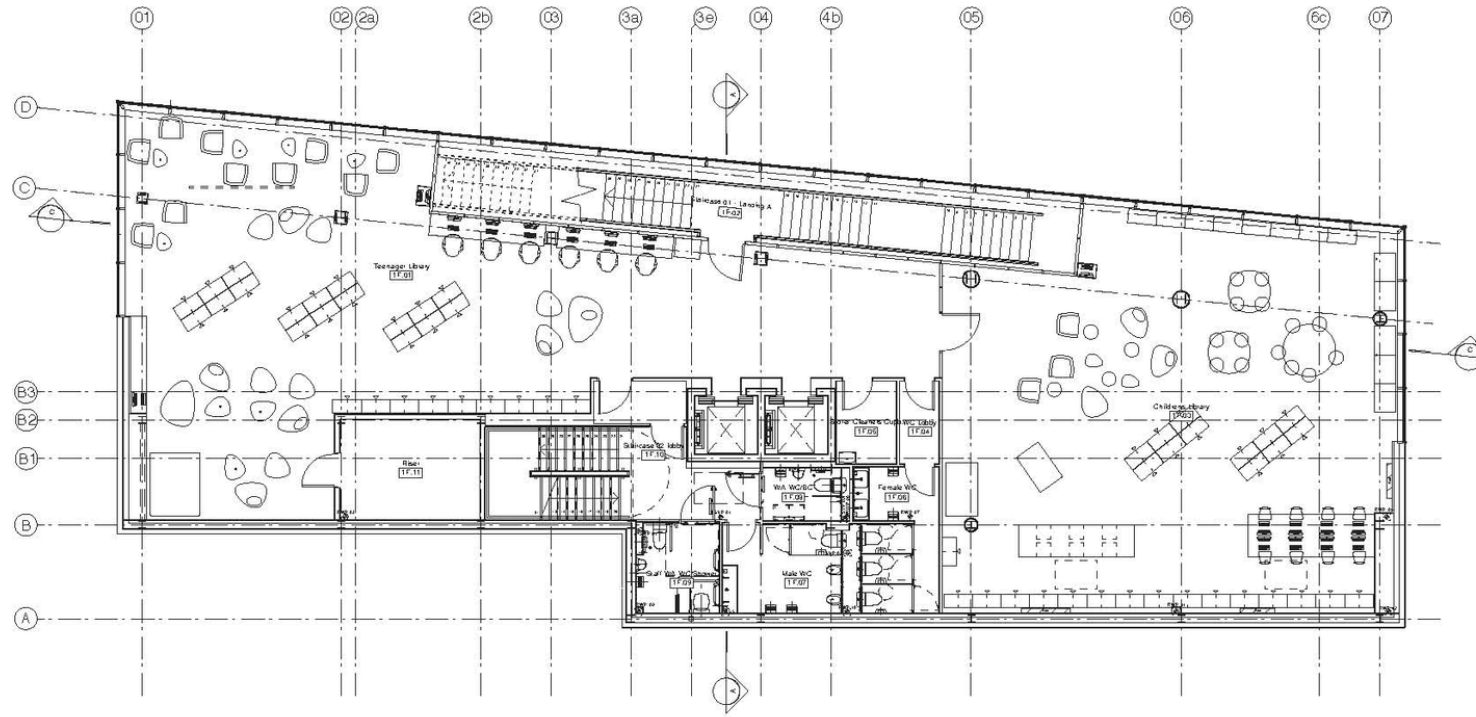
Sample small library: Ground Floor Plan



Sample small library: Second Floor Plan





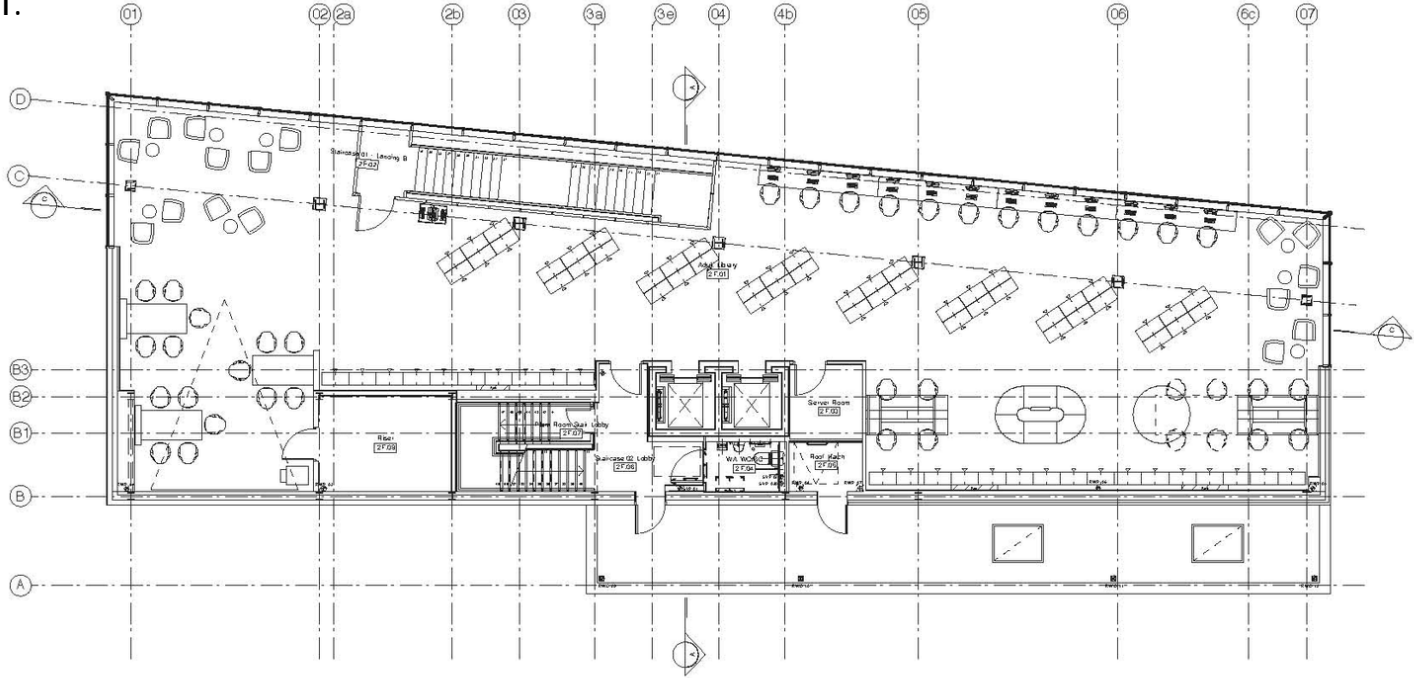


Library with two means of egress -  
one feature stair and one more  
conventional one.

**bisset adams**  
Idea Store Watney Market 1st Floor



Note the feature stair is actually enclosed for safety, but still pretty cool.



## Occupancy Type:

- **occupancy** refers to the main intended use for a building or portion thereof
- can be classified for more than one major occupancy
- most hazardous use determines requirements for entire building, except if located entirely on top of one another
- certain occupancies can NEVER be combined

# Occupancy Type:

• Group	Division	Description
• A	1	Production and viewing of performing arts
• A	2	Not elsewhere classified
• A	3	Arena type
• A	4	Open air
• B	1	Detention occupancies
• B	2	Care and treatment occupancies
• B	3	Care Occupancies
• C		Residential Occupancies
• D		Business and Personal Services
• E		Mercantile
• F	1	High Hazard Industrial
• F	2	Medium Hazard Industrial
• F	3	Low Hazard Industrial



Risk factors determine where a use falls as well as which can or cannot be combined in a single building.

TABLE 4.1

**Classification of buildings**

Occupancy	Group	Division	Risk Factors	Examples
Assembly	A		Evacuation of considerable number of people, often from large spaces	
		1	<ul style="list-style-type: none"> <li>• poor lighting conditions can hinder evacuation</li> </ul>	theatres
		2	<ul style="list-style-type: none"> <li>• good lighting conditions</li> </ul>	schools
		3	<ul style="list-style-type: none"> <li>• well lit</li> <li>• low fire loads</li> <li>• large open spaces where smoke can dissipate</li> </ul>	arenas
		4	<ul style="list-style-type: none"> <li>• open air assembly area</li> <li>• low risk of being trapped</li> </ul>	bleachers
Care and Detention	B		Acute evacuation problems because of restricted mobility of occupants	
		1	<ul style="list-style-type: none"> <li>• occupant movement is restricted by security measures</li> </ul>	penitentiaries
		2	<ul style="list-style-type: none"> <li>• lack of occupant mobility</li> <li>• require safe area to permit two stage evacuation</li> <li>• need to contain fire to area of origin</li> </ul>	hospitals

Residential	C		<ul style="list-style-type: none"> <li>• people may be sleeping when the need for emergency evacuation arises</li> <li>• significant delays in people becoming aware of a fire and evacuating the building</li> <li>• occupants must be protected while preparing to evacuate</li> </ul>	apartments hotels
Business	D		<ul style="list-style-type: none"> <li>• occupants are fully alert</li> <li>• relatively low fire load</li> <li>• no major evacuation problems</li> </ul>	offices
Mercantile	E		<ul style="list-style-type: none"> <li>• high combustible content which can result in severe fire with heavy smoke</li> <li>• occupants are aware</li> <li>• no unusual evacuation problems</li> </ul>	department stores
Industrial	F	1	<ul style="list-style-type: none"> <li>• highly combustible and flammable or explosive substances</li> </ul>	distilleries
		2	<ul style="list-style-type: none"> <li>• medium hazard, no explosive substances</li> </ul>	factories
		3	<ul style="list-style-type: none"> <li>• low hazard, can still have high fire load</li> </ul>	warehouses

# Occupant Load:

- is the number of people is an estimate of the expected maximum use of a building or floor area, for the most hazardous use
- provides a basis to calculate the number of exits required and the width of those exits
- can be used as a 'rule of thumb' basis for determining floor area requirements when designing



**TABLE 1 Occupant Load**

Type of Use of Floor Area or Part Thereof	Area per Person (m <sup>2</sup> )
<b>Assembly Uses</b>	
space with fixed seats	See Note (1)
space with nonfixed seats	0.75
spaces for theatrical performances	0.75
space with nonfixed seats and tables	0.95
standing space	0.40
stadia and grandstands	0.60
bowling alleys, pool and billiard rooms	9.30
classrooms	1.85
school shops and vocational rooms	9.30
reading or writing rooms or lounges	1.85
dining, beverage and cafeteria space	1.20
laboratories in schools	4.60
<b>Institutional Uses</b>	
treatment and bedroom areas	10.00
detention quarters	11.60
<b>Residential Uses</b>	
dwelling units	See Note (2)
dormitories	4.60
<b>Business and Personal Service Uses</b>	
personal service shops	4.60
offices	9.30

**TABLE 1 Occupant Load**

Type of Use of Floor Area or Part Thereof	Area per Person (m <sup>2</sup> )
<b>Mercantile Uses</b>	
basements and first storeys	3.70
second storeys having a principal entrance from a parking area	3.70
other storeys	5.60
<b>Industrial Uses</b>	
manufacturing or process rooms	4.60
storage garages	46.00
storage spaces (warehouse)	28.00
aircraft hangars	46.00
<b>Other Uses</b>	
cleaning and repair of goods	4.60
kitchens	9.30
storage	46.00
public corridors intended for occupancies in addition to pedestrian travel	3.70

Notes: (1) The occupant load is based on the number of fixed seats provided.

(2) The occupant load for dwelling units is based on 2 persons per bedroom or sleeping area.

Source: National Building Code of Canada

# Construction Types:

Two Primary types of construction:

**COMBUSTIBLE:** i.e. materials that burn easily and provide fuel for a fire (wood...)

**NON-COMBUSTIBLE:** i.e. materials that do not burn or act as fuel (these include steel and concrete)





Construction materials are *supposed* to stop the spread of fire from one house/building to the next.

We also use *space between buildings* to slow the spread of fire (setbacks).





# Combustible Construction:

- typically light wood frame construction or Post and Beam
- only able to be used on buildings less than 6 storeys and usually less than 600 m<sup>2</sup>.
- used on buildings which require a fire resistance rating of 3/4 hour or less



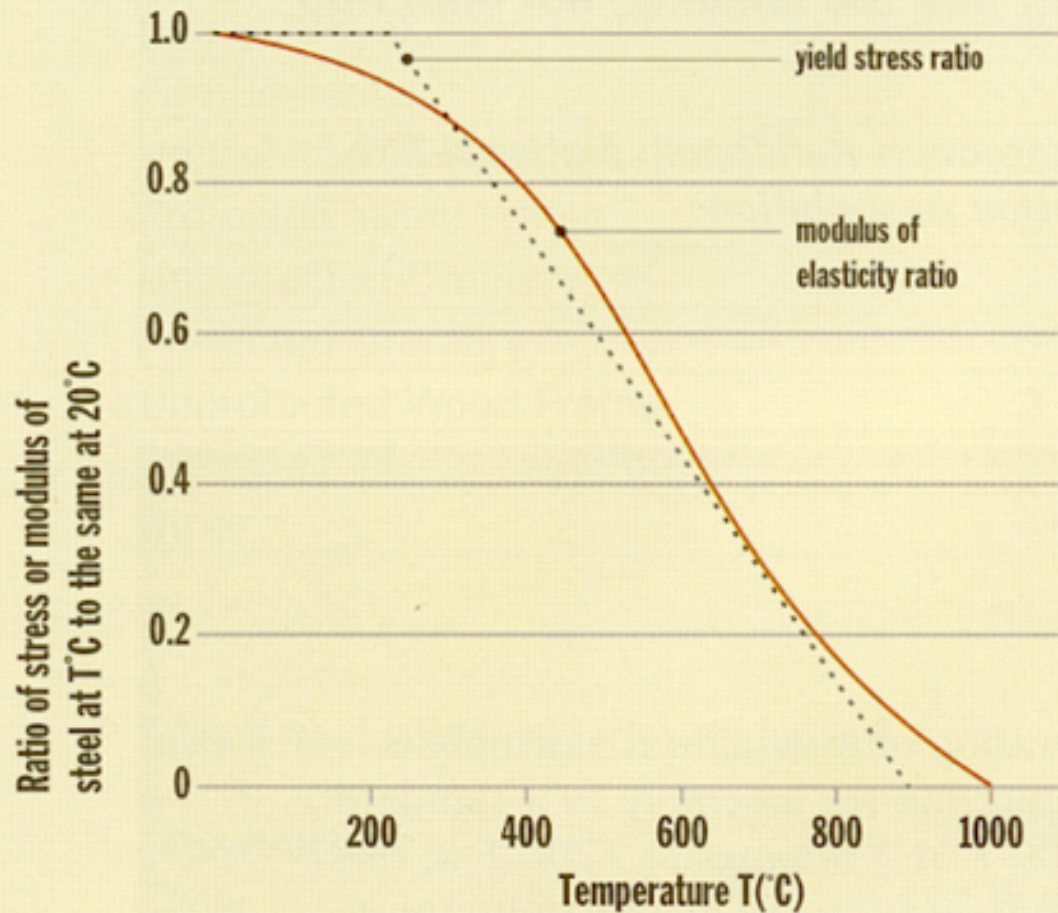
# Non-Combustible Construction:

- used on all other types of buildings
- used for fire resistance classifications of 3/4 hour or greater
- unprotected steel can only be used for ratings of 3/4 hour
- 1 hour or greater requires the use of concrete structural products or protection on steel products (gypsum, concrete, **intumescent** coatings or other fireproofing)





**Figure 5** Steel Loses Strength at Elevated Temperatures



Source: *Fire Engineering Design Guide*,  
University of Canterbury, New Zealand, 1994

The need to protect steel led to an increased use of reinforced concrete

Revisiting this now as concrete has such a high environmental cost.





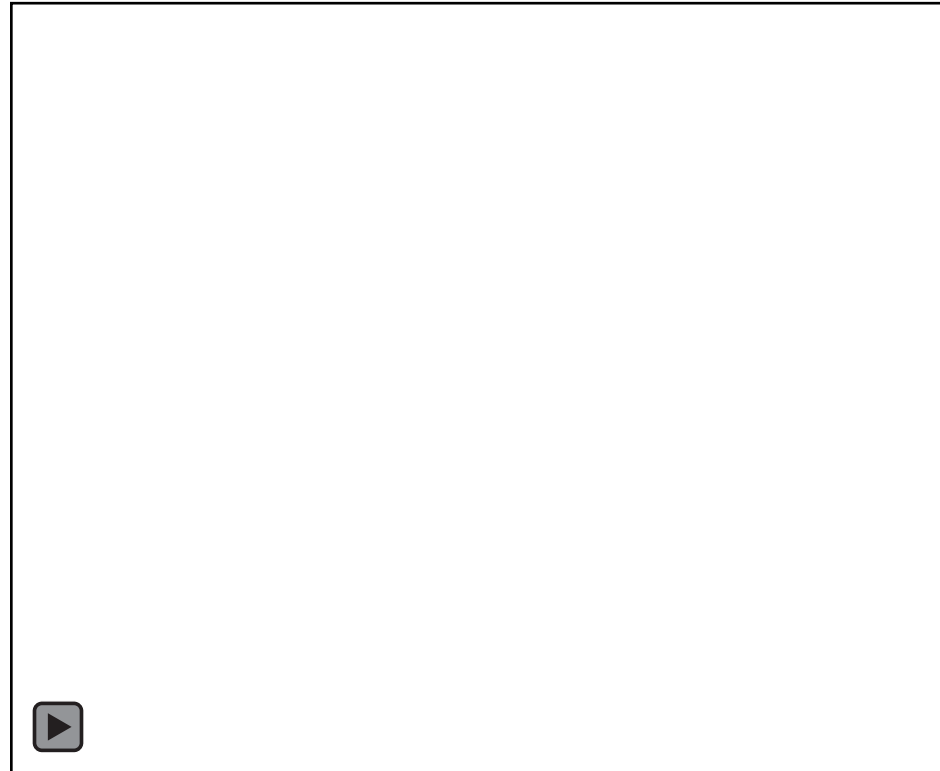
Galpão USP - 2002 - São Paulo - steel beams have melted





Intumescent coatings were used on the exterior “legs” at OCAD and on this truss in the Bloomberg Tower in NYC.

# Intumescent coatings



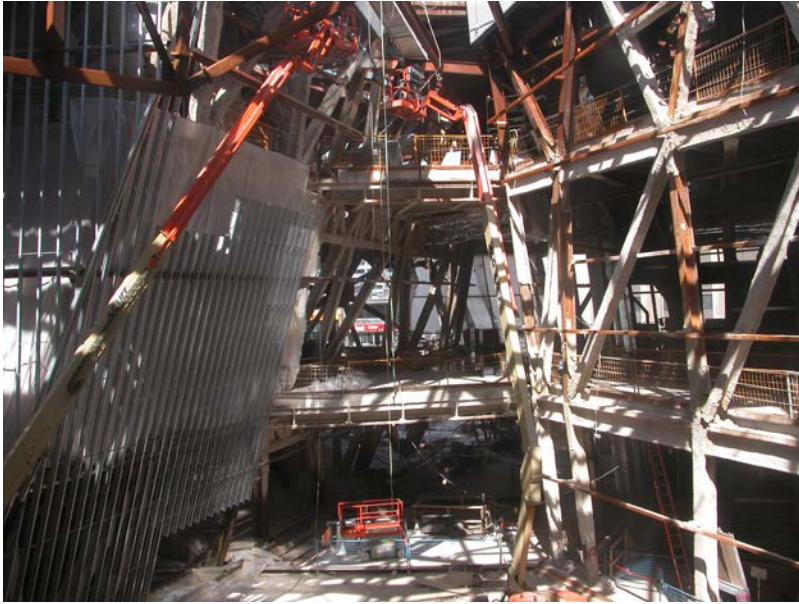
Film of intumescent coating  
under a fire condition.





The texture of the intumescent coating is akin to an orange peel.

It can be shop or site applied and of differing materials.



Spray on cementitious fireproofing is used in areas where the steel will be concealed from view. It is usually covered with gypsum board, which also improves its fire resistance rating.

# Building Size:

- a limit on the maximum area and number of floors based on:
  - building use (occupancy type, hazard level)
  - construction type (combustible/non)
  - sprinklered or not (sprinklering allows for a doubling of area allowed)
  - access for fire fighting (number of streets the building faces, hydrant location, standpipes...)



# Determining Maximum Building Area:

i.e. Maximum Building Area Group C up to 3 Storeys

No. of  
Storeys

Maximum Area (m<sup>2</sup>)

Facing 1 Street

Facing 2 Streets

Facing 3 Streets

1	1,800	2,250	2,700
2	900	1,125	1,350
3	600	750	900

# Building Height:

- taller buildings are more difficult to evacuate quickly so have more stringent limitations
- the gross floor area of single storey buildings will be greater than the g.f.a. of a multi storey building for the same use on the same site
- tall buildings require internal fire fighting equipment as trucks and ladders have a limit to the heights they can reach (usually 6 floors)

Guangzhou IFC, Guangzhou, China

Lever House, NYC





Shanghai Tower, Shanghai, China





How high can the fire equipment reach?

Affects construction type (3 storeys and less vs more than 3 storeys)

Different fire departments have different truck reaches







Firefighting from outside is less effective than fighting the fire from inside

Hence the need for sprinklers and interior hoses on larger buildings







**Figure 2** Four Storey Wood Frame Residential Construction

Typically, buildings under 4 storeys can be constructed of more combustible or “less safe” construction due to the ease of evacuation in the case of fire.

This has recently been increased to 6 storeys with added fire protection and sprinklers.



Schools practice with fire drills so have more lenient construction requirements.



# Fire Drill Safety Rules

- ★ Listen carefully to directions.
- ★ Quietly line up.
- ★ Walk carefully out of the building to your assigned place.
- ★ Stay with your class at all times.
- ★ Wait with your teacher until it is safe to return to your classroom.







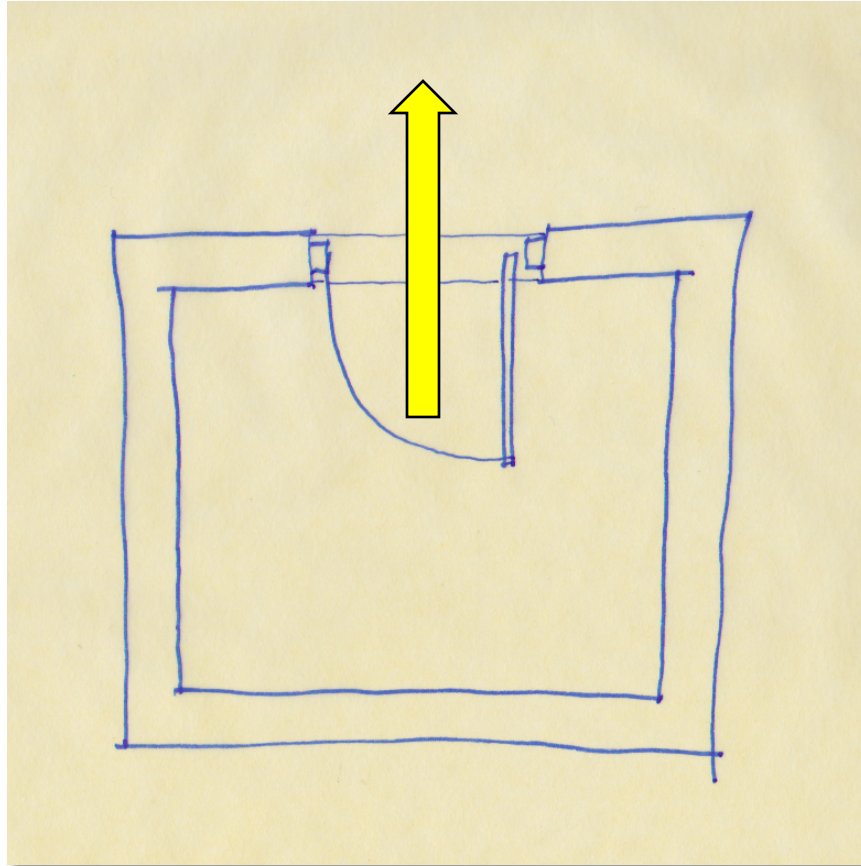
Where IS the fire exit sign???



# Exit Requirements:

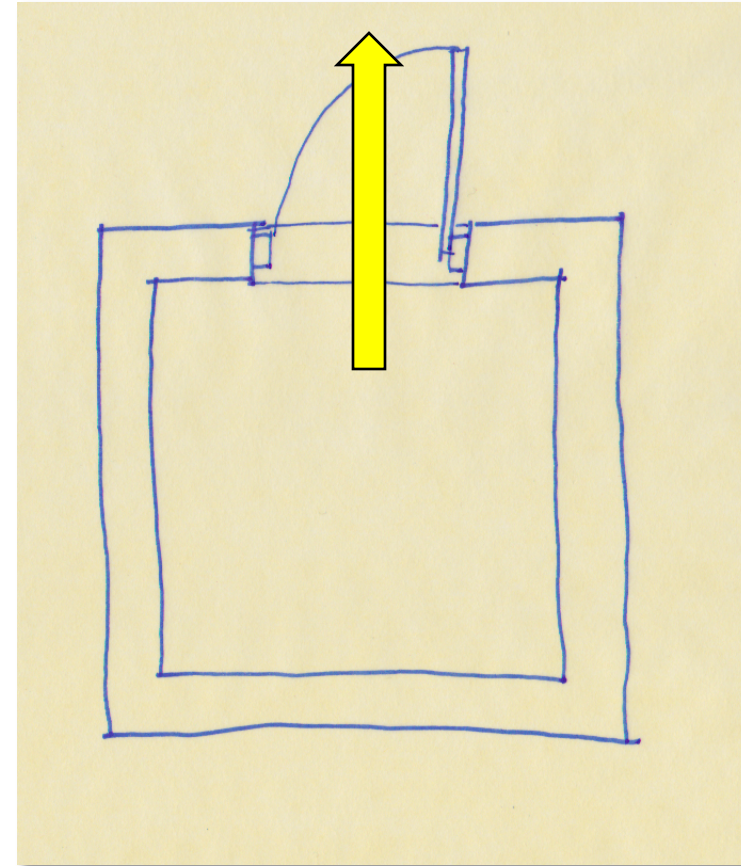
- number and type dependent on occupancy type and load
- i.e. greater risk, more people, more exits
- every floor area must have 2 exits
- travel distance to the exit is limited
- dead end corridors (more than 6m) not permitted
- exits must be fire separated from the rest of the building they are serving

- Low number of people exiting
- Door opens in (in case of obstruction outside)

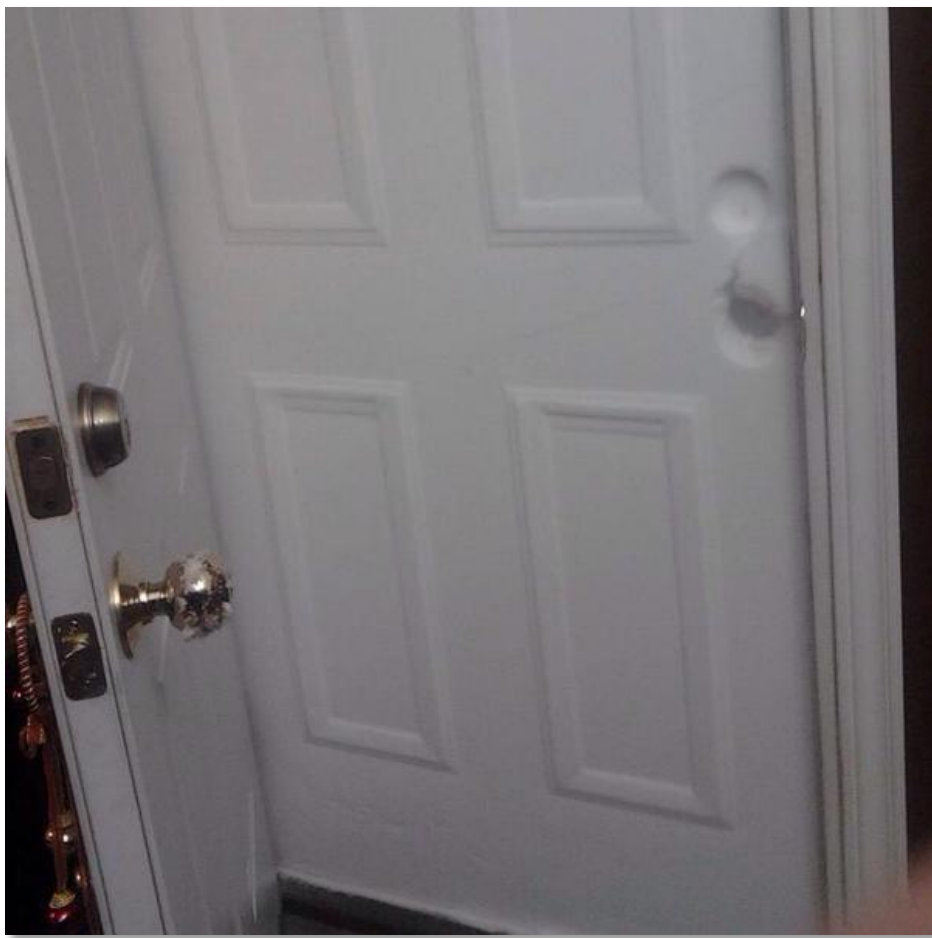


Residential/Single Family

- High number of people exiting (pushing and shoving!)
- Door opens out to prevent crushing



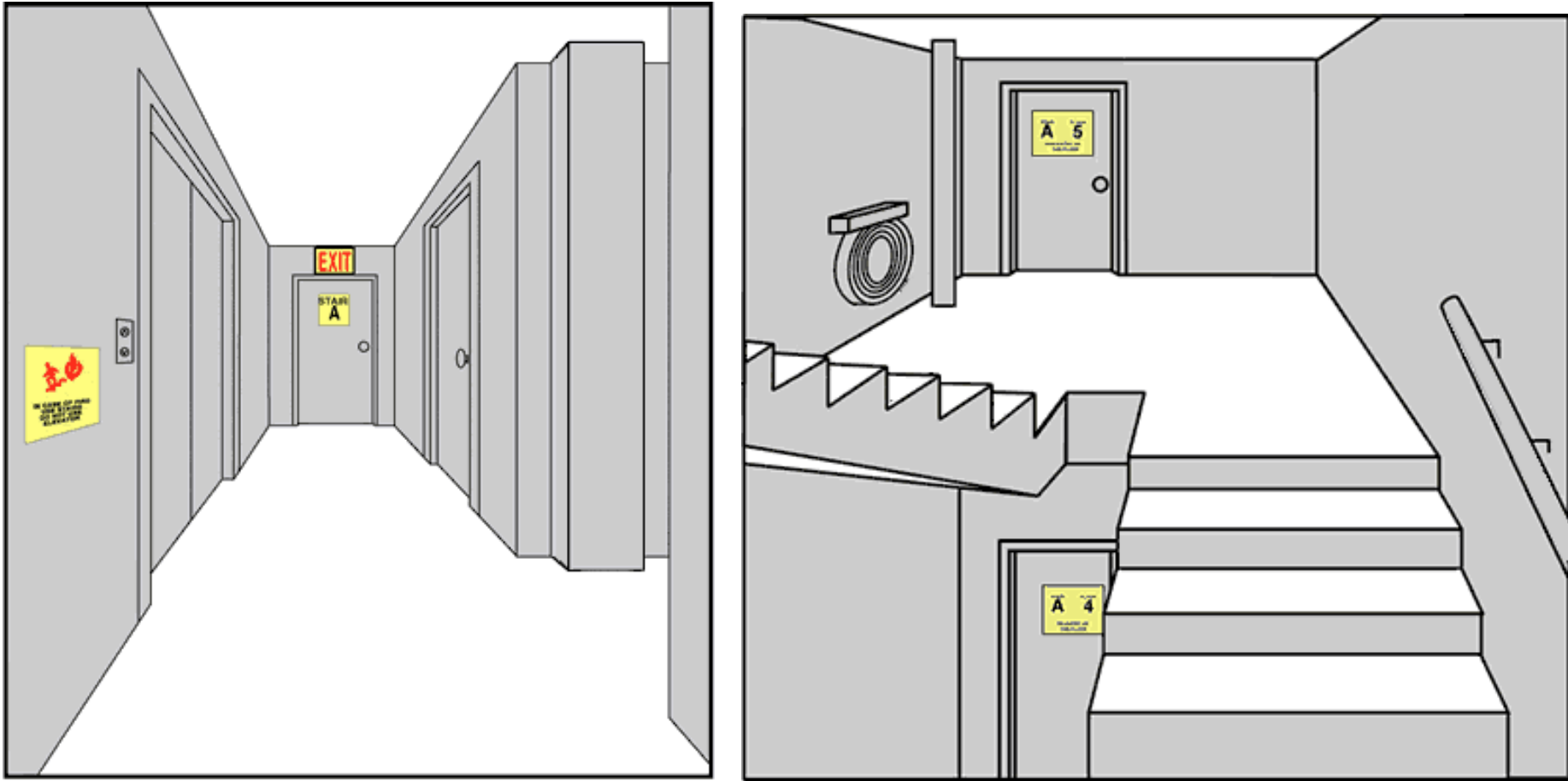
Commercial/Institutional



Buffalo snow storm 2014  
The reason residential  
exit doors open inward.



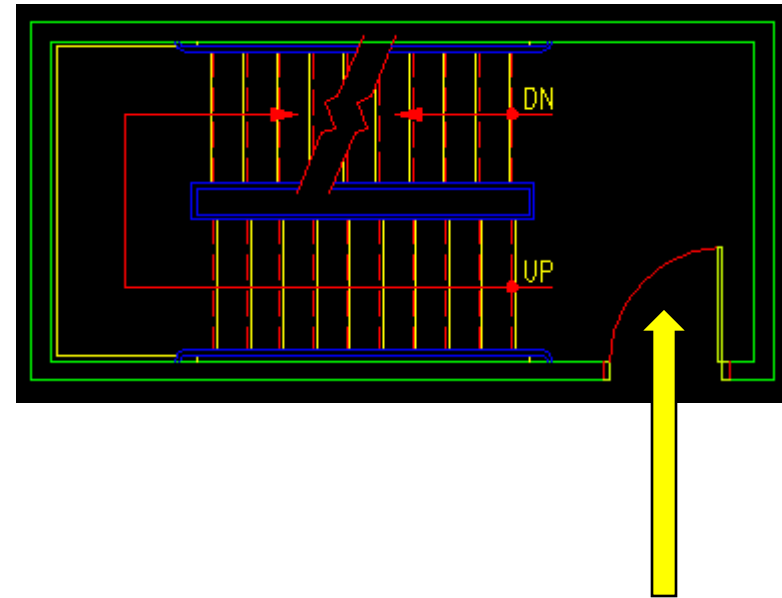




Exits must be clearly marked with “internationally recognized” signage.

# Fire Stairs

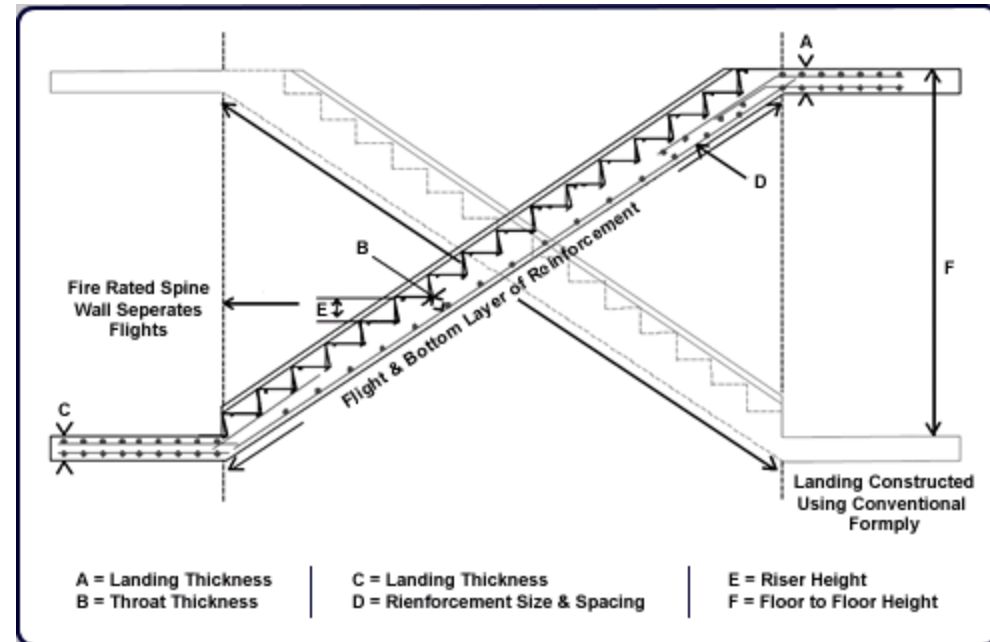
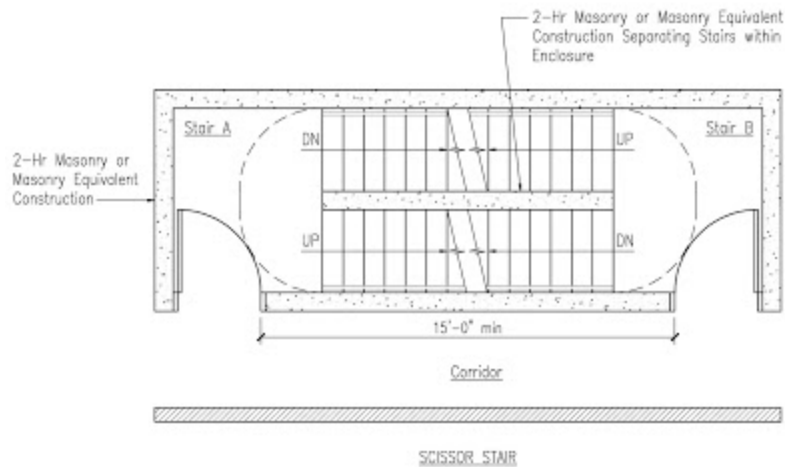
- Must be a safe route
- Minimal glazing allowed into the building
- Door opens into the stair
- Enough space between door and riser to allow someone to pass by (30cm minimum)



- People exiting into stairwell
- Door opens IN

# Scissor Stairs

- Ingenious way to intertwine two fire egress stairs
- But illegal now in some jurisdictions





With rare exceptions (like in stand alone houses), almost all building areas require at least 2 means of egress.

In buildings over one floor in height this normally means at least 2 sets of fire safe stairs.

**What is a fire safe stair???** One that is enclosed. Very little glass (often only a wee pane in the door). Has doors that open into the stairwell. Is pressurized so that if the door is left open no smoke can enter. Usually provides an exit directly to the exterior of the building.

**i.e. It is really boring architecturally speaking -- but SAFE.**



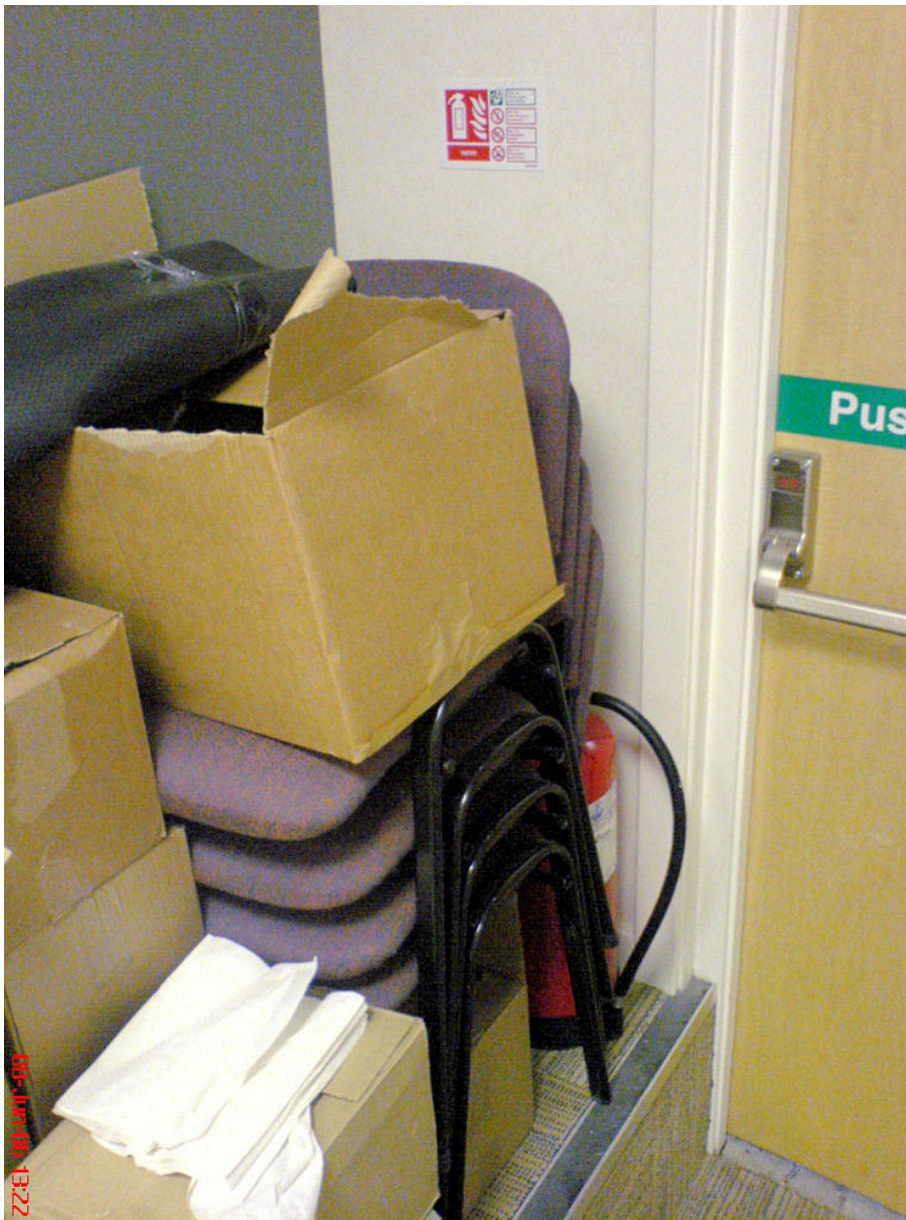


Fire exit doors need clear signage, panic hardware and are also fire rated. They may only have a small area of wired glass.





Fire exit doors and extinguishers need to be kept unlocked and unblocked.





## Exit through lobby:

- one of the two exits may pass through a lobby space IF:
  - lobby floor not more than 4.5m above grade
  - path of travel does not exceed 15m
  - rooms adjacent to lobby are fire separated (ie. doors and walls)
  - lobby is not part of an interconnected atrium space



Fire escapes are no longer permitted as a means of egress in NEW construction.



A major part of the risk here is the spread of the fire through the windows out onto people trying to exit on the fire escape.

To make it safe they would have to eliminate the windows, which rather defeats any advantage.





# Fire suppression systems:

- Smaller residential buildings require smoke detectors on each floor
- Larger buildings (and all buildings over 6 storeys) must be equipped with fire suppression systems
  - Must have sprinkler system
  - Must have fire hose cabinets on each floor
  - Must have exterior standpipes
- Very tall buildings must have their own water supply located at the top of the building to be able to use gravity feed in case of a fire



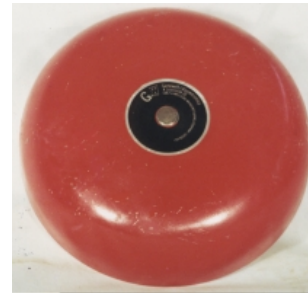


The majority of tall buildings need to hold fire fighting water as it is too demanding to pump it.





Smoke detectors



Fire alarms

Extinguishers  
and fire  
fighting  
equipment



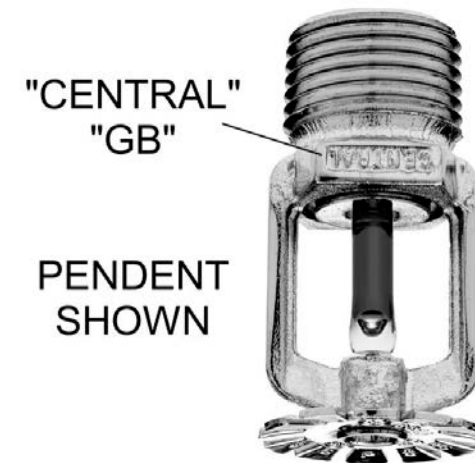




A special wall mounted head that has a deflector to spray water down.

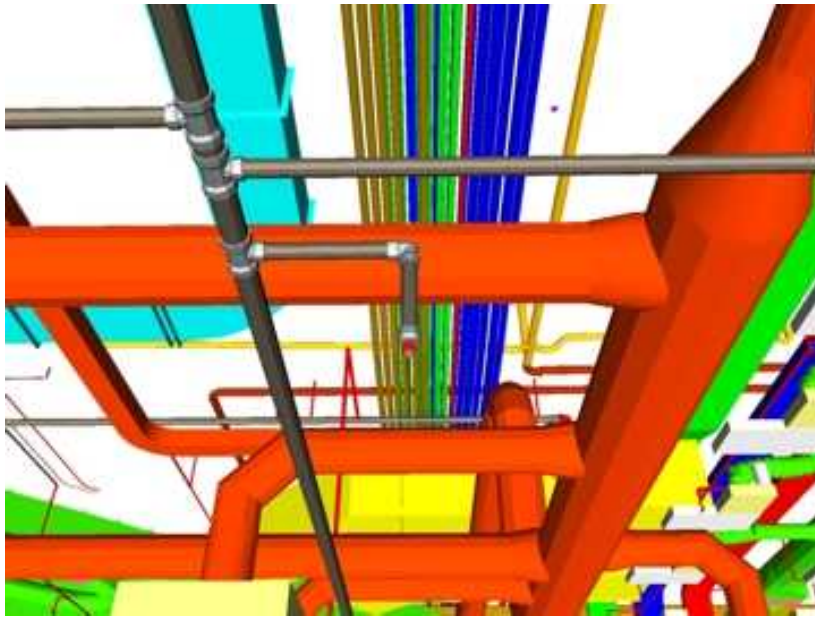


Sprinkler head have a fusible (melting) link that activates the water flow and a rotating device to spray the water.



"CENTRAL"  
"GB"

PENDENT  
SHOWN



The design of a sprinkler system for fire suppression.







The distance in minutes from a fire station affects construction requirements.

Rural locations that depend on volunteer fire departments need increased time to access the fire.





# Travel Distance:

- In addition to having 2 means of egress from each floor they must also be a certain distance apart
- Depending upon the layout and occupancy, MAXIMUM travel distances are set by the code
- If a floor plan is “open” with partitions that are not full height, different rules are applied than when designing for corridors with individual offices.
- This may require more than two stairs

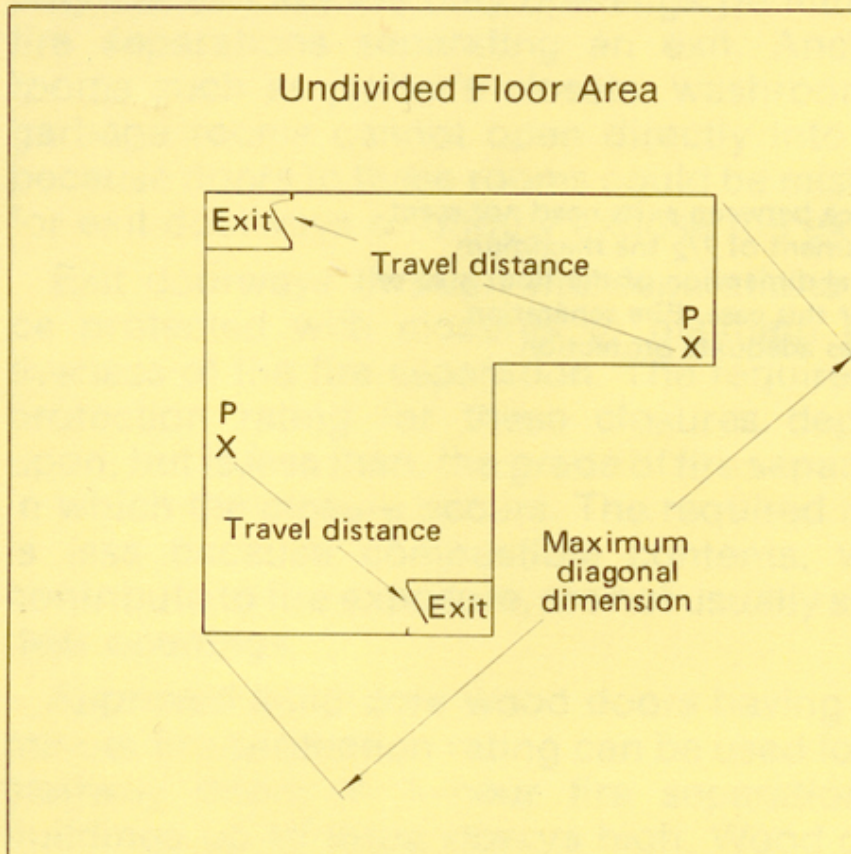
**TABLE 2 Floor Area and Travel Distance**

Occupancy of Floor Area	Maximum Floor Area (m <sup>2</sup> )	Maximum Travel Distance (m)
Group A	150	15
Group B	75 <sup>(1)</sup>	10 <sup>(1)</sup>
Group C	100 <sup>(1) (2)</sup>	15 <sup>(1) (2)</sup>
Group D	200	25
Group E	150	15
Group F, Division 2	150	10
Group F, Division 3	200	15

Notes: (1) Single exit is permitted only when such exit is an exterior door not more than 1.5 m above adjacent ground level.

(2) See Article 3.3.4.3. for dwelling units.

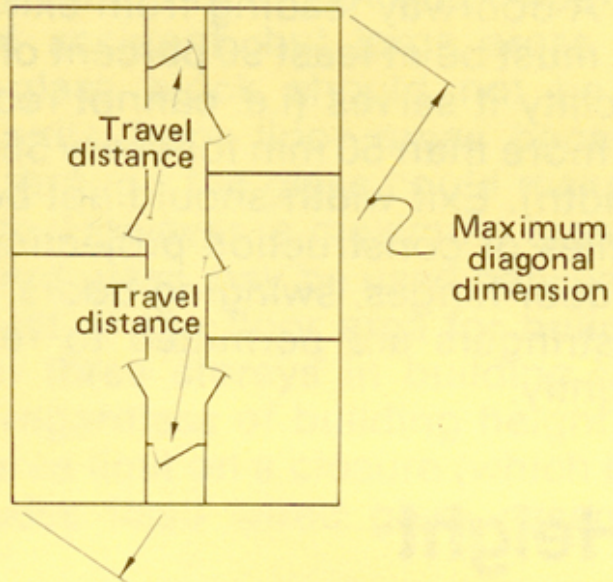
**FIGURE 1** Travel Distance and Separation of Exits



Travel distance from arbitrary points within a floor area, such as points "P", is measured along the path of travel to the nearest exit. The longest travel distance within a floor area must not exceed distances listed in Subsection 3.4.2. In addition, exits must be as far apart as practicable. Distance between exits must be  $\frac{1}{2}$  the maximum diagonal dimension of the floor area or 9 m, whichever is greater.

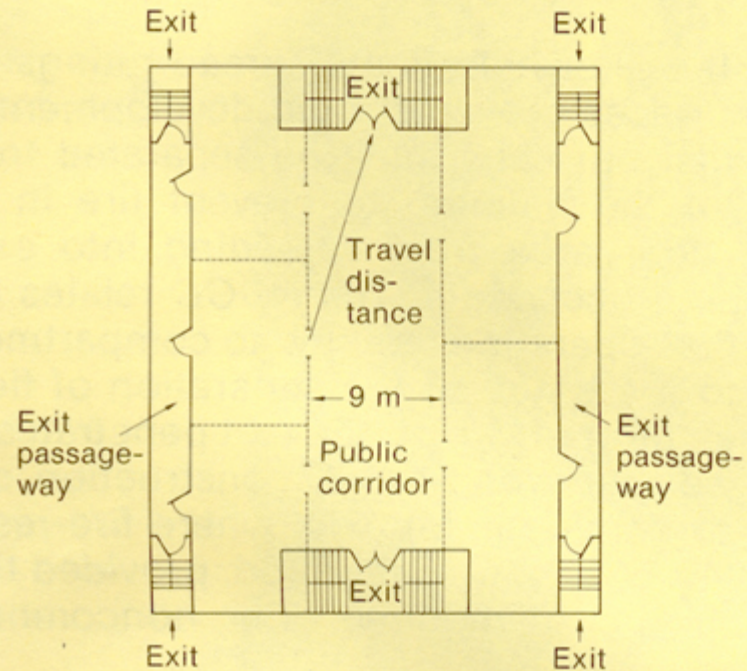


Public Corridor Divided from  
Floor Area by rated  
Fire Separations



When a floor area has been subdivided by at least  $\frac{3}{4}$ -hour fire separations to serve more than one tenant, the travel distance is measured along the path of exit travel within the public corridor from the door of the room or suite to the nearest exit. Again, the longest travel distance must not exceed distances listed in Subsection 3.4.2. Also, exits must be as far apart as practicable. The least distance between exits should be  $\frac{1}{2}$  the maximum diagonal dimension of the floor area, but need not exceed 9 m.

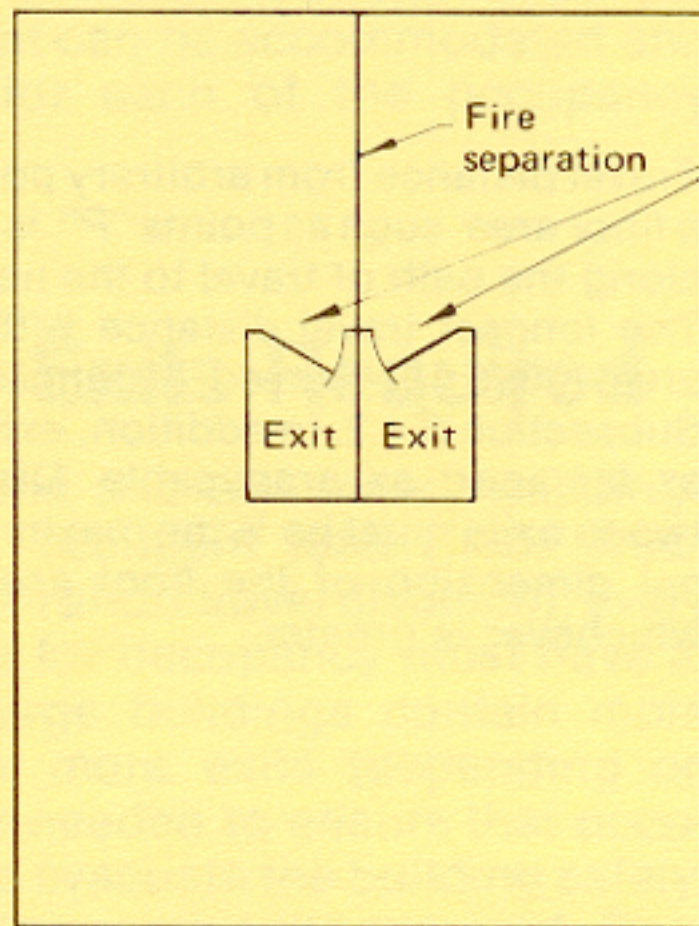
Public Corridor *not* Divided from  
Floor Area by rated Fire Separations  
(e.g., Shopping Mall)



When a floor area is not subdivided by rated fire separations and is served by a 9 m wide public corridor, the travel distance is measured along the path of exit travel within the public corridor from the door of the room or suite to the nearest exit. The maximum travel distance in the public corridor is 60 m. Also, if more than one egress door is required from a room or suite, no more than  $\frac{1}{2}$  the required egress doorways may open into the public corridor. The building must be sprinklered, and ceiling height in the public corridor cannot be less than 4 m above the floor.



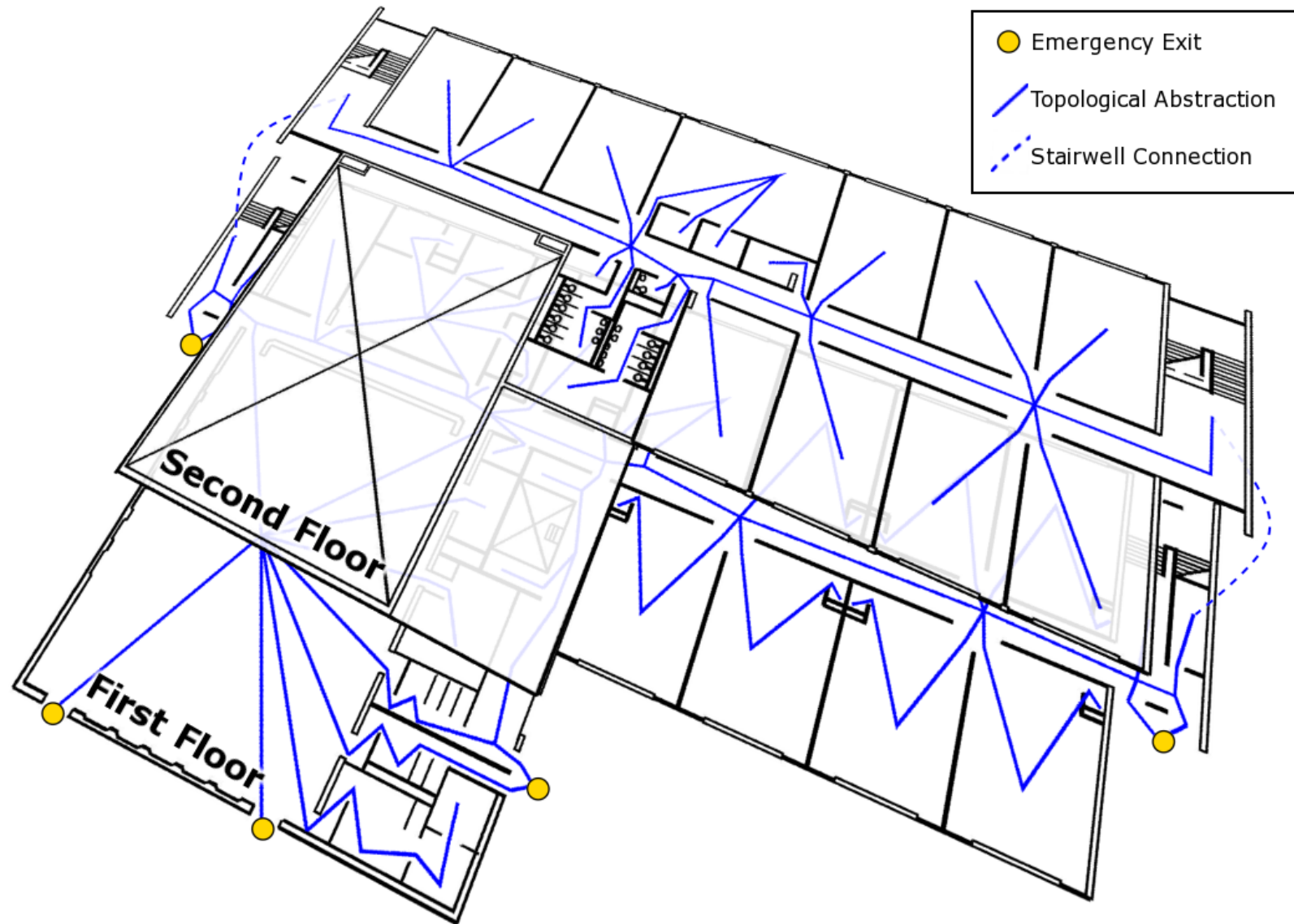
**FIGURE 2 Exception for Separation of Exits**



Distance between exits need not meet requirement of  $1/2$  the maximum diagonal dimension of the floor area or 9 m for this case. Fire separation provides adequate protection.

Partially Divided Floor Area





Architects must plan for escape routes that are neither too long nor too complicated.

# Spatial Separation:

- separation of buildings to isolate them from one another and to control the spread of fire by either:
  - physical space between buildings, including control over openings and finishes
  - physical barrier (wall) between buildings (firewall) or areas within a building (fire separation)

# Fire Separation:

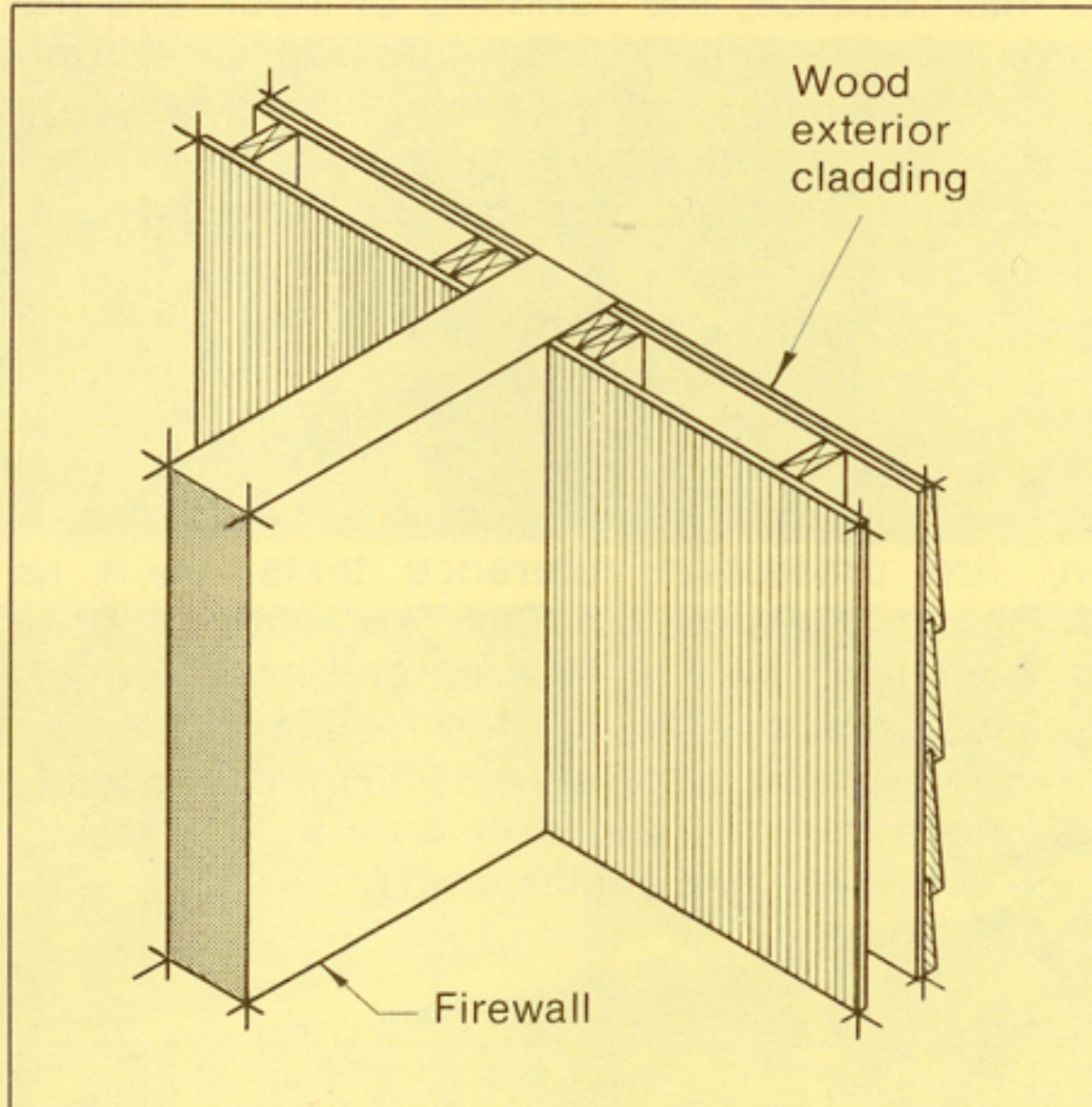
- is any wall, partition or floor assembly designed and built to prevent the spread of fire by restraining the passage of smoke, heat, gases and flame between compartments within one building
- assigned a fire resistance rating as required by the nature of the adjacent spaces



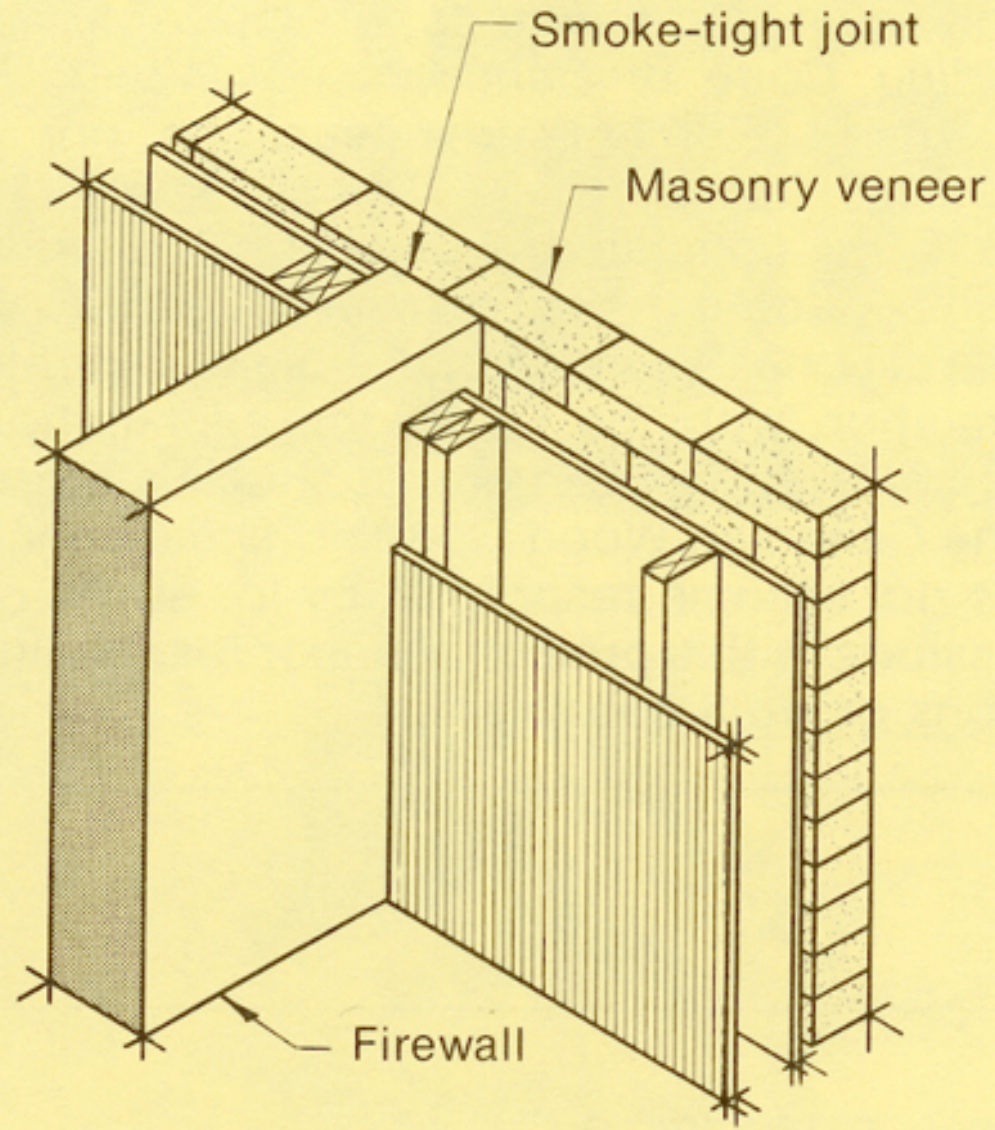
# Firewalls:

- are special fire separations -- continuous walls of masonry or concrete -- that prevent fires from within one structure from spreading to another structure
- must allow building to break away in a fire without destroying the integrity of the firewall
- can be used to divide a large building into smaller building areas
- fewer and more specially designed openings are only allowed

**FIGURE 15 Exterior Wall—Firewall Junctions**

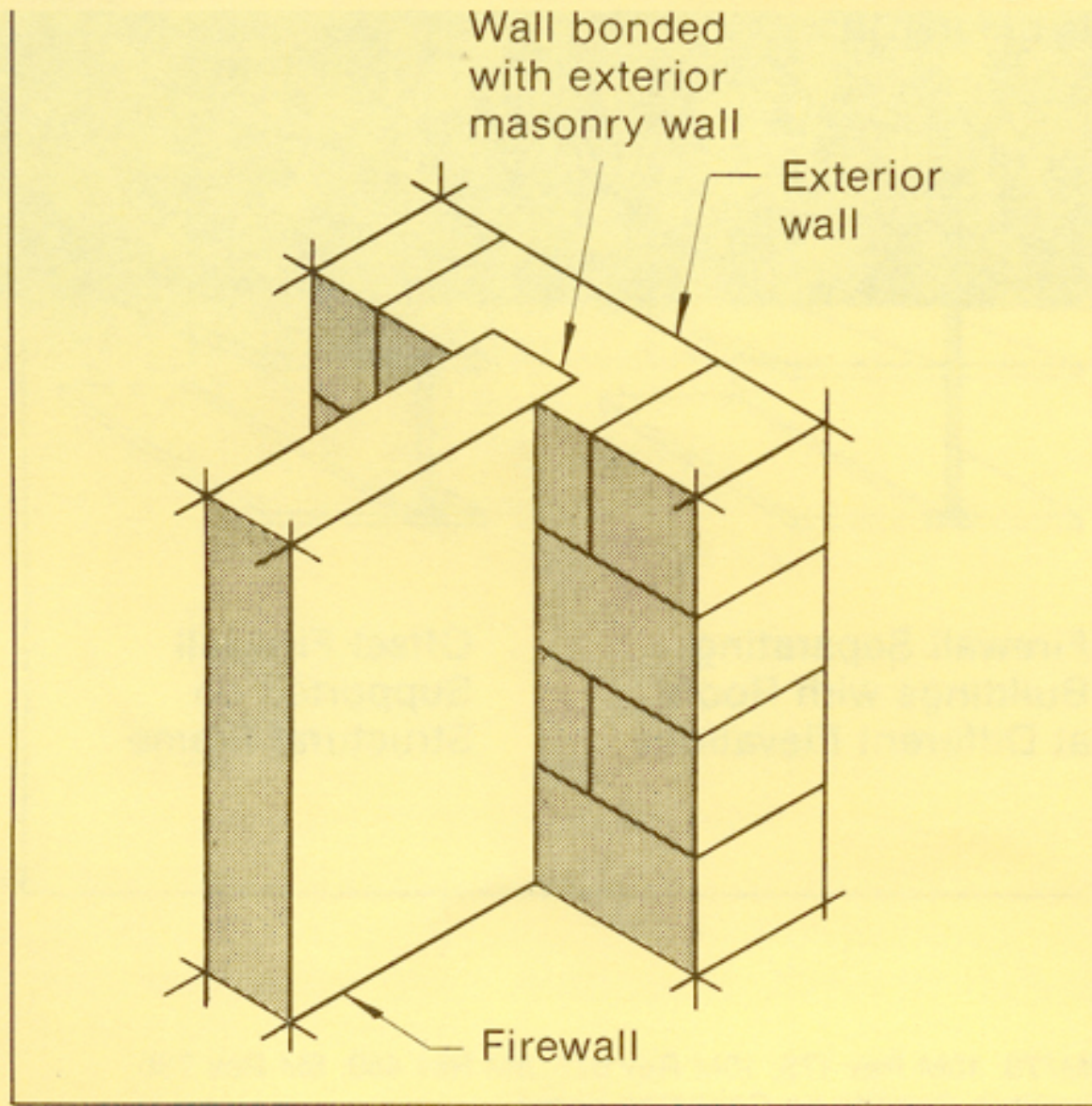


**FIGURE 15 Exterior Wall—Firewall Junctions**

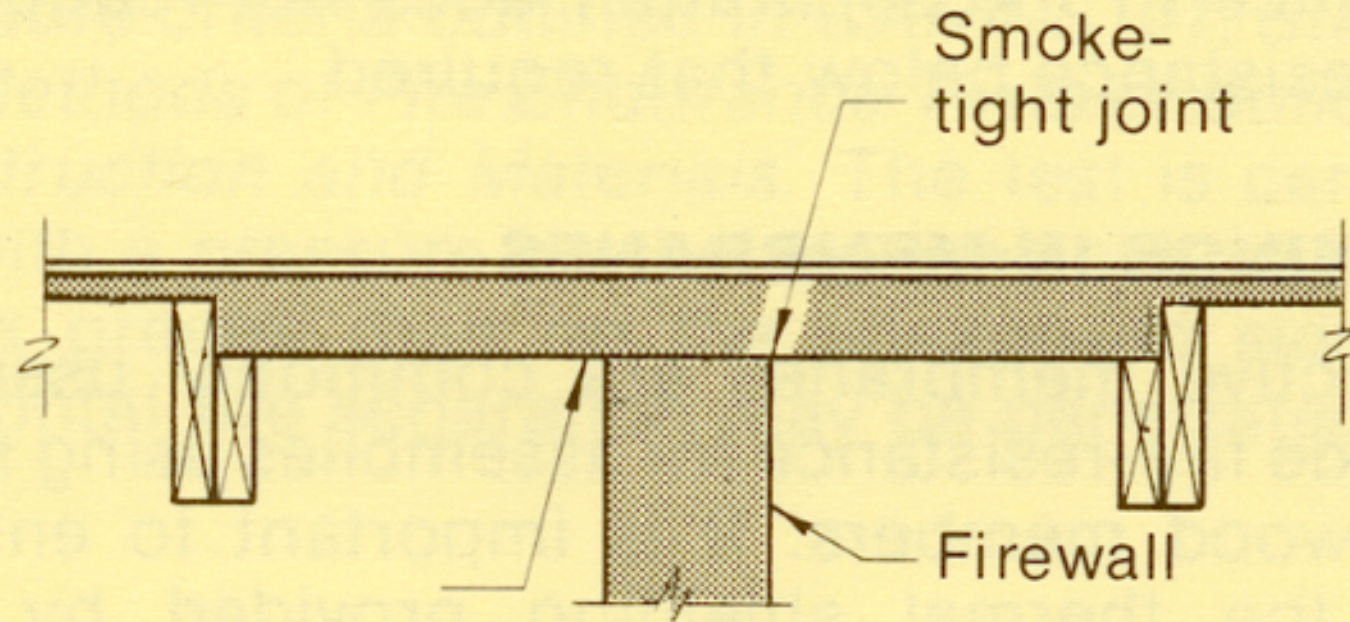




**FIGURE 15 Exterior Wall—Firewall Junctions**



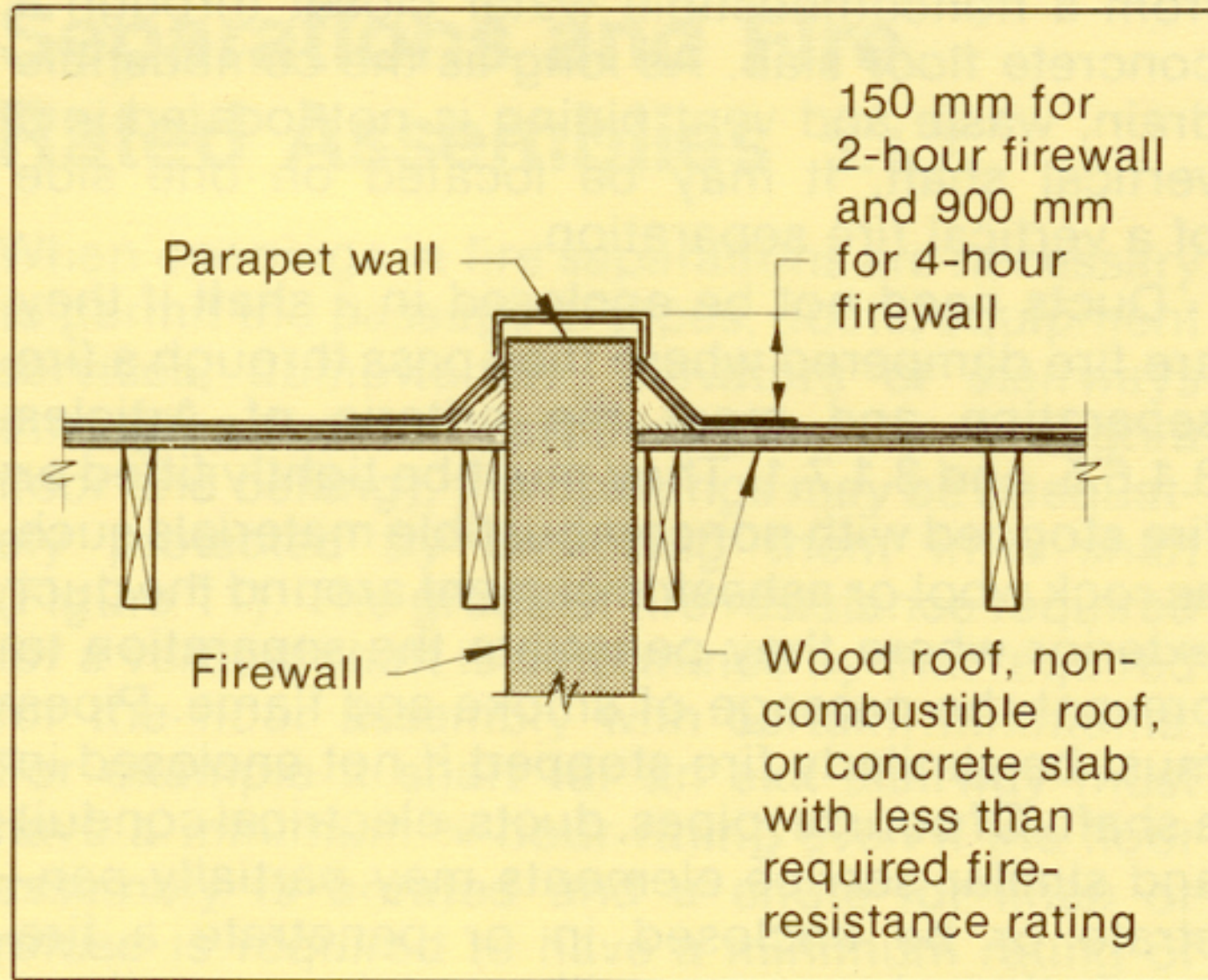
**FIGURE 13 Firewall Without Parapet**



Reinforced concrete roof slab must have a minimum of 1-hour fire resistance with 2-hour firewall; 2-hour with 4-hour firewall.



**FIGURE 12 Firewall With Parapet**





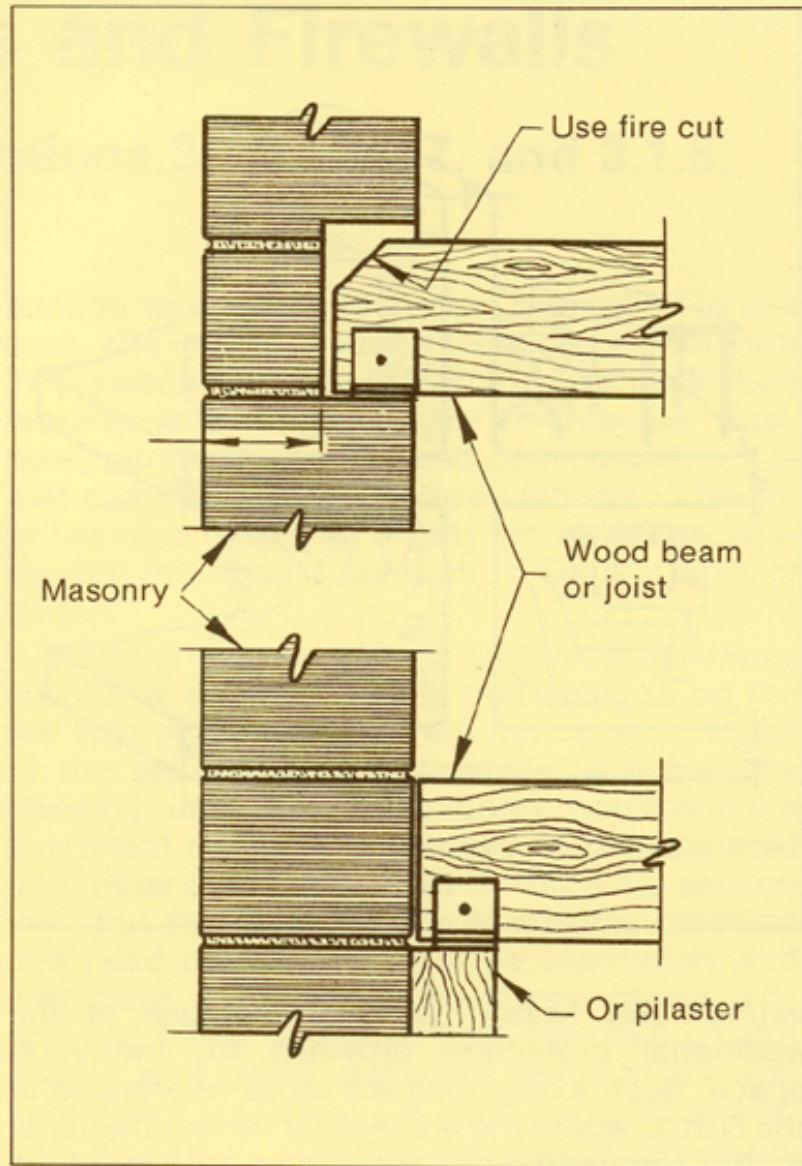


The concrete block firewall between these units is not long enough to meet the brick veneer and stop the flow of air between the units.

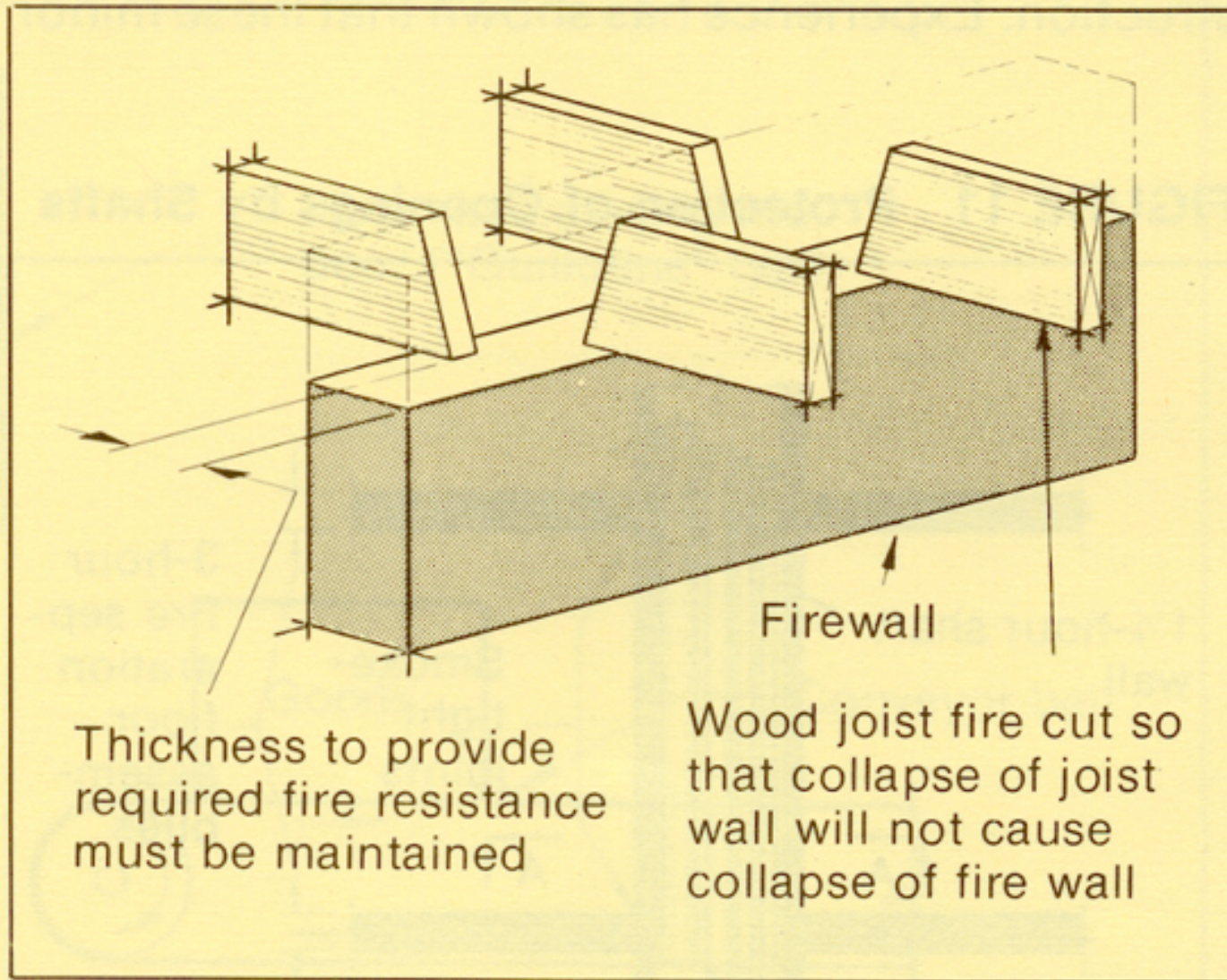




**FIGURE 3** Maintenance of Separation



**FIGURE 14 Wood Joists in Firewall**





# Fire Resistance Rating:

- is the time in hours that an assembly can withstand the passage of flame and heat when exposed to fire under standard test conditions
- is characterized by the ability of an assembly to confine a fire or continue to perform a given structural function, or both, when exposed to fire
- these ratings are established by a government or certified private testing agency after rigorous testing; often assemblies and products will be required to have a ULC Rating (Underwriters Laboratories of Canada)



## Wildfire-Resistance: Make the “RIGHT” Choices

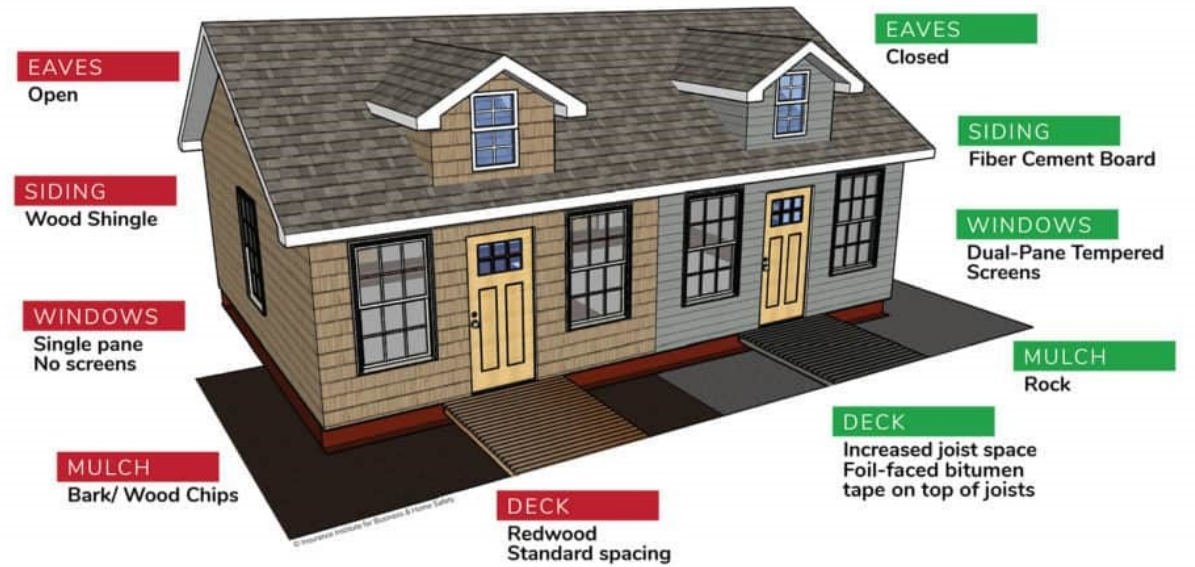


Table 1. Common Siding Materials, Estimated Installation Costs, and Relative Resistance to Several Types of Disasters (PNNL 2021)

Siding Material	Rated based on high, medium, or low resistance to wildfire					Price (\$/sq. ft. installed) <sup>1</sup>	
	Wind-Borne Debris/Hail Impact Resistance	Fire Resistance	Pest Resistance	Flooding - Sustained Moisture Resistance <sup>2</sup>	Earthquake -Seismic Resistance		
Metal	Med-High	High	High	High	High	High	\$10-25
Solid Wood (cedar shingles, clapboards, tongue and groove)	Med	Med	Low-Med	High	High	Med	\$7.5-12.5
Wood Panel (plywood, OSB, T1-11)	Low-Med	Med	Low	Low	High	Low	\$3.5-7.2
Wood-Plastic Composite	High	Low	High	Med	High	Med	\$7.5-9.5
Fiber Cement	Med	High	High	High	Med	Med	\$7-10
Plastic (vinyl siding, uPVC)	Low	Low	High	High	High	Low	\$3.5-8.5
Masonry (brick, stone)	High	High	High	High	Low	High	\$11.5-15.5
Stucco (3 coat)	Med	High	High	Low-Med	Low	Med-High	\$8-15
Exterior Insulation and Finish System (EFIS) (1-2 coat stucco)	Low	High	High	Low	Low	High	\$14

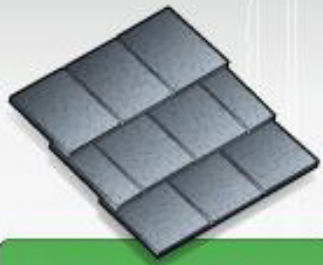
1. Price ranges derived from several sources with [sidingcost.org](https://sidingcost.org) being a starting source. Prices subject to change depending on many factors including but not limited to market conditions, material availability, and home complexity.

2. The term prolonged or sustained contact means at least 72 hours ([FEMA Tech Bull.2 2008](#)).

<https://basc.pnnl.gov/resource-guides/fire-resistant-wall-assemblies#edit-group-description>



## FIRE RESISTANT ROOFING MATERIALS:



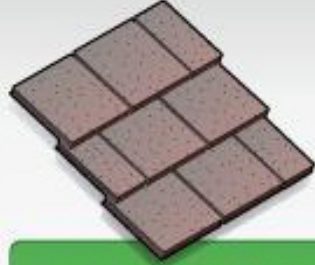
### CLAY TILE

- + Attractive  
Long lasting  
Low maintenance  
Variety of colours  
Non combustible
- Heavy weight  
Some colours may fade away  
Expensive  
Complex to install  
Walking on roof may break tiles



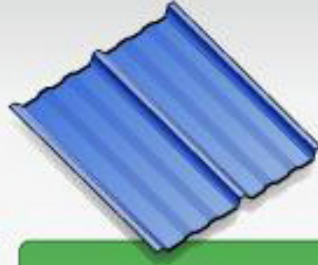
### SLATE TILE

- + Beautiful appearance  
Fireproof  
Long Lasting  
Low maintenance
- Expensive  
Heavy weight



### CONCRETE TILE (FIBER REINFORCED)

- + Durability  
Low maintenance  
Relatively light-weight  
Variety of colours and styles
- Expensive



### METAL

- + Durability  
Fire retardant  
Low maintenance  
Energy efficient  
Low weight  
Variety style and colour  
Recyclable  
Can be installed over existing roofs
- High Initial cost  
May need periodic painting  
Difficult to install

Also important to note that firefighters often need to cut through the roof to access the fire



# IGNITION TEMPERATURES OF INSULATION PRODUCTS

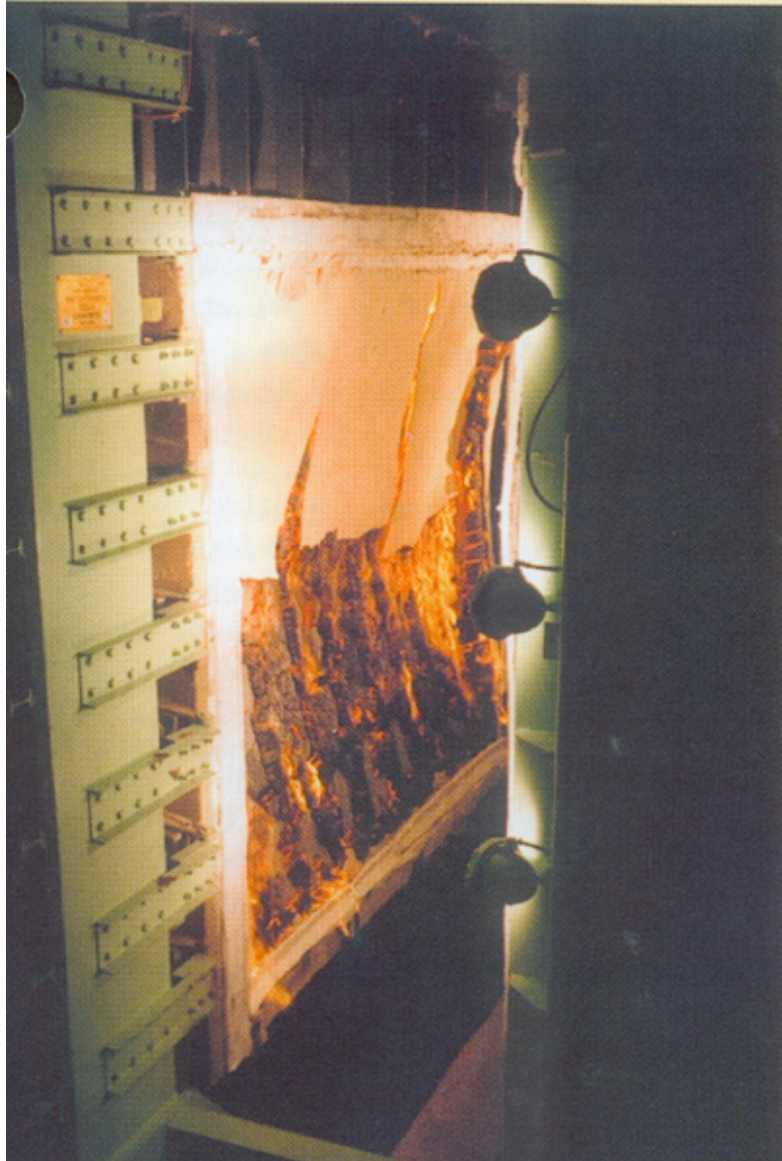
**FIBER GLASS & MINERAL WOOL ARE NONCOMBUSTIBLE**



To verify products meet applicable building code requirements, consult manufacturer's product data sheets.

1. Babraukas, V., Ignition of Wood: A Review of the State of the Art., Pp. 71-88 in Interflam 2001, Interscience Communications, Ltd., London (2001)
2. Smoldering Combustion Hazards of Thermal Insulation Materials, U.S. Department of Commerce, National Bureau of Standards (1981)
3. Thermal Barriers for the Spray Polyurethane Foam Industry, SPFA (2000)
4. PIMA Technical Bulletin #405, "Fire Resistance Properties of Polyiso Foam Plastic Insulation Used in Wall Assemblies"



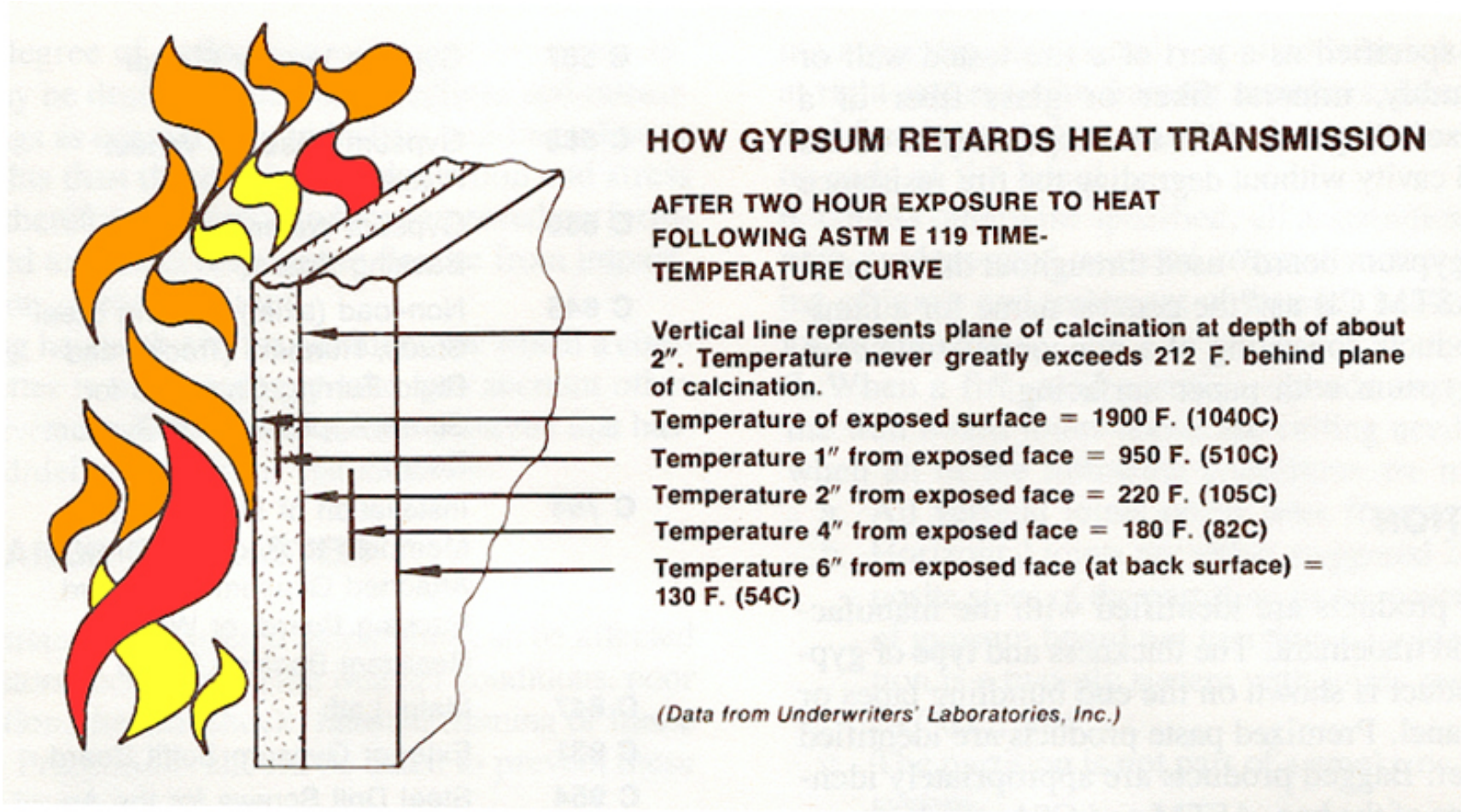


The fire resistance rating of a structural assembly is determined by subjecting the assembly to a standard fire, ranging from 1000°F at 5 minutes to 1700°F at one hour. The assembly, if designed to be loadbearing, must support the full design load for the duration of the fire test without allowing any flames to pass through.

Fire testing of loadbearing and non-loadbearing wood stud and sheet metal stud wall assemblies protected with gypsum wallboard show that fire rated wood stud wall assemblies prevent fire spread through the wall for as long as, if not longer than, identical walls built with sheet metal studs. <sup>23, 24, 25</sup>

**Figure 4** Wood Stud Wall Assembly After 1 hour Test.





# Basics of Fire-Rated Drywall

**Type X**

**Type C**

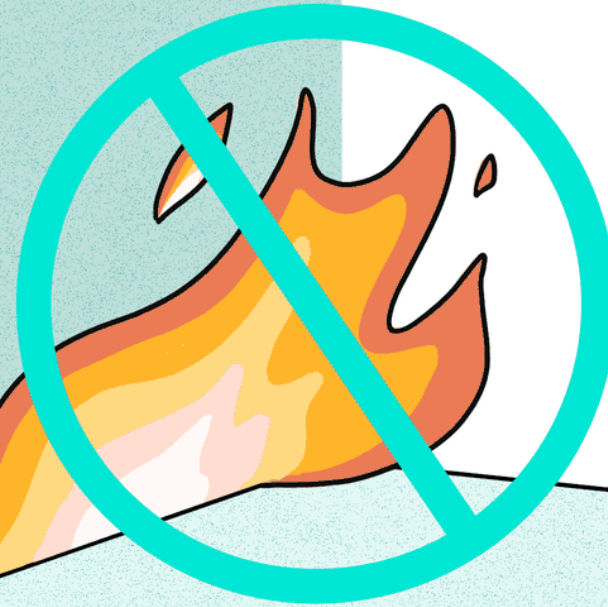
TYPE C HAS MORE ADDITIVES TO GYPSUM CORE THAT MAKE IT SLIGHTLY MORE FIRE-RESISTANT

**BOTH:**

- 5/8 INCHES THICK
- EMBEDDED WITH GLASS FIBERS
- 60-MINUTE WALL SYSTEM RATINGS\* (BASED ON DRYWALL TYPE, PLUS SPECIFIC ASSEMBLY SYSTEMS)

**NEITHER:**

ARE 100% FIREPROOF







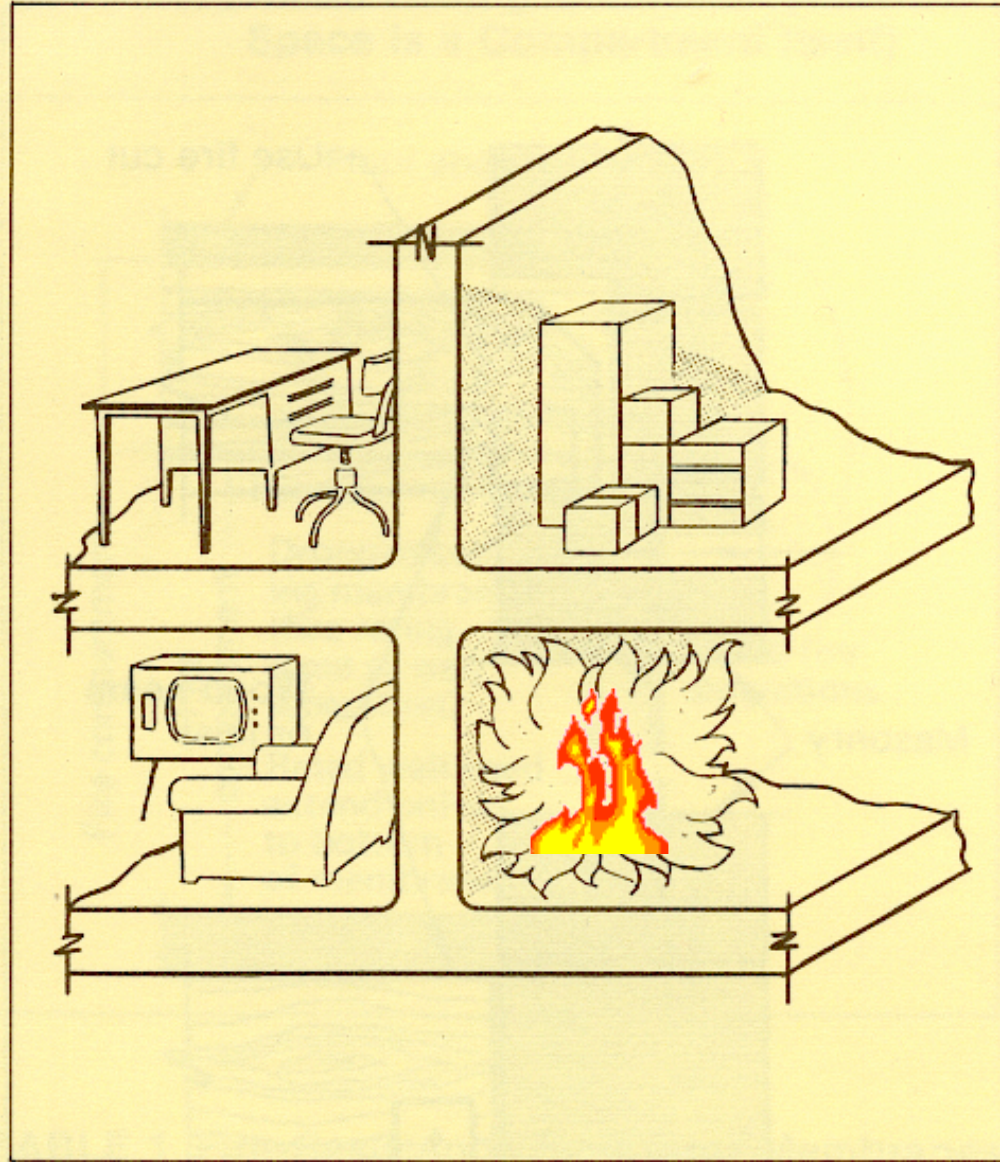
The choice of material for fire separations does not only depend on what is “permitted” but also, what will stand up to the pressure of the fire hose.



# Fire Compartment:

- an enclosed space within a building that is separated from other parts of the building by surrounding continuous construction built as a rated fire separation
- between row houses or apartments, a one hour fire separation is required
- openings are allowed in the fire separation, but are limited in size and must be able to be closed

**FIGURE 1 Fire Compartments**



Major occupancy — Hotel (Group C)

Subsidiary occupancies:

Lobby (Group A-2)

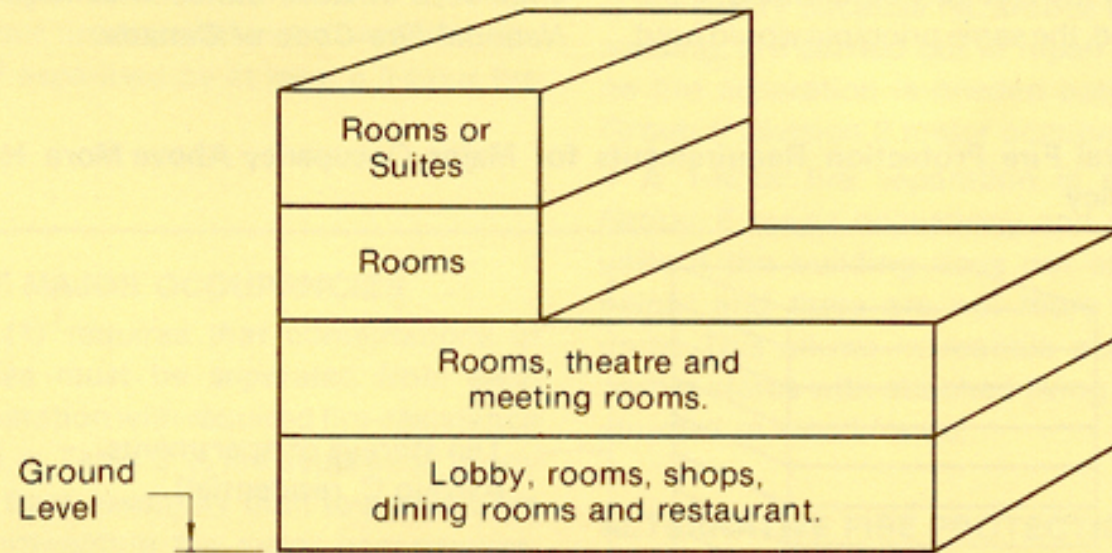
Shops (Group E)

Restaurant (Group A-2)

Dining rooms (Group A-2)

Theatre (Group A-1)

Meeting rooms (Group A-2)



Structural fire protection requirements of the most restrictive major occupancy must be applied to the entire building (Subsection 3.2.2.) Other occupancies are not counted as major occupancies for purposes of determining structural fire protection when the aggregate of a particular group or division comprises 10% or less of the floor area of the storey in which they occur. (Group F, Division 1 and 2 occupancies excepted).

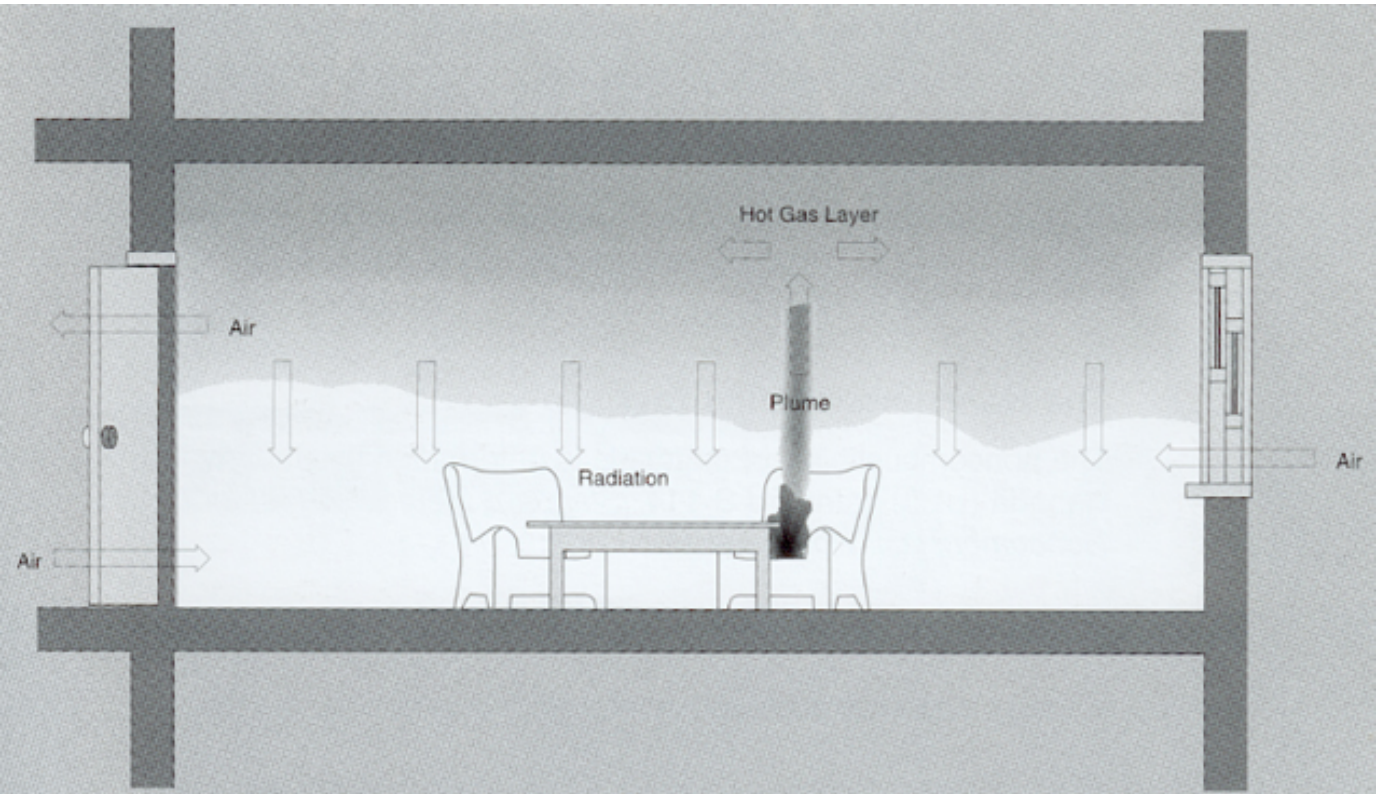


**TABLE 3 Grade of Fire Separation Required Between Major Occupancies (Hours)**

Grade of Fire Separation, hr	Group A Division 1		Assembly		FIRE SEPARATIONS BETWEEN MAJOR OCCUPANCIES		Institutional		Residential		Business and Personal Services		Merchandise		Industrial	
	1	Group A Division 2														
	1	1	Group A Division 3		Group B Division 1		Group C		Group D		Group E		Group F Division 1			
	1	1	1	Group A Division 4												
	2	2	2	2	Group B Division 2		Group F Division 2		Group F Division 3							
	2	2	2	2	2											
	1	1	1	1	2	2	Group F Division 2		Group F Division 3							
	1	1	1	1	2	2	1	Group F Division 2		Group F Division 3						
	2	2	2	2	2	2	2 <sup>(3)</sup>	NR	Group F Division 2		Group F Division 3					
	NP	NP	NP	NP	NP	NP	NP	3	3	Group F Division 2		Group F Division 3				
	2	2	2	2	2	2	2 <sup>(4)</sup>	NR <sup>(2)</sup>	NR <sup>(2)</sup>	2	Group F Division 2		Group F Division 3			
	1 <sup>(1)</sup>	1 <sup>(1)</sup>	1 <sup>(1)</sup>	1 <sup>(1)</sup>	2	2	1 <sup>(1)</sup>	NR <sup>(1)</sup>	NR <sup>(1)</sup>	2	NR <sup>(1)</sup>	Group F Division 2		Group F Division 3		

- Notes: (1) A 1½-hour fire separation is required when the Group F Division 3 occupancy is a storage garage. (See Sentence 3.3.7.6.(11).)
- (2) A 2-hour fire separation is required when the Group F Division 2 occupancy is a repair garage. (See Sentence 3.3.7.6.(10).)
- (3) If the building containing a Group E major occupancy is not over three storeys in height and the Group C major occupancy does not contain more than two dwelling units, only a 1-hour fire separation is required.
- (4) Not more than 1 dwelling unit permitted.
- NP — Not permitted; prohibited occupancy combination.
- NR — Not required.





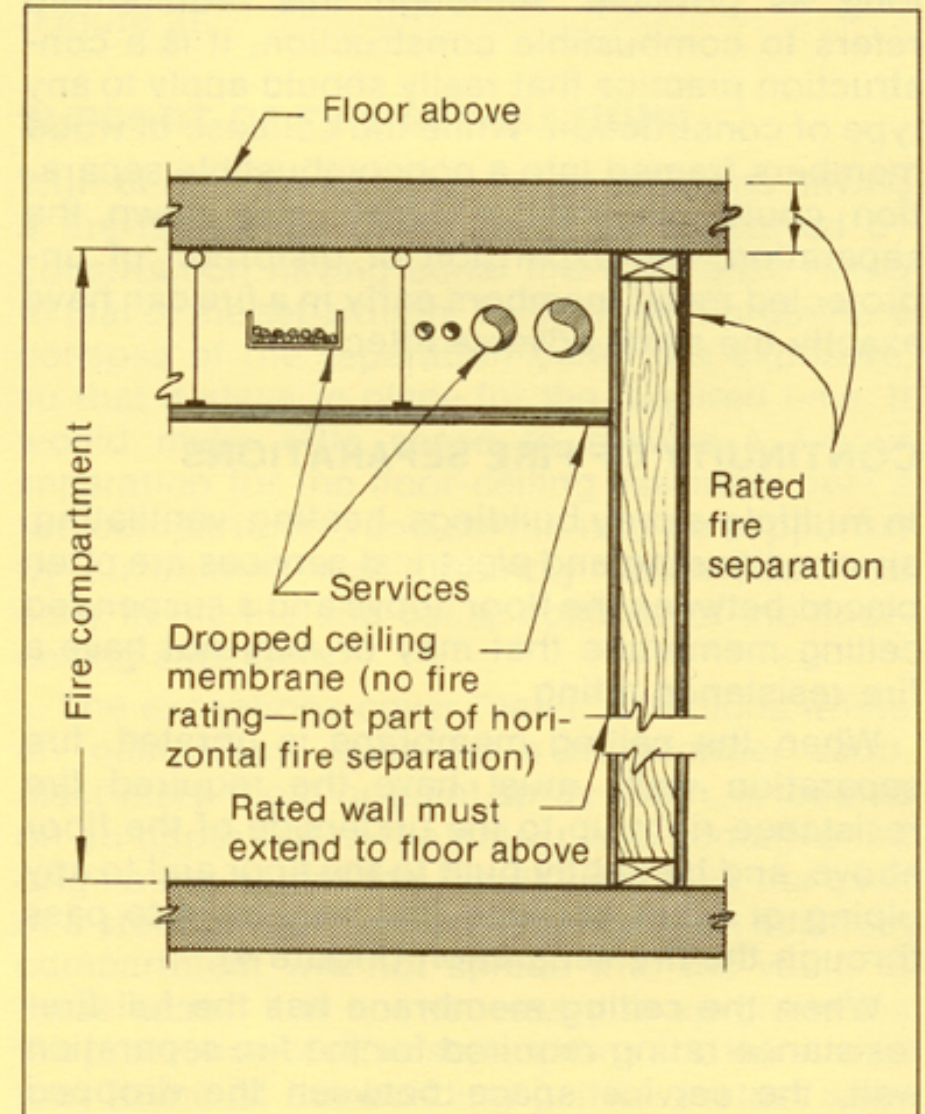
### Fire Growth in a Room

To understand the measures outlined in this Chapter, it is useful to describe what happens when a fire occurs in a room. When an object is burning in an enclosed area, smoke rises to form a hot gas layer below the ceiling. These hot gases heat the ceiling and upper portion of the walls and thermal radiation from the hot layer, ceiling and walls begins to heat all the objects in the room. Given sufficient oxygen, this heating process can progress until all other combustible objects in the room reach their ignition temperature more or less simultaneously. At this point, every combustible object in the room will burst into flames, a state referred to as "flashover." Flashover occurs when the temperature of the hot upper layer of air in the room reaches 500 to 600°C (needless to say, any occupants of the room would have perished long before this point).

# Fire Stopping:

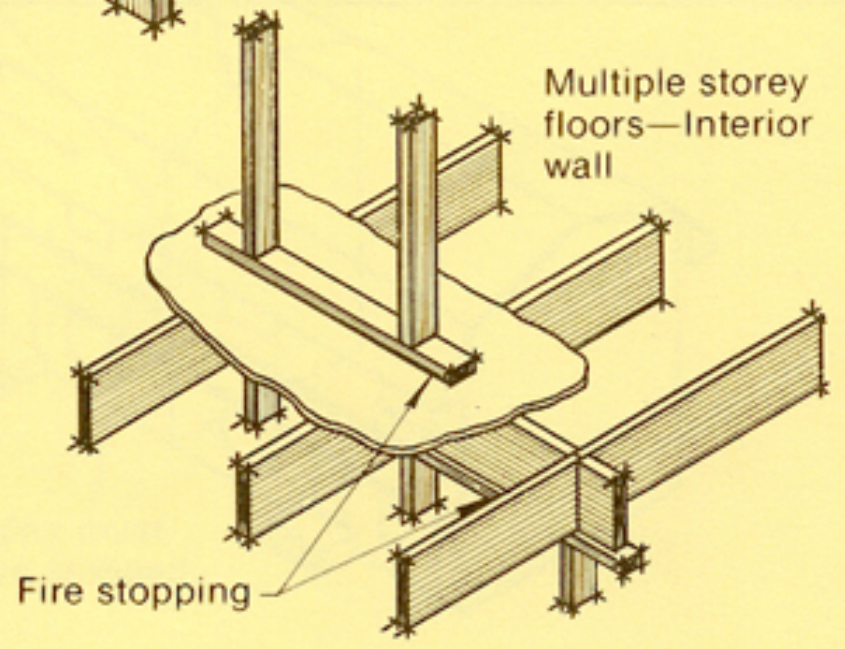
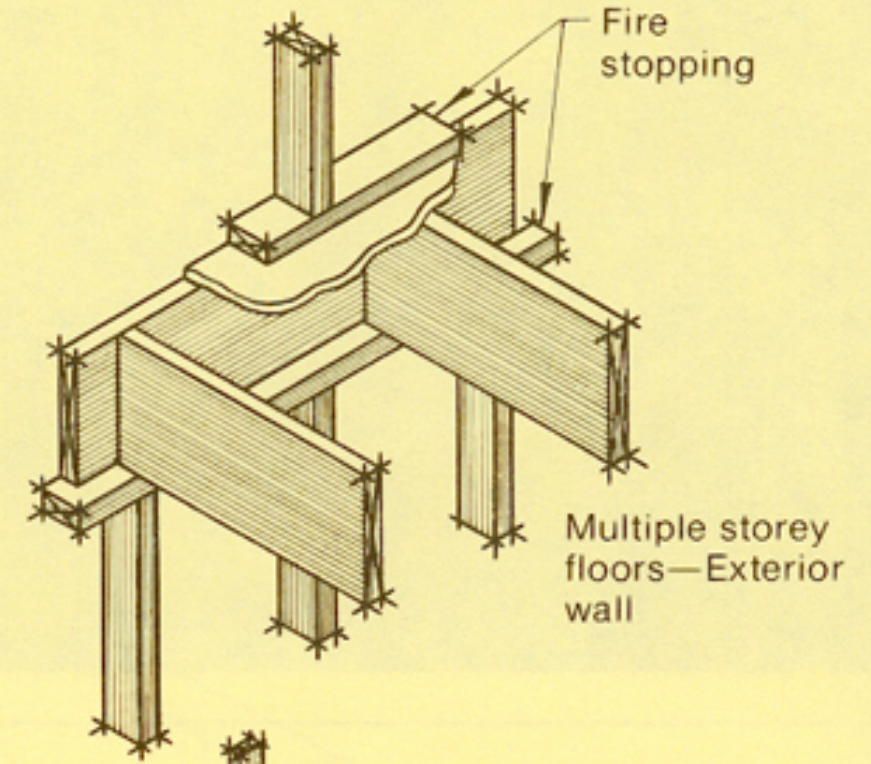
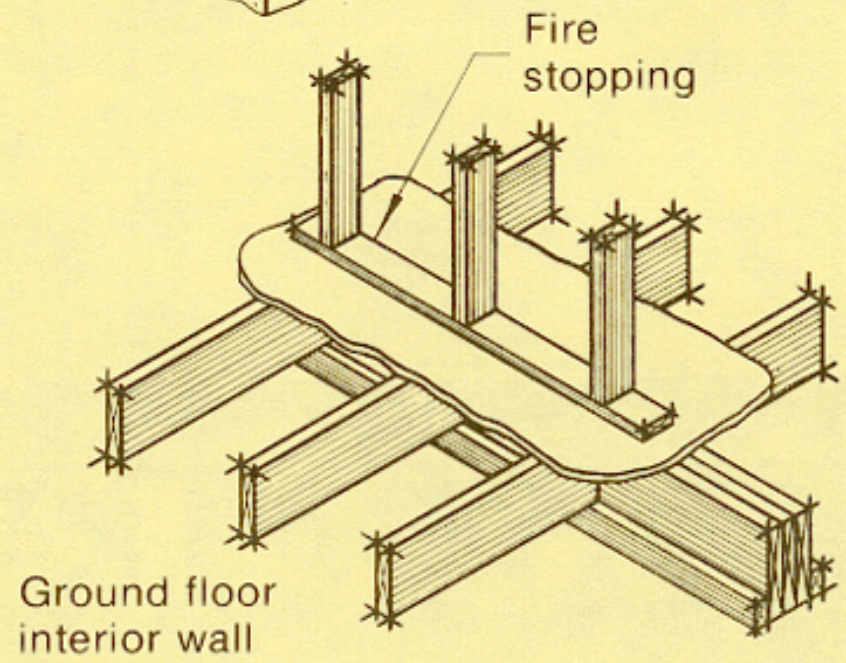
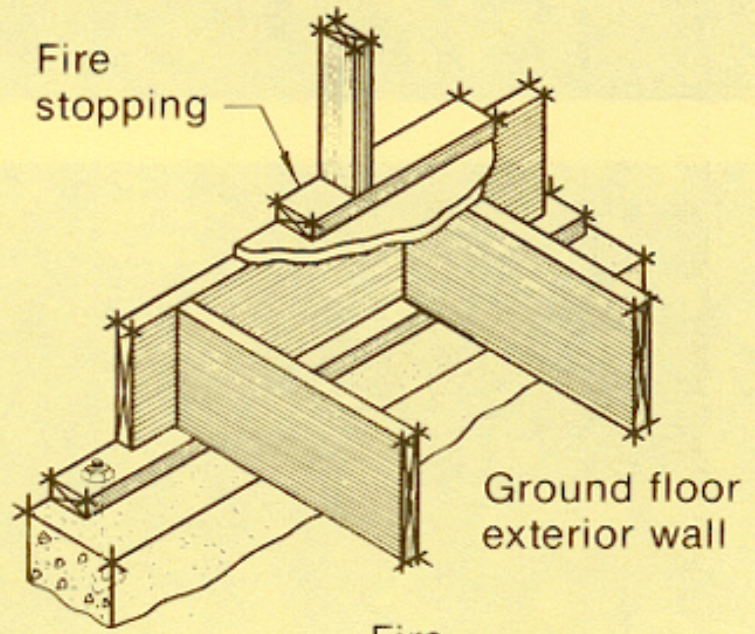
- the blocking of concealed spaces in walls, ceilings and floors to slow down the undetectable spread of fire throughout the building
- prevents these chaseways from acting as chimneys

**FIGURE 4** Rated Wall Construction with Unrated Ceiling Membrane (Compartment Extends to Bottom of Floor Above)



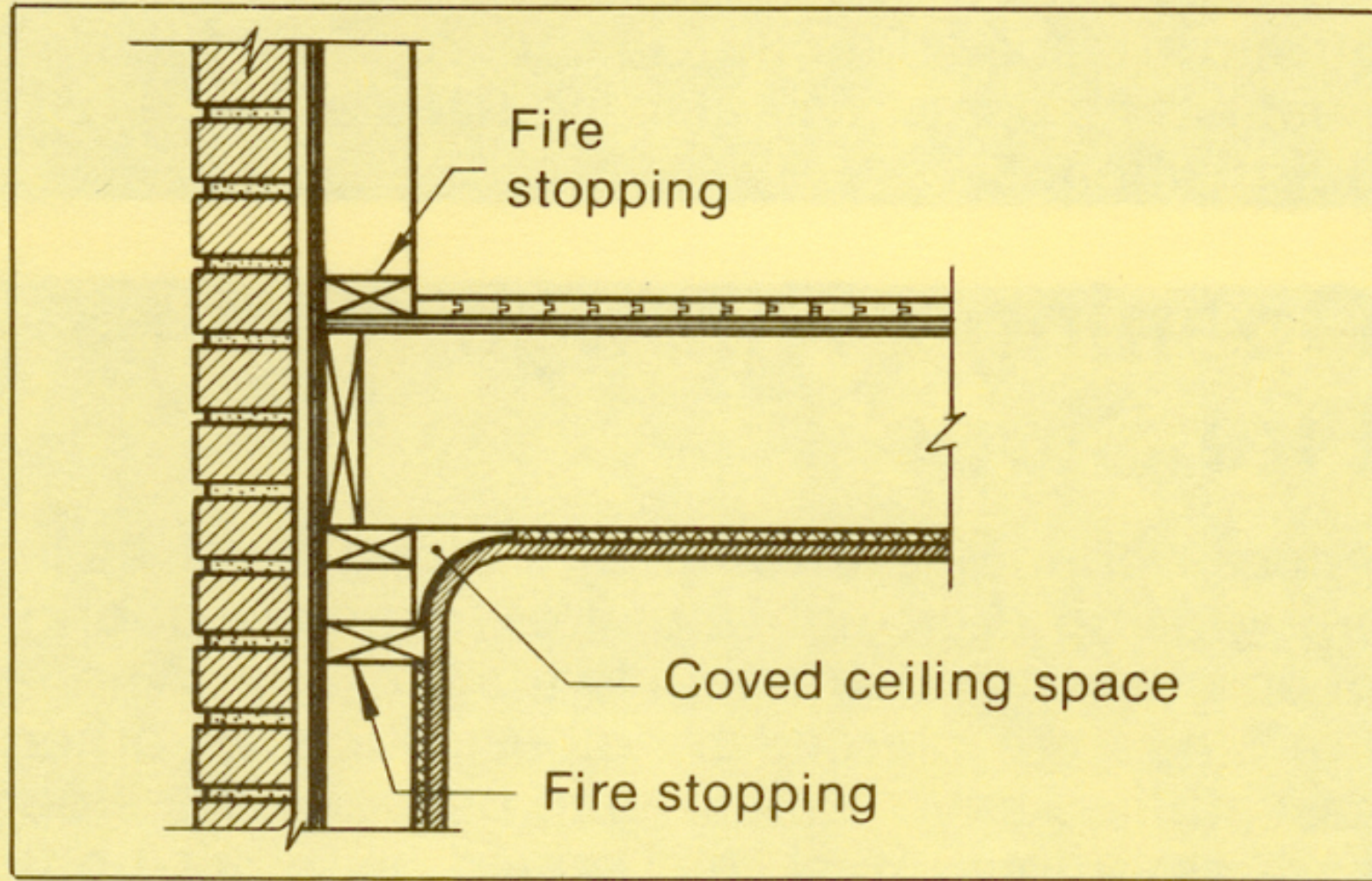


**FIGURE 1 Wood Fire Stopping**

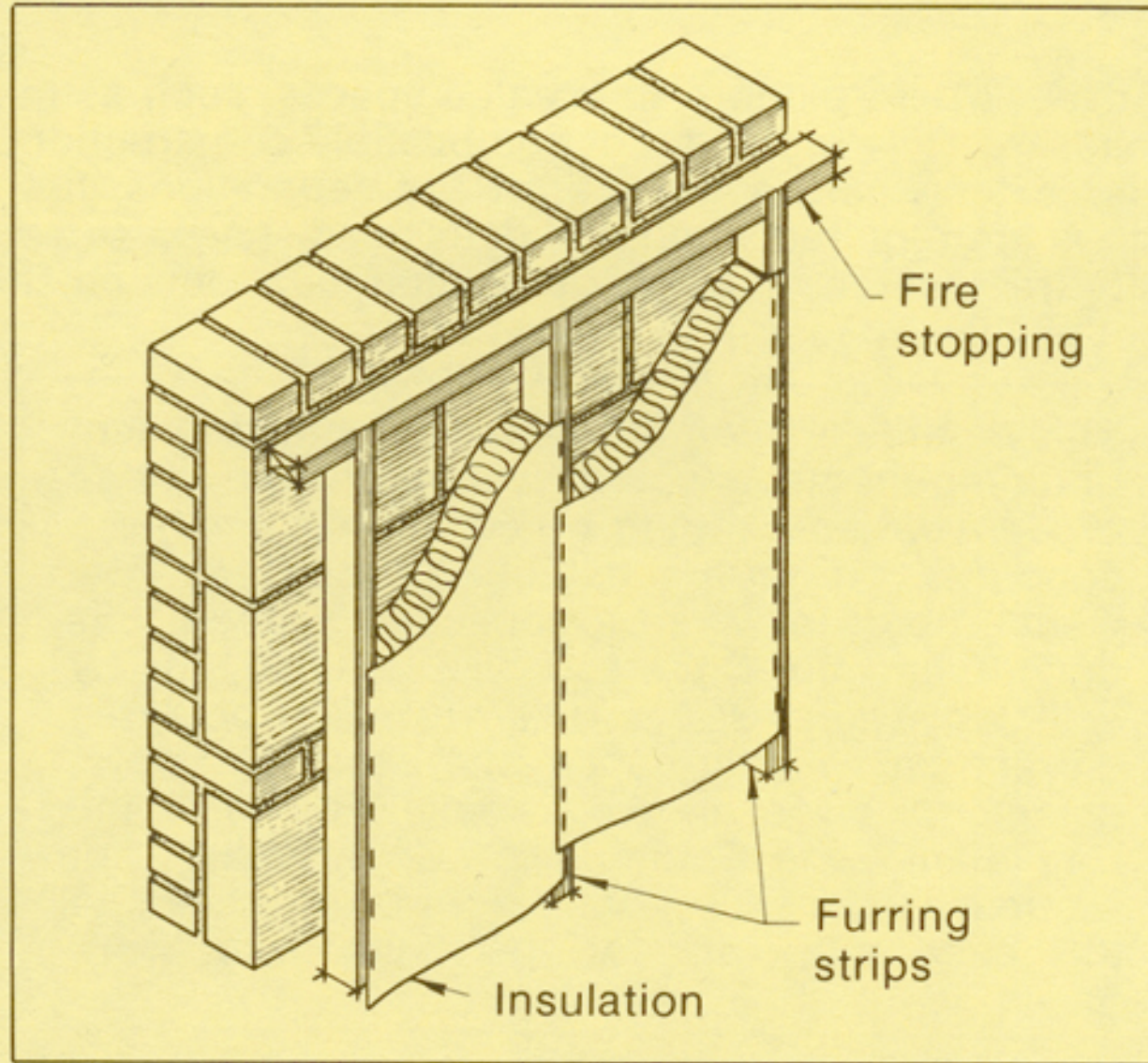




**FIGURE 2 Coved Ceiling Fire Stopping**



**FIGURE 3 Furring as Fire Stopping**





**FIGURE 4 Stair Fire Stopping**

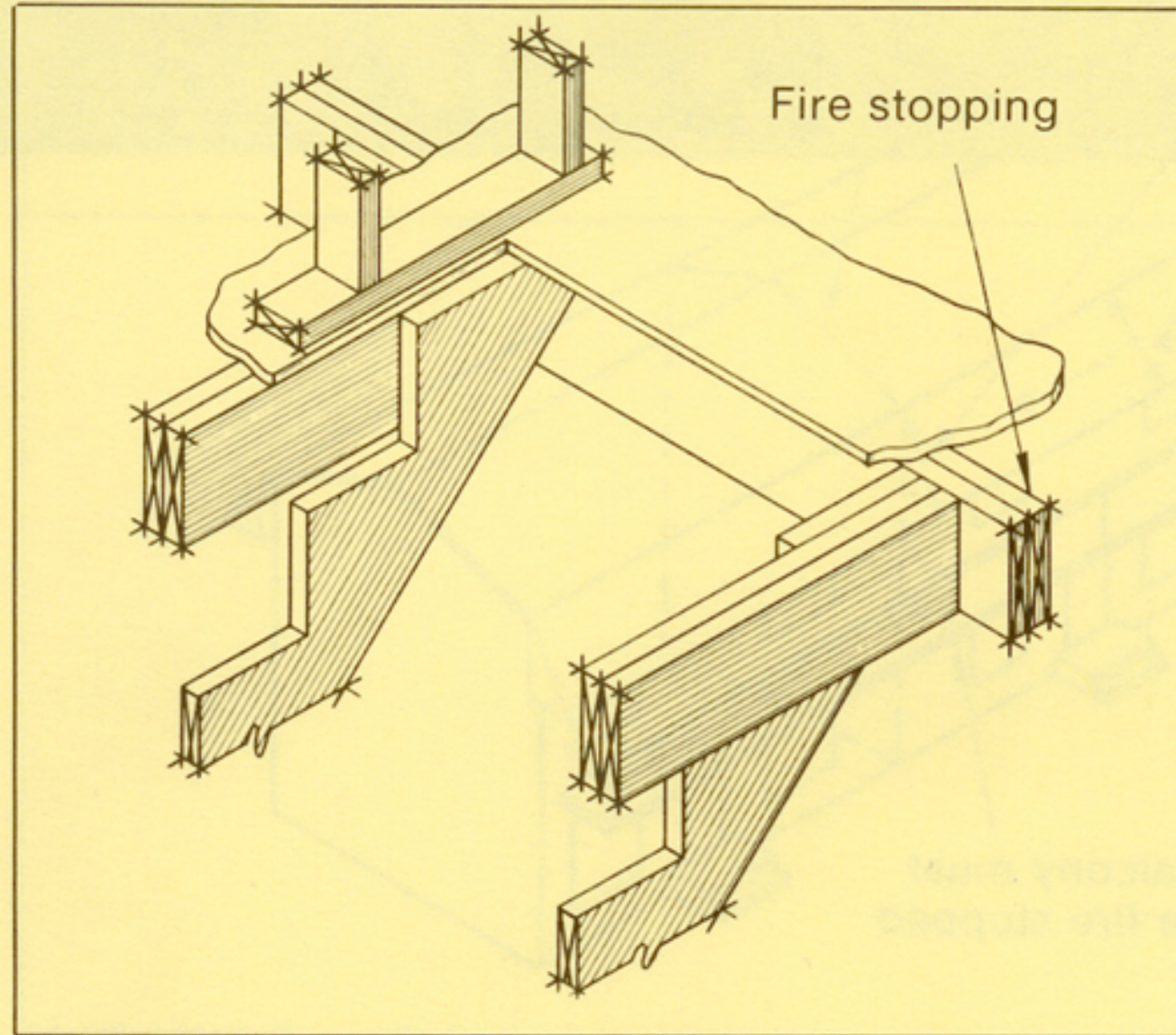
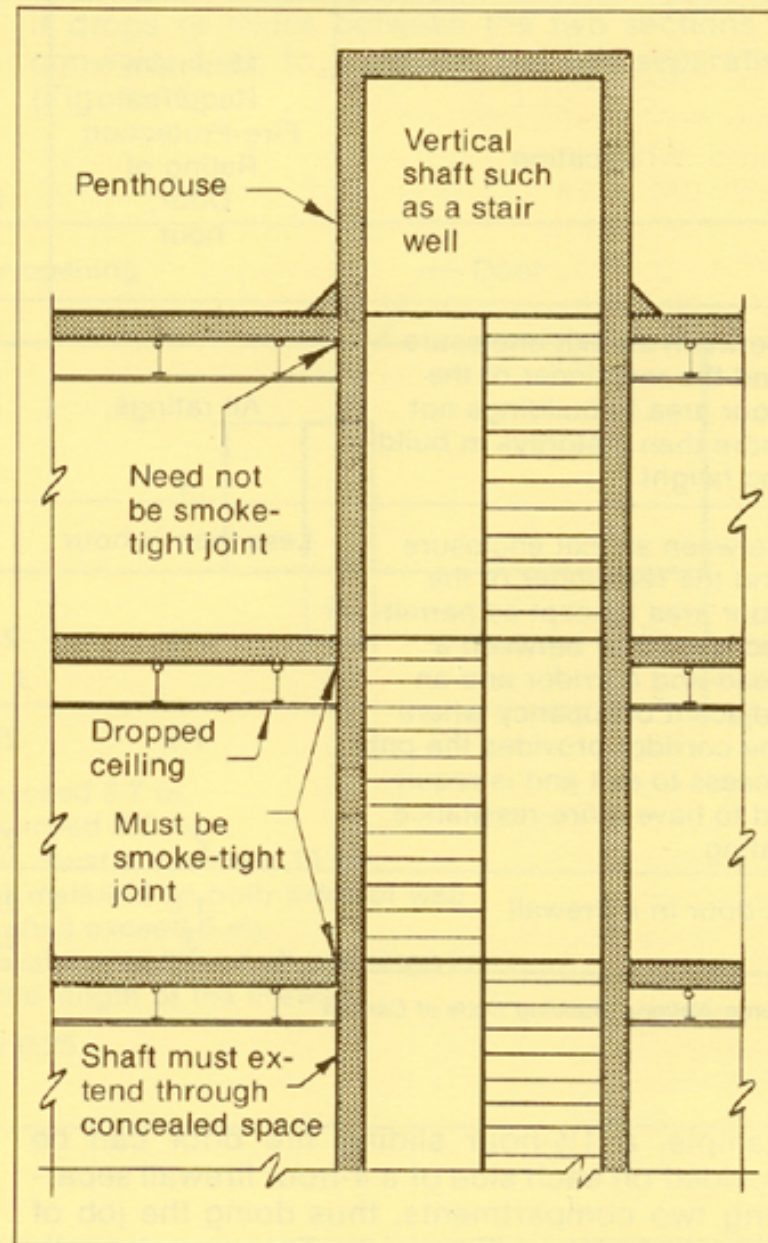
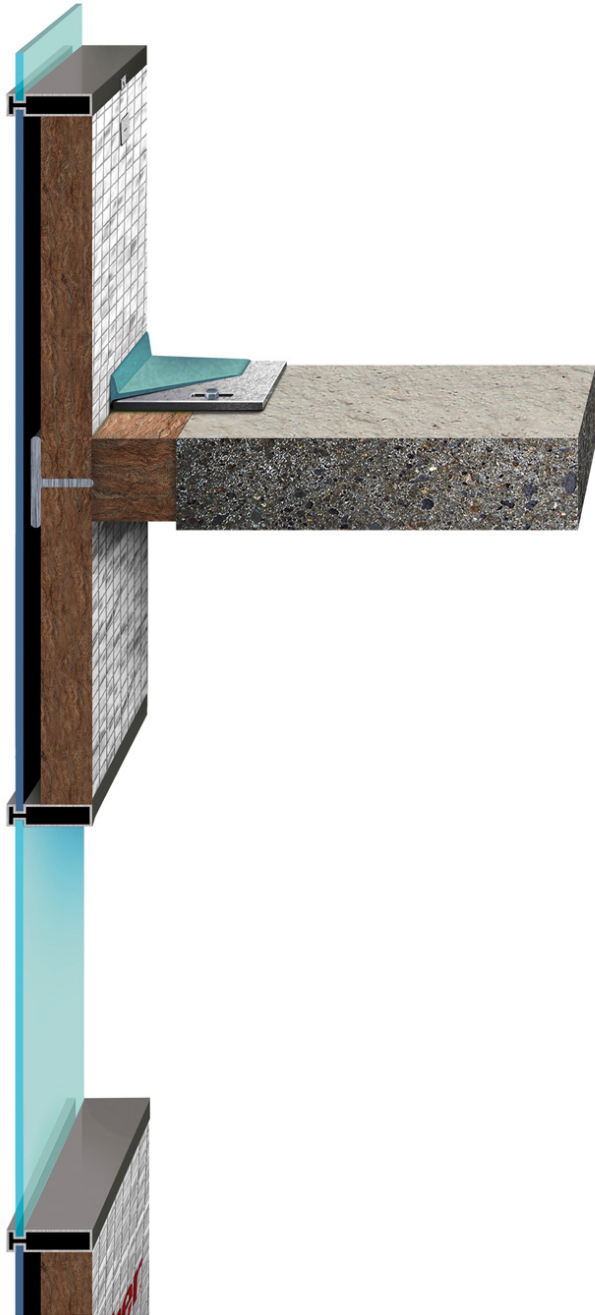


FIGURE 7 Vertical Shafts







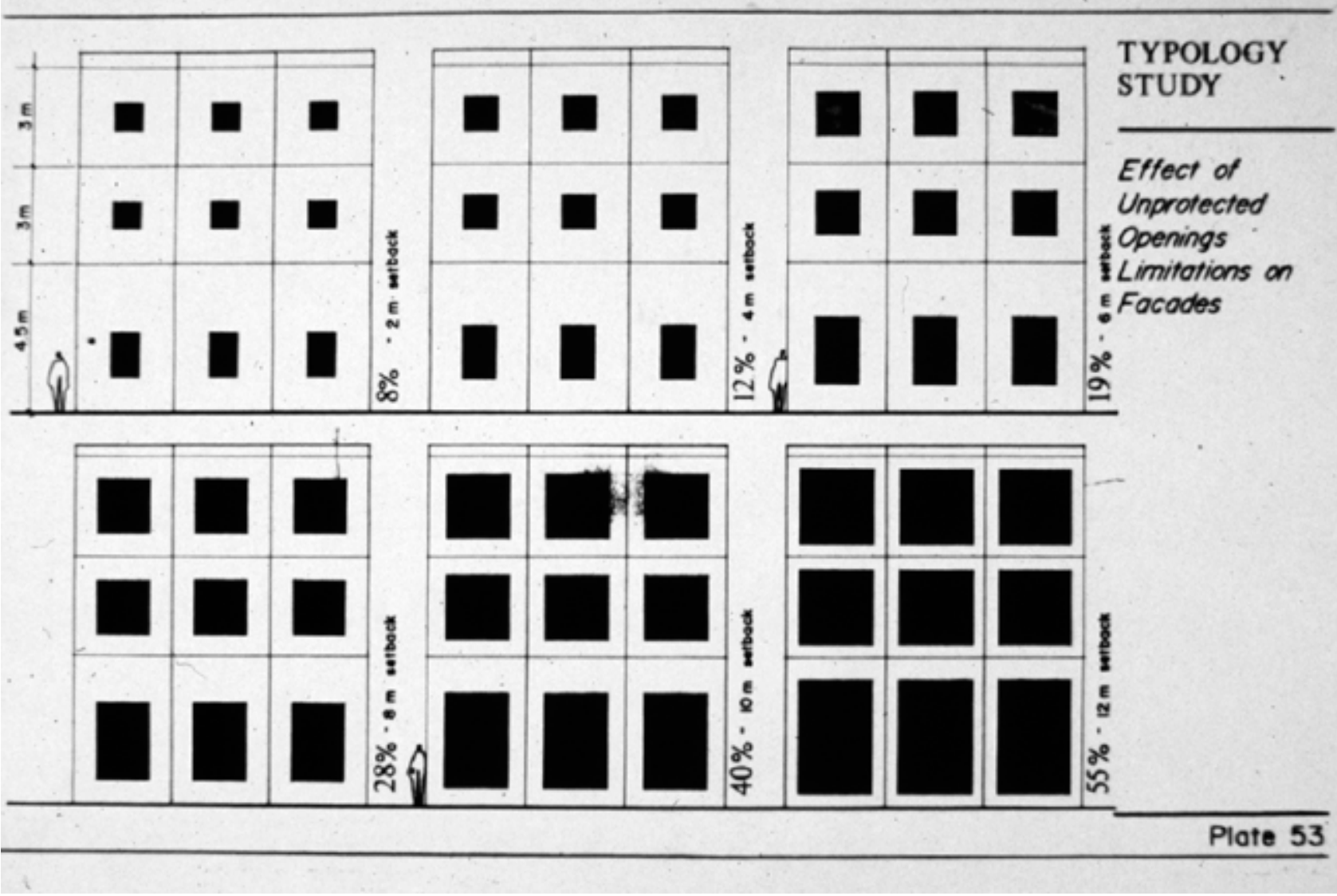
Curtain walls require special fire stopping between the slab edge and the curtain wall system

# Unprotected Openings:

- any portion of an exterior building face that does not meet the fire resistance rating required for the building face (ie. windows, doors, vent grilles)
- steel window frames, wired glass and glass block allow for a doubling of the OBC maximums
- sprinklering allows for a doubling of areas







# Sizing Unprotected Openings:

- limits are based on distance from property lines, as a % of the building face area
- ie. for residential (50 s.m. building face):
  - less than 1.2m setback allows 0%
  - 1.2m setback allows 7%
  - 1.5m setback allows 8%
  - 2.0m setback allows for 10%
  - 4.0m setback allows for 28%





**TABLE 1 Minimum Construction Requirements for Exposing Building Face**

Occupancy Classification of Fire Compartment	Percentage of Unprotected Openings Permitted	Minimum Required Fire-Resistance Rating for Exposing Building Face	Minimum Construction Requirements	Minimum Cladding Requirements
Group A, B, C, D and Group F, Division 3	0 — 10%	1-hour	Noncombustible construction	Noncombustible
	Greater than 10% up to 25%	1-hour	Can be combustible construction if building allowed to be of combustible construction	
	Greater than 25% up to 99%	¾-hour		Can be combustible if building allowed to be of combustible construction
	100%	None required		
Group E, Group F, Division 1 and Group F, Division 2	0 — 10%	2-hour	Noncombustible construction	Noncombustible
	Greater than 10% up to 25%	2-hour	Can be combustible construction if building allowed to be of combustible construction	
	Greater than 25% up to 99%	1-hour		Can be combustible if building allowed to be of combustible construction
	100%	None required		

# Limiting Distance:

- refers to the distance between an exposing building face and the property line or to an imaginary line between two buildings on the same property.
- if the two buildings are the same (area of face and glass) the line will be midway; if they are different, the distance will be proportional







## Exposing Building Face:

- is the area of an exterior wall of a building, between the ground level and the ceiling of the top storey, facing in one direction
- where a building is divided into “fire compartments”, the exterior wall of each fire compartment becomes an exposing building face and is calculated separately



# High Rise Fires:



High rise fires require a different attitude towards designing for structural safety to allow for evacuation. Smoke kills more than fire.



# Standard Methods for High Rise Buildings

- Build a reinforced concrete structure
- Put a fireproof layer on a steel structure
  - Spray on fireproofing
  - Concrete over top of steel
  - Hollow steel filled with concrete
  - Layers of fire resistant gypsum board
- Use a hollow steel structure that is filled with water

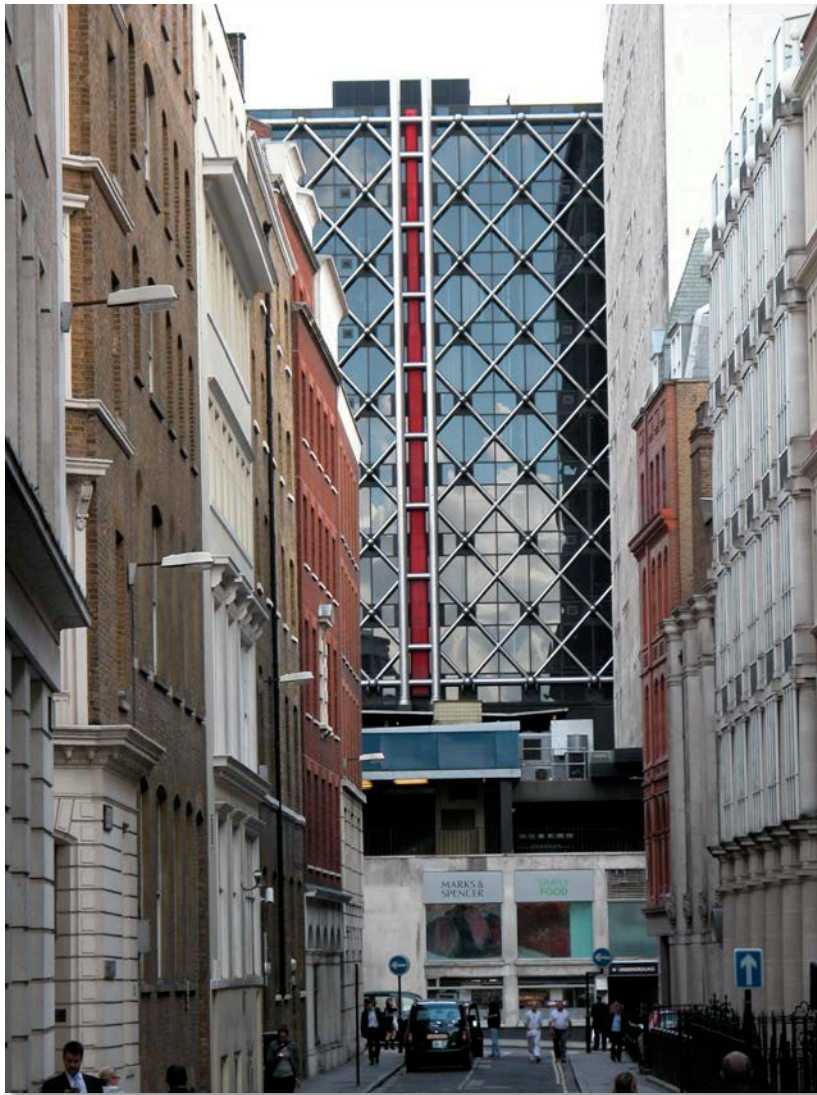




West  
Guangzhou  
Tower  
400m



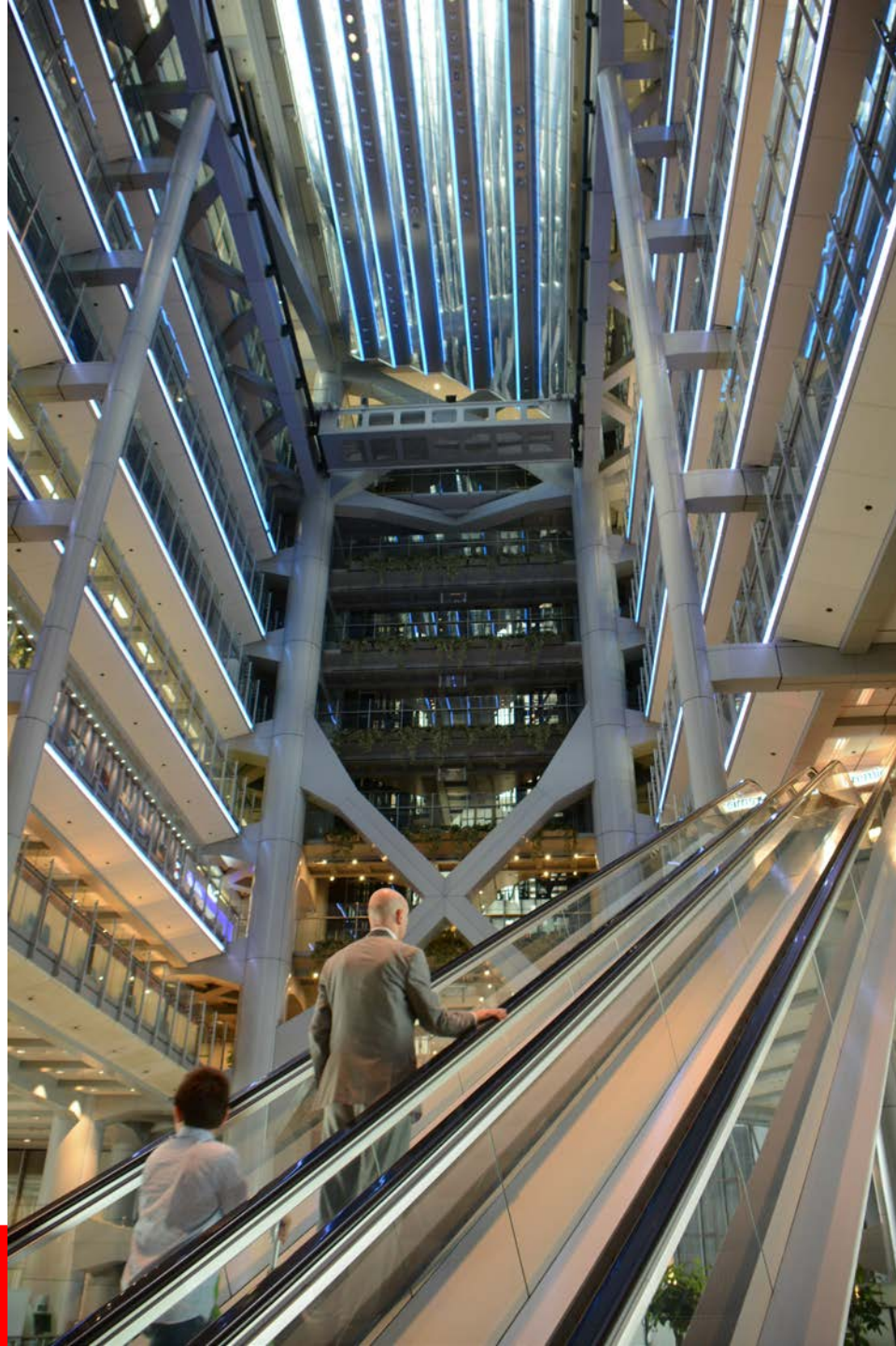
Hollow steel  
1.5m dia.  
concrete  
filled



Bush Lane House, London: stainless steel exterior tube structure filled with water







Hong Kong Bank  
Uses a cladding  
system over the  
hollow steel  
frame that  
circulates a  
cooling liquid  
in case of fire.  
System requires  
excellent  
sealing!



# Learning from Large High-Rise Fires in Sao Paulo

- During the '70s and '80s Brazil suffered several high-rise fires with grave consequences, and unfortunately the problem was only properly understood after a number of large fires such as the Andraus Building (16 dead and 375 injured), the Joelma Building (79 Dead and 345 injured), and Grande Avenida Building (17 dead, 53 injured). These resulted in significant advances in fire safety such as new legislation, required inspections, codes and standards, public education and professional development, and statistics and investigations.
- Brazil normally used reinforced concrete for their high rise structures (not steel)
- most current high rise buildings are designed to last 2 hours in a “normal fire” (fuel is office furniture) which is principally to allow the people to escape before the building would collapse



Andraus Building, Sao Paolo:  
16 dead, 375 injured







Joelma Building, Sao Paolo, 1974:  
79 dead and 345 injured

Grande Avenida, Sao Paulo: 17  
dead, 53 injured





# MGM Grande, Las Vegas:

November 21, 1980:

84 people died and 700 were injured

Up to this point, worst fire death toll in US History



## Other Fires in Las Vegas:

- Fires shown below are a roof fire at Caesars Palace and a mid rise apartment fire







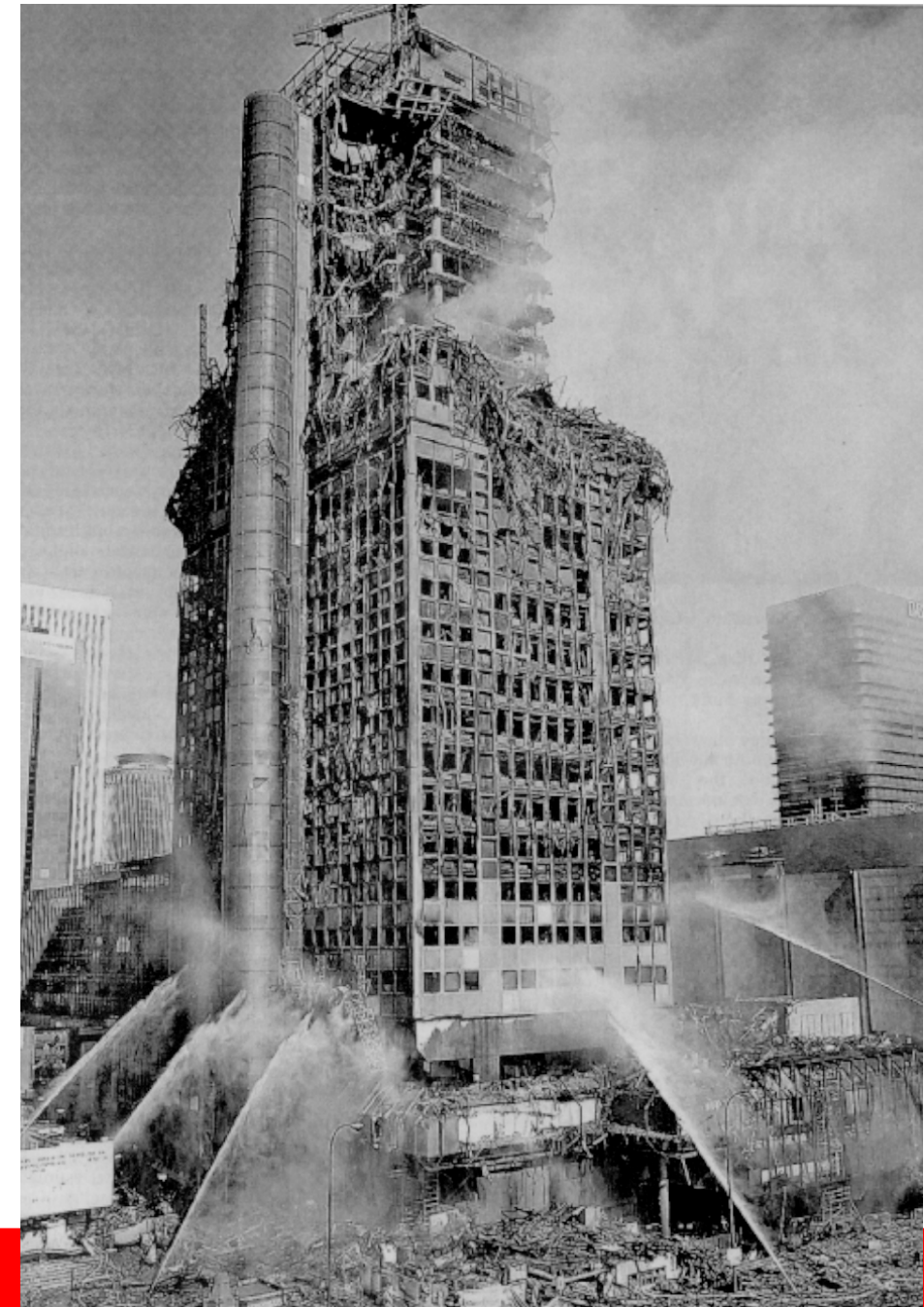
## Fire Design in High Rise Buildings: post 1970's disasters

- Structure to last no less than 2 - 3 hours
- remember that most people die from smoke inhalation, not fire
- elevators NOT to be used as they can malfunction due to electrical problems and shafts can fill with smoke
- stair wells must be fire-safe and pressurized to keep smoke OUT

# Fire Tests for High Rise Buildings:

- Fire resistive products used to protect commercial hi-rise buildings are tested to ASTM E119
- requires that the fire resistive product protects the steel from reaching a limiting temperature during the time period required by the building codes.
- For the structural frame (columns and primary beams) the time period is 3 hours and the limiting temperature is 1200 F at any measured point on the column.
- For the primary beams the limiting temperature is 1300 F at any measured point on the beam.
- Floor beams require the same limiting temperature, time period reduced to 2 hours.
- The test furnace follows a temperature curve so that the test specimen is exposed to a temperature of 1550 F at 1/2 hour, 1700 F at 1 hour 1850 F at 2 hours, 1960 F at 3 hours, and 2000 F at 4 hours.

Building height means that normal fire hoses and ladders cannot reach the fire.





## Tests for Hydrocarbon Fires:

- fire resistive products used to protect refineries, petrochemical plants, etc, against hydrocarbon fires are tested to UL 1709.
- This standard requires that the test furnace reaches 2000 F in 5 minutes. Under this test then, the fire resistive product with a 3 hour column rating has been exposed to a temperature of 2000 F for 2 hours 55 minutes.
- You can see that the severity and speed of a hydrocarbon fire is much greater than a standard fire. The WTC towers were exposed to the severity of a hydrocarbon fire.

# Concrete vs. Steel Structure??

- Sao Paulo Brazil has the unenviable record of having 3 of the most severe fires in the western hemisphere.
- These were all reinforced concrete buildings.
- 1/3<sup>rd</sup> of the floor area of the 21 story CESP 2 building suffered a total collapse from the 21<sup>st</sup> floor to the ground in 1987.
- The Andraus Building in 1972 and the Joelma Building in 1974, suffered extensive structural damage.
- The post tensioned concrete roof of the Falabela department store in the Plaza Vesuvias Mall in Santiago Chile collapsed onto the 2<sup>nd</sup> floor.
- All of these fires were of normal combustibles i.e., furniture, carpets, paper, etc, that are found in any office building, and none of these buildings experienced the tremendous impact or the added massive weight of a jet plane and passengers as the WTC did.
- News videos of the Andraus and Joelma fires show massive portions of the exterior concrete walls literally exploding apart during the fire.

## Normal vs. Hydrocarbon Fires:

- The WTC was exposed to a jet fuel fire. Jet fuel is not a normal combustible. It is a "hydrocarbon", a source of much higher temperatures that will negatively affect both steel and concrete much faster than normal combustibles would
- concrete exposed to the temperatures of a hydrocarbon fire will cause the moisture in the concrete to turn into steam so rapidly that the concrete will literally and explosively break apart
- when concrete is exposed to the temperature of a normal fire the concrete can flake apart under intense heat exposing the steel (it is protecting). Under a normal fire, moisture in the concrete has a better chance of coming out of the concrete without explosively spalling
- Under a hydrocarbon fire the moisture in the concrete is heated so rapidly that it immediately turns to steam and this literally causes the concrete to explode apart. Once this happens not only is the reinforcing steel exposed, but the concrete that holds the steel rigidly in place is gone as is its stability and load carrying capacity



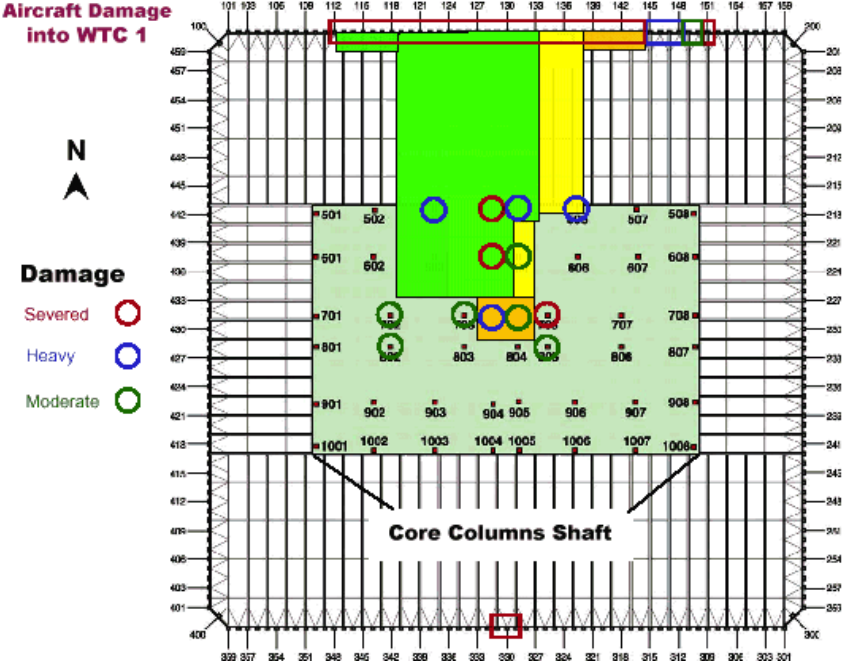
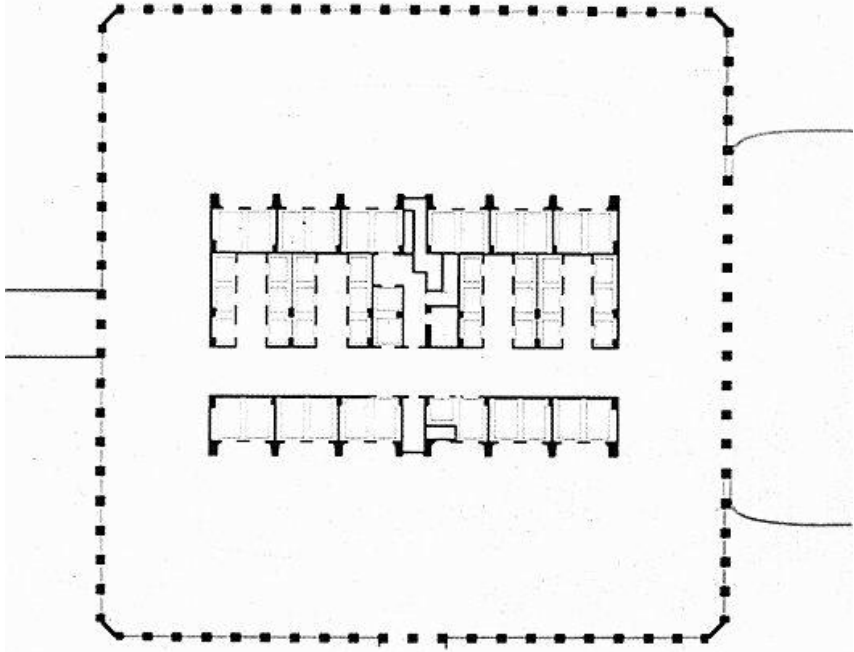
# WTC Collapse:

- “Each World Trade Center absorbed the impact of a jet with a shudder as they were designed to do, and stood.
- Inside, though, 2000-degree infernos started burning, fed by thousands of gallons of Jet Fuel” .
- “The south tower collapsed 56 minutes after impact. The north tower lasted an hour and 40 minutes” .
- The collapse was due in part by the fire, but largely because the impact of the jet took out a significant number of supporting columns
- The majority of WTC occupant deaths were the result of the destruction of the fire stairs below the top floors, at the point of impact. Most were filled with rubble, cutting off evacuation access.



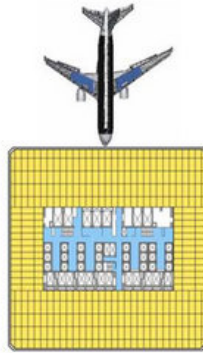
# WTC Structure:

- The plan arrangement of the WTC is typical of a tubular structure, columns spaced at 39" on center. Core was made of steel. Spray on fireproofing. Fire resistant gypsum board to protect the stairwells.



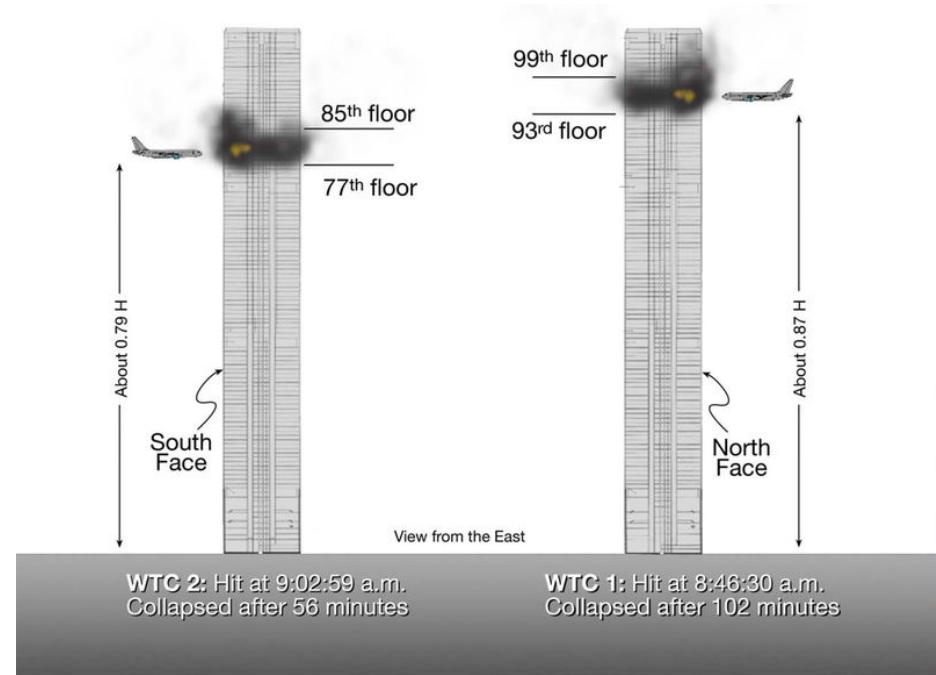
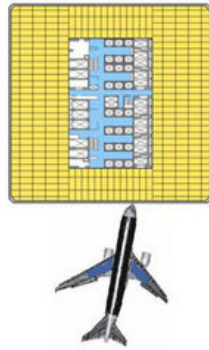
**Point of impact:**  
Close to the center  
and nearly normal  
to the building

WTC 1



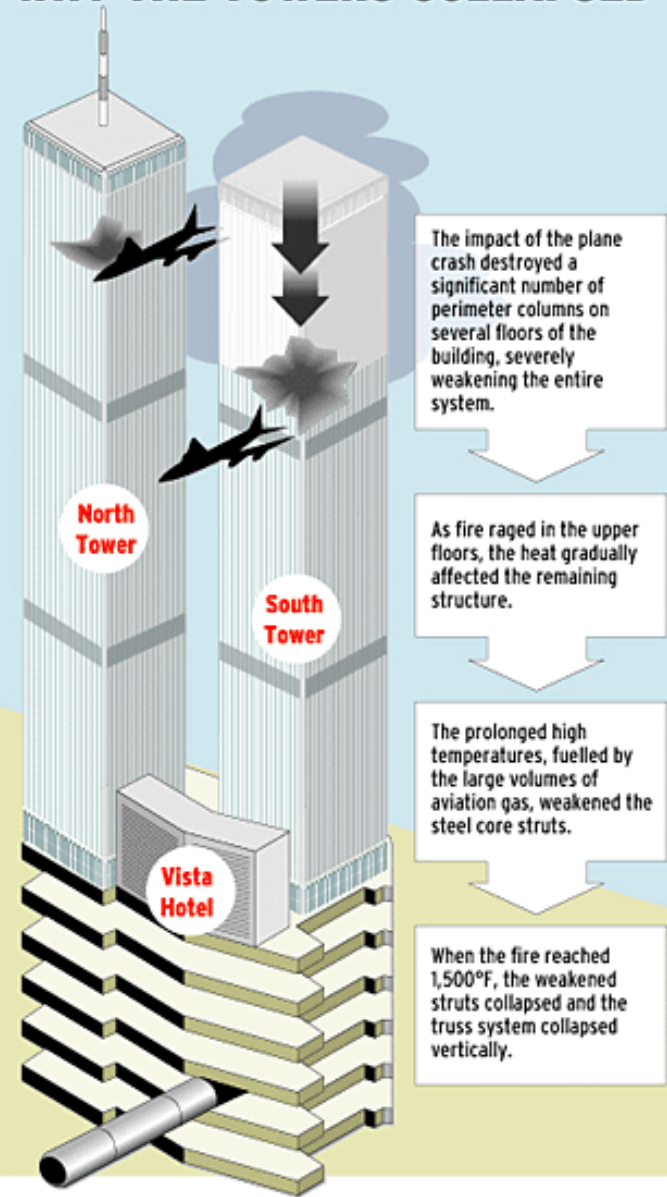
**Point of impact:**  
Close to the corner  
and with an angle

WTC 2

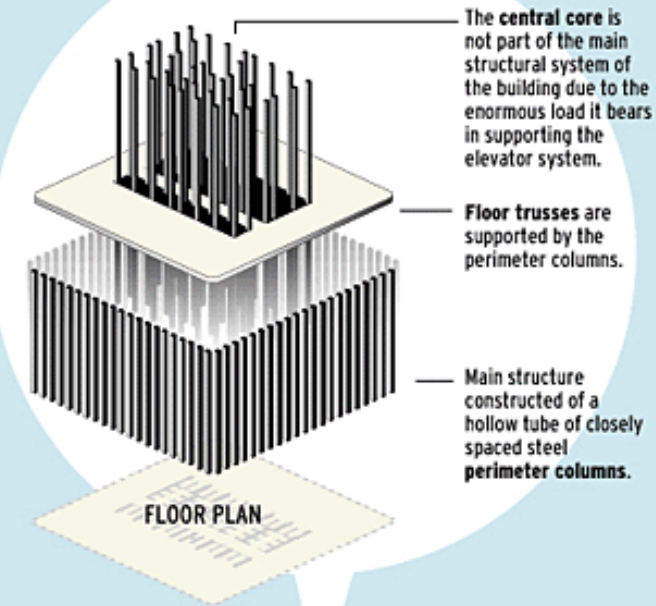




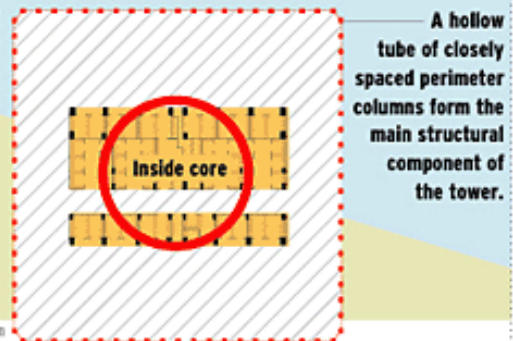
# WHY THE TOWERS COLLAPSED

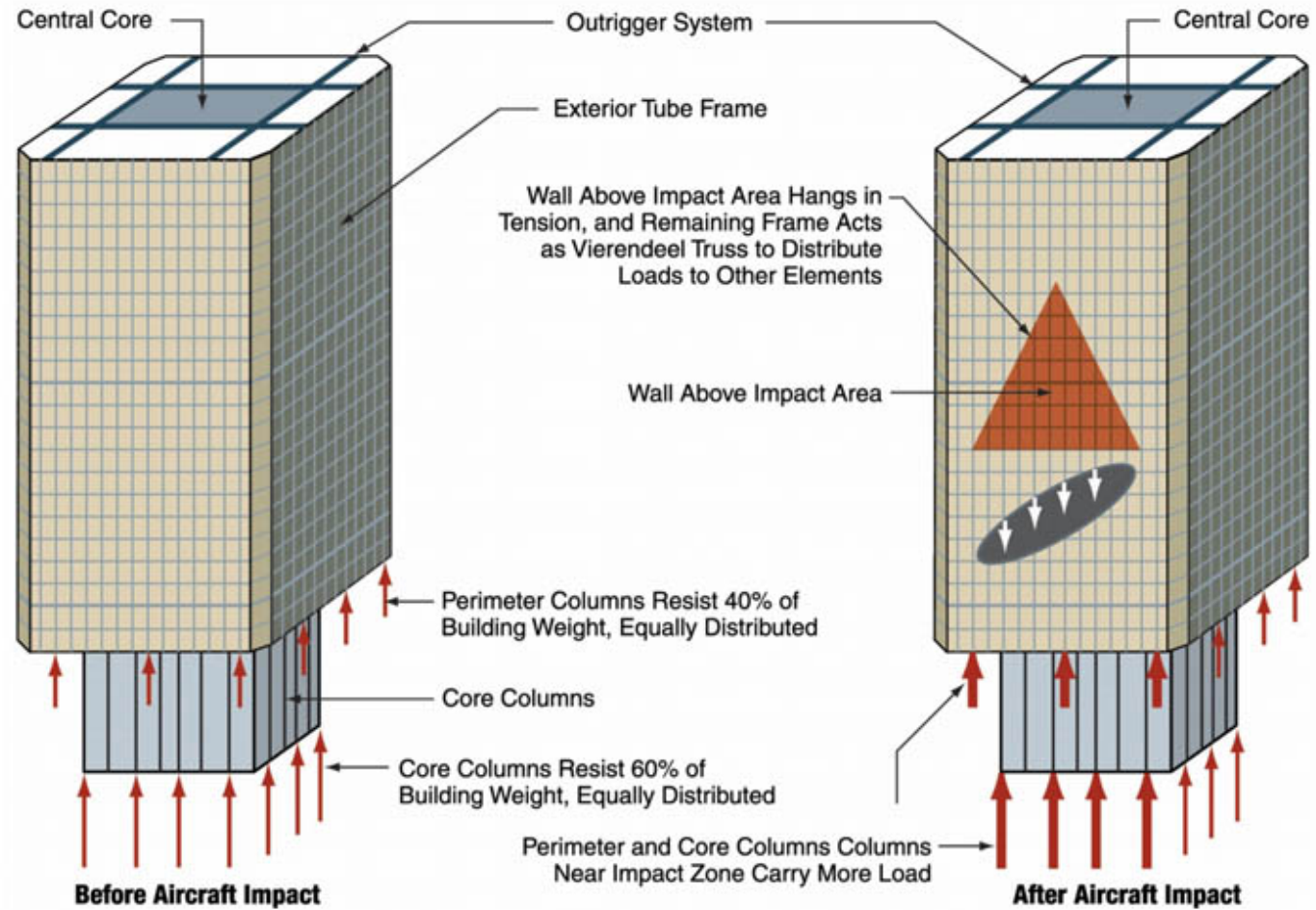


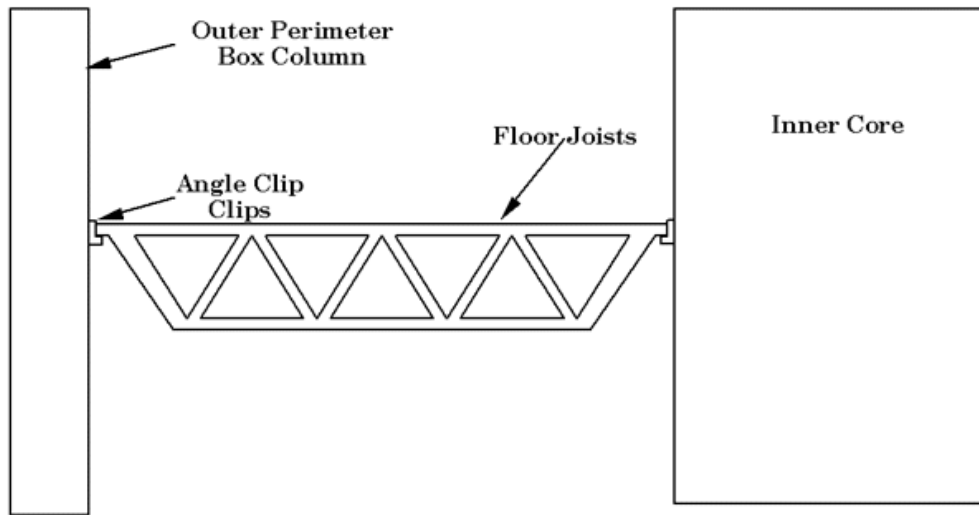
The building's perimeter columns and floor trusses form a steel lattice, which was designed to act as a wind brace, thereby keeping disturbance away from the central core.



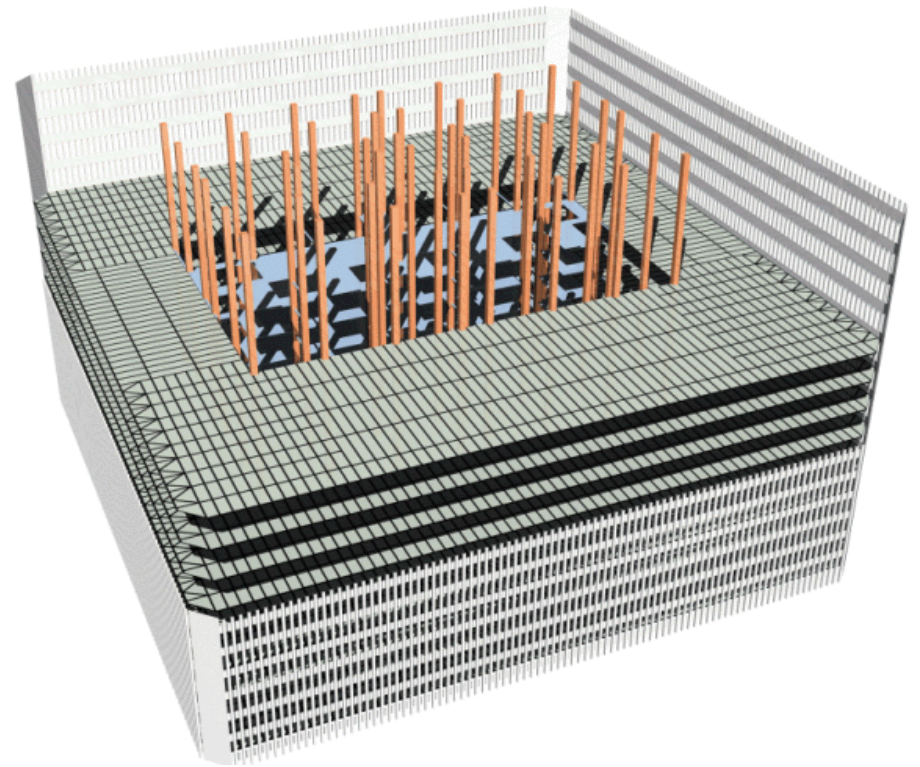
FLOOR PLAN OF THE WORLD TRADE CENTRE



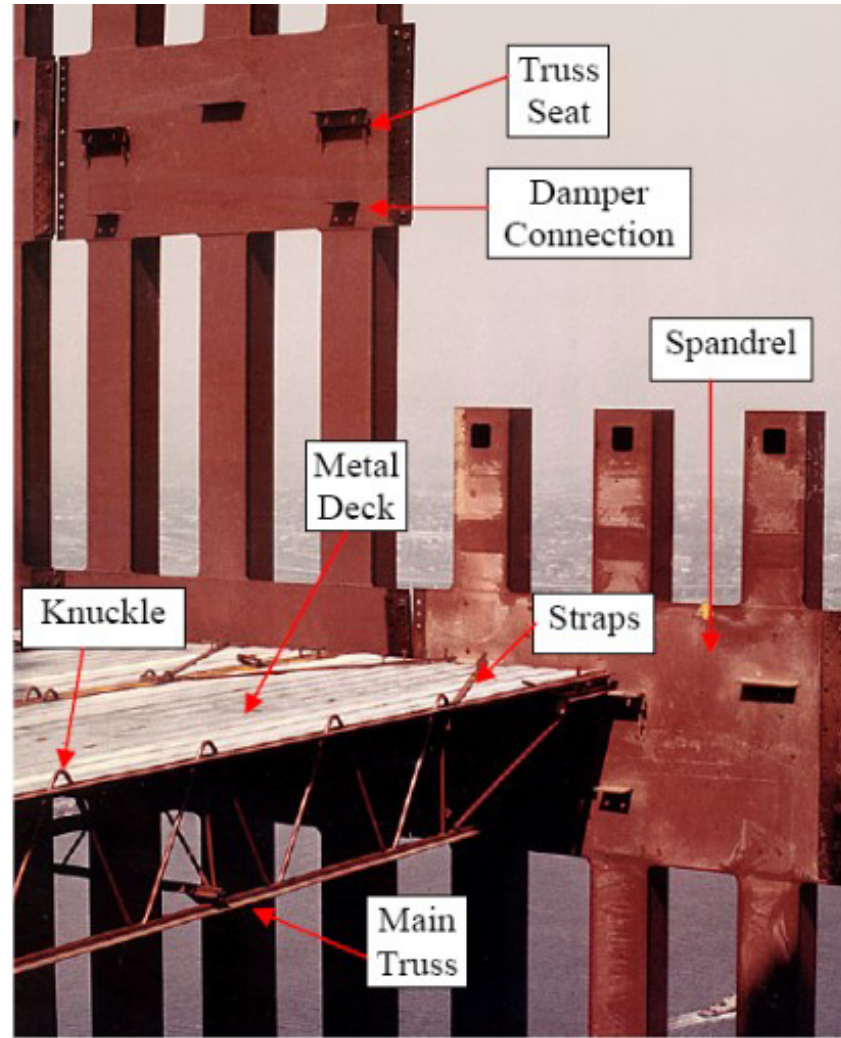
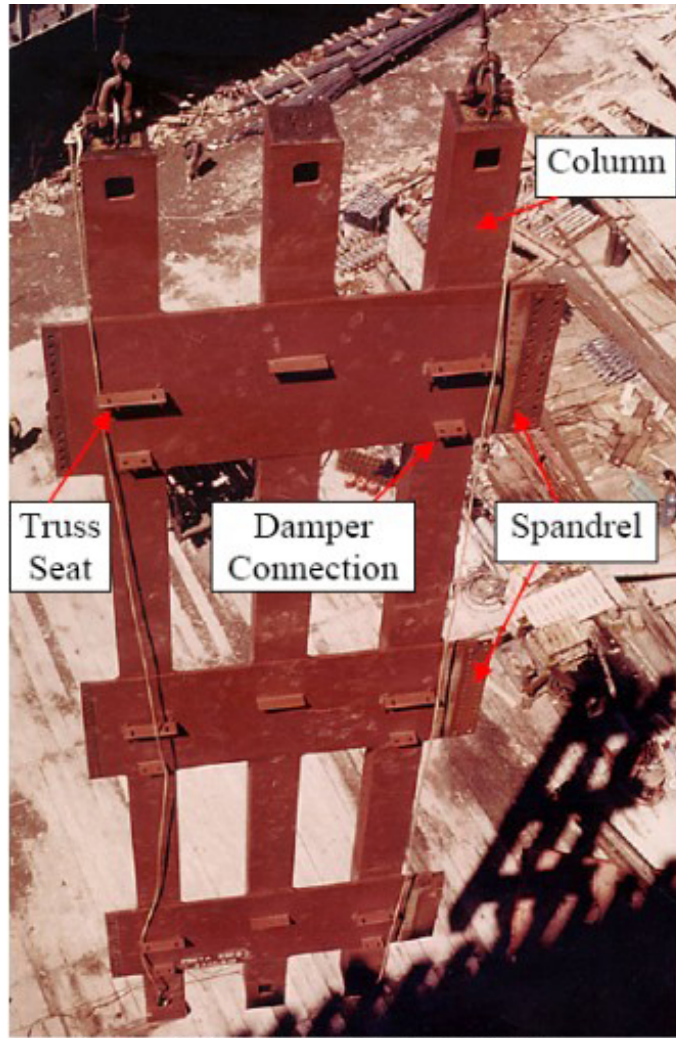




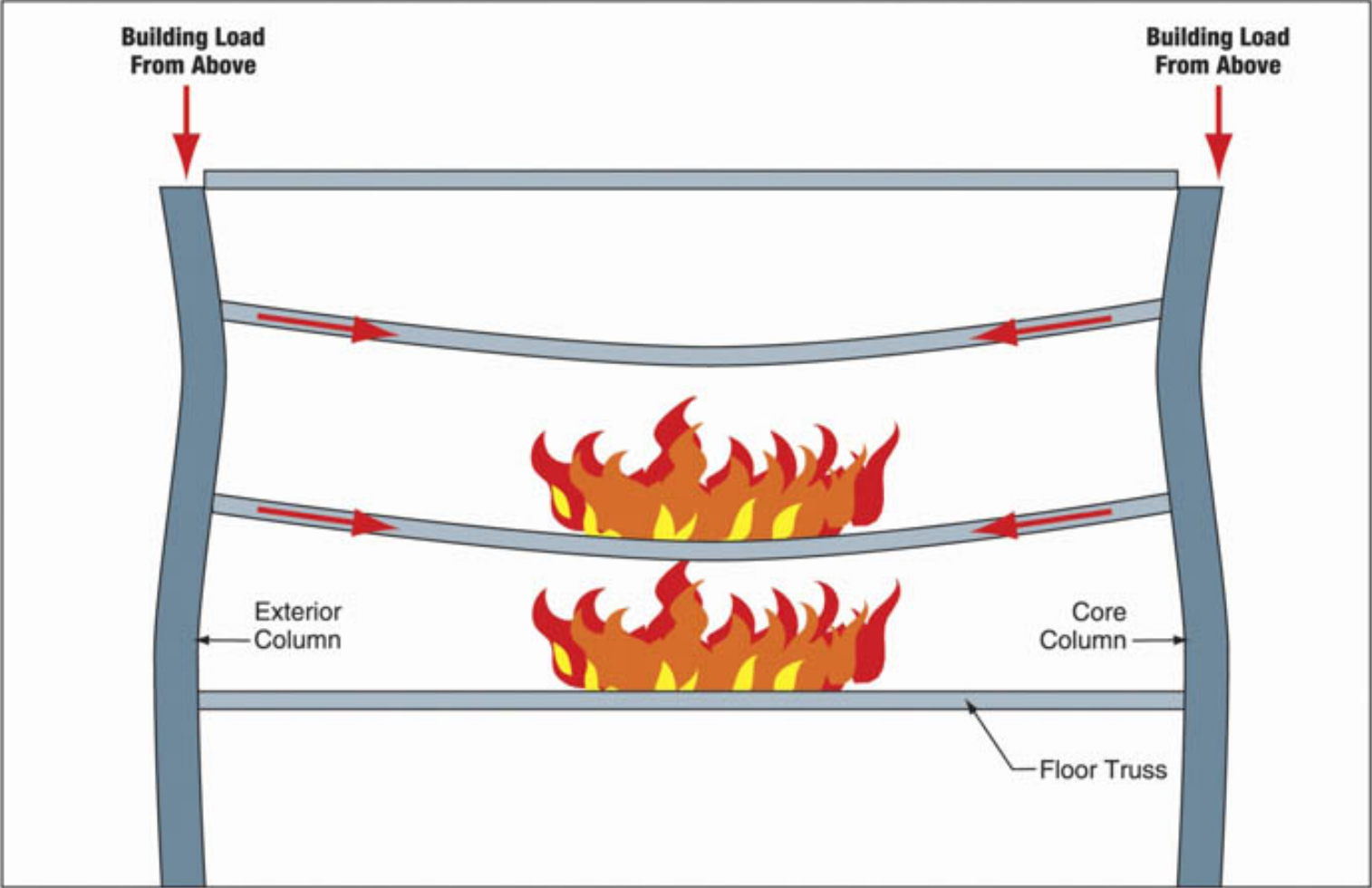
Part of the blame was structural, given the relatively weak hinge connection between the floor joists, core and outer wall.







Source: Unknown. Enhanced by NIST.



# Madrid Fire: February 205





## Dubai Torch: February 2015



## Dubai Torch: February 2015



Although this happened early in 2015, as of Feb 2016 it has still not been fixed. The building code in UAE has been changed to disallow this type of cladding, but they are not sure what to do about the hundreds of buildings where it is already in use.





The argument for fire resistant cladding. The issue with a cladding fire is that it spreads rapidly up the outside of the building and does not immediately activate smoke alarms and sprinklers.



# Remember:

- The Building Code and Fire Code provide Architects with a set of **MINIMUM** standards
- to be responsible, we must aim higher
- as the primary team leader in the design process, *we weigh the value of human life against economics*

