

Arch 125: Intro to Environmental Design

SOLAR GEOMETRY + ORIENTATION

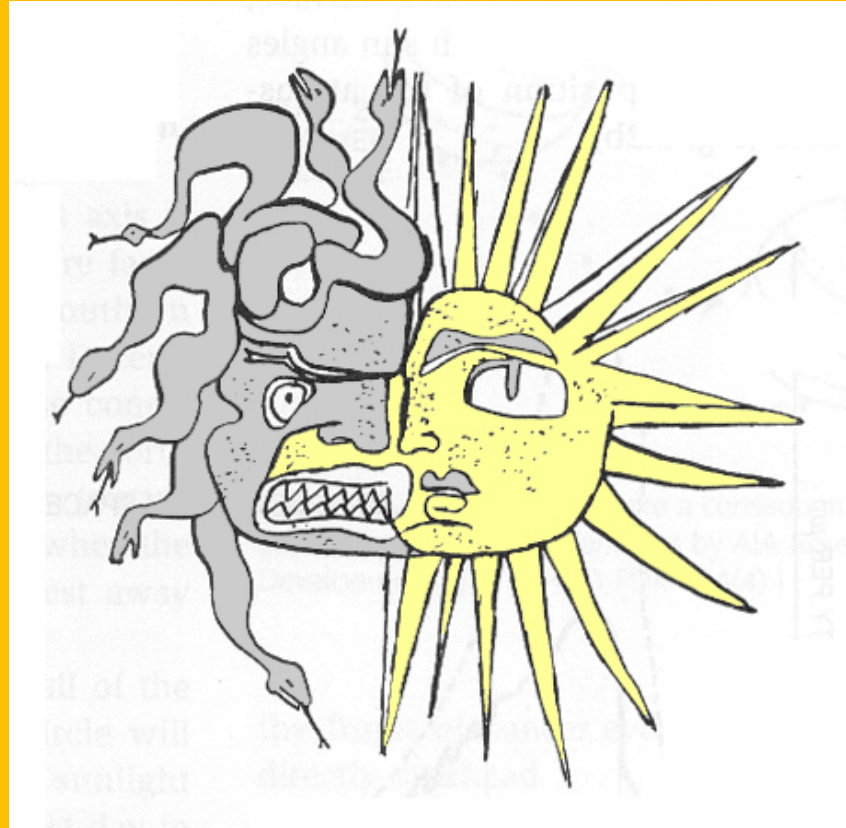

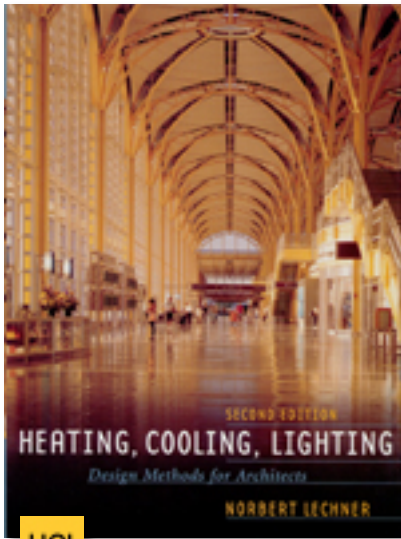

HCL



CBD



SWL



DWC



ECS

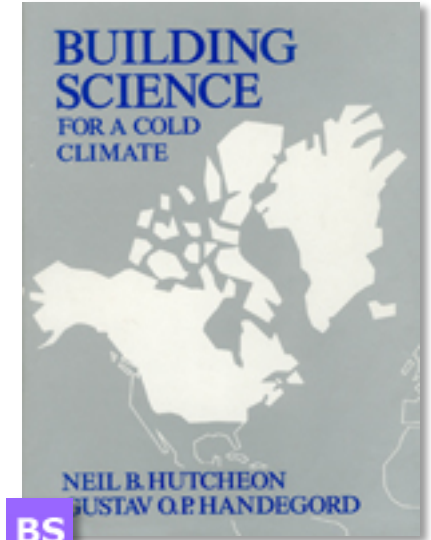

BS

Texts used in the preparation of this presentation.



There are large numbers of buildings that treat windows as patterning devices, and that do not take advantage of the sun in *obvious* ways.

In fact, the windows at the right ARE Morse Code.





...time of day affects windows...



Antoine Predock: Alumni Reception Hall, University of Minnesota

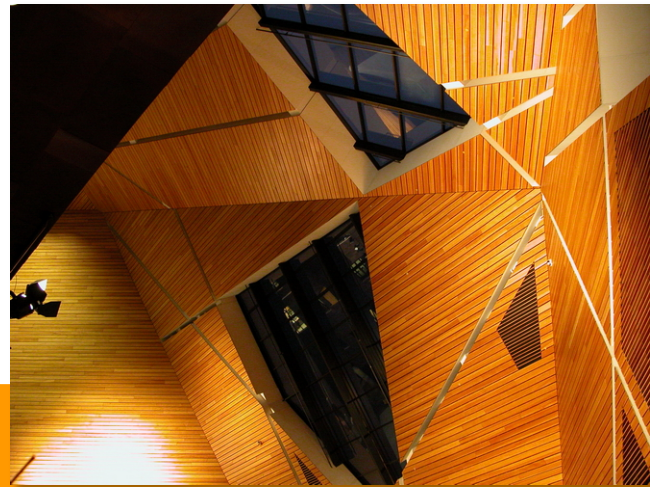

In studying Solar Geometry we are going to figure out how to use the sun's natural path in summer vs. winter to provide FREE heat in the Winter, and to reduce required COOLING in the summer + USE IT TO ANIMATE OUR SPACES.



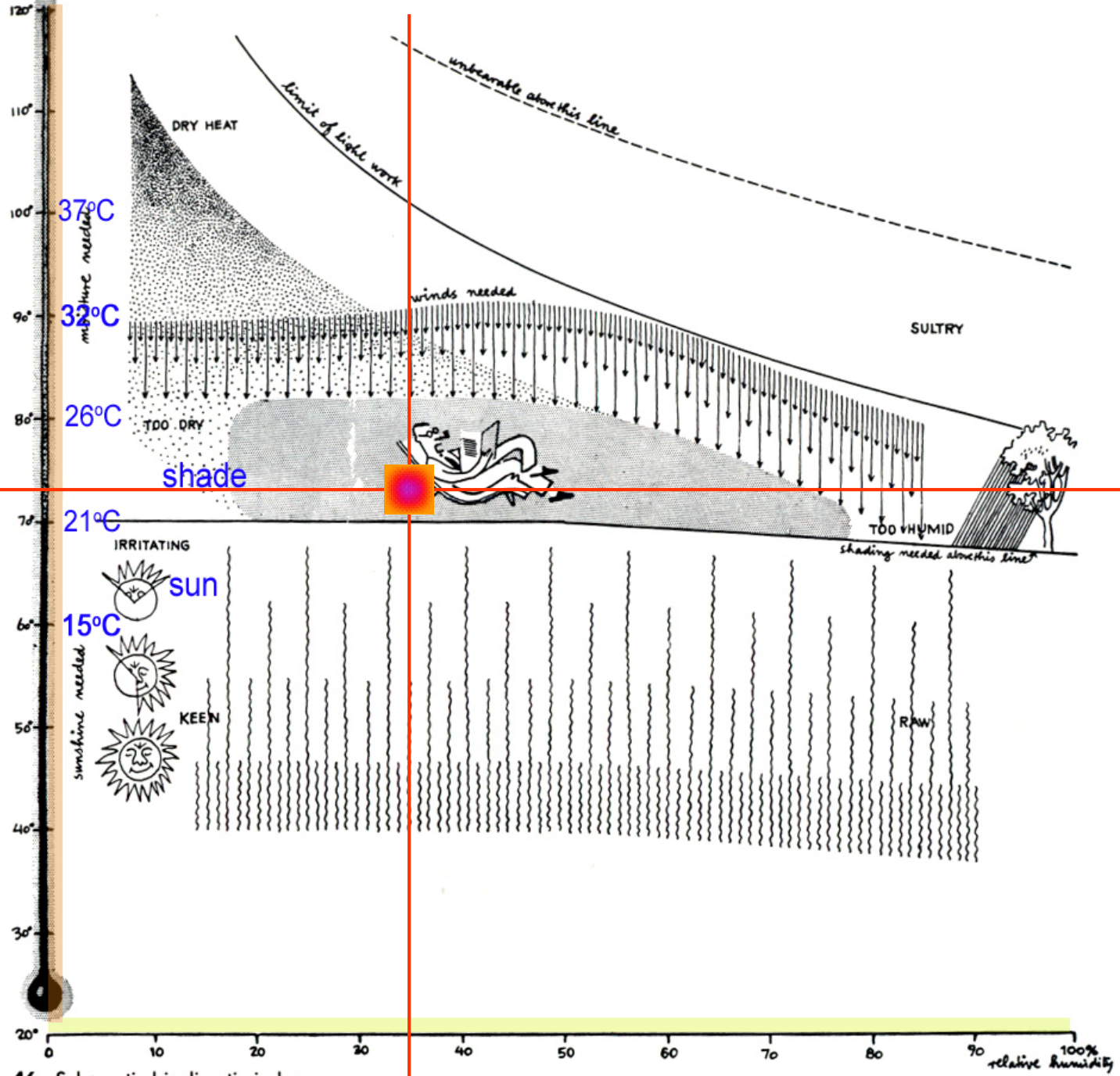

We use this chart to determine when we DO and DO NOT want sun penetration in and around our buildings.

DWC

46. Schematic bioclimatic index.

Why Solar Geometry?



Understanding solar geometry is essential in order to:

- do passive building design (for heating and cooling)
- orient buildings properly
- understand seasonal changes in the building and its surroundings
- design shading devices
- use the sun to animate our architecture



Solar geometry works for us because the sun is naturally HIGH in the summer, making it easy to block the sun with shading devices on south façades.



And it is naturally LOW in Winter, allowing the sun to penetrate below our shading devices and enter the building - with FREE heat.

The time zone is important as it affects “solar noon”. All charts are based on solar noon not the “hour noon”. Easiest way to find solar noon for your location is to note the sunrise and sunset times (in the paper/net) and solar noon is halfway in between.

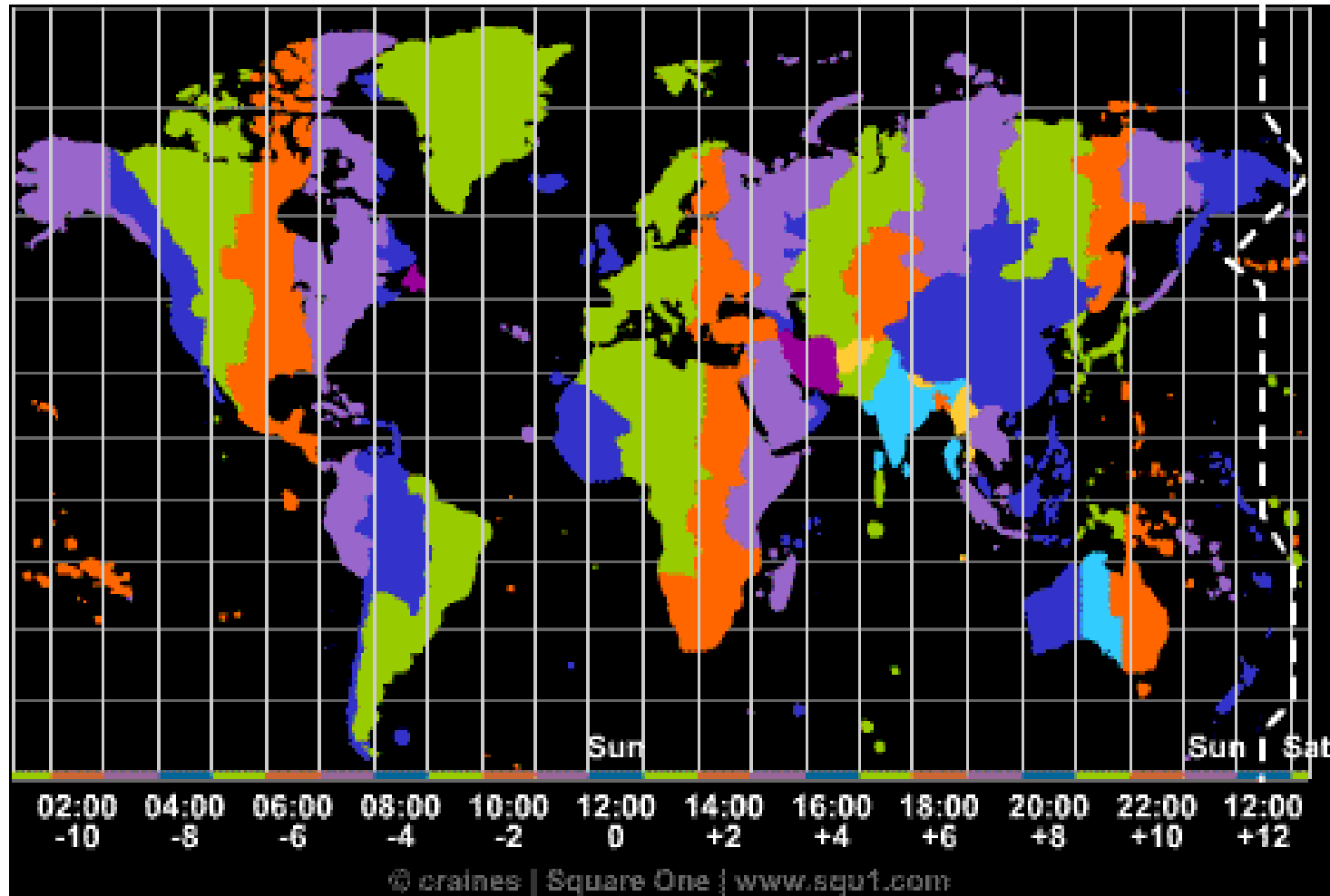

Detailed weather data is available online at:

http://www.weatheroffice.ec.gc.ca/city/pages/on-150_metric_e.html



For example: for
Collingwood, Ontario for
Sunday, Jan 22, 2006

Sunrise 7:50, Sunset
17:15, Moonrise 0:44,
Moonset 11:12

So... solar noon is
halfway between 7:50
and 17:15, so

$4:10 + 5:15 = 9:25 / 2 =$
 $4:42.5$ (4 hours 42.5
minutes),
so at 42.5 minutes after
12 noon.

Toronto was 7:44 and 17:14

The rotation of the earth about the sun affects the amount of solar radiation we receive at varying times of the year.

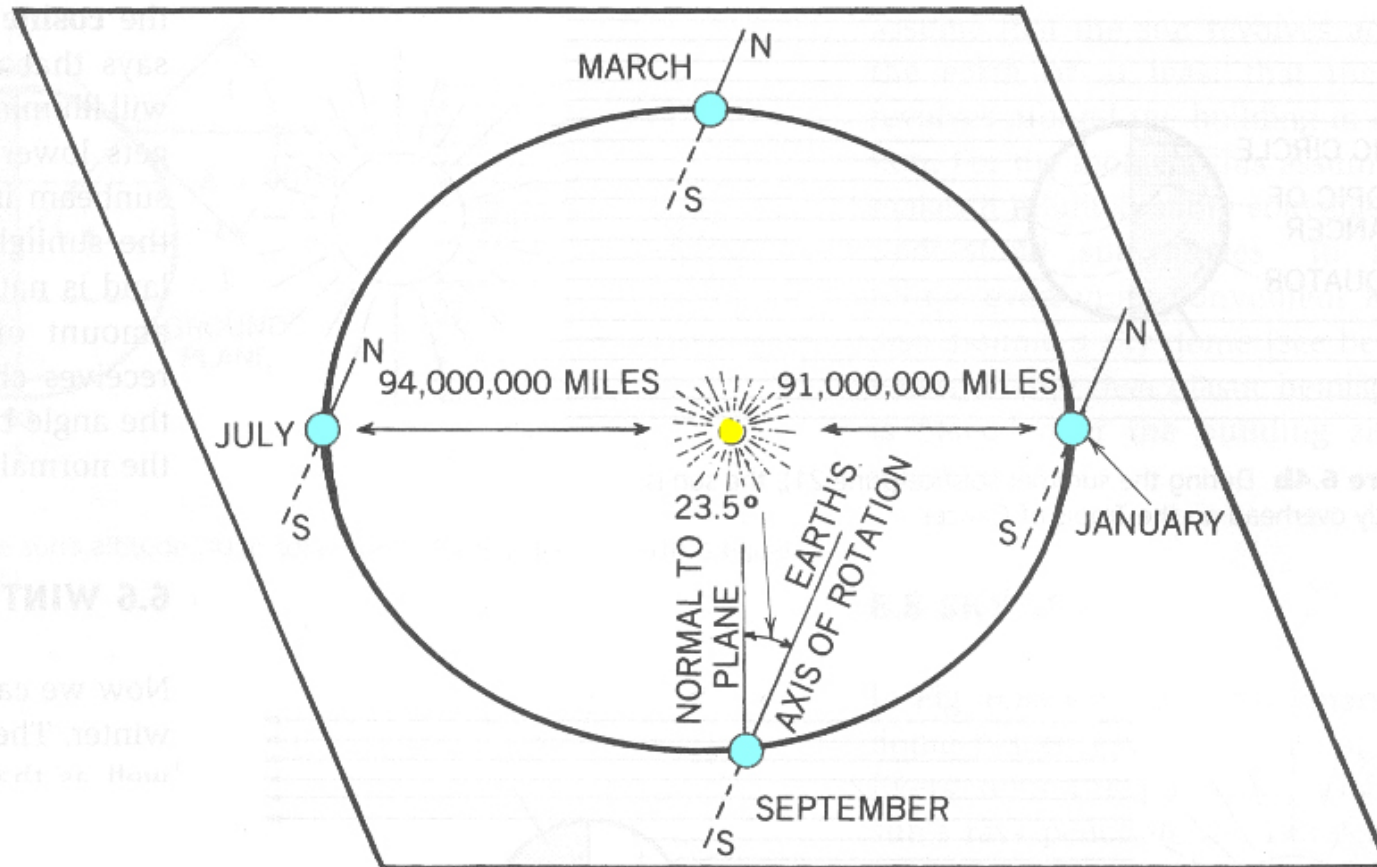
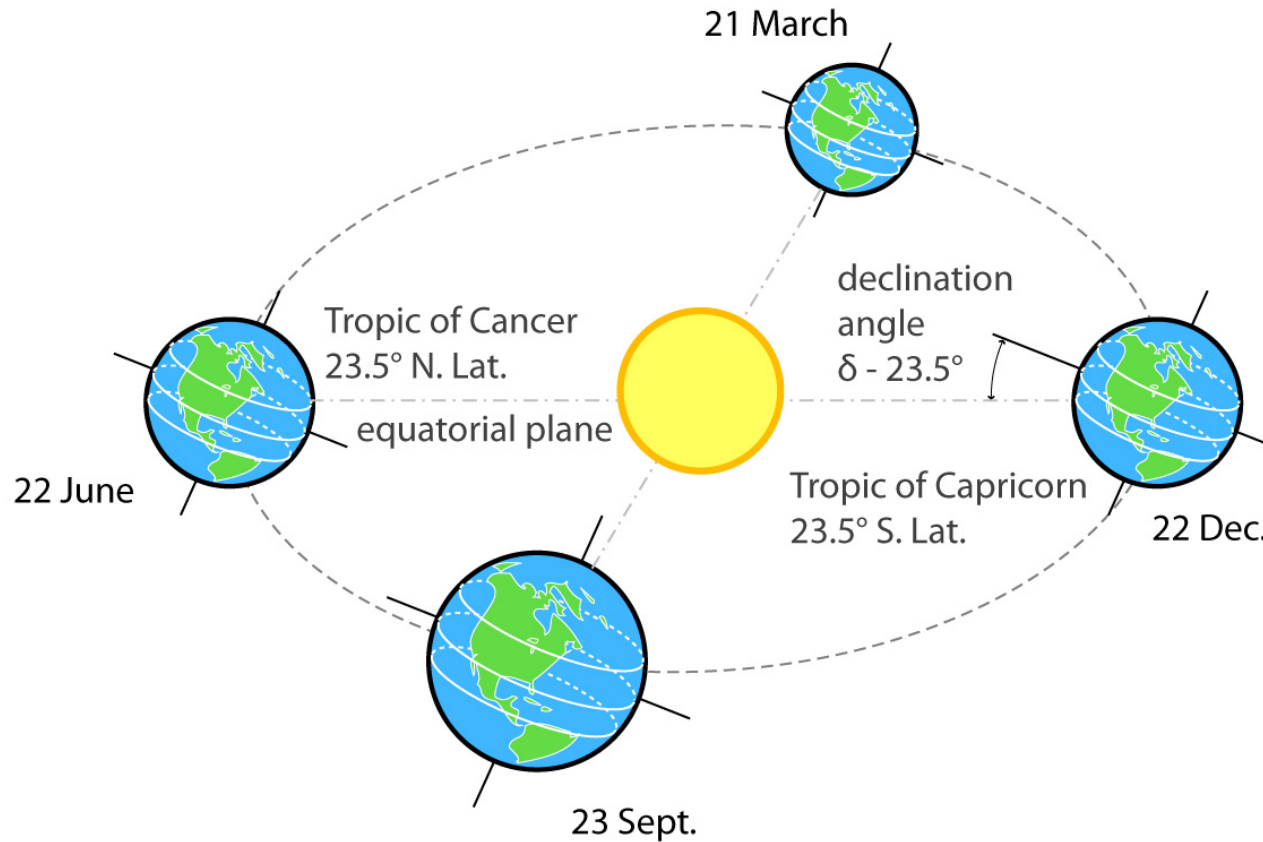

Figure 6.3 The earth's axis of rotation is tilted to the plane of the elliptical orbit.

Solar Position



Earth's motion around the sun.

Solar Position

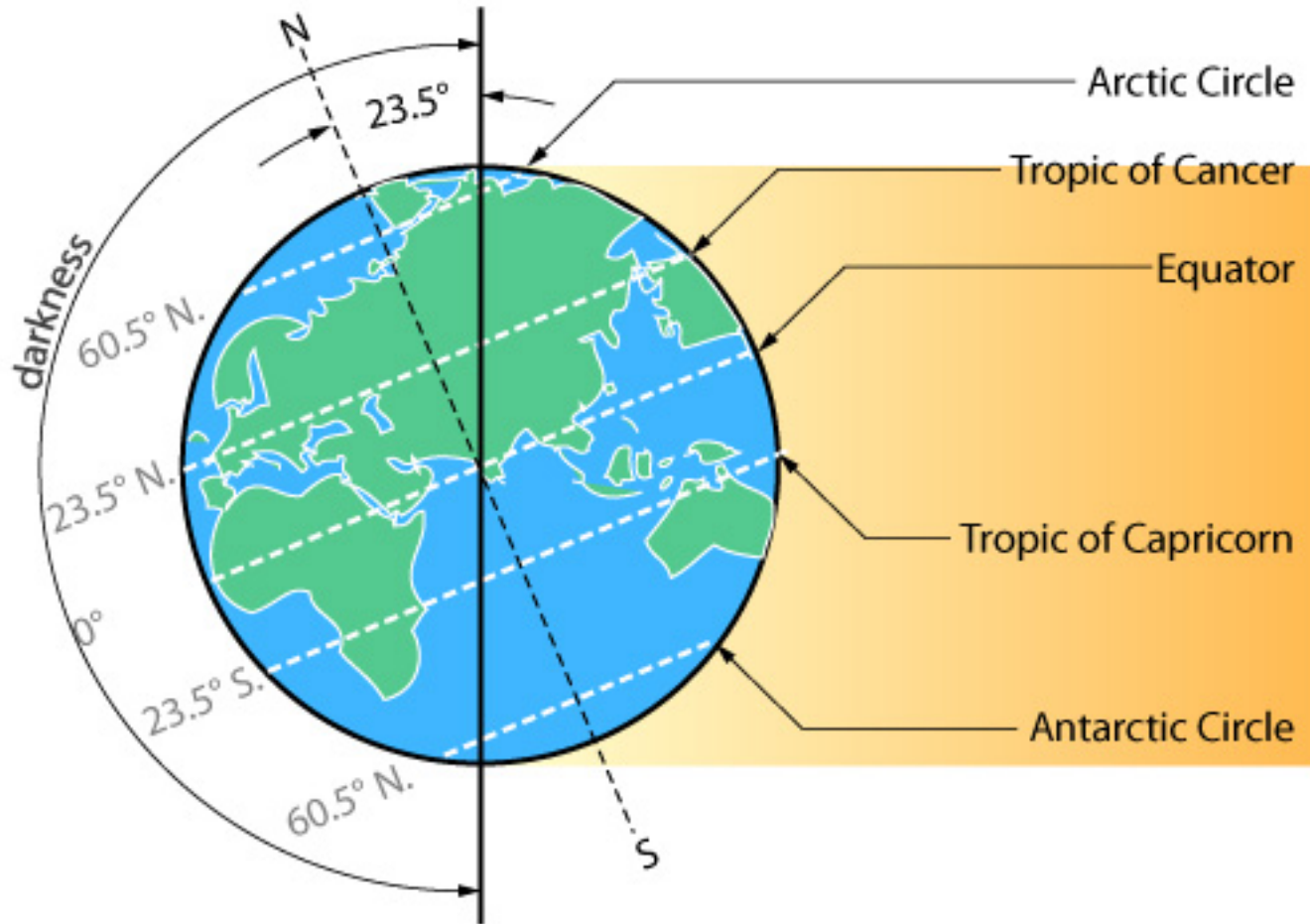

Earth relative to sun at winter solstice.

Solar Position

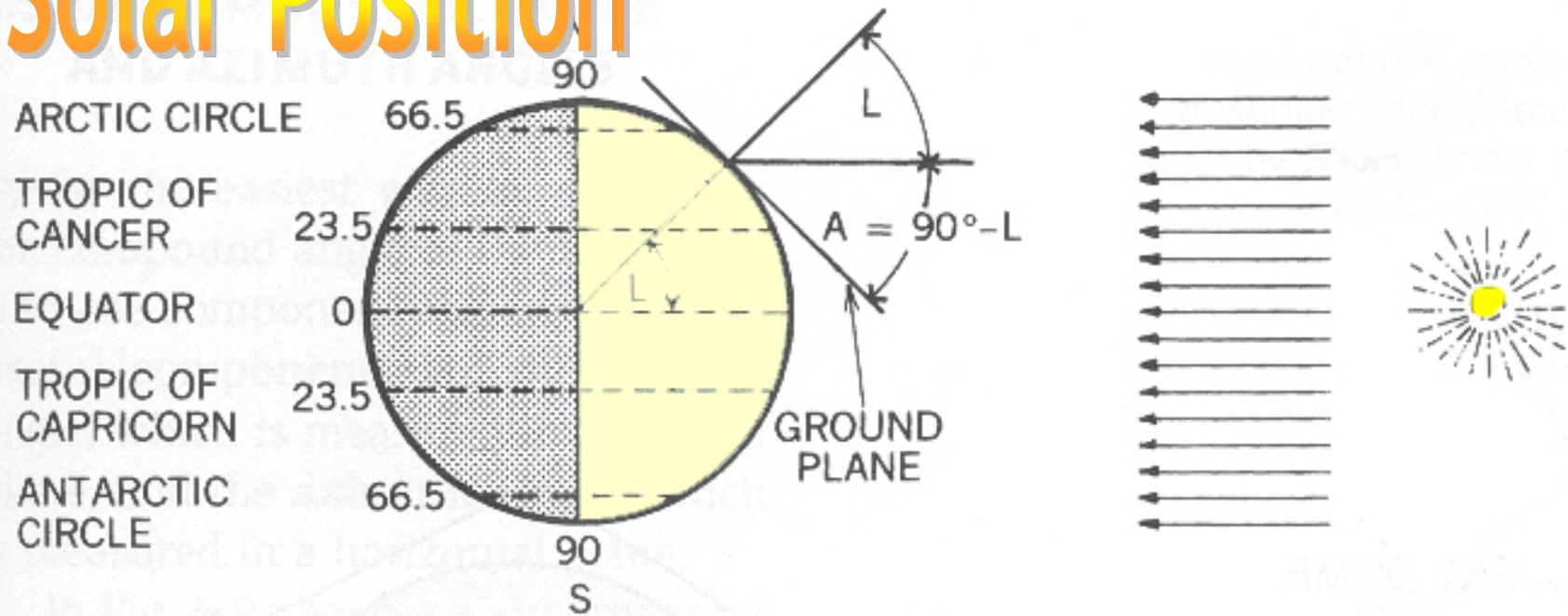
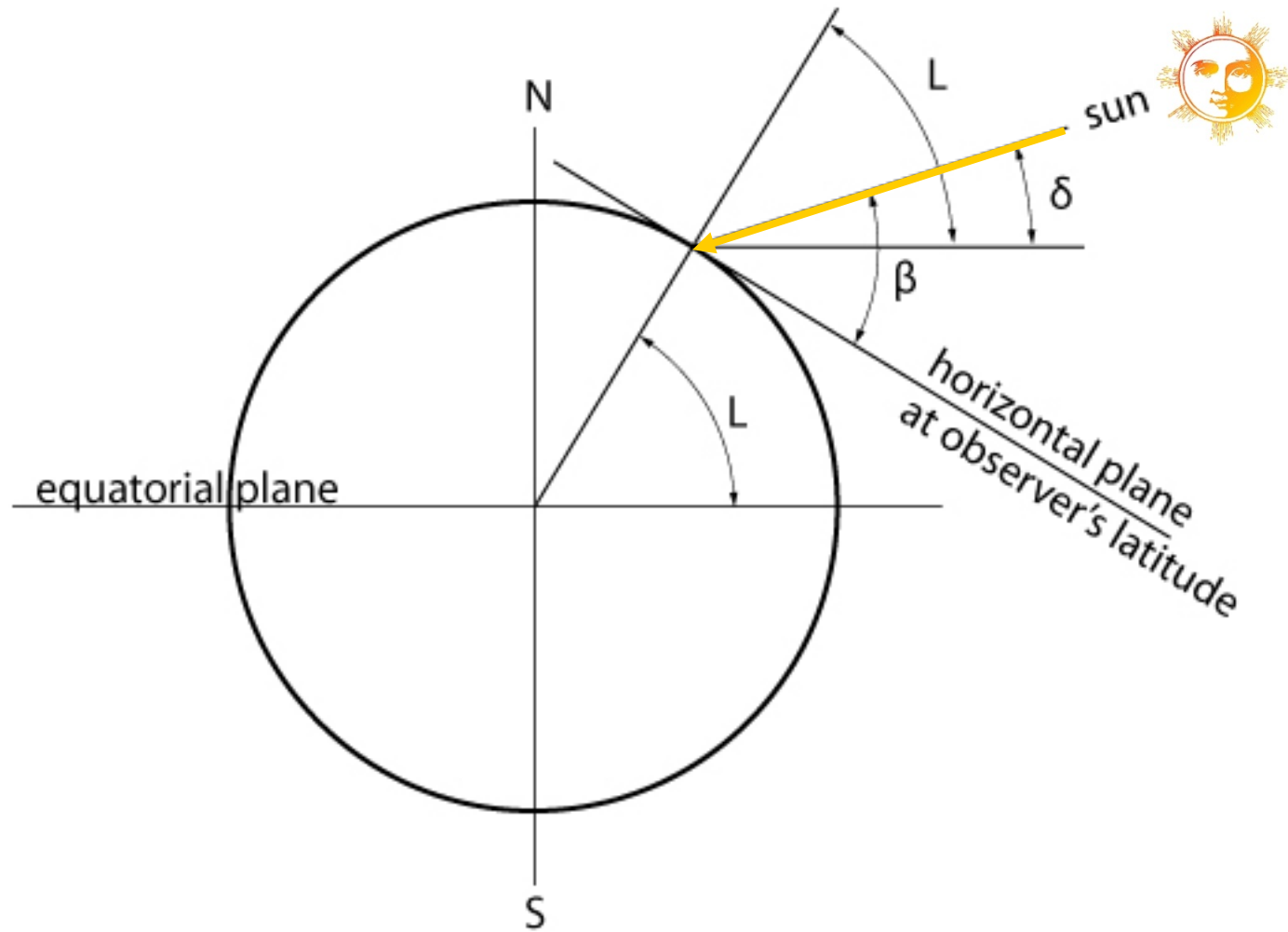

Figure 6.5a On the equinox, the sun's altitude (A) at solar noon at any place on earth is equal to 90 degrees minus the latitude (L).

HCL

The vertical angle at which the sun's rays strike the earth is called the 'altitude angle', and is a function of latitude, time of year and time of day. The simplest situation occurs at 12 noon on the equinox, when the sun's rays are perpendicular to the earth at equator. **Altitude Angle = $90^\circ - \text{Latitude}$**



Relation between declination, altitude angle, and latitude.

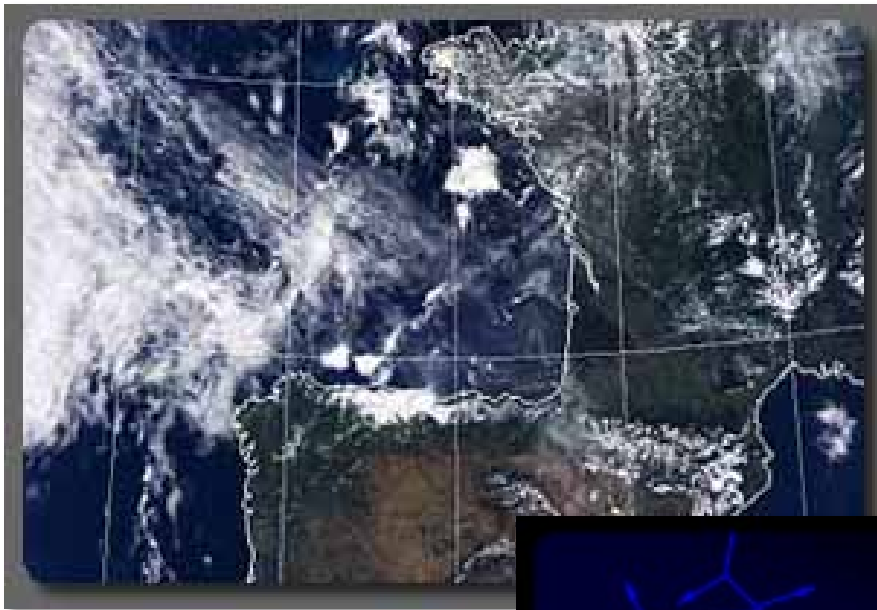

The exact nature of the solar radiation we receive is a function of our atmosphere.

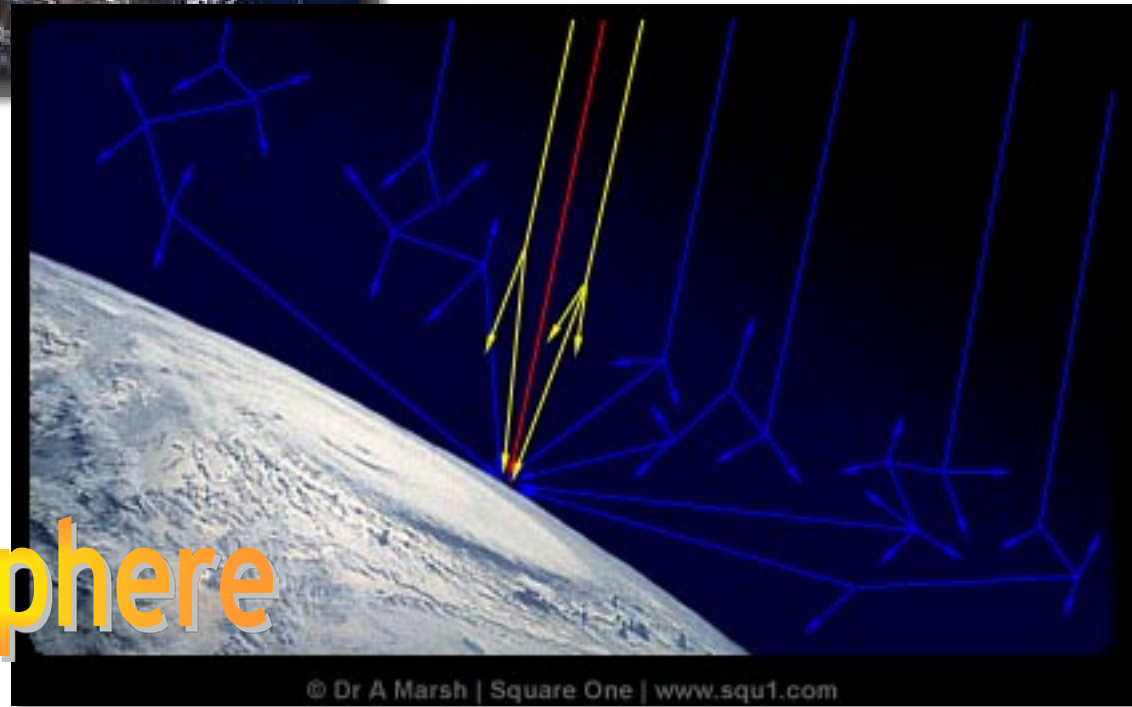

The Atmosphere

The Atmosphere

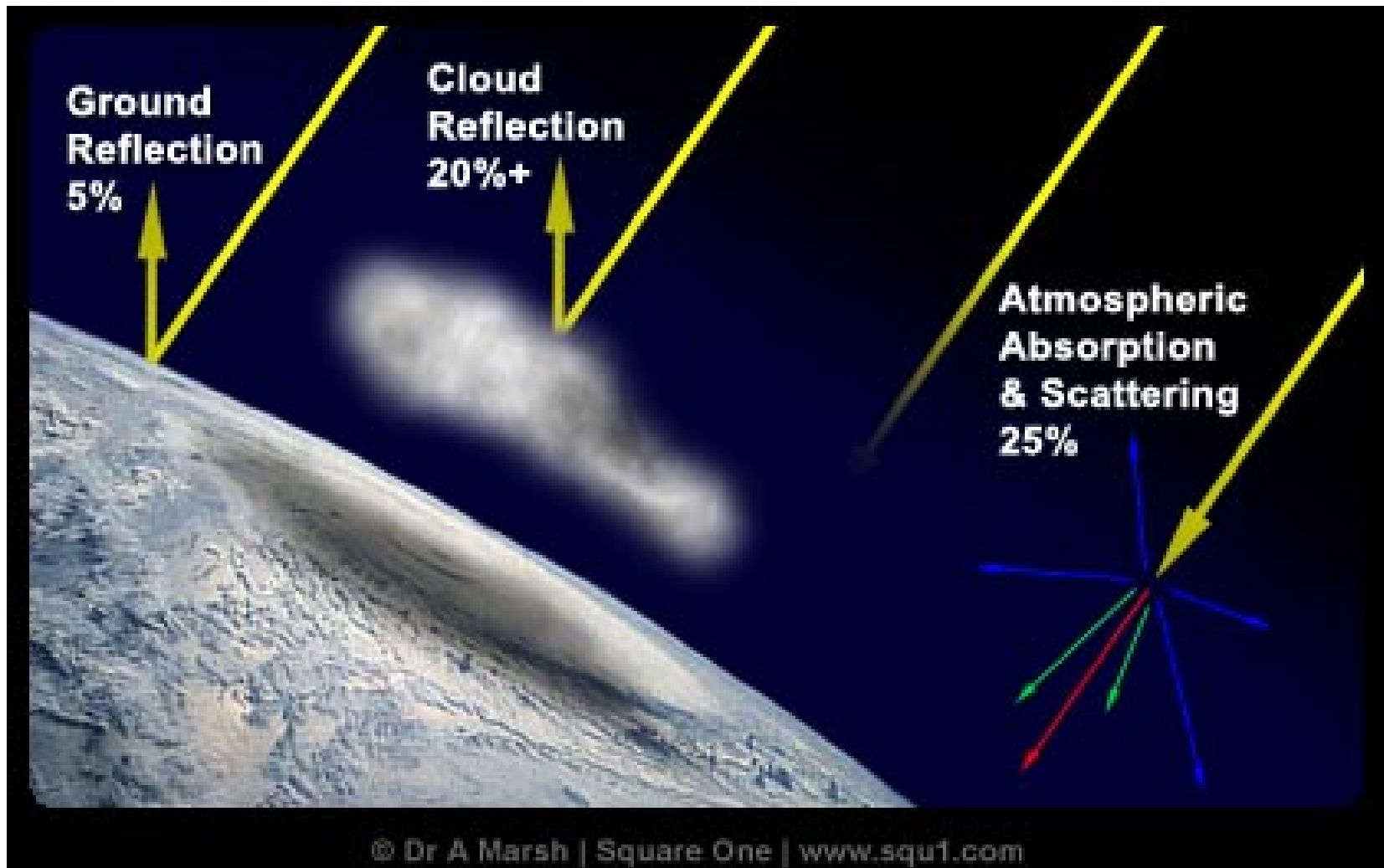

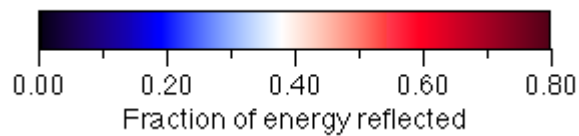
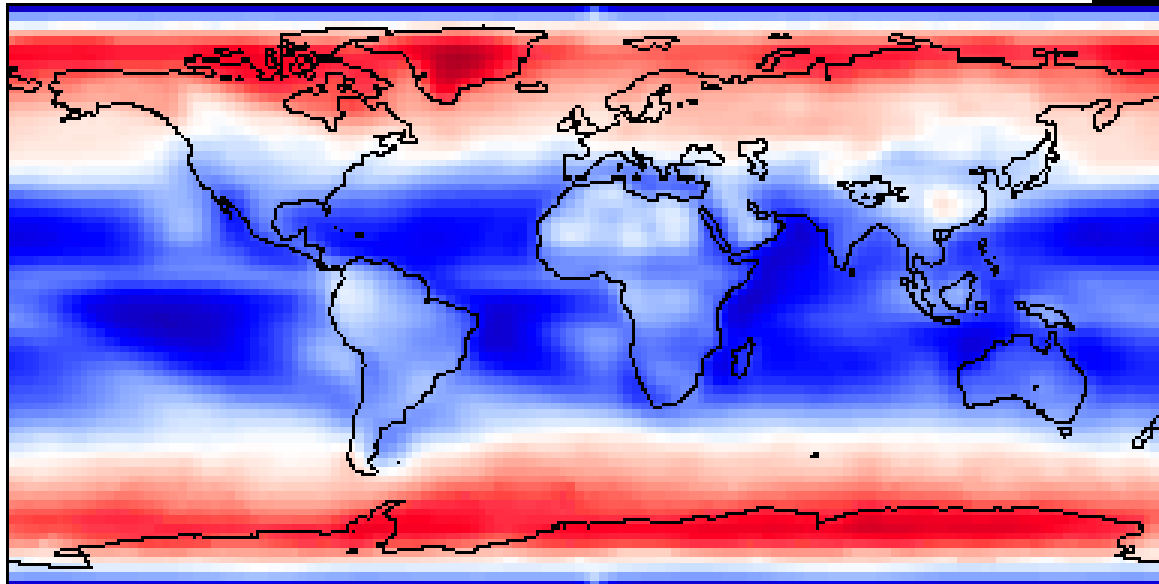

Not all solar radiation is absorbed by the earth - much is reflected and scattered. The image of the earth above shows more is collected where the sun passes through the atmosphere with less travel distance. It is also a function of cloud cover.

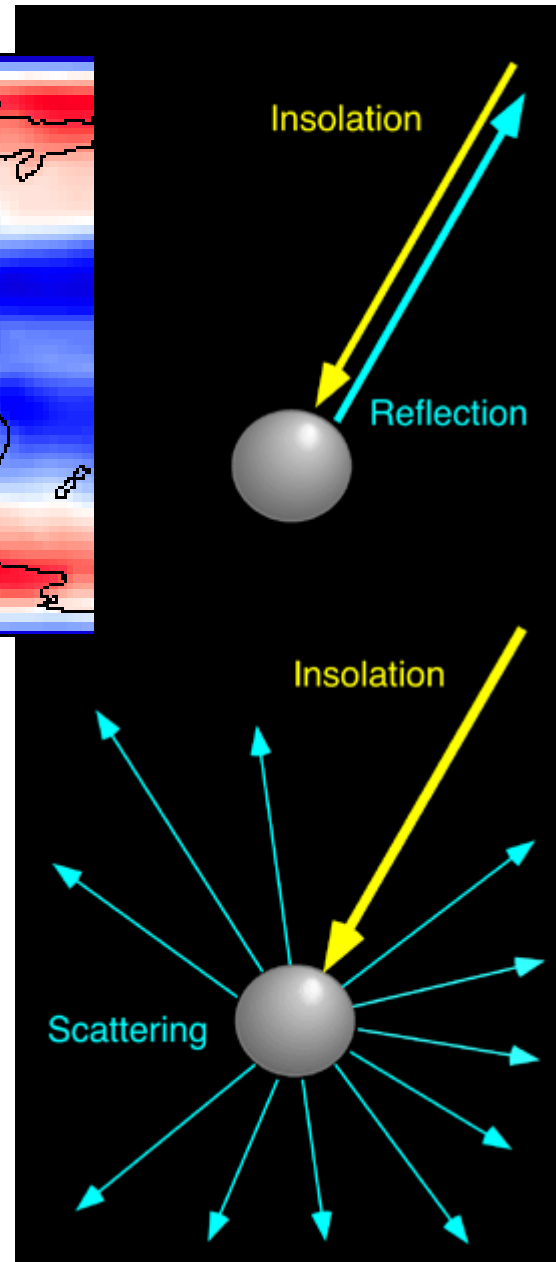

Part of the reason for the decrease in intensity in WINTER is the amount of radiation that is absorbed by the atmosphere during the longer trip through it by oblique rays.

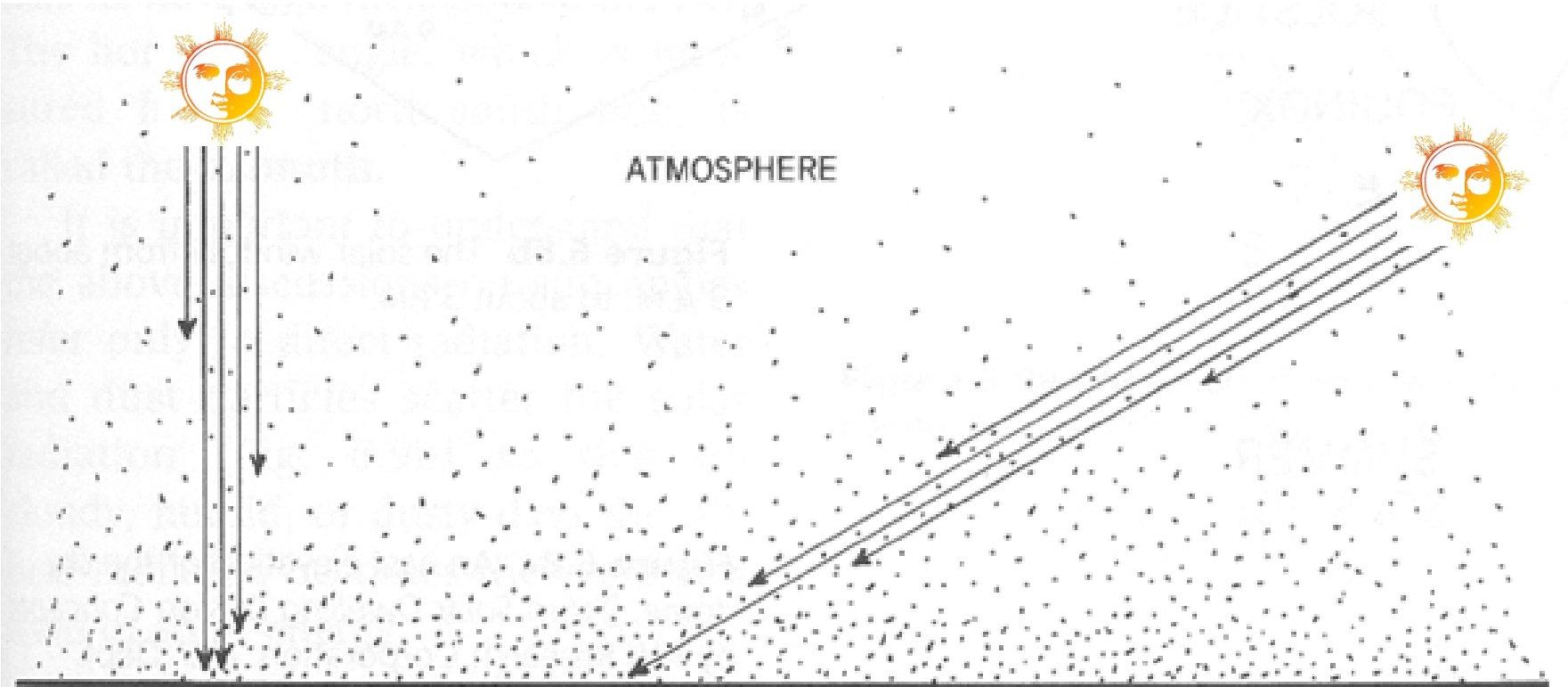

Figure 6.5b The altitude angle determines how much of the solar radiation will be absorbed by the atmosphere.

The angle the sun's rays make with the earth's surface also affects solar radiation levels. When the angle is oblique, the rays are less intense.

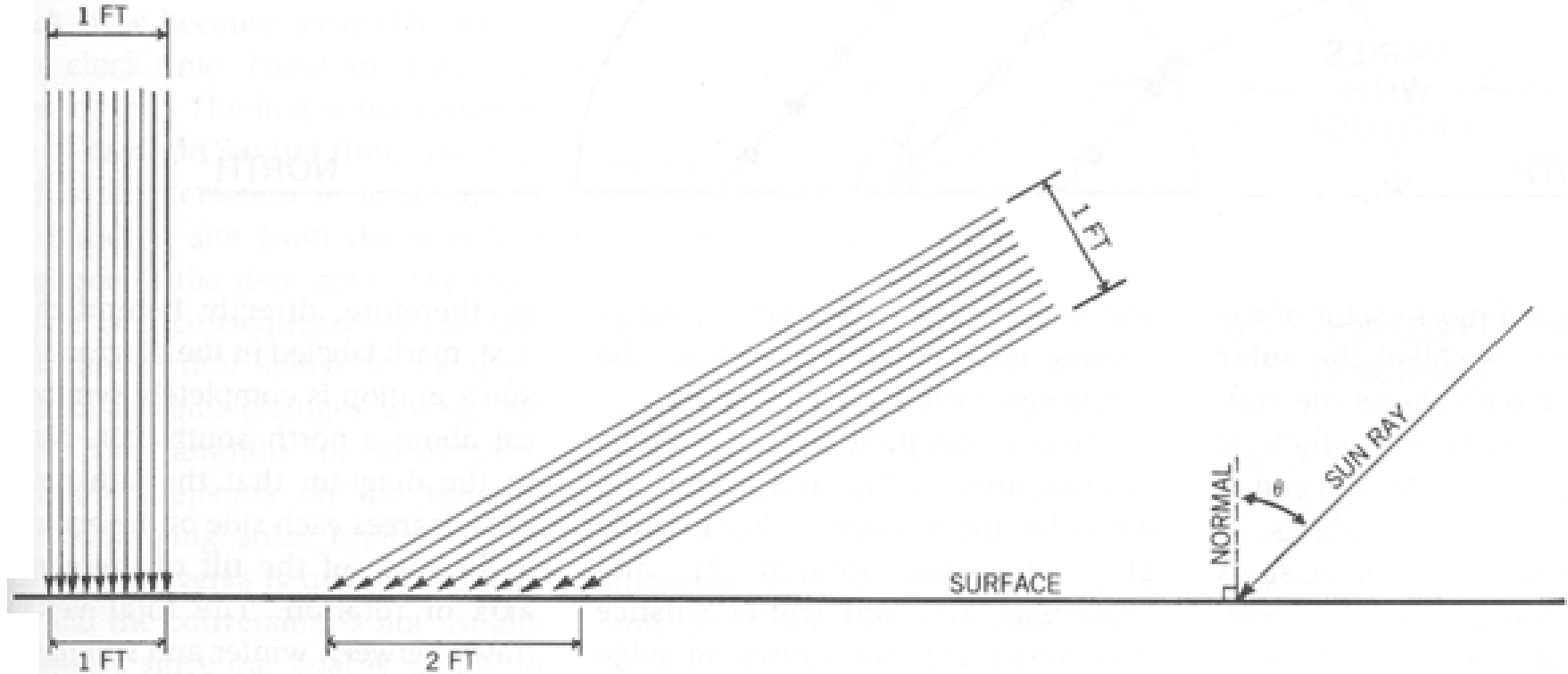

Figure 6.5c The cosine law states that the amount of radiation received by a surface decreases as the angle with the normal increases.



At low angles the sun's rays pass through more of the atmosphere - resulting in radiation reaching the surface being weaker -

i.e.: sunset

The wavelength of the light is also affected by its "clarity" and source.

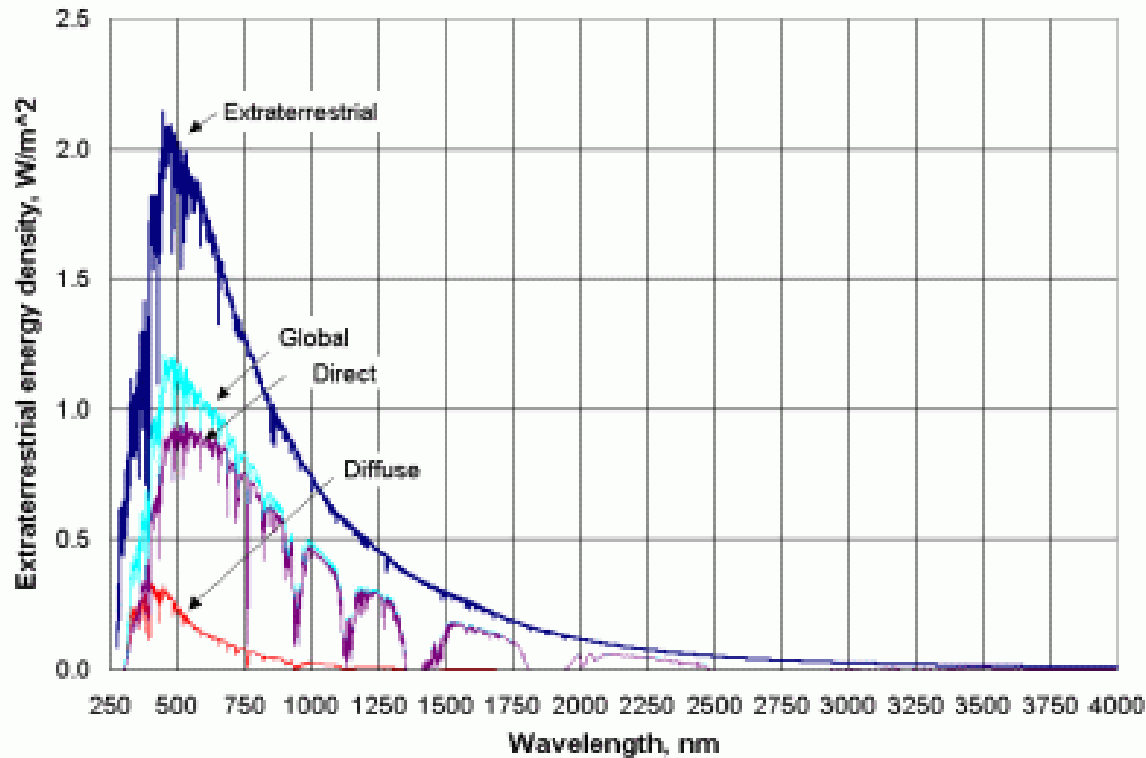
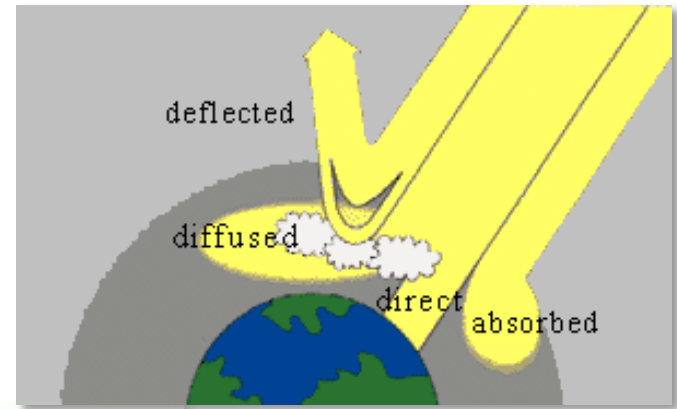

Reasons for Winter

The temperature of the air, and land is primarily a result of the amount of solar radiation absorbed by land.

Reasons for less radiation are:

1. Far fewer hours of daylight (6 hrs less at 40 degrees latitude on December 21st than June 21st)
2. Reduced solar radiation due to cosine law.
3. Lower sun angles increase amount of atmosphere the sun must pass through to get here



Solar "Attitude"

Copernicus is credited with establishing that the earth orbits around the sun -

However for the purposes of building design let's again assume that the sun revolves around the earth, or at least that the sun revolves around the building site in question.



Solar Altitude

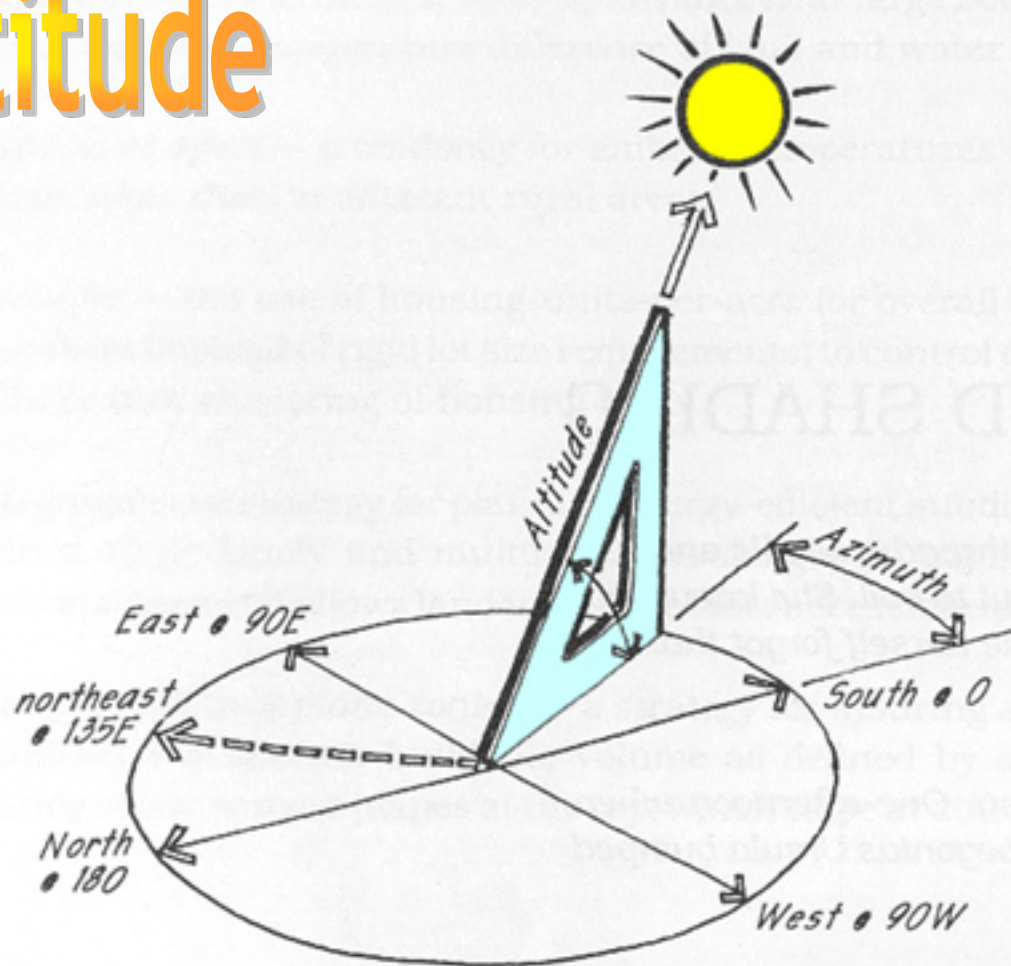
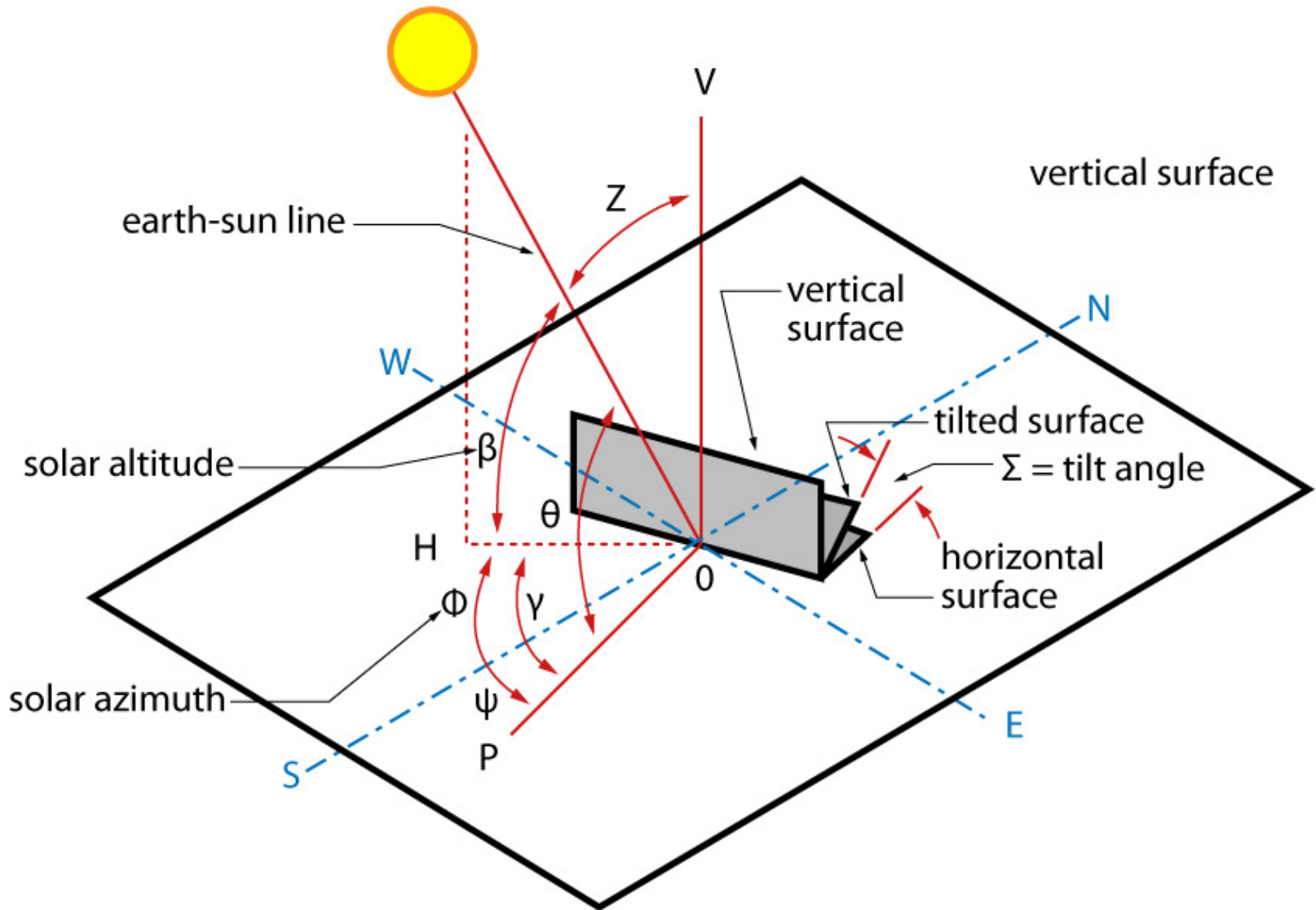
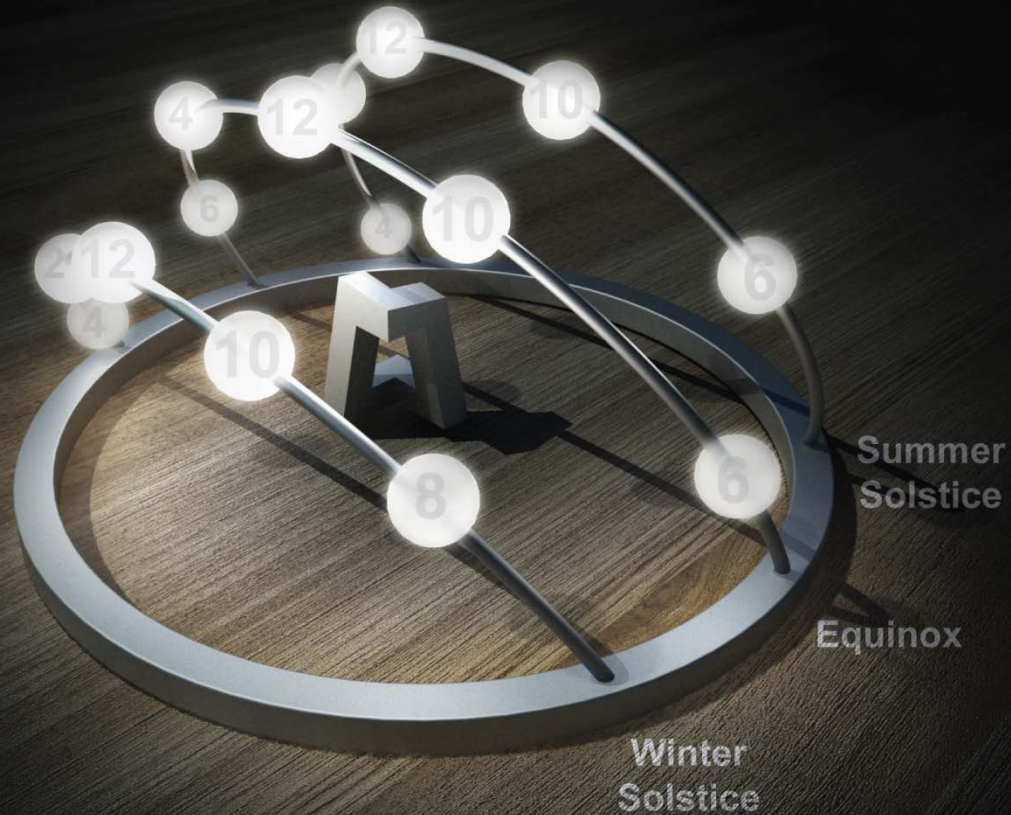

Figure 5.1: Solar azimuth and altitude angles. *Azimuth* angles are measured in each direction from south (for example, northeast = 135° E). *Altitude* angles are measured vertically from the horizon. (Reproduced from Moore, 1985, by permission.)



Sky Dome



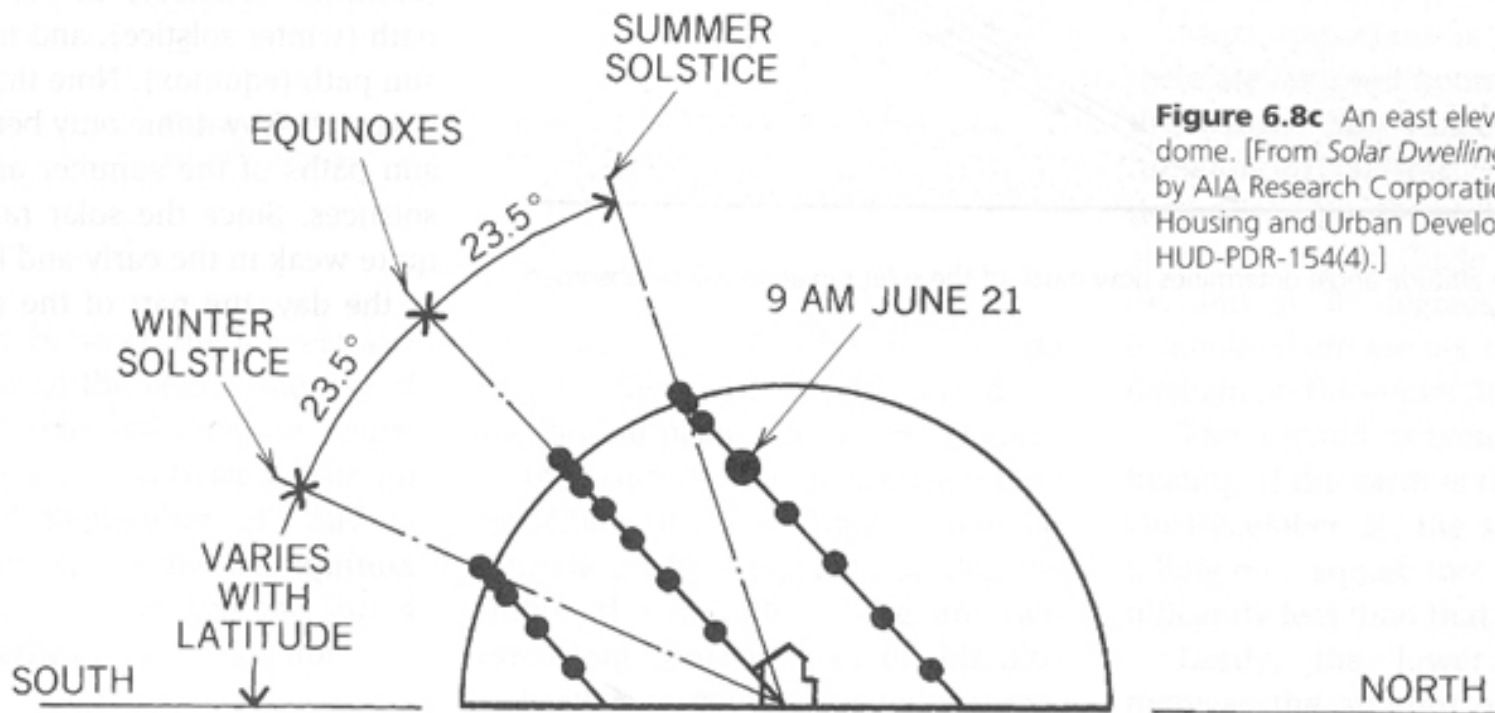

Figure 6.8c An east elevation of the sky dome. [From *Solar Dwelling Design Concepts* by AIA Research Corporation. U.S. Dept. Housing and Urban Development, 1976. HUD-PDR-154(4).]

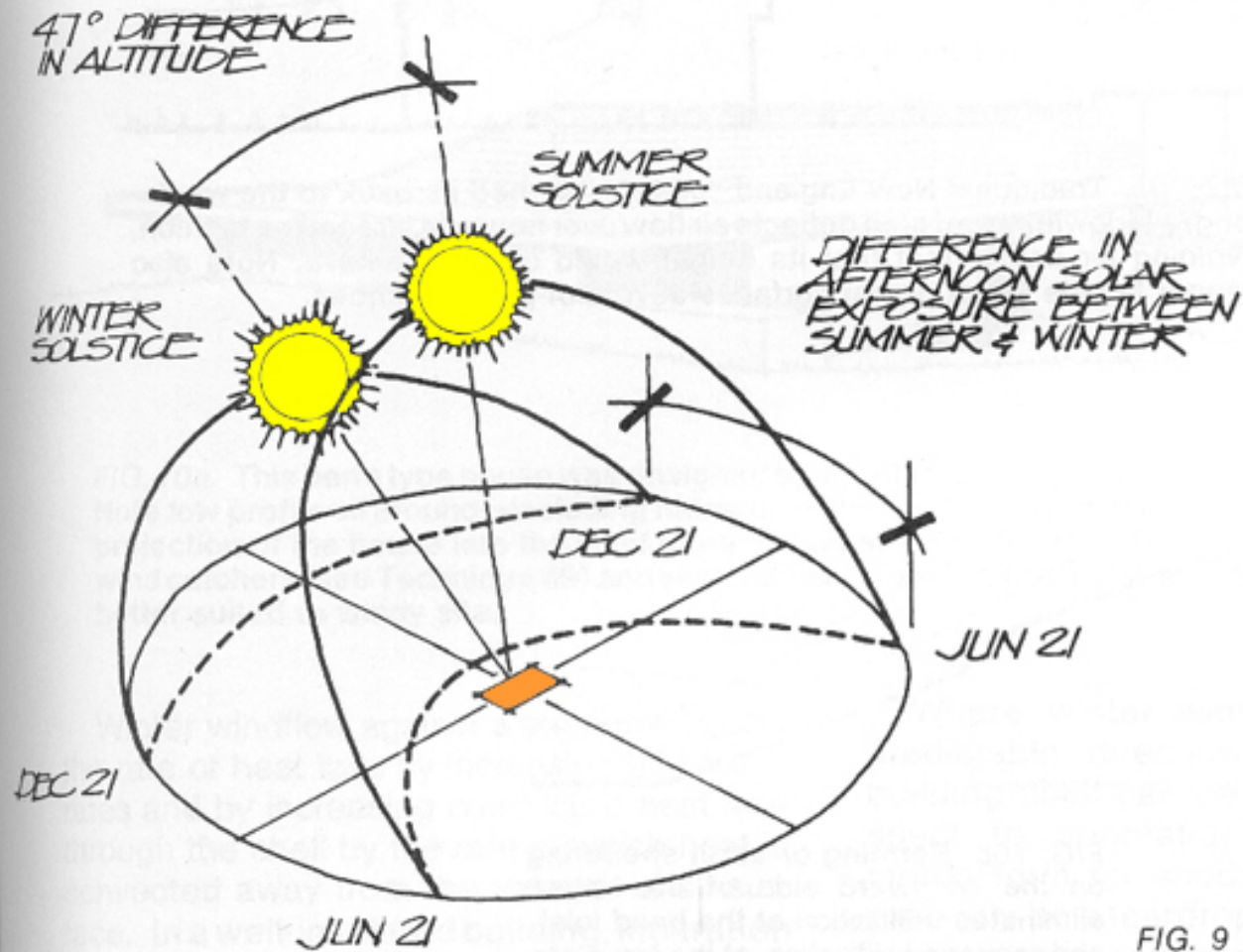

FIG. 9 Sunpath diagram illustrates that the only meaningful orientation for winter sun exposure is south. In summer, east and west exposures are the worst villains for overheating.

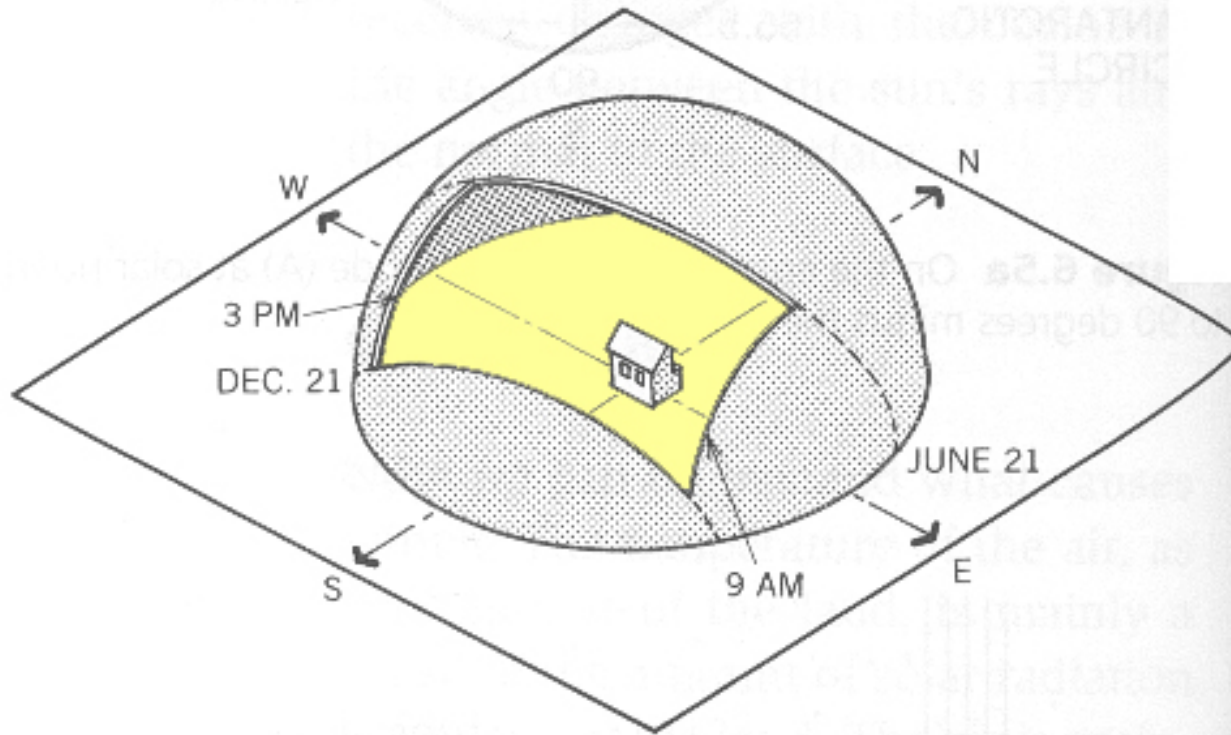
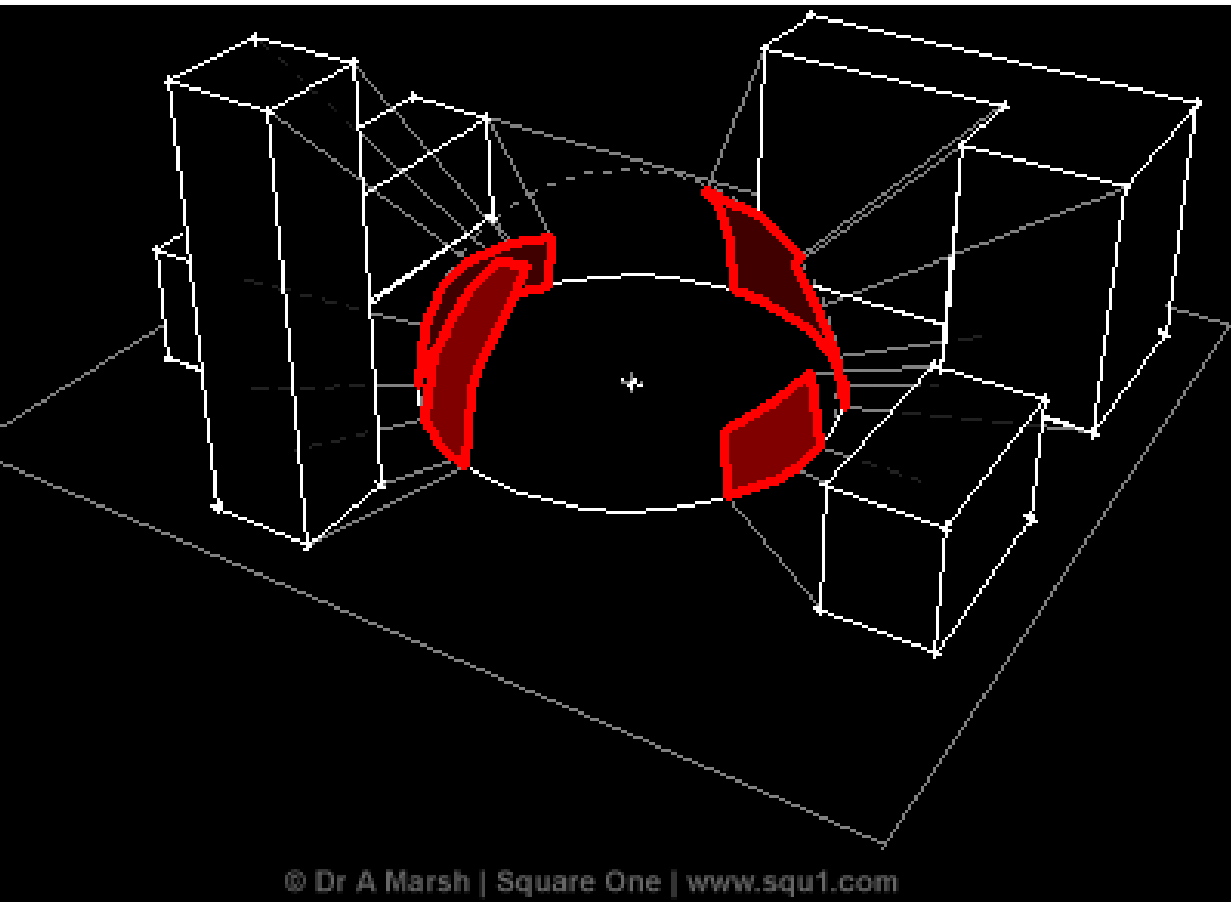

Figure 6.8b The solar window from about 9 A.M. to about 3 P.M.

HCL

- Space Heating - lower half of solar window, mostly desired in winter only
- Domestic Hot Water Heating - all year round

Surrounding buildings affect the view from the site to the sky.



As well as cast shadows on the site.

Derivation of Sun Path Diagrams

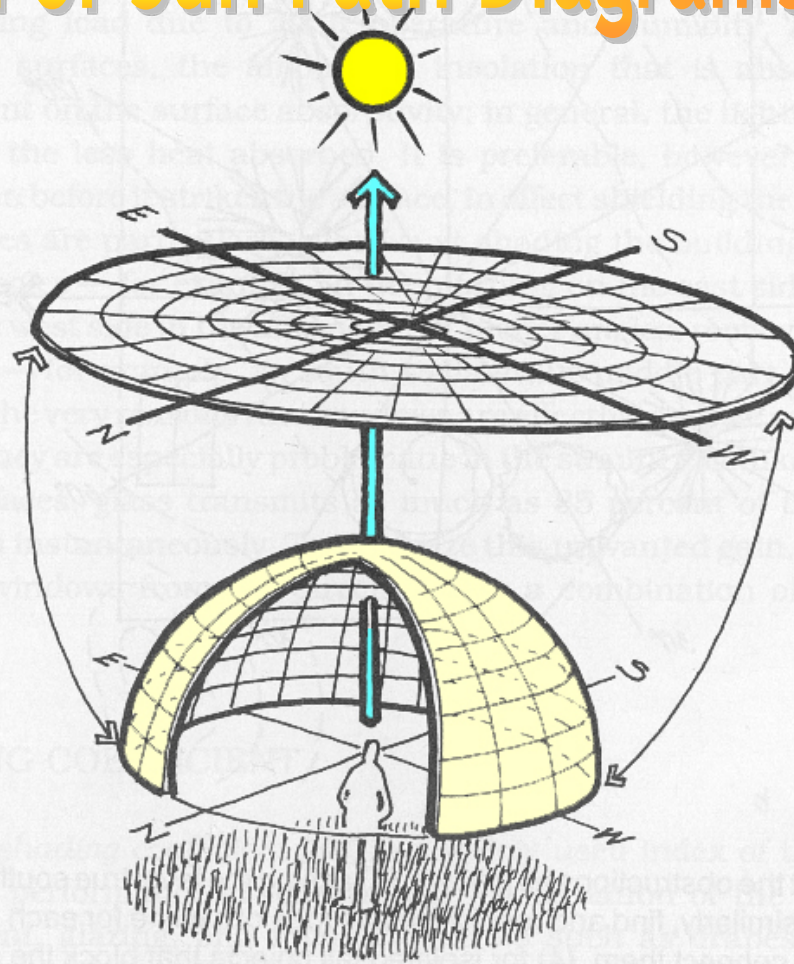

Figure 5.8: Sky dome, with equidistant plan projection showing azimuth and altitude coordinates. (Reproduced from Moore, 1985, by permission.)

Horizontal Projection Sun Path Diagram

Vertical Projection Sun Path Diagram

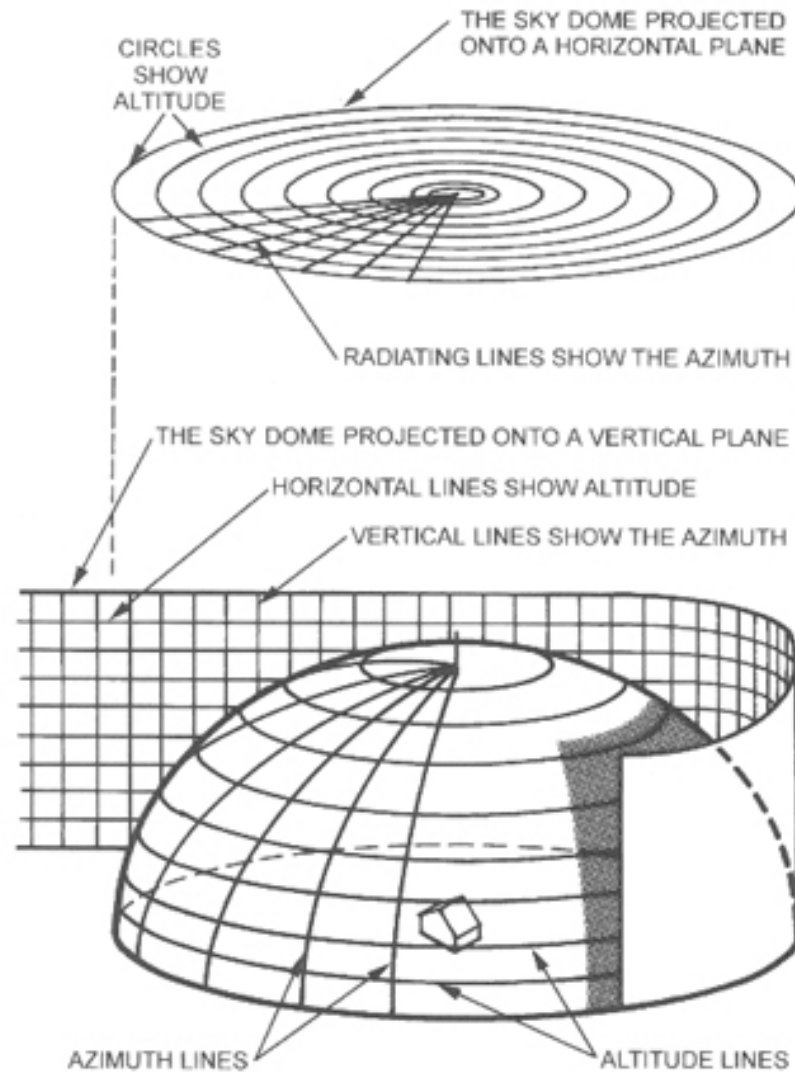

Figure 6.11a Derivation of the horizontal and vertical sun path diagrams.

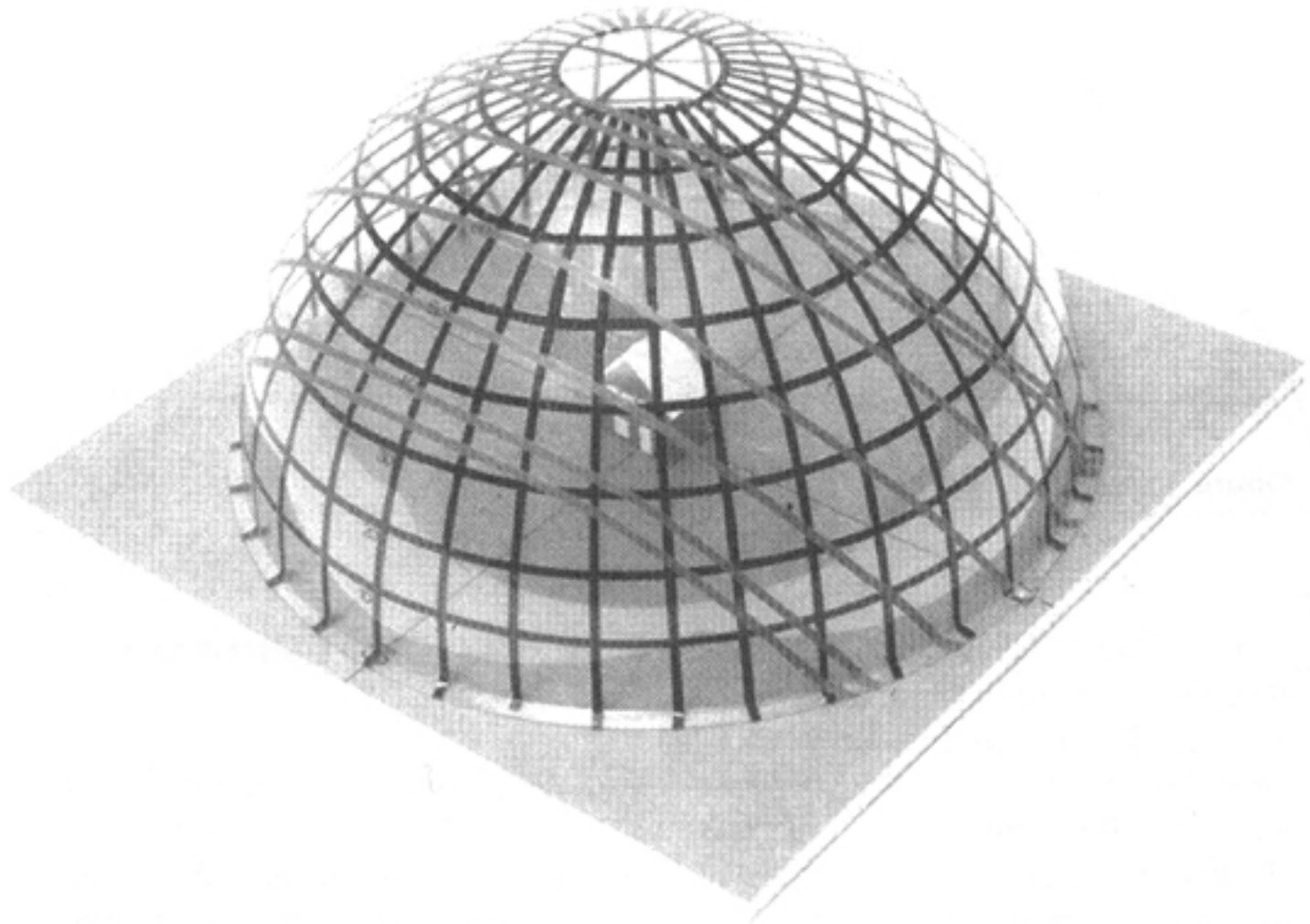
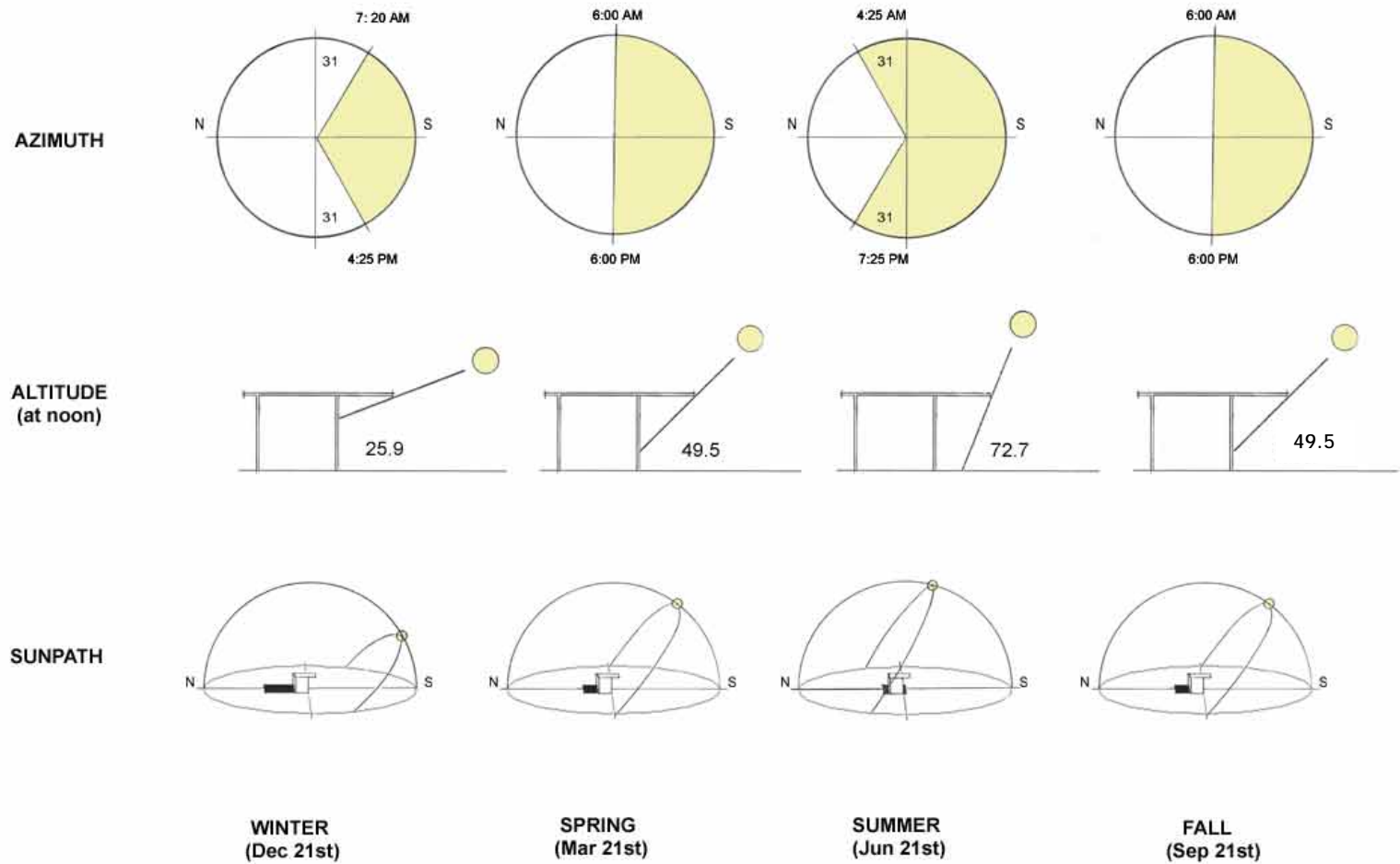
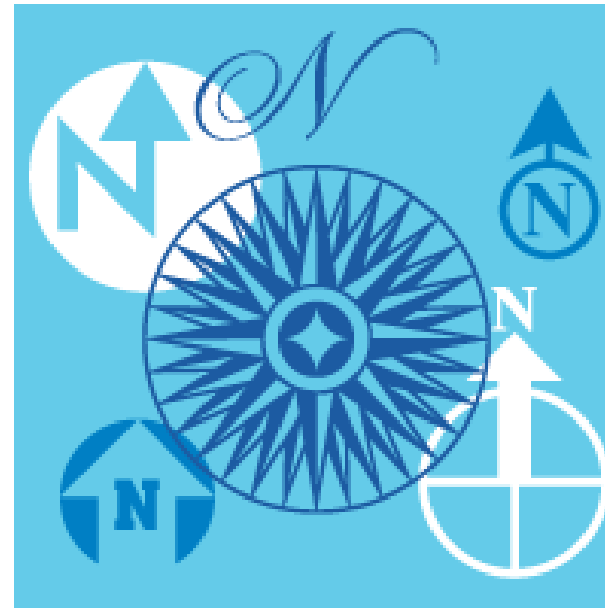
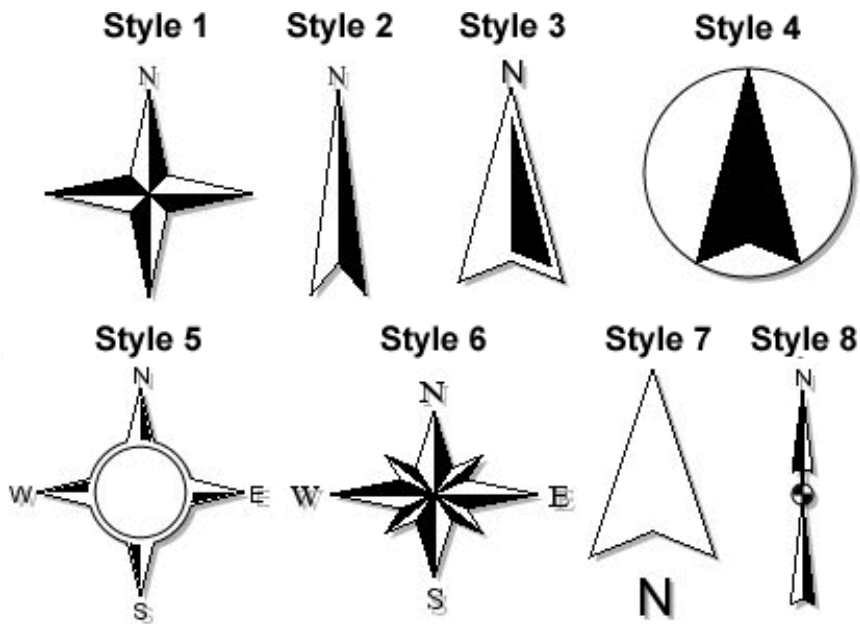

Figure 6.11b A model of the sky dome. The sun paths for the 21st day of each month are shown. Only seven paths are needed for twelve months because of symmetry (i.e., May 21 is the same path as July 21).



Matera Long: 16.35E Lat: 40.40N
<http://aa.usno.navy.mil/data/docs/AltAz.html>

You should be able to construct this set of diagrams for *any site* you are working on.



Designing for solar conditions requires that you are aware of the orientation of the site. If you don't have one of these on your plan *from the beginning*, then, you are not aware.

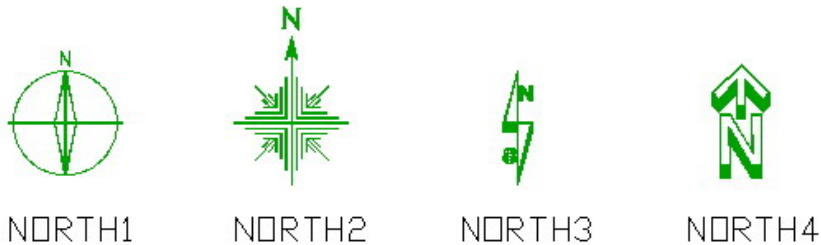

Sun Path Diagrams

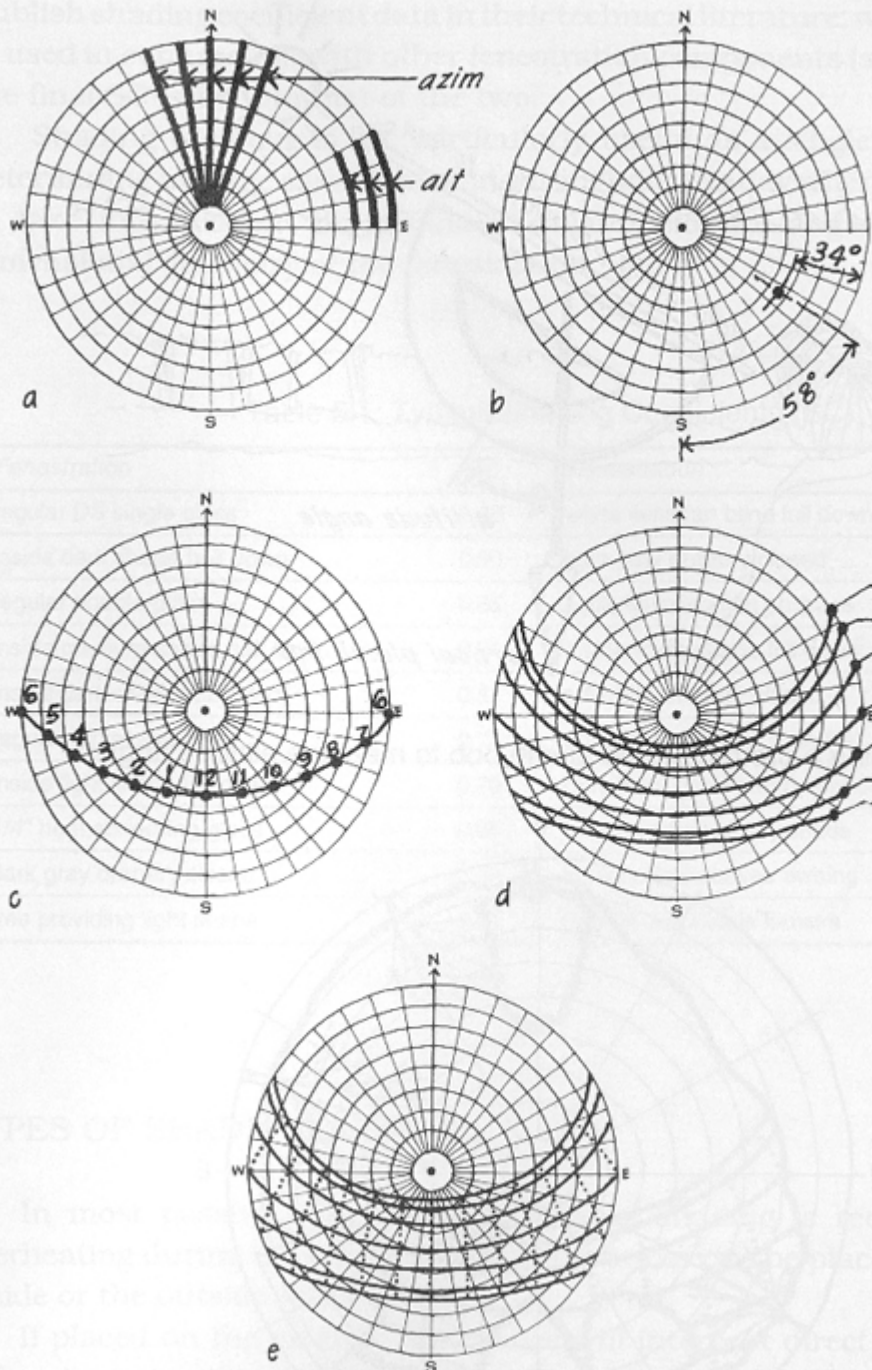

These are "aerial plan views" of the skydome.

Notice that the sun is symmetrical about the solstices, so we get the same lines for the spring and fall months.

Horizontal Projection Sun Path Diagram

Example: Find the altitude and azimuth of the sun in Memphis, Tennessee, on February 21 at 9 A.M.

Step 1. From a map of the United States, find the latitude of Memphis. Since it is at about 35 degrees latitude, use the sun-path diagram for 36 degrees north latitude (found in Appendix A and Fig. 6.11c).

Step 2. On this sun-path diagram, find the intersection of the sun path for February 21 (curve II) and the 9 A.M. line. This represents the location of the sun. The intersection is circled in Fig. 6.11c.

Step 3. From the concentric circles, the altitude is found to be about 27 degrees.

Step 4. From the radial lines, the azimuth is found to be about 51 degrees east of south.

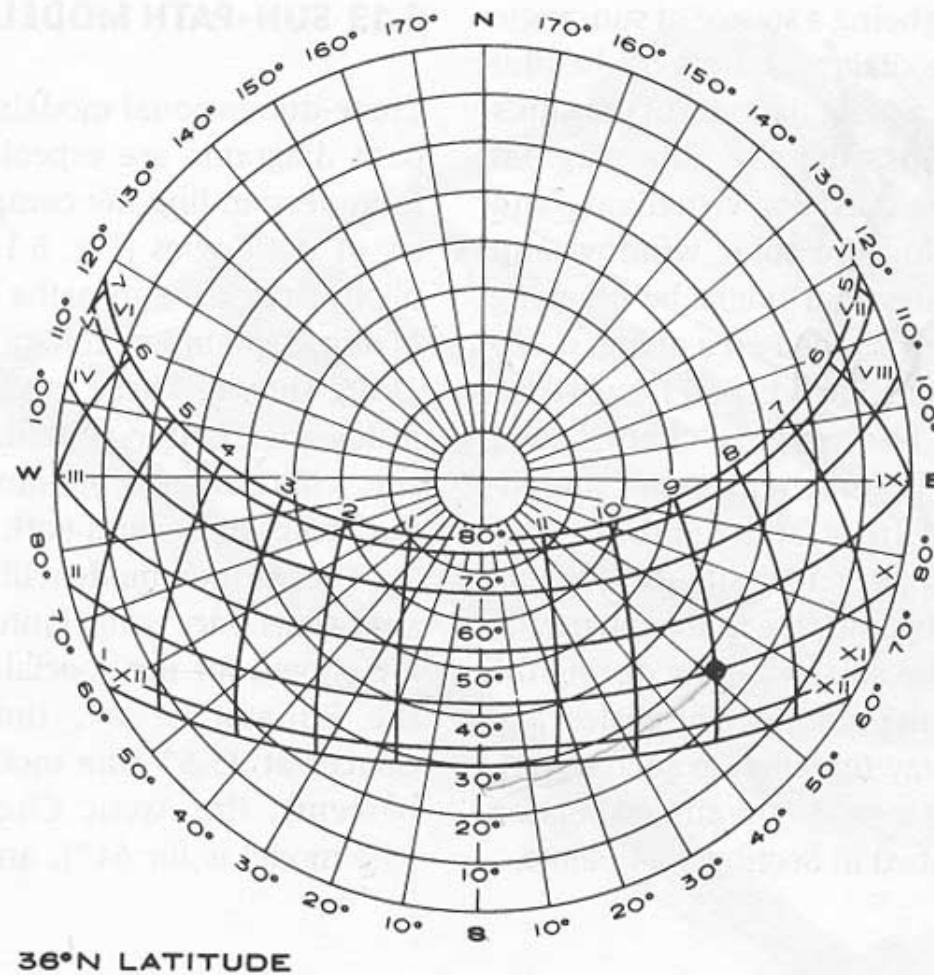

SWL

These diagrams always use “solar noon” as 12:00. You need to look at the local time conditions to see how this aligns to the actual time.

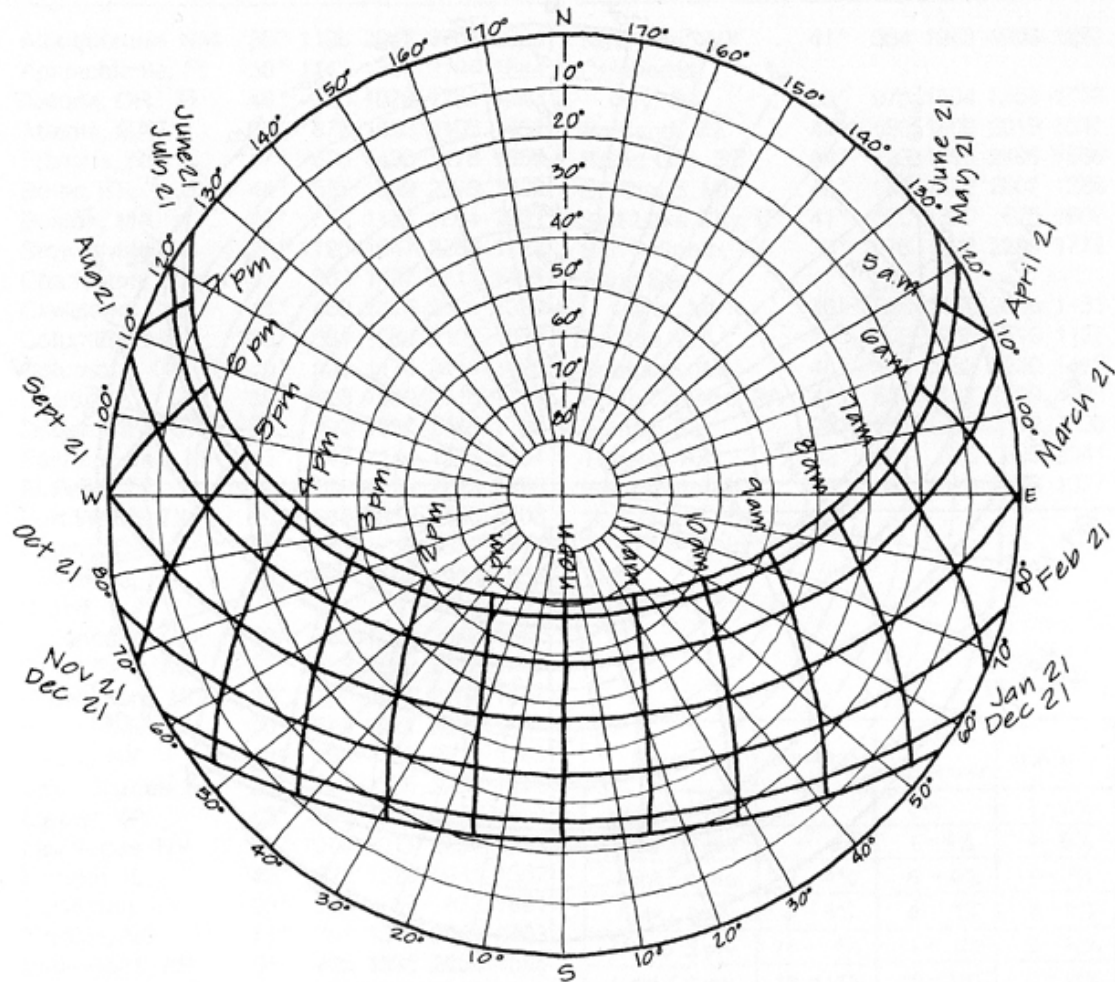

Sun Path Diagram 44° North Latitude



Toronto Latitude: 43° 40' North

Kitchener Latitude: 43° 27' North

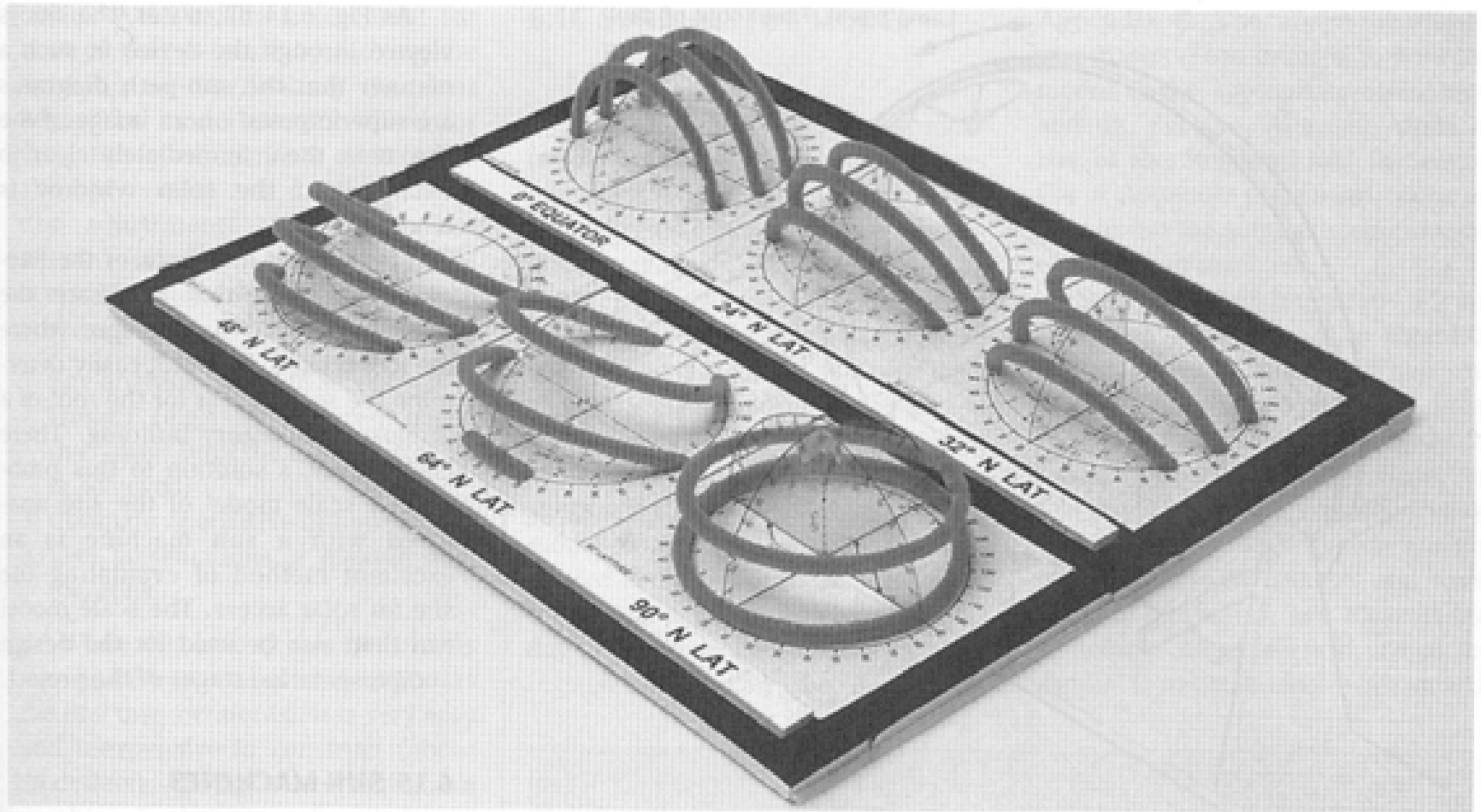

Figure 6.13 A comparison of various sun-path models. Note especially the sun paths for the Equator, Tropic of Cancer, Arctic Circle, and North Pole.

Vertical Projection Sun Path Diagram

Example: Find the altitude and azimuth of a sun ray in Albuquerque, New Mexico, on March 21 at 3 P.M.

Step 1. From Appendix B, choose the sun-path diagram that is within 2 degrees of the place in question. Since Albuquerque is at 35°N latitude, use the sun path for 36°N.

Step 2. Find the intersection of the curves for March 21 and 3 P.M. (see circle in Fig. 6.12a).

Step 3. From the horizontal scale, the azimuth is found to be about 59° west of south.

Step 4. From the vertical scale, the altitude is found to be about 34° above the horizontal.

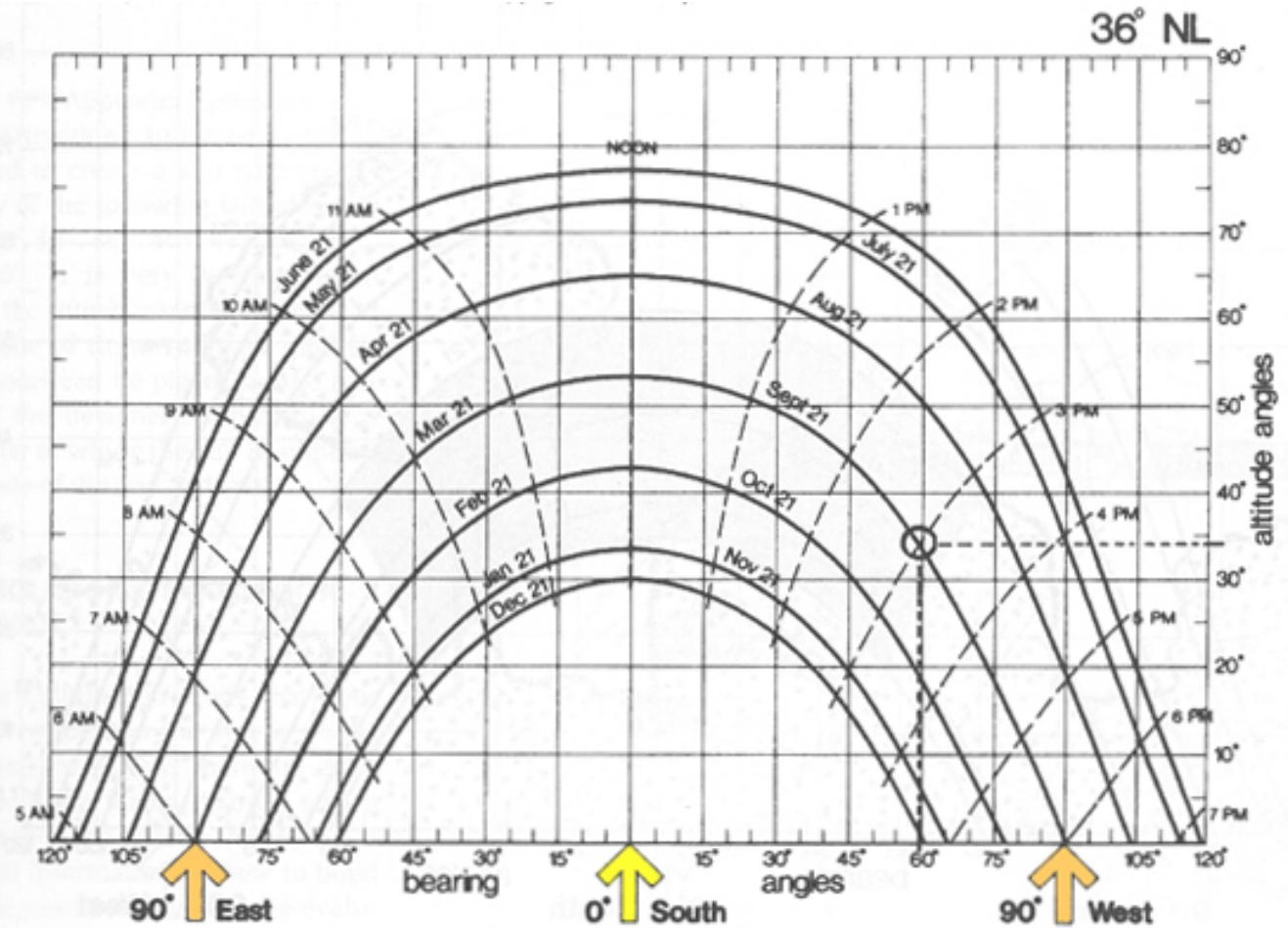

Figure 6.12a Vertical sun path diagram. A complete set of these diagrams is found in Appendix B. (Reprinted from *The Passive Solar Energy Book*, copyright E. Mazria, 1979, by permission.)

We use this tool to understand how surrounding buildings and trees will shade our site at various times of the year.

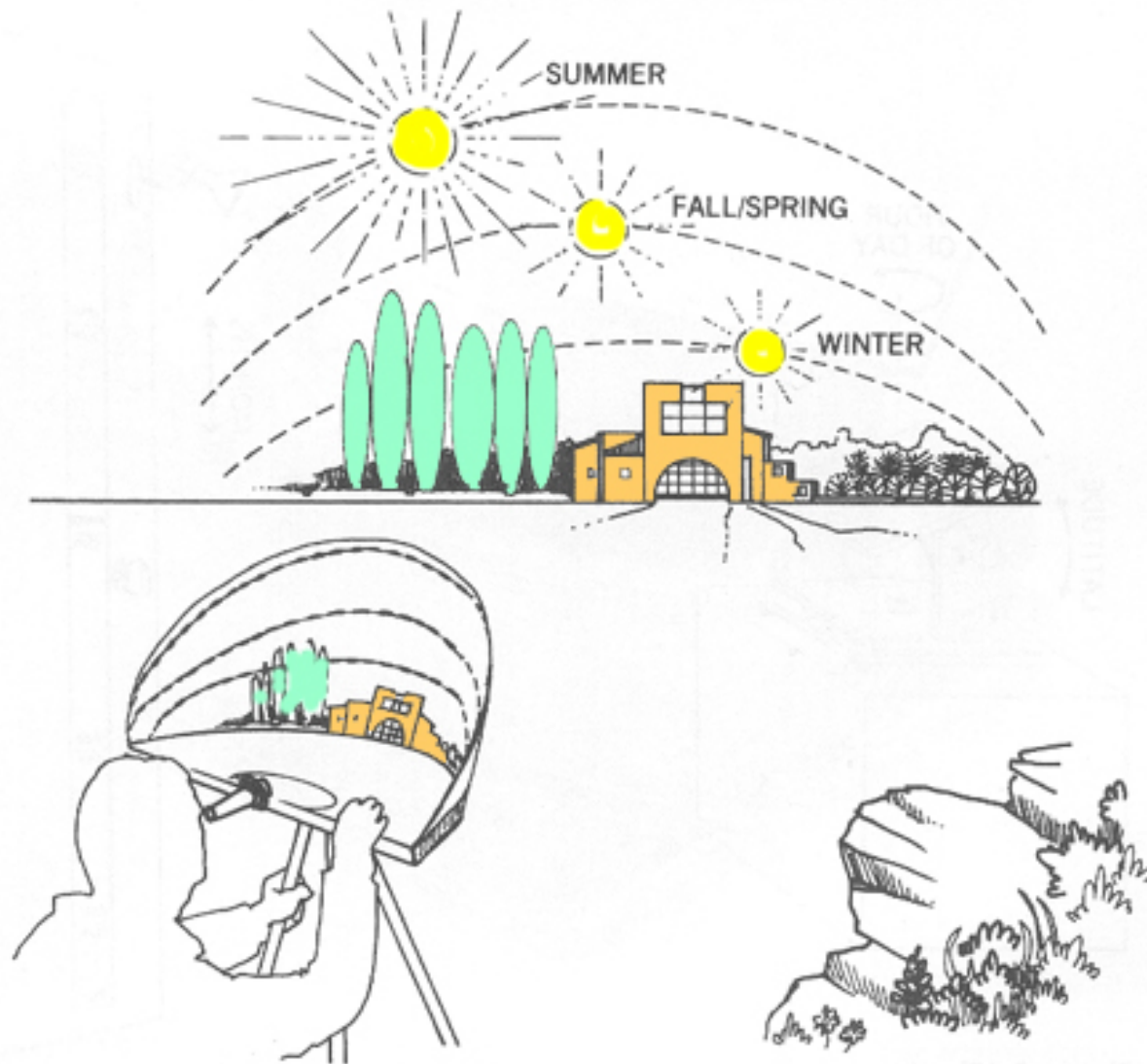

Figure 6.14 The sun-path diagram used as part of a solar site-evaluation tool.

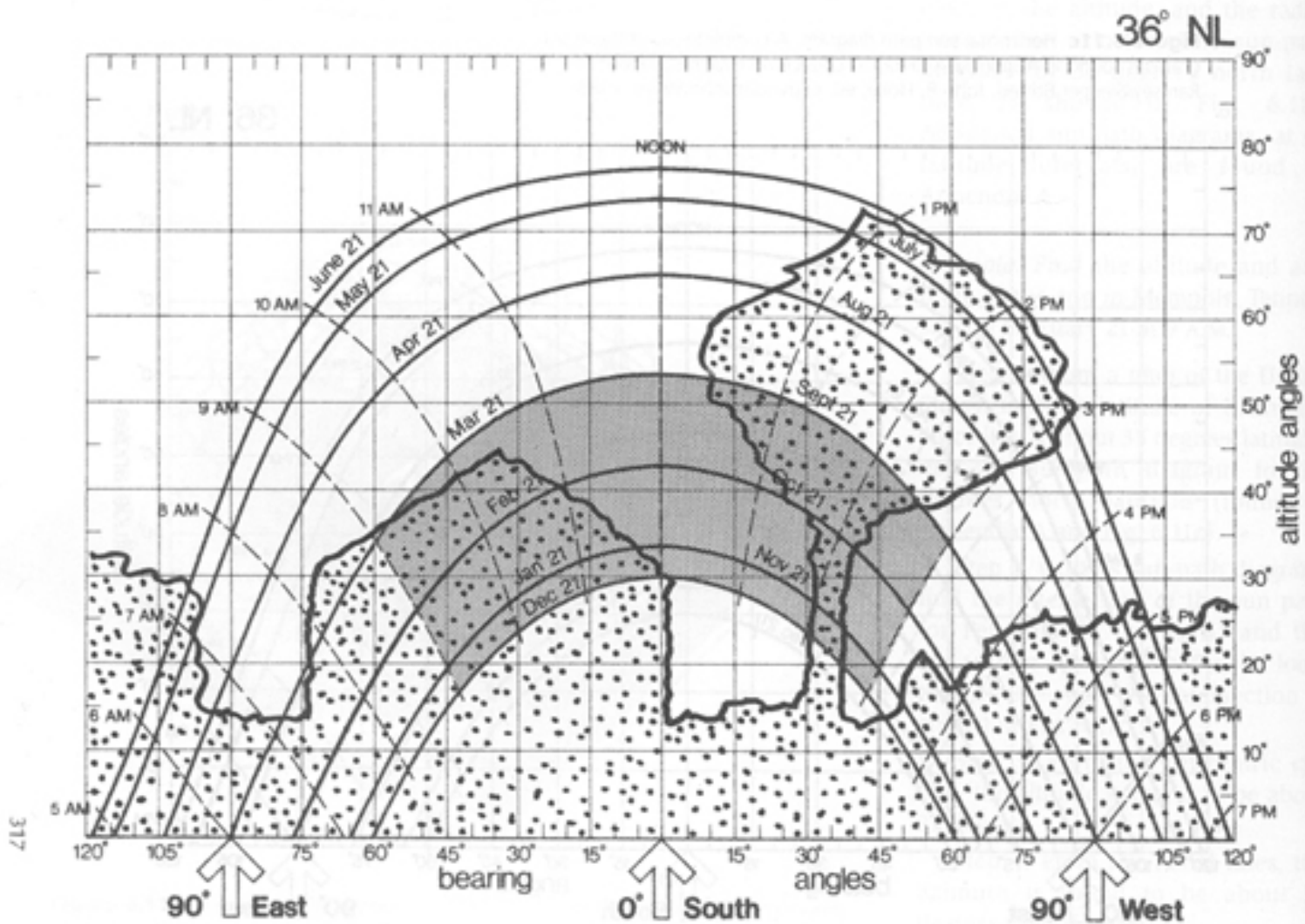

Figure 6.12b The winter solar window and silhouette of surrounding objects are shown on this vertical sun path diagram. The silhouette of a specific location was hand-drawn by means of a site-evaluator tool described in Section 6.14. (Sun path diagram from *The Passive Solar Energy Book*, copyright E. Mazria, 1979, reprinted by permission.)

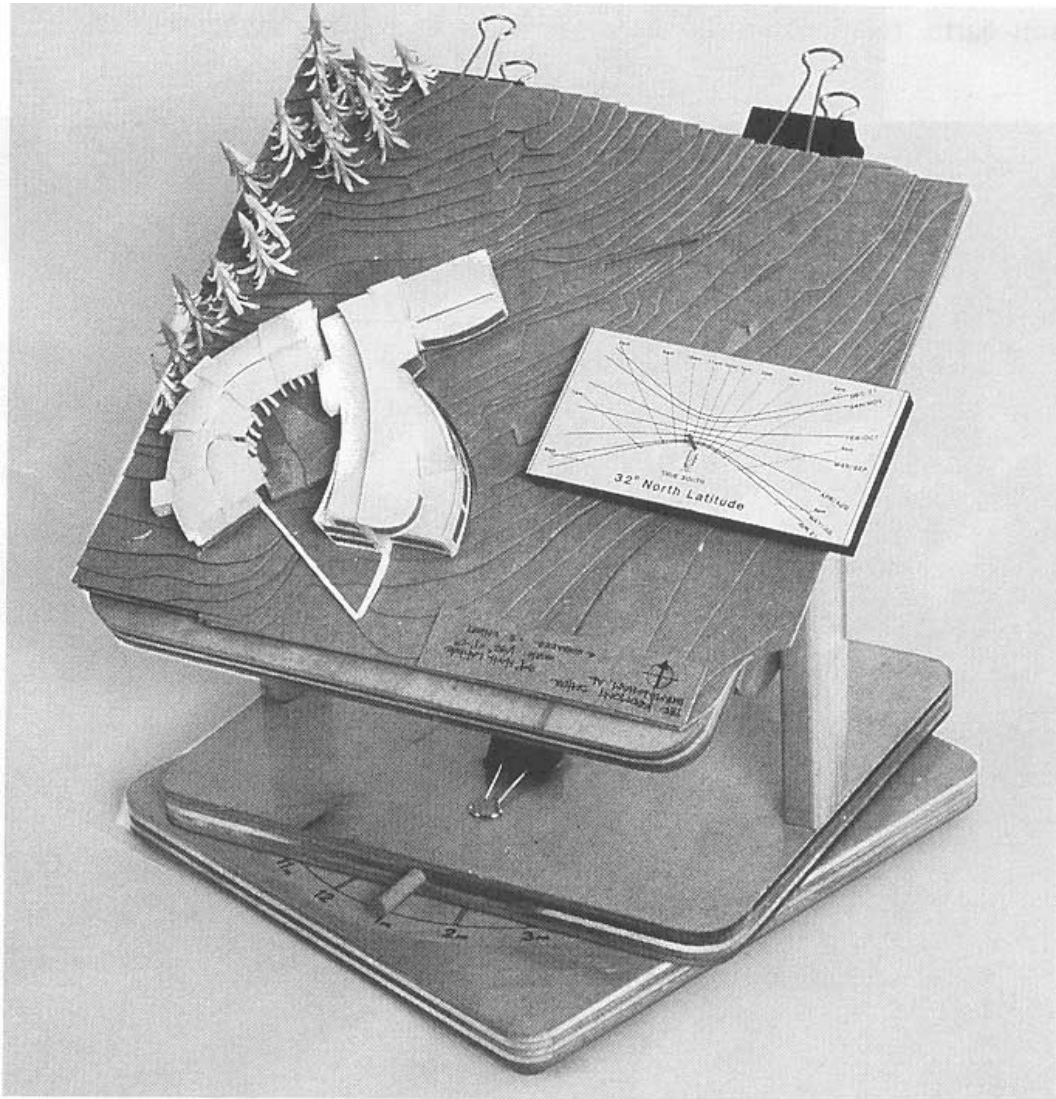

Figure 6.16 Sundials can be used to test models either under sunlight or an artificial light source.

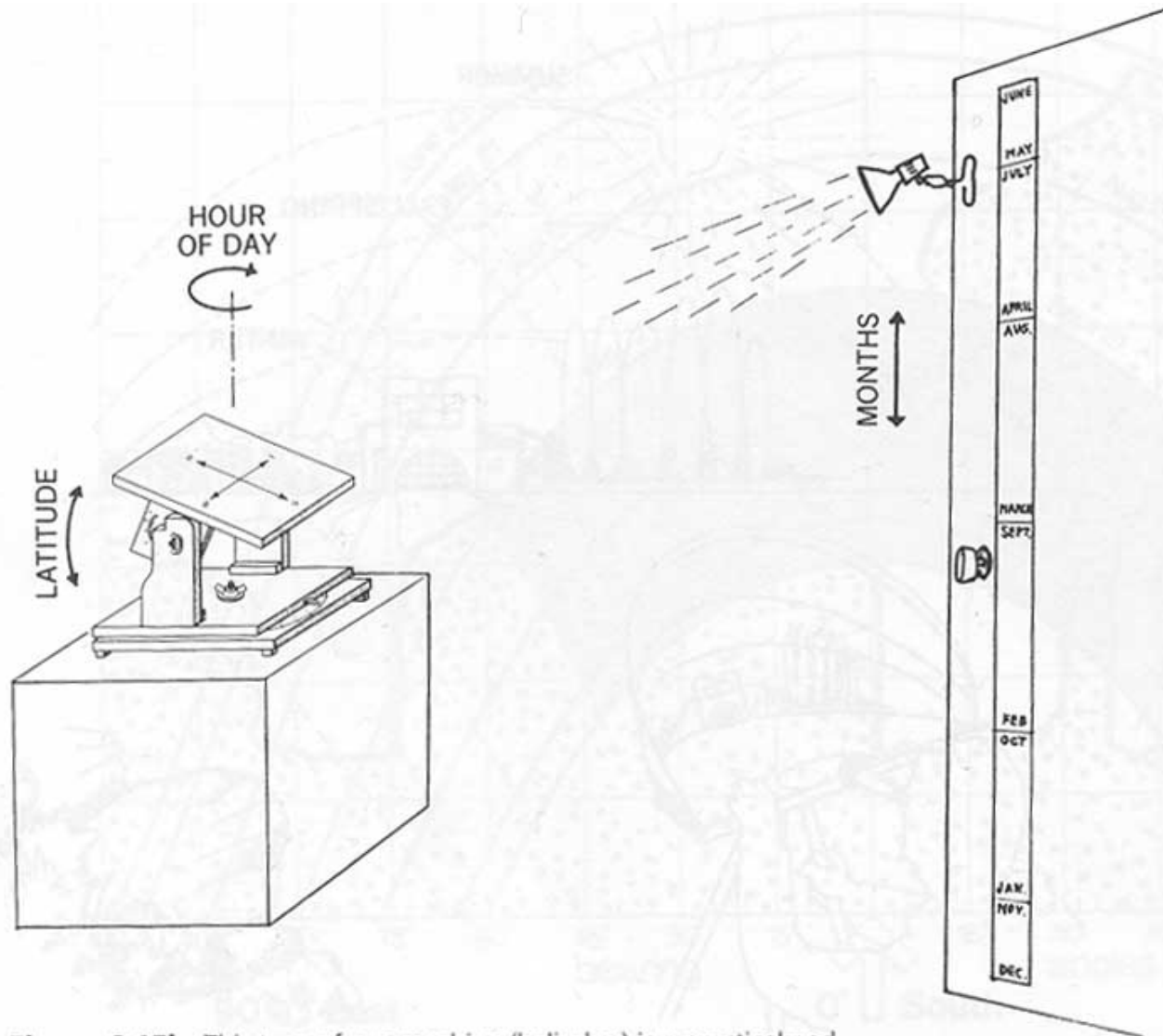
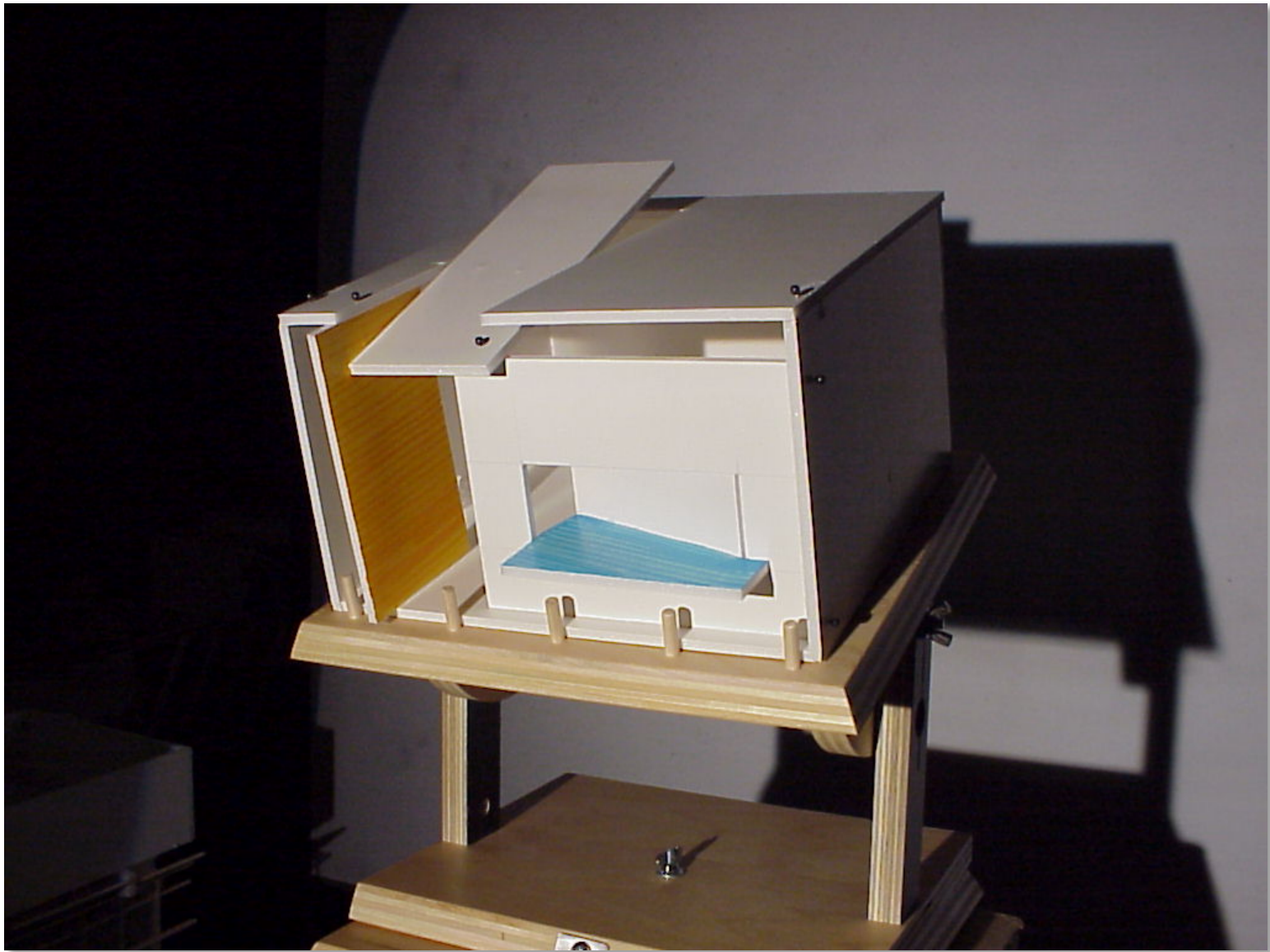
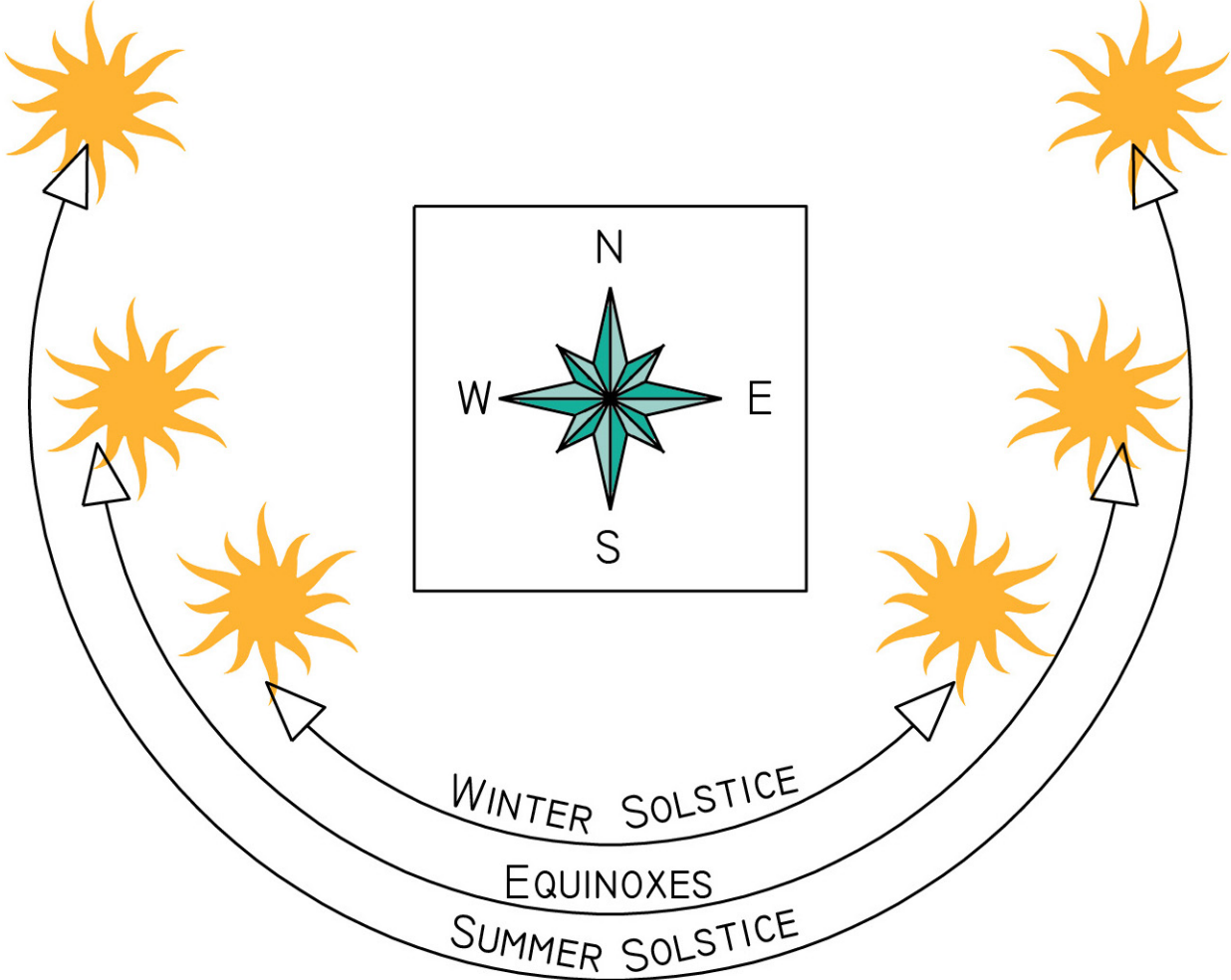

Figure 6.15b This type of sun machine (heliodon) is a practical and appropriate tool for every design studio.





SOLAR AZIMUTH RANGE THROUGHOUT THE YEAR



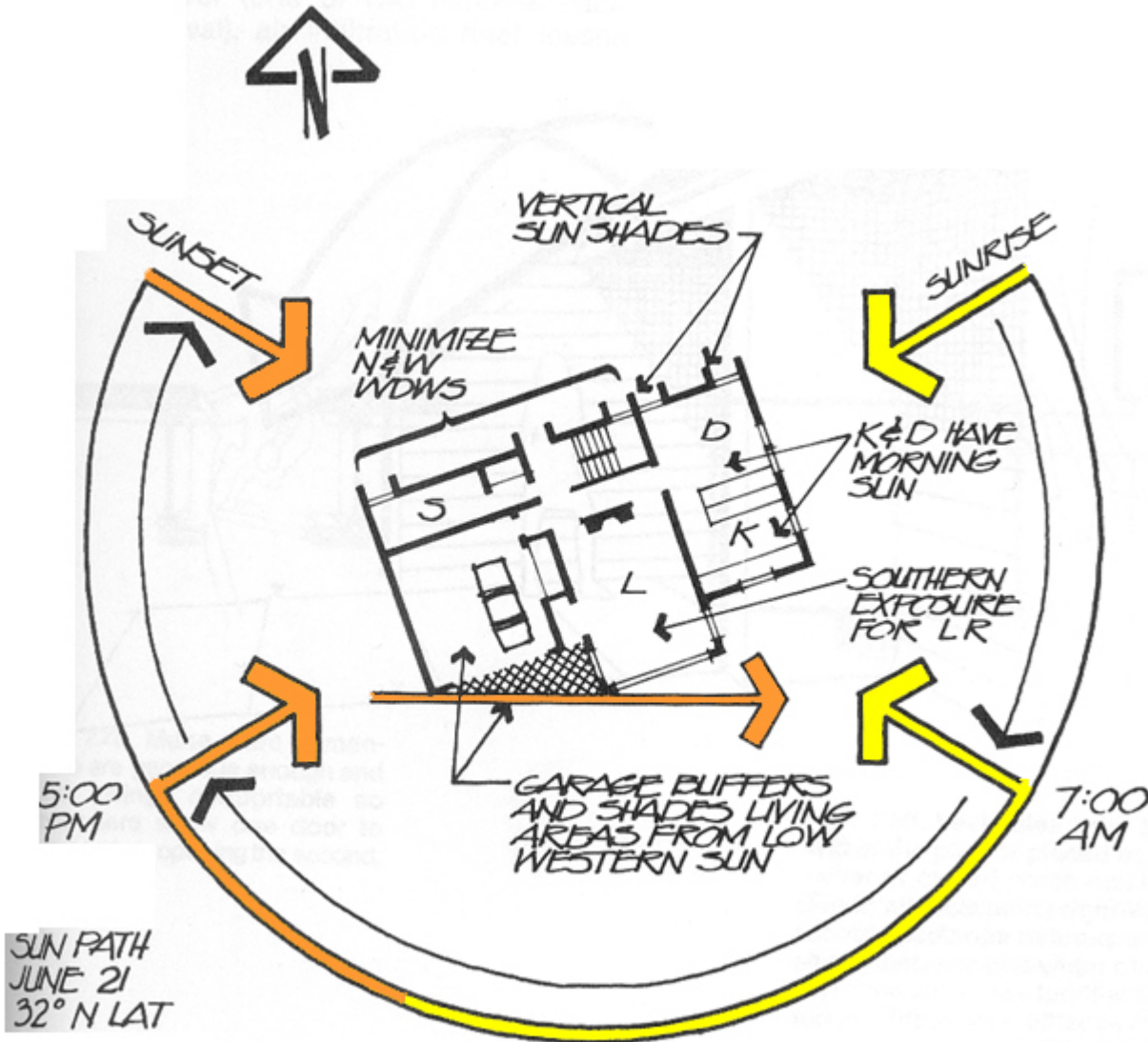
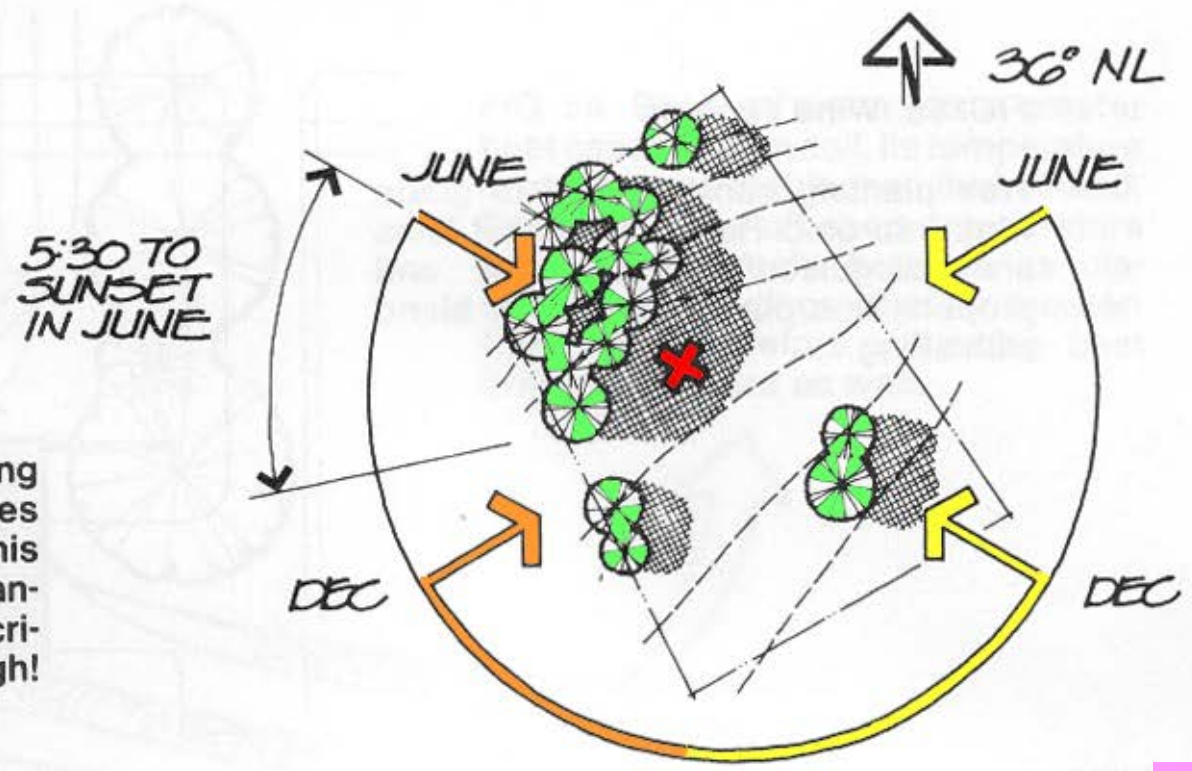

FIG. 21a

We begin to make key layout decisions based upon exposure to sun for heat and light.

We begin to make key layout decisions based upon exposure to sun for heat and light.

FIG. 4a "X" marks the spot for existing on-site sun protection. Look for sites shrouded by trees on west side. In this example, trees are on upslope, enhancing their shading ability. Don't sacrifice winter southern exposure, though!



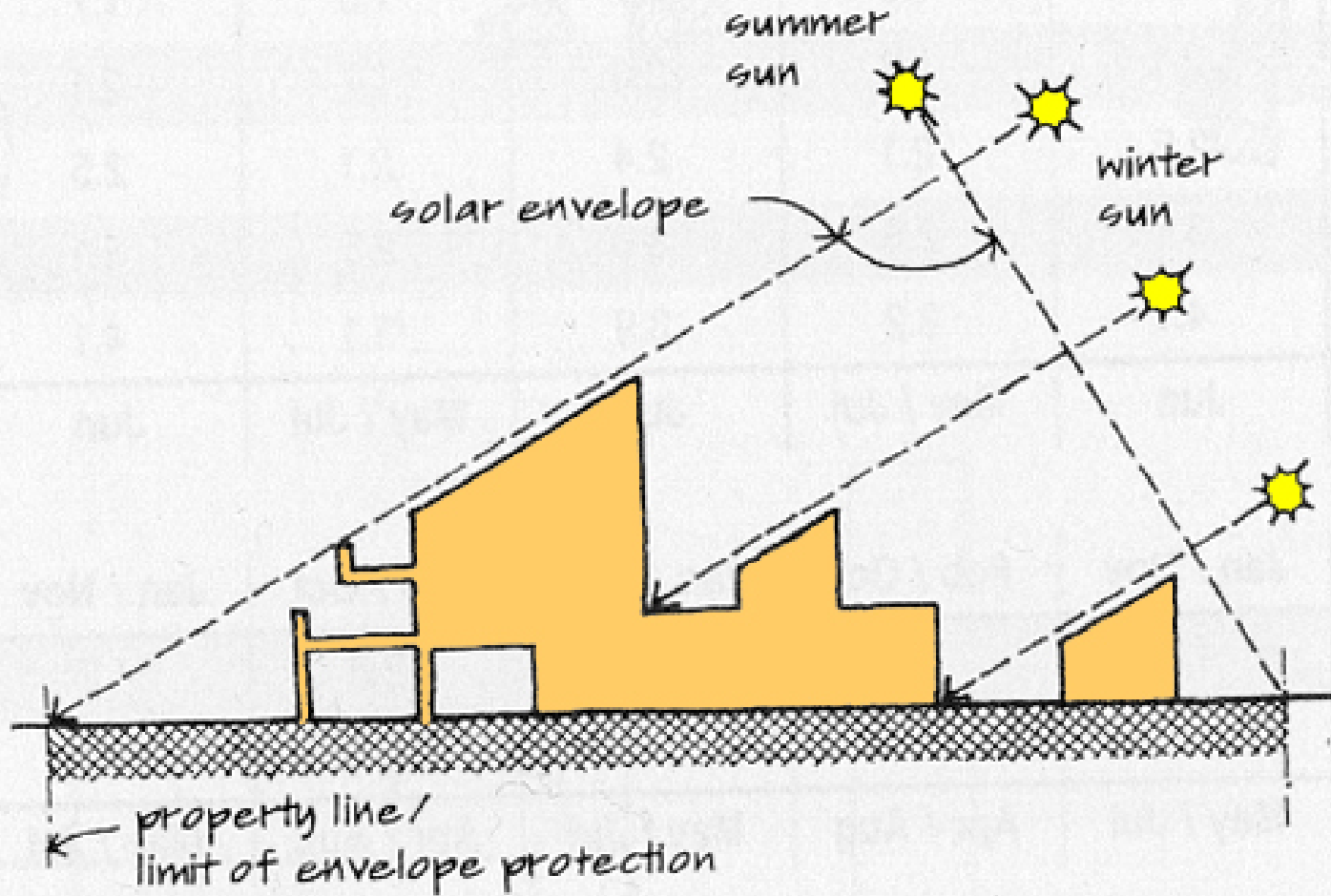

Solar Collection Within the Solar Envelope

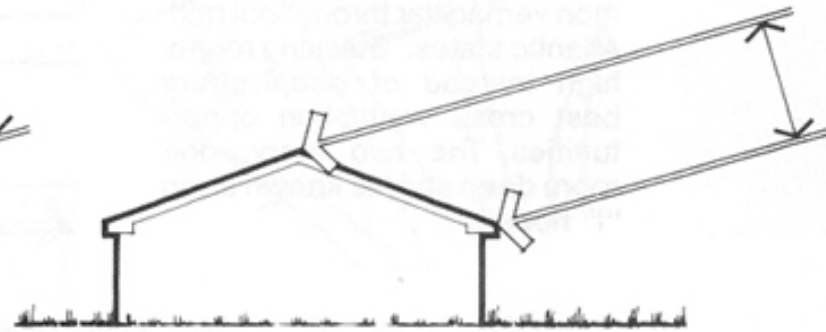
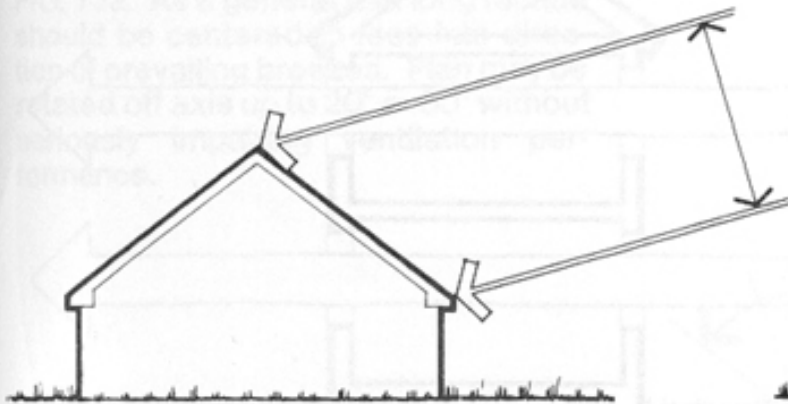
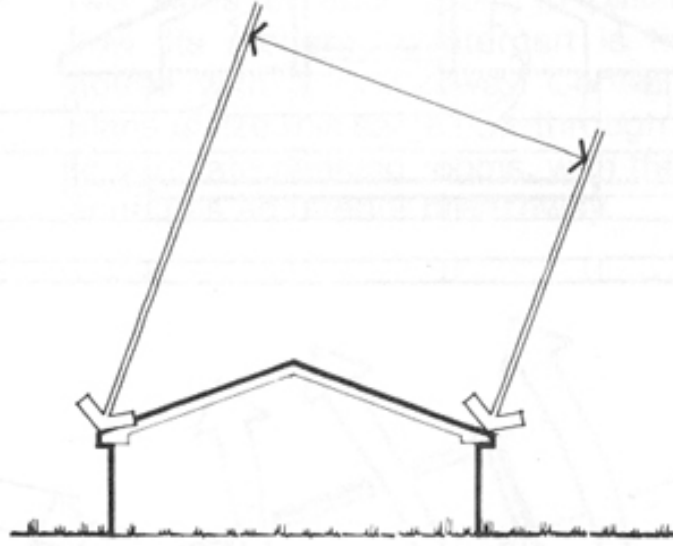
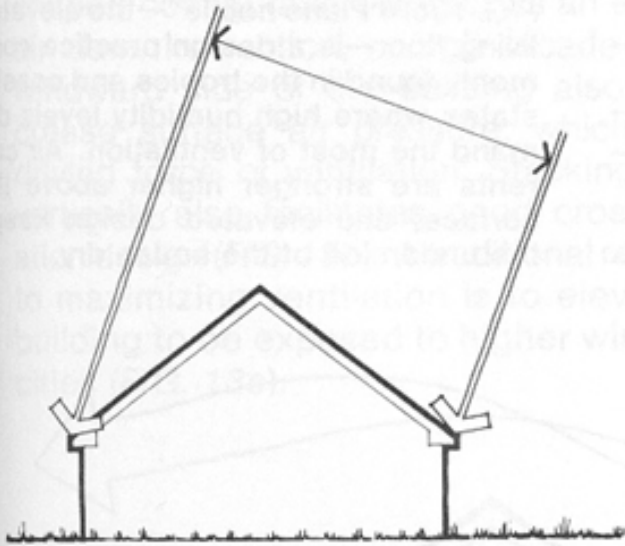

FIG. 12c. Roof shape has little effect on mid-day gain when sun is high.

Arch 126: Environmental Building Design

SOLAR SHADING



Shading is a key strategy of achieving thermal comfort in the summer months.

The tiered approach to reducing carbon for **COOLING**:

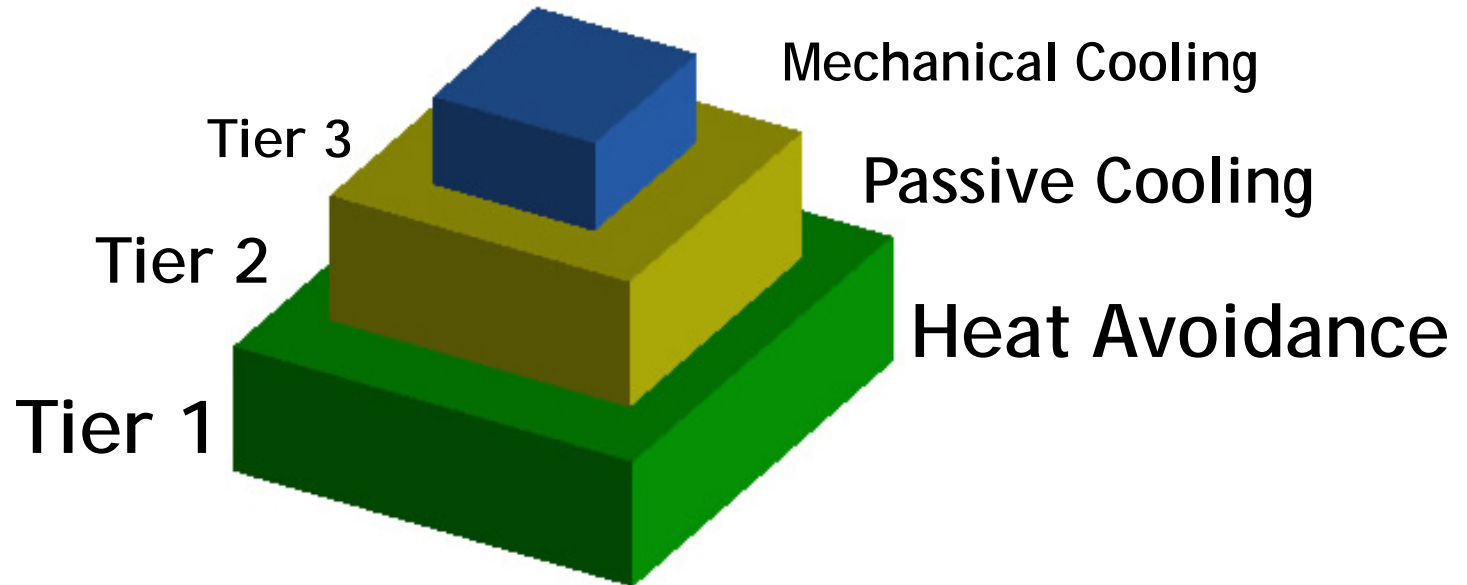

Maximize the amount of energy required for mechanical cooling that comes from renewable sources.

Source: Lechner. Heating, Cooling, Lighting.

Two main methods of preventing overheating:

1. Prevent the sun from hitting the glass: done using roof overhangs, special shading devices or vegetation.

OR

2. Use special glazing -- "spectrally selective" -- that filters the harmful rays out of the sunlight striking the glass.

Which orientations get how much??

-A horizontal window (skylight) receives 4 to 5 times more solar radiation than south window on June 21.

-East and West glazing collects almost 3 times the solar radiation of south window.

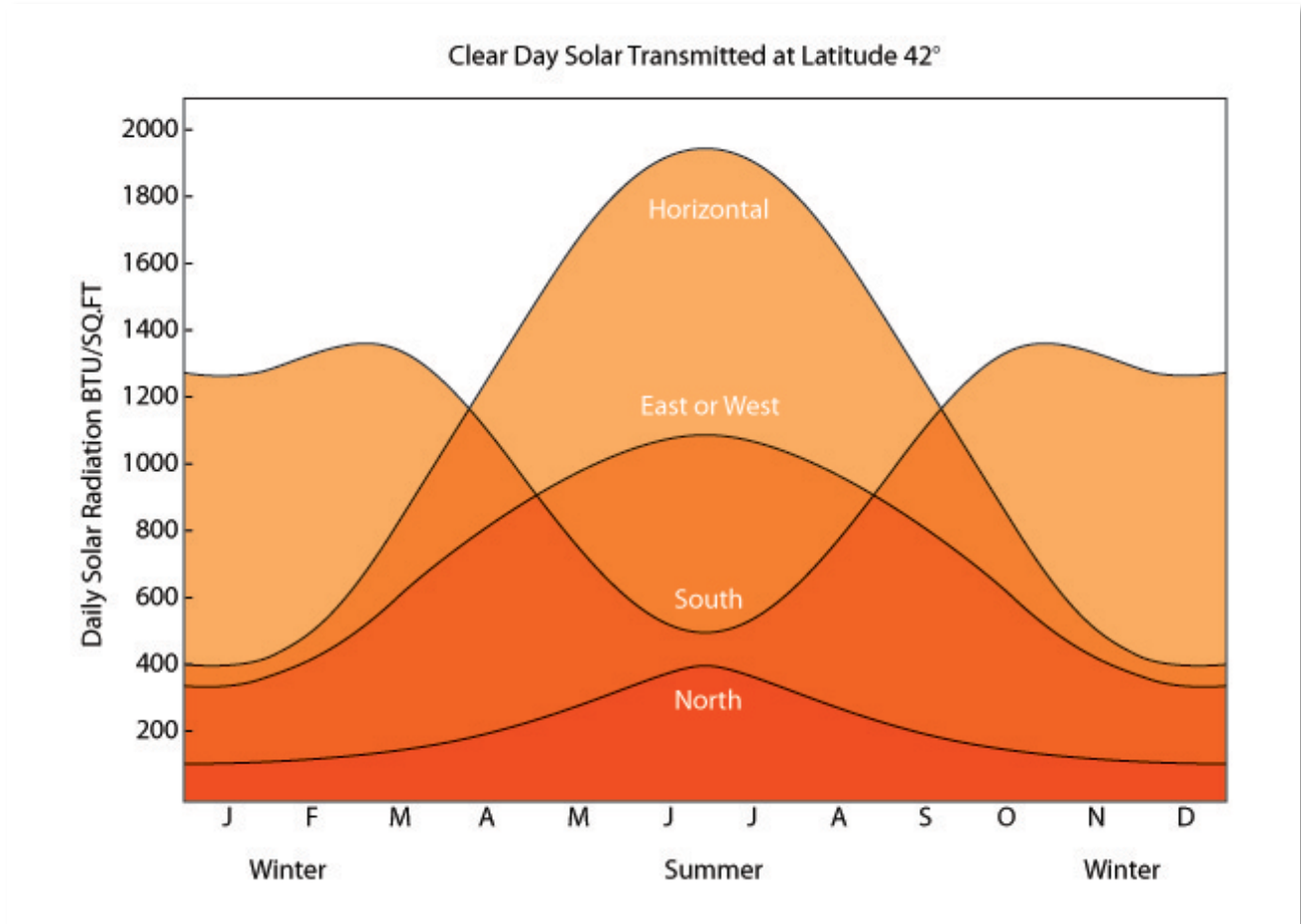

The Function of Glazing

The larger the angle of incidence (steepness of the sun angle), the less transmittance.

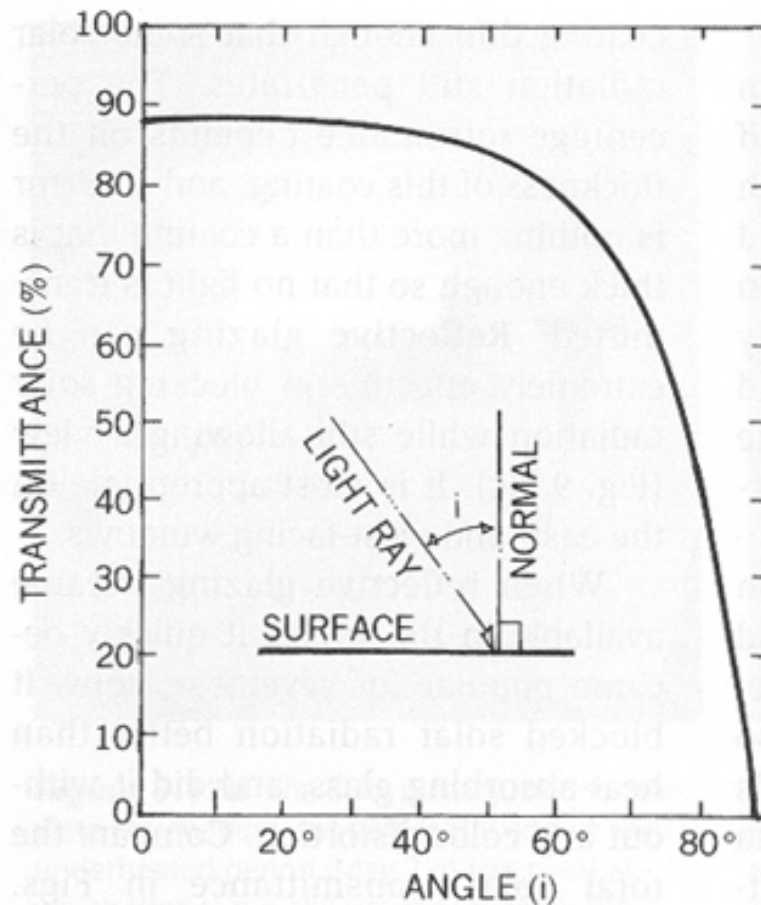
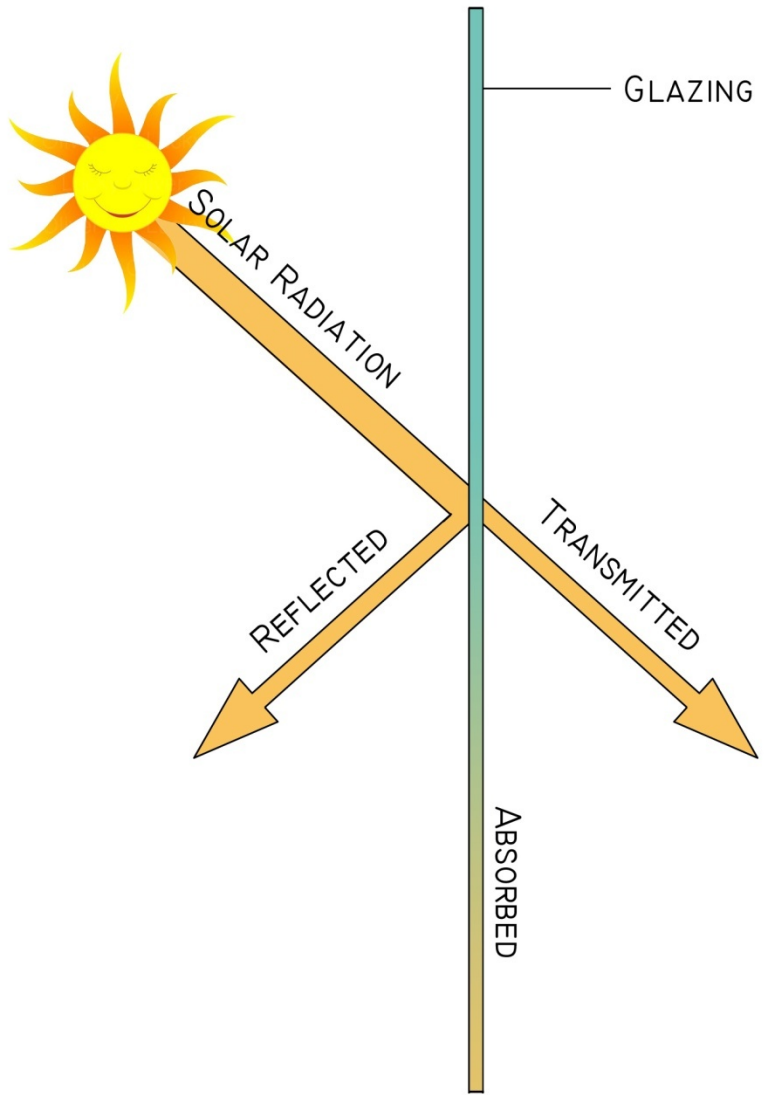
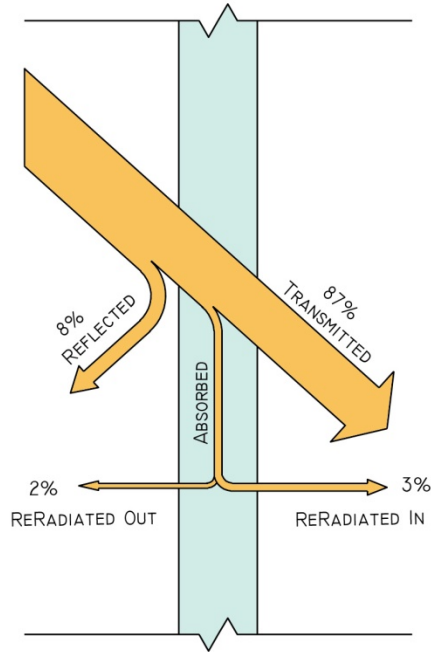

Figure 9.18d The transmittance of solar radiation through glazing is a function of the angle of incidence, which is always measured from the normal to the surface.



CLEAR GLASS



MOST OF THE INCIDENT SOLAR RADIATION IS:

TRANSMITTED

HEAT GAIN:



HEAT ABSORBING GLASS

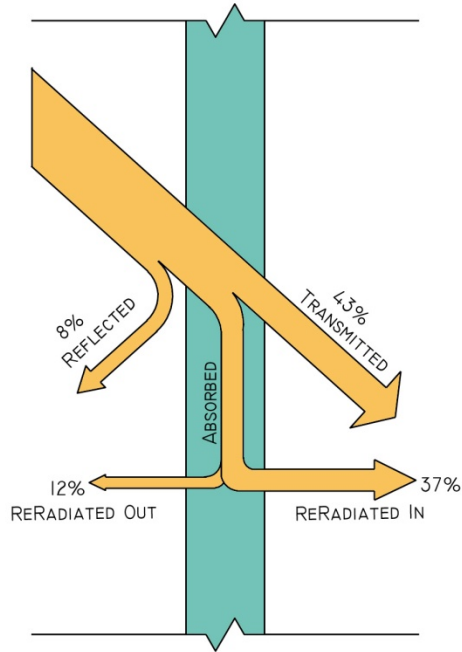

MOST OF THE INCIDENT SOLAR RADIATION IS:

TRANSMITTED + RERADIATED IN

HEAT GAIN:



REFLECTIVE GLASS

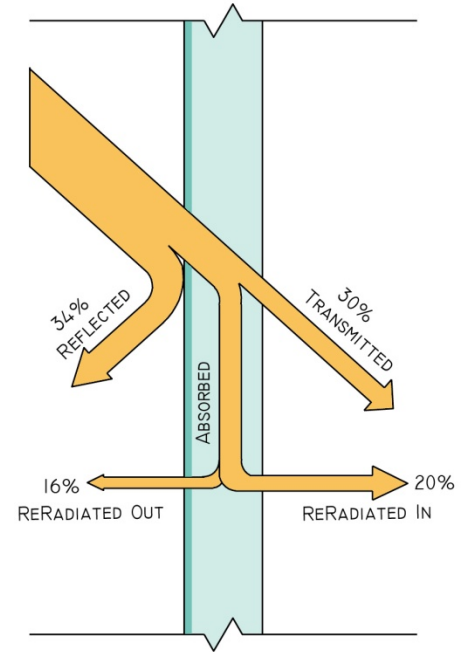

MOST OF THE INCIDENT SOLAR RADIATION IS:

REFLECTED

HEAT GAIN:



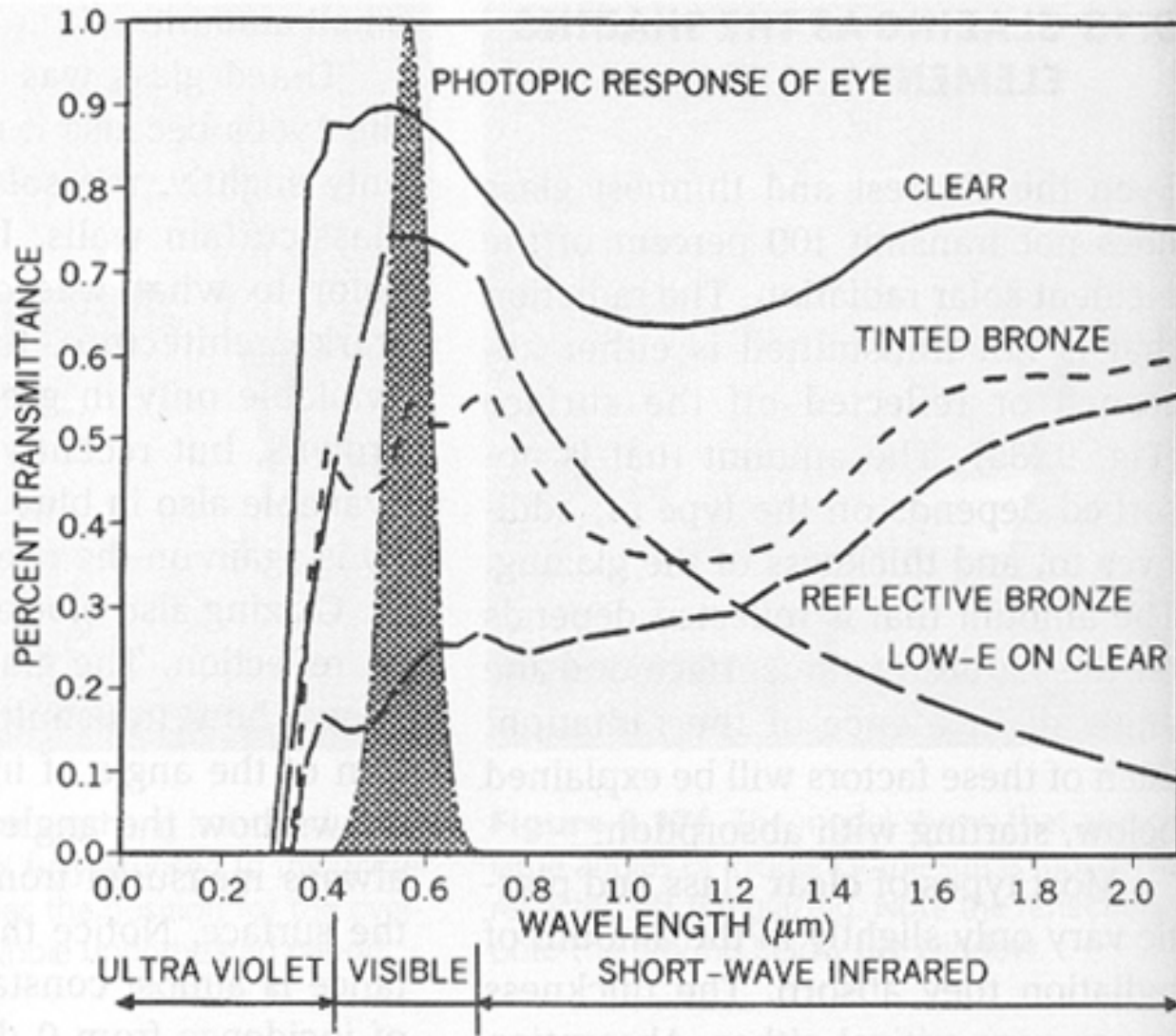
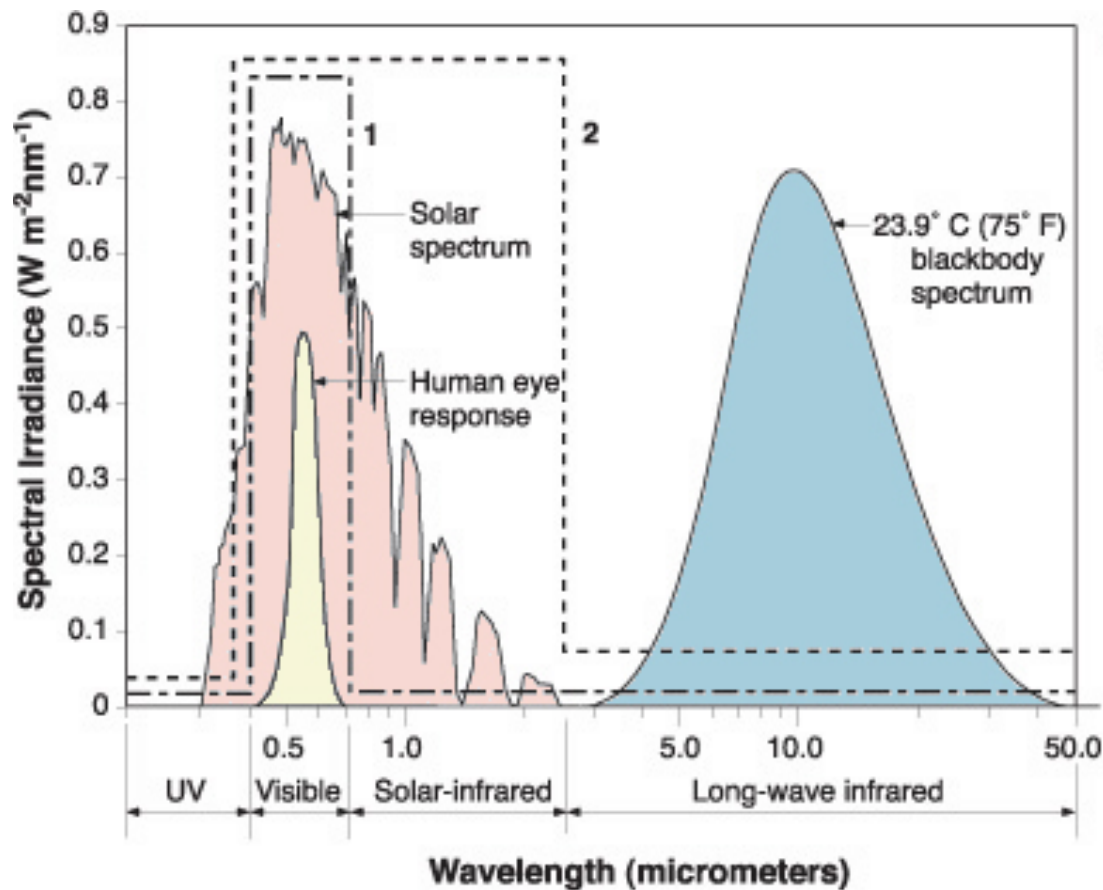

Figure 9.18f Spectrally selective low-e glazing transmits cooler daylight because it reflects the short-wave infrared much more than the visible radiation. (From "Effects of Low Emissivity Glazings on Energy Use Patterns," *ASHRAE Transactions*, Vol. 93, Pt. I 1989.)



Green on the Grand in Kitchener uses spectrally selective glazing and no shading devices to control heat gain.



1 --- Idealized transmittance of a glazing with a low-E coating designed for low solar heat gain. Visible light is transmitted and solar-infrared radiation is reflected. Long-wave infrared radiation is reflected back into the interior. This approach is suitable for commercial buildings in almost all climates.

2 --- Idealized transmittance of a glazing with a low-E coating designed for high solar heat gain. Visible light and solar-infrared radiation are transmitted. Long-wave infrared radiation is reflected back into the interior. This approach is more commonly used for residential windows in cold climates.

Note: As shown by the solar spectrum in the figure, sunlight is composed of electromagnetic radiation of many wavelengths, ranging from short-wave invisible ultraviolet to the visible spectrum to the longer, invisible solar-infrared waves.

Figure 2-3. Ideal spectral transmittance for glazings in different climates (Source: McCluney, 1996)

TABLE 9.20 SHADING COEFFICIENTS (SC) AND SOLAR HEAT GAIN COEFFICIENTS (SHGC) FOR VARIOUS SHADING DEVICES

Device	SC	SHGC
Single glazing		
Clear glass, 1/8-inch thick	1.0	0.86
Clear glass, 1/2-inch thick	0.94	0.81
Heat absorbing or tinted	0.6–0.8	0.5–0.7
Reflective	0.2–0.5	0.2–0.4
Double glazing		
Clear	0.84	0.73
Bronze	0.5–0.7	0.4–0.6
Low-e clear	0.6–0.8	0.5–0.7
Spectrally selective	0.4–0.5	0.3–0.4
Triple-clear	0.7–0.8	0.6–0.7
Glass Block	0.1–0.7	
Interior shading		
Venetian blinds	0.4–0.7	
Roller shades	0.2–0.6	
Curtains	0.4–0.8	
External shading		
Eggcrate	0.1–0.3	
Horizontal overhang	0.1–0.6	
Vertical fins	0.1–0.6	
Trees	0.2–0.6	

NOTES:

1. The smaller the number, the less solar radiation enters through a window. A value of zero indicates that the window allows no solar radiation to enter either directly or reradiated after being absorbed.
2. Ranges are given either because of the large variety of glazing types available (e.g., slightly or heavily tinted) or because of the varying geometry due to differences in orientation, sun angle, size and type of shading device, and variations in window size.
3. Source: ASHRAE Fundamentals Handbook 1997, Egan, 1975.

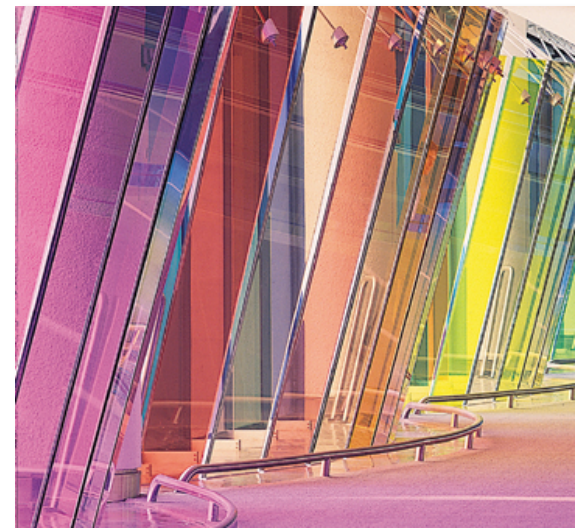

The Function of the Atmosphere

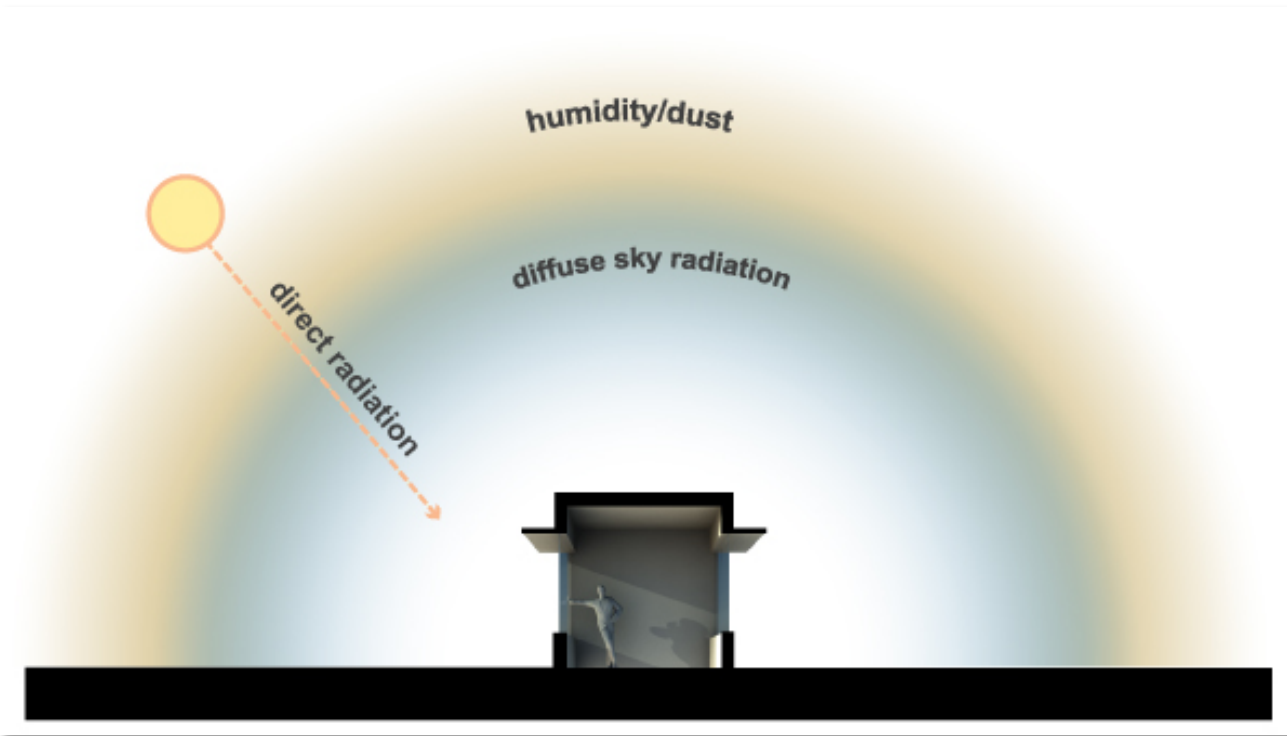
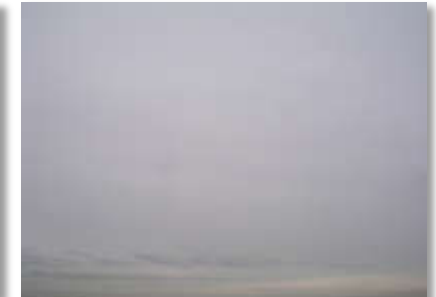

The precise condition of the sky is taken into account when determining the amount of solar radiation that is received by a building. *The clearer the sky, the more energy received.*

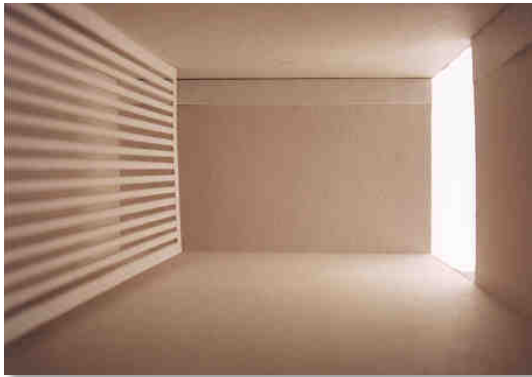

diffuse



direct

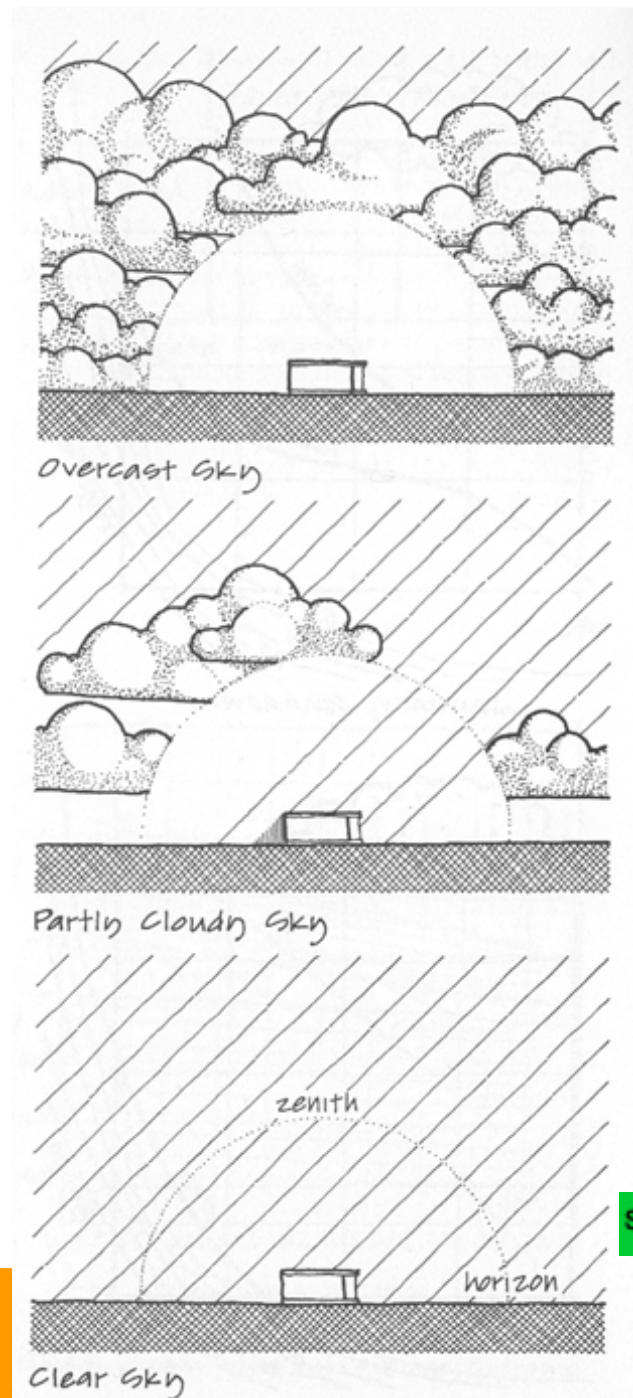

When it is cloudy the rays are diffused and even less radiation reaches the earth's surface. Shadows are less severe and light is more even.

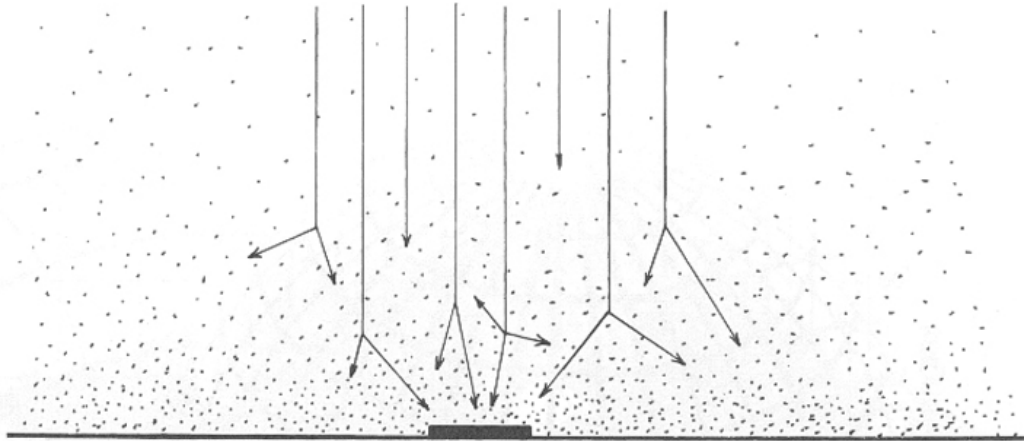

Figure 6.9b Diffuse radiation.

HCL



So even within the same space, the **microclimate** will change due to solar conditions from one day to the next.



The diffuse light on the cloudy day more evenly illuminates all faces of the building, leaving no faces in dark shadow.

The Disney Concert Hall in Los Angeles required remediation to its shiny skin as the curves were creating hot points in the adjacent streets that were dangerous to cars and pedestrians.

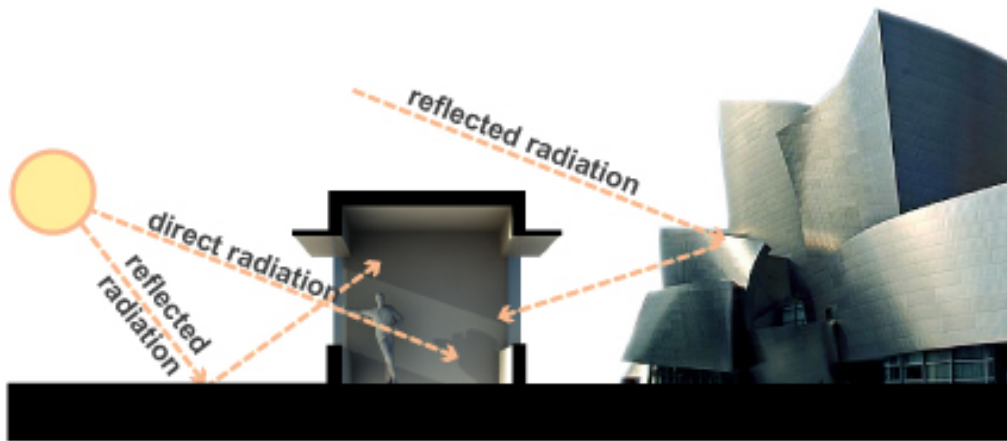

Reflective glazing



Rafael Vignoly's infamous "Walkie Scorchie" skyscraper in London, England

<http://www.theguardian.com/uk-news/video/2013/sep/03/london-walkie-talkie-skyscraper-video>

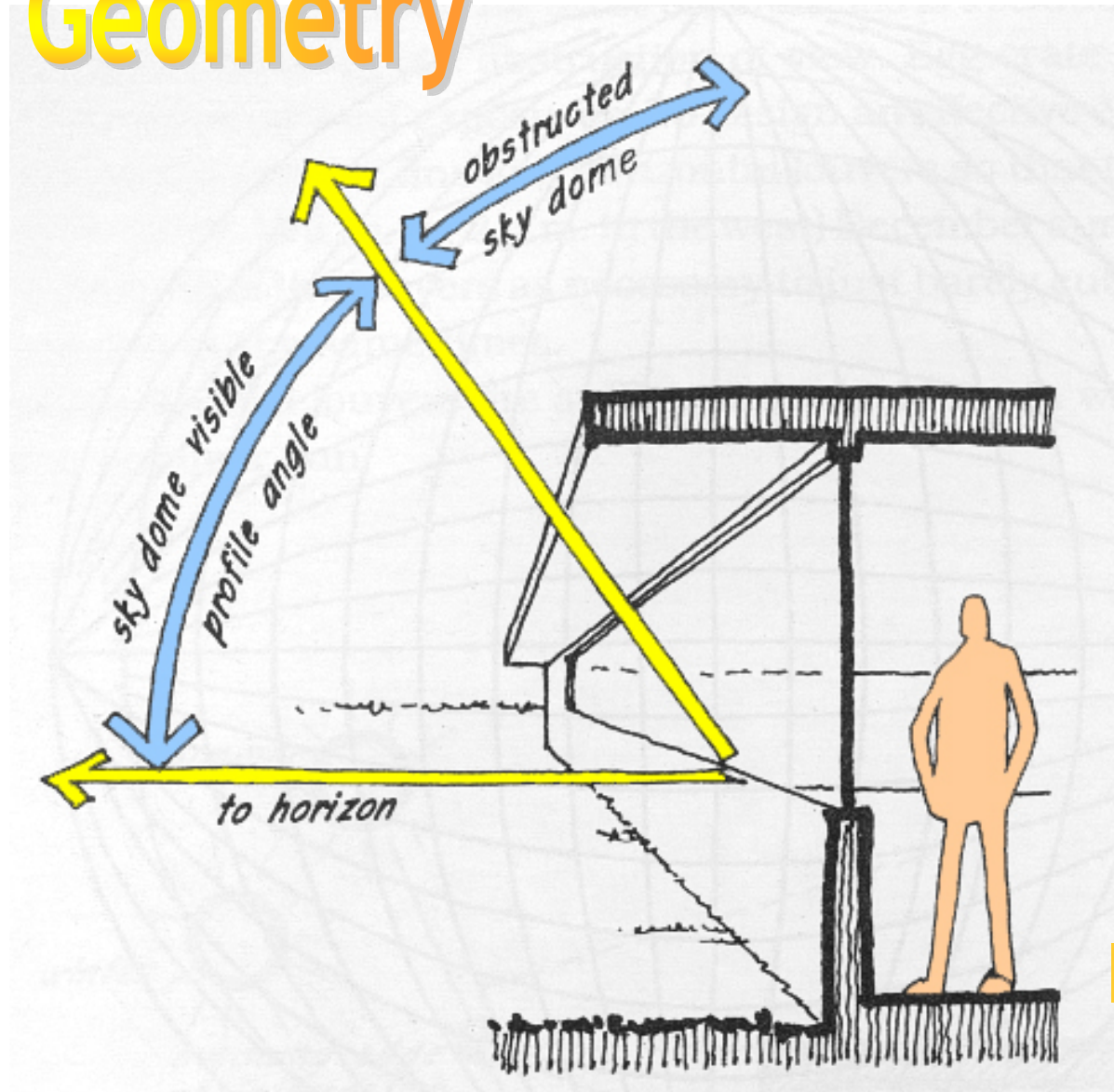

Image: Evelyn Hoffman

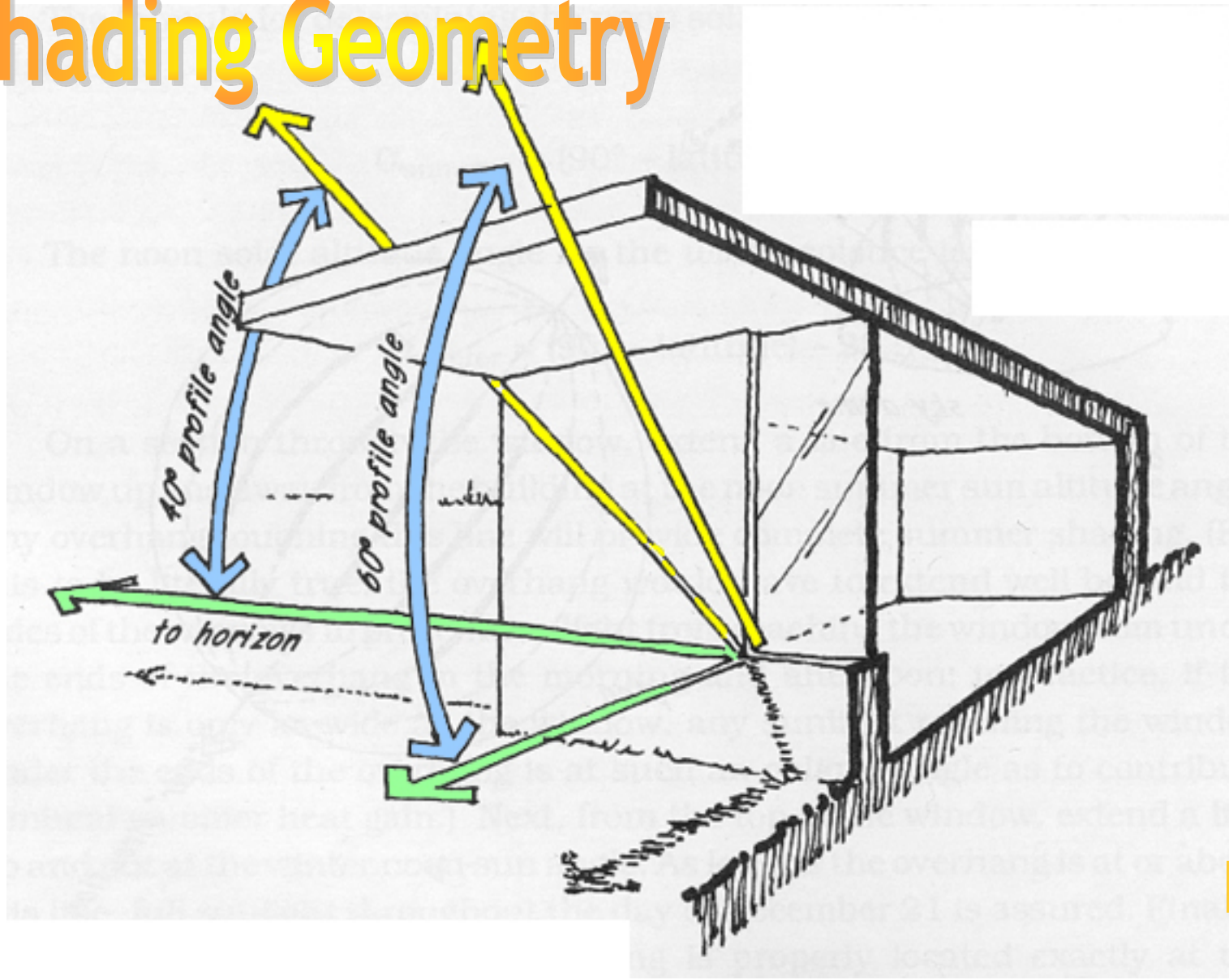

Image: Evelyn Hoffman

Shading Geometry



Shading Geometry



A simple roof overhang acts as a shading device.

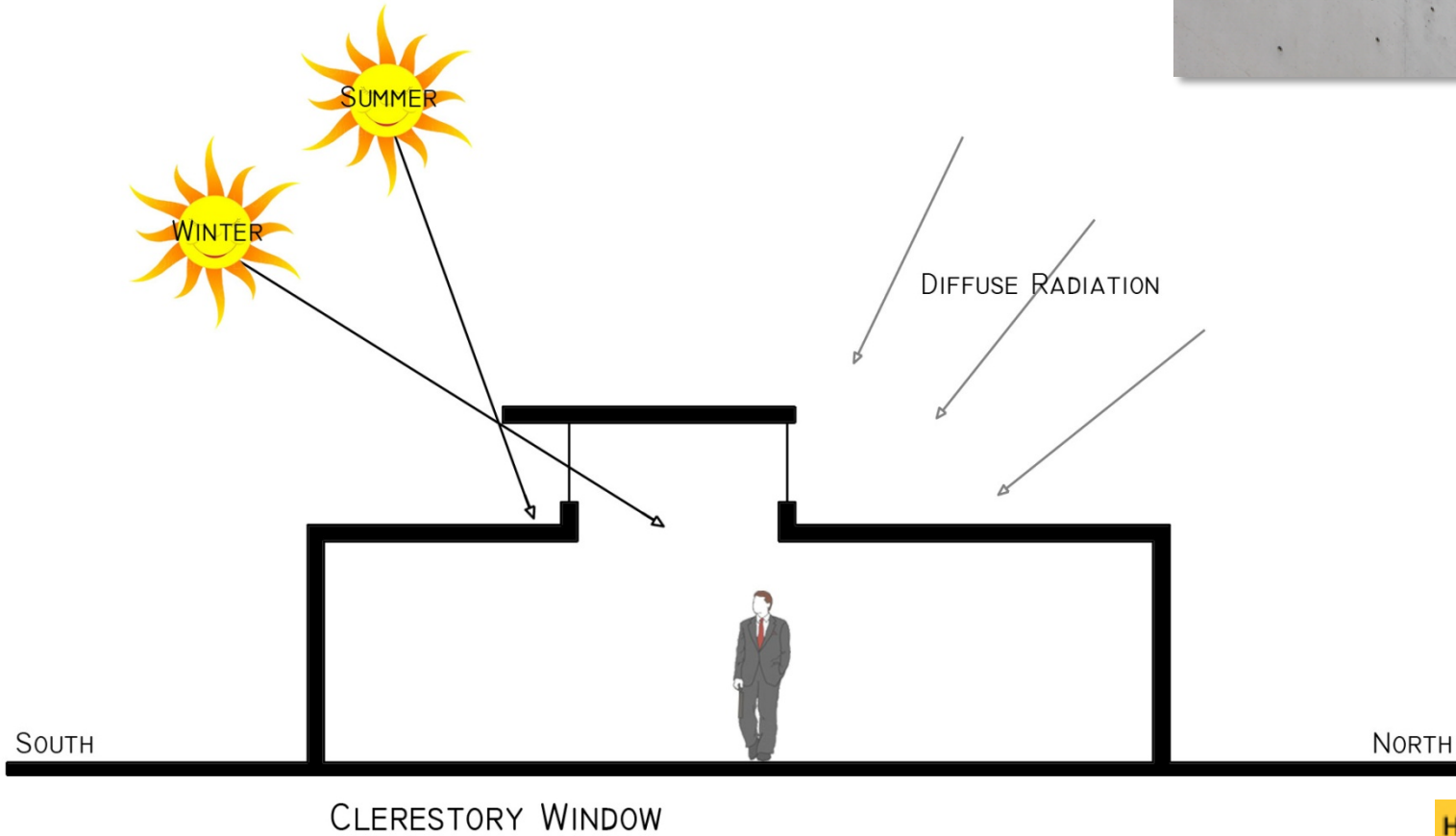

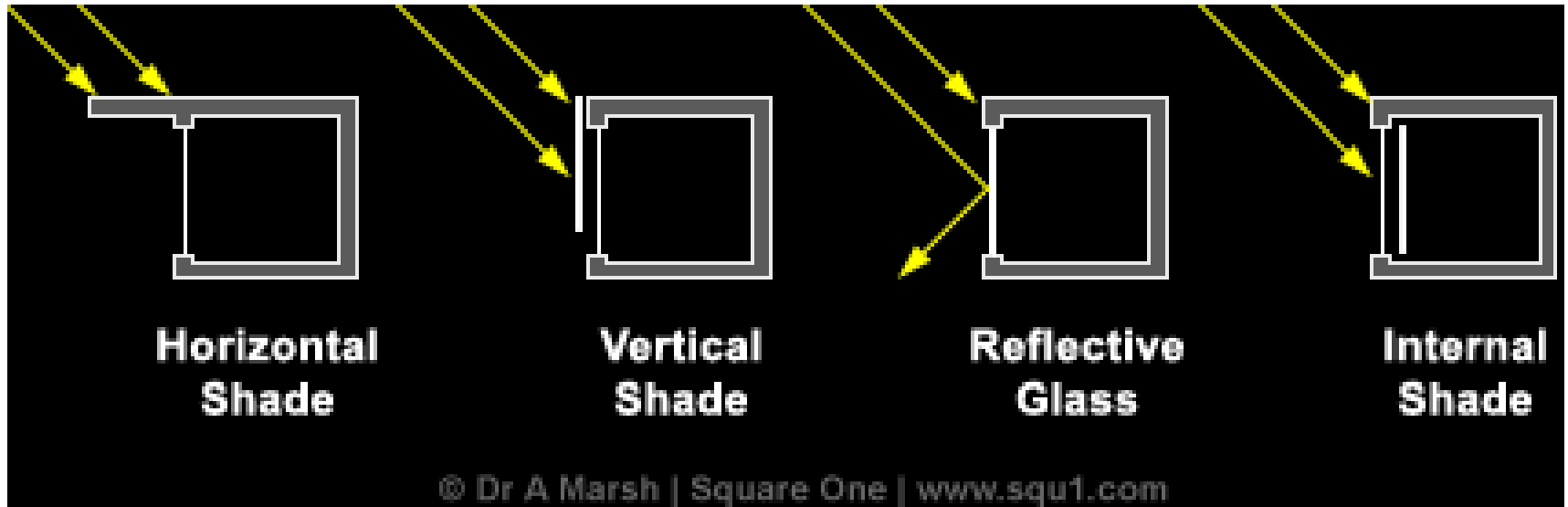

Which ones compromise the view? These also compromise daylight and natural light to the room.

Shading Devices are Not "New"...



Ministry of
Education,
Rio De
Janeiro
(southern
hemisphere)



Le Corbusier used his
"Brise Soleil" to shade
the façades of the
Unite d'Habitation
(northern
hemisphere).



Basic Shading Types

B HORIZONTAL DEVICE

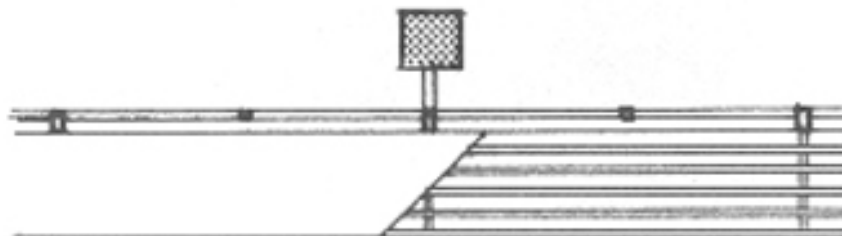
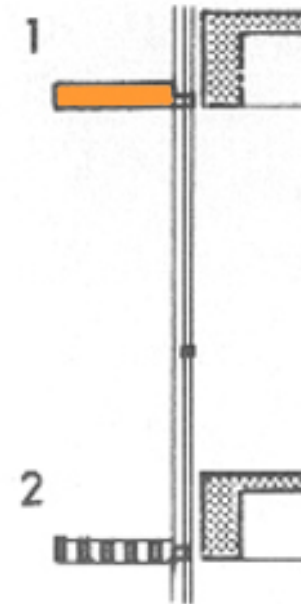
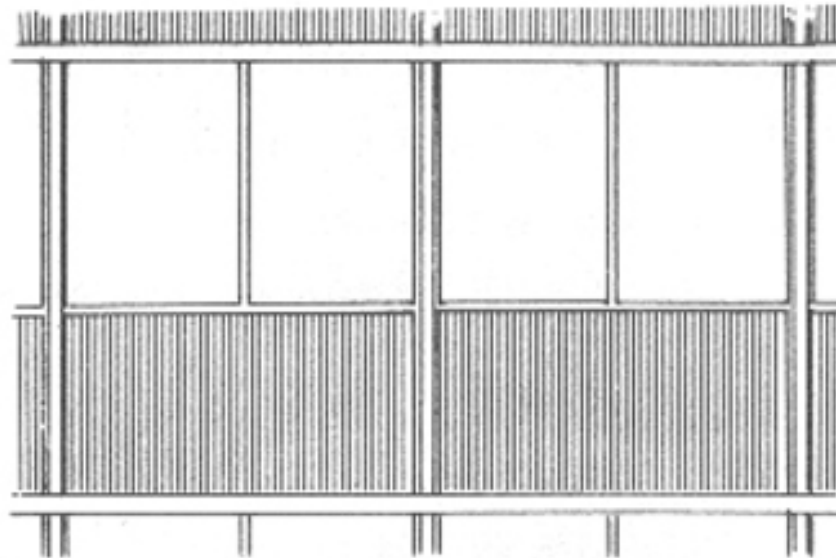

1 = solid

2 = louvered

Basic Shading Types

C VERTICAL FIN

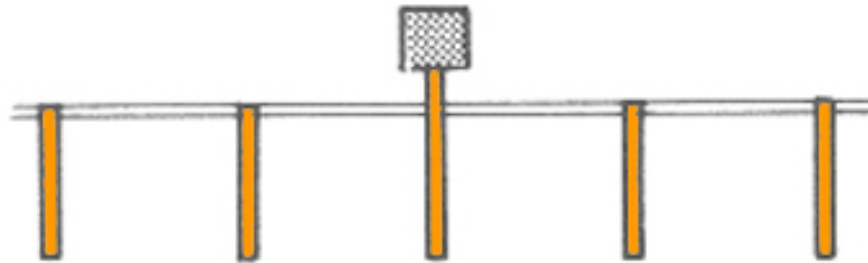
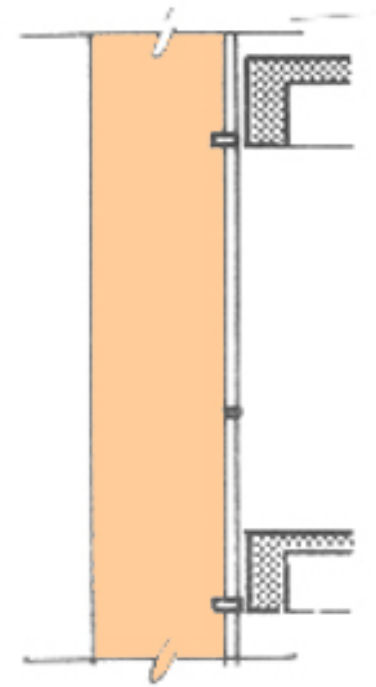
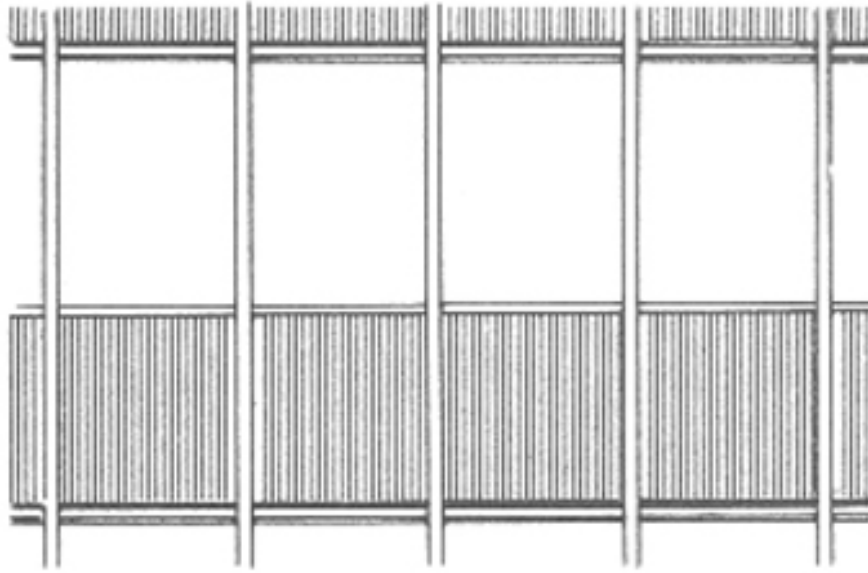

Basic Shading Types

D VERTICAL MOVABLE

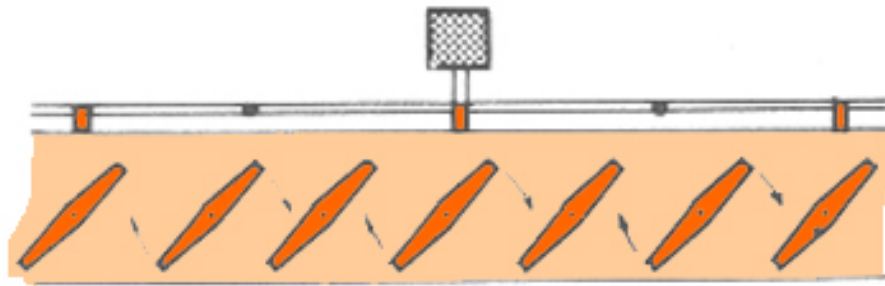
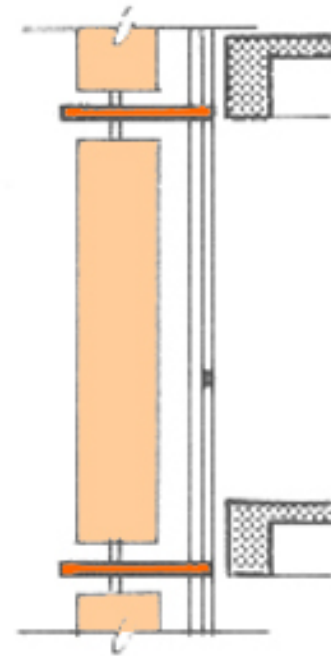
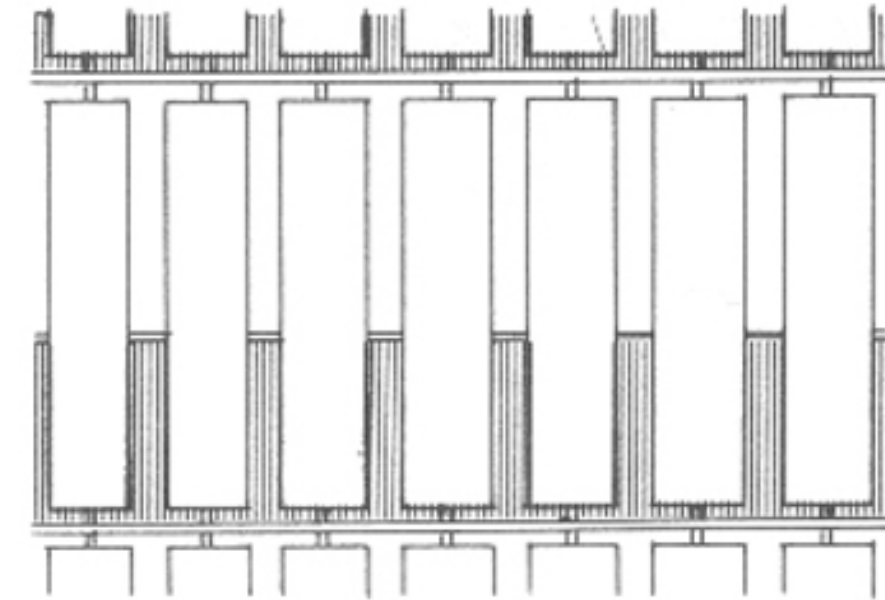

Basic Shading Types

E FIXED EGGRATE

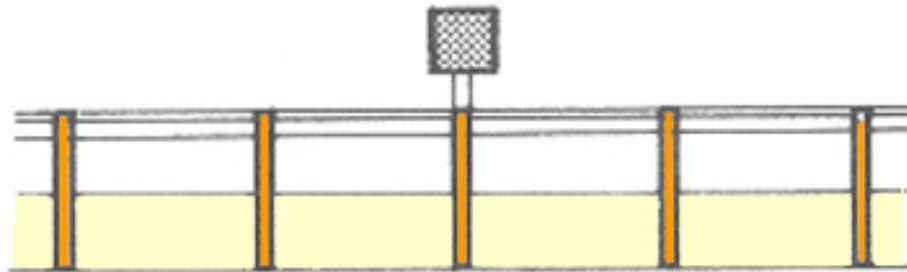
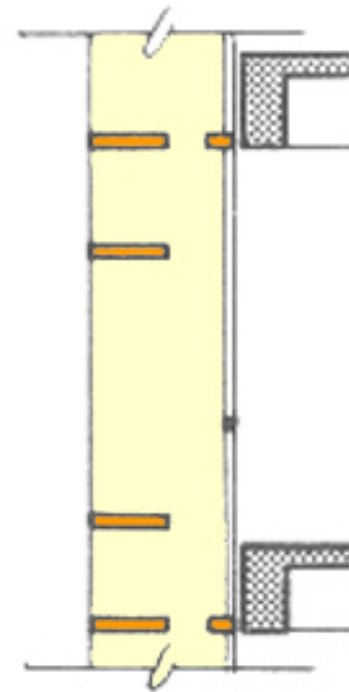
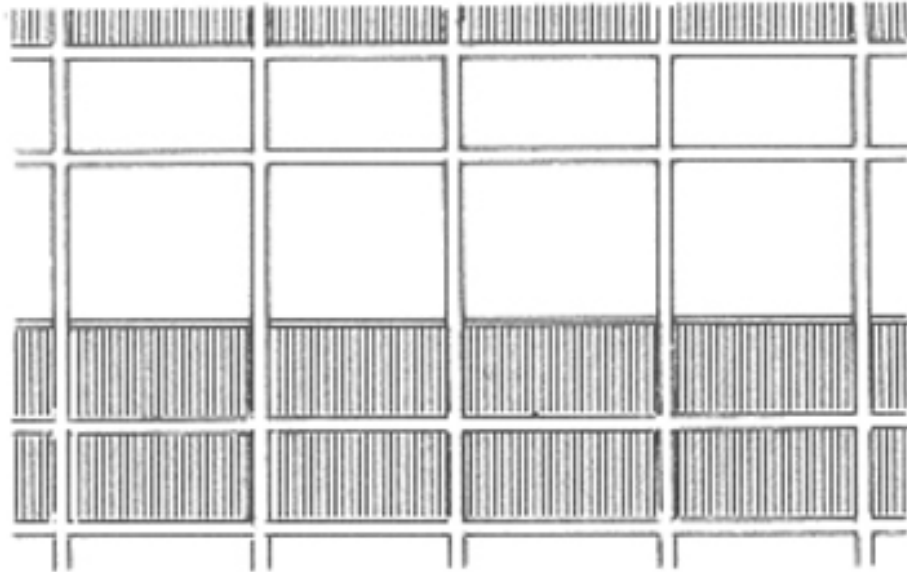

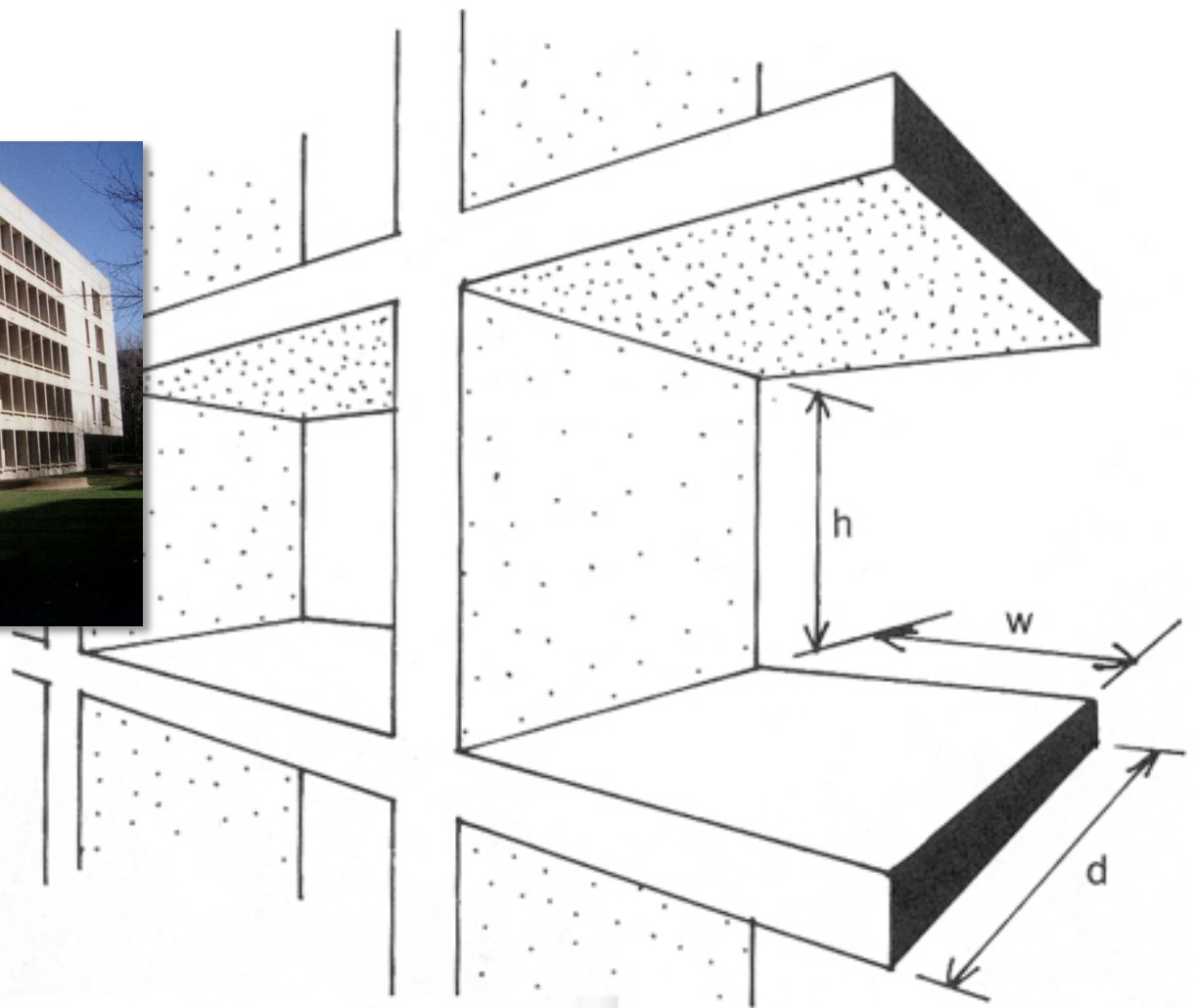

Figure 9.14d The shading effect is a function of the ratios h/d and w/d . It is not a function of actual size.

Even though the grate is removed from the building face, its net effect is somewhat the same.

SECTION

IDEAL ORIENTATION

VIEW RESTRICTION

HORIZONTAL PANEL

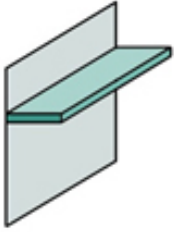

HORIZONTAL LOUVRES
IN HORIZONTAL PLANE

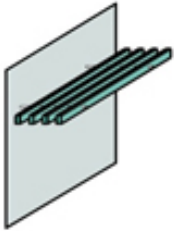

HORIZONTAL LOUVRES
IN VERTICAL PLANE

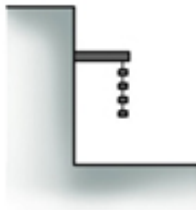
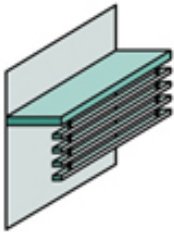

VERTICAL PANEL

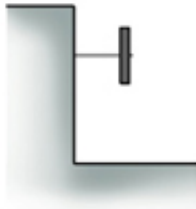
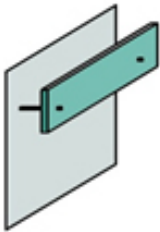

PLAN

IDEAL ORIENTATION

VIEW RESTRICTION

VERTICAL FIN

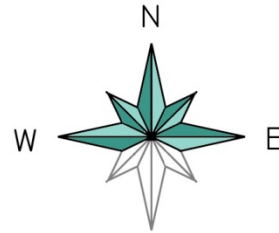
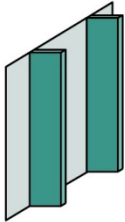

SLANTED VERTICAL FIN

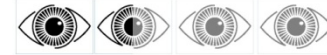
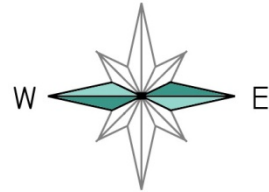
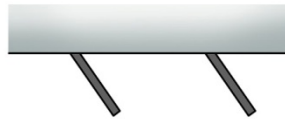
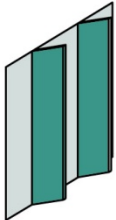

EGGCRATE

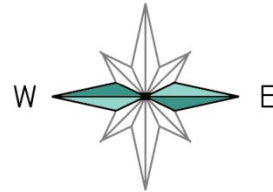
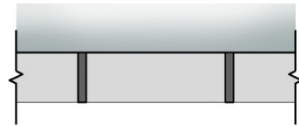
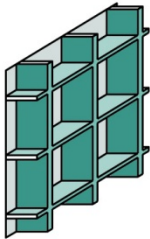

EGGCRATE WITH HORIZONTAL LOUVRES

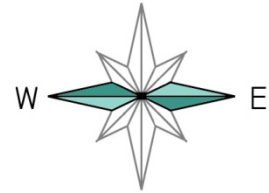
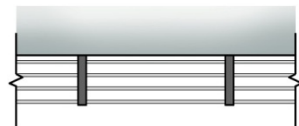
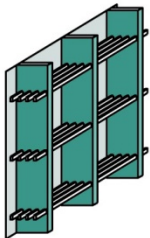

**Solar Geometry tells us that we need
different shading strategies for
each façade ...**

Differentiated Shading Strategies

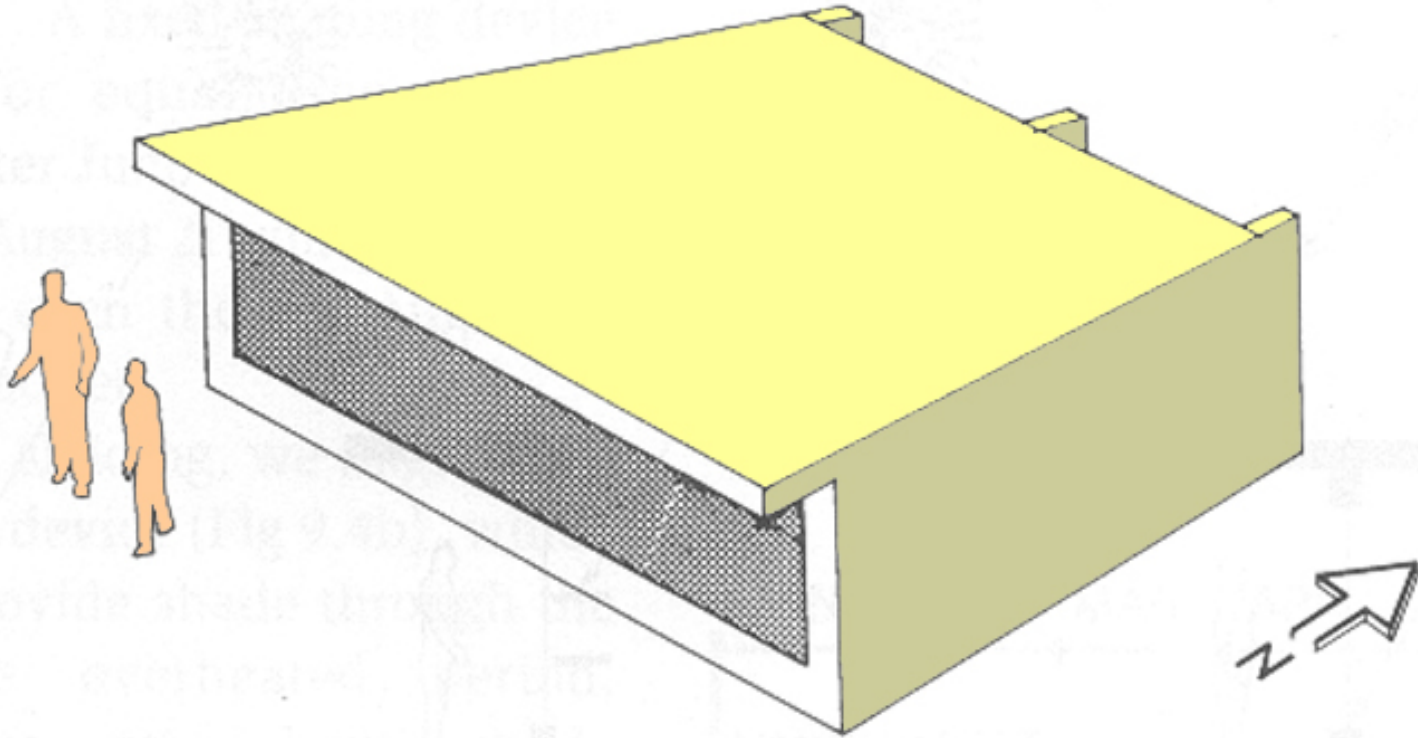

Figure 9.3a Each orientation requires a different shading strategy.

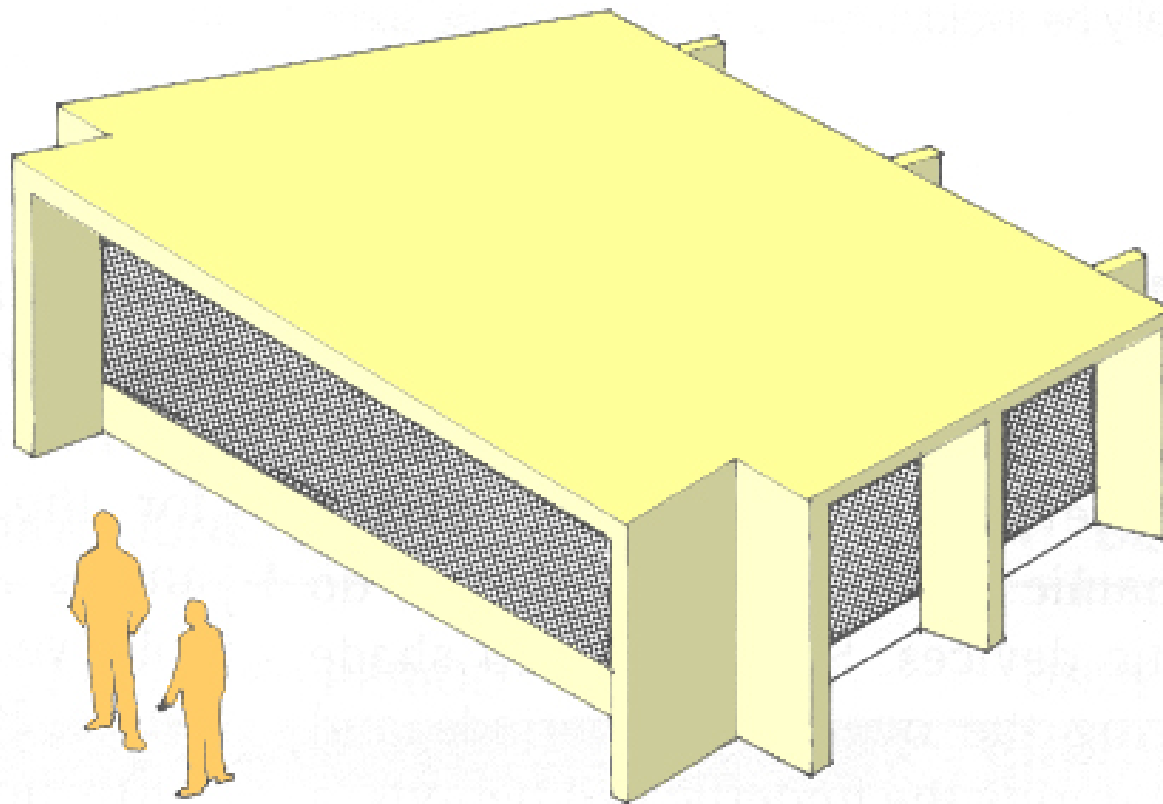
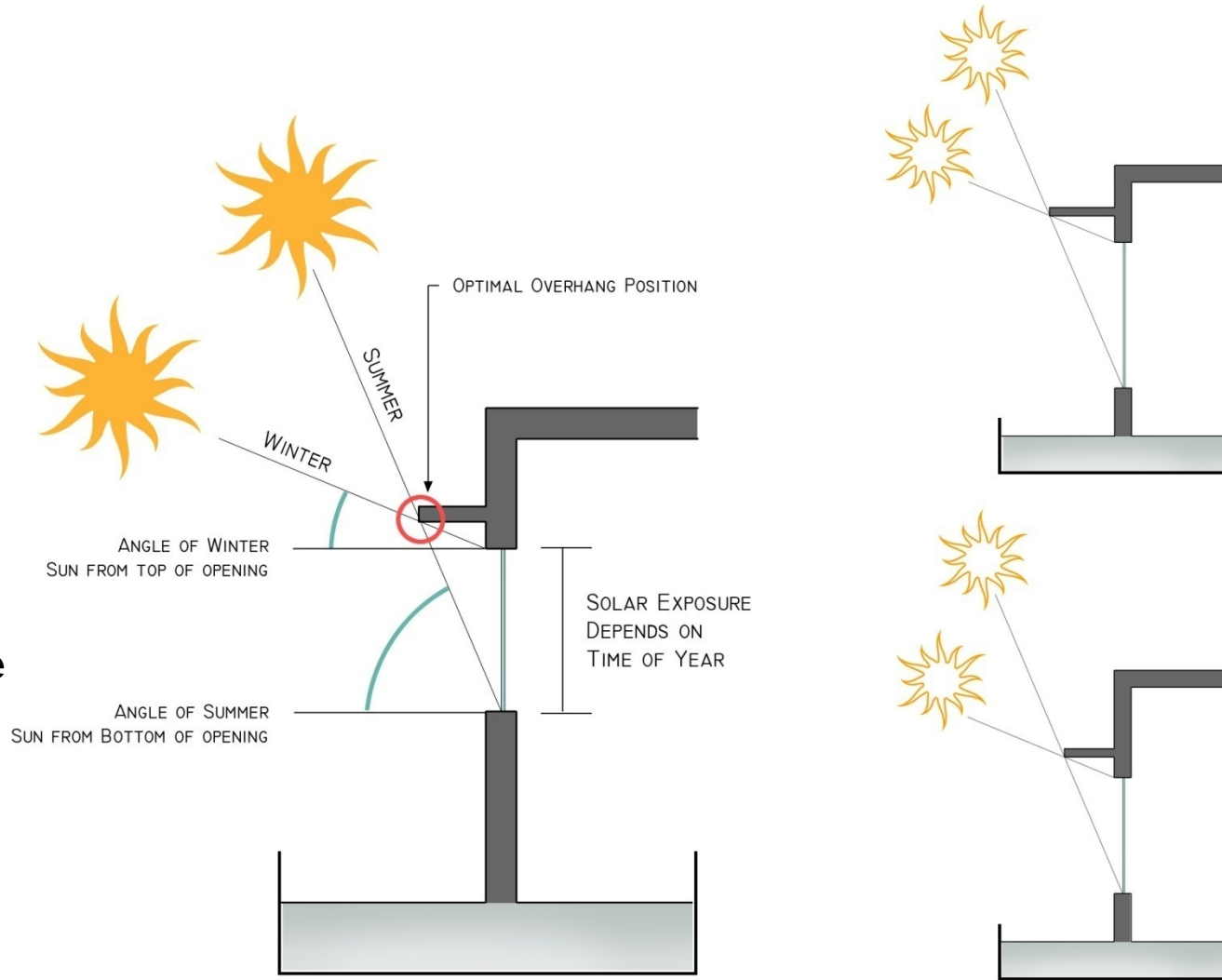

Figure 9.3c Shading is improved when a combination of vertical and horizontal elements is used.

South Facing Shading Strategies

Solar Exposure of Window is a Function of:
Time of Year
vs.
Temperature





A variety of approaches is possible.





Louvered shades are commonly used to:

- prevent snow build up
- allow for ventilation at the façade
- lighter when it comes to loading and support than solid shades

...extend device for full shading

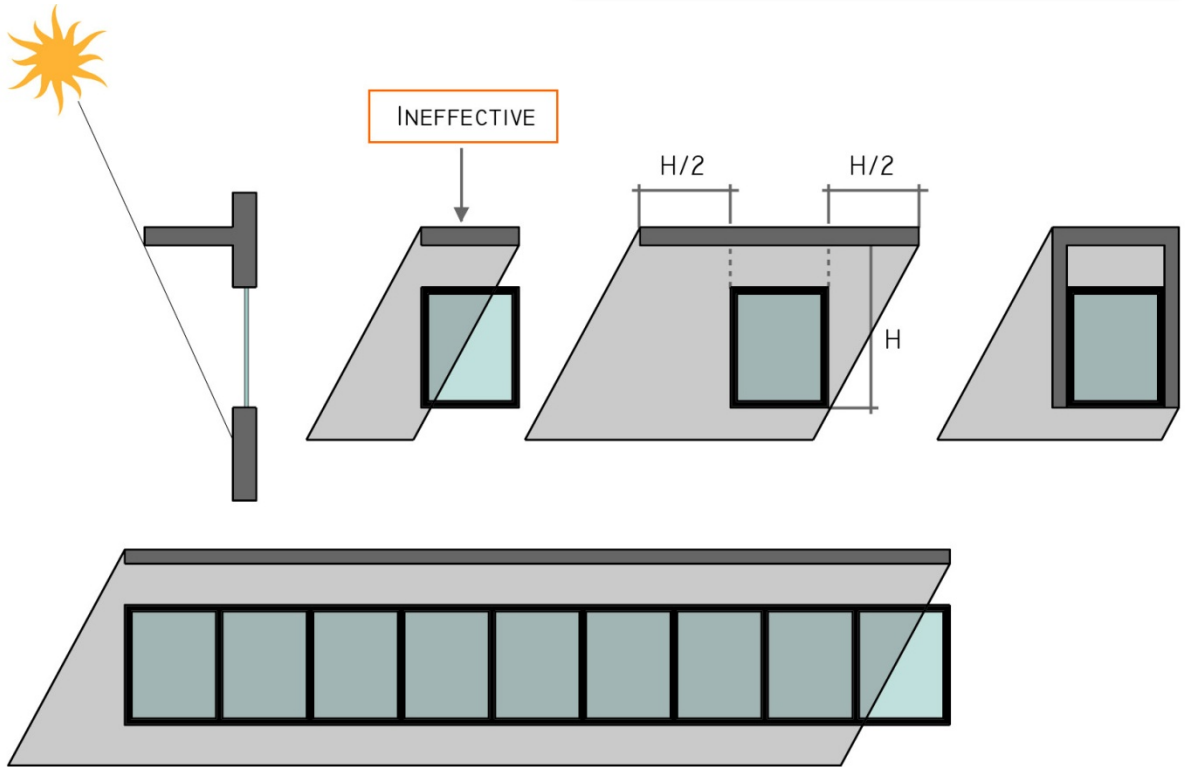
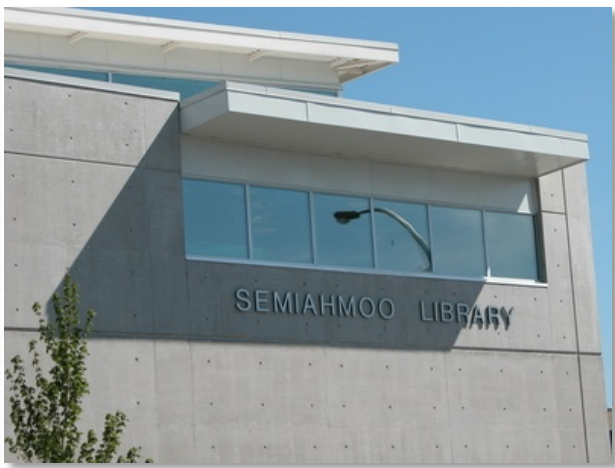

This one uses ceramic fritted glass that is sloped, to allow some light but shed rain and wet snow.

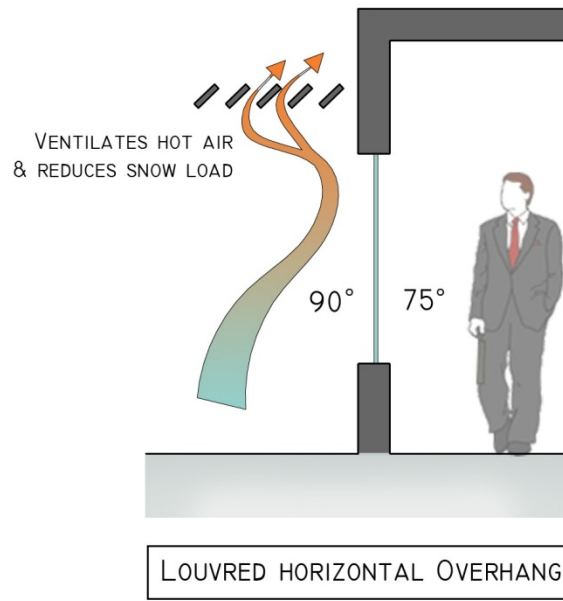
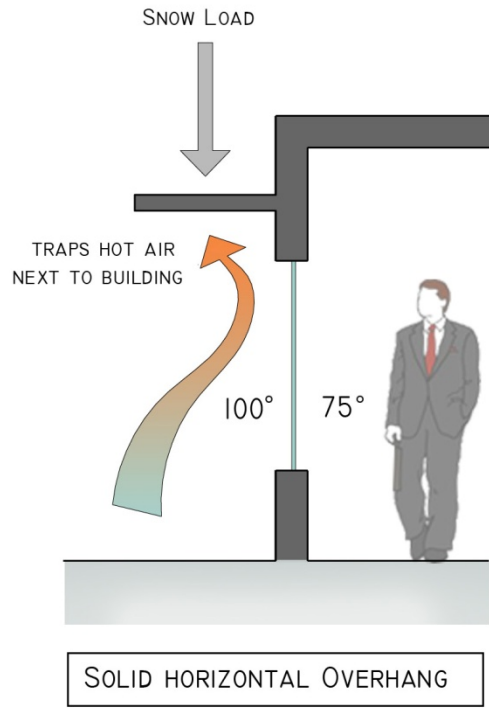

The above two use louvers or grates that will let snow, rain and wind through.

Preventing overheating

A problem inherent in any fixed overhang is its inability to respond to seasonal lag. The warmest period of the summer occurs in early August about 5 or 6 weeks after the summer solstice (June 21 when the sun is highest in the sky). A fixed overhang designed to provide complete shading on June 21 allows unwanted sunlight to enter the window when the daily temperatures are warmest five weeks later.

Conversely designing to provide complete shading during the warmest period (in early August) also results in similar complete shading from mid-May when solar heat may still be desirable.

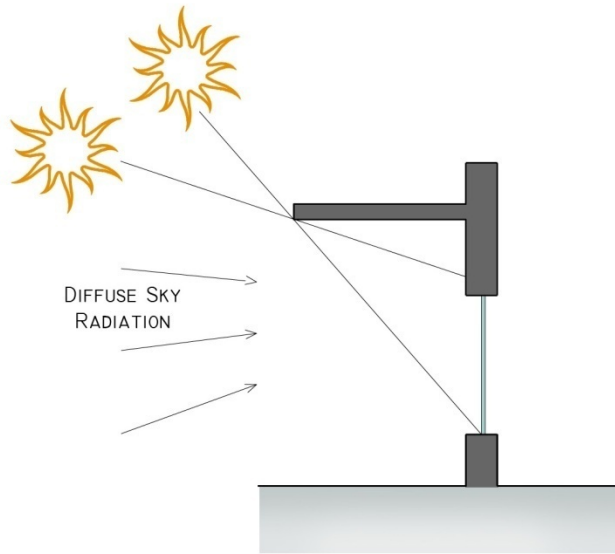
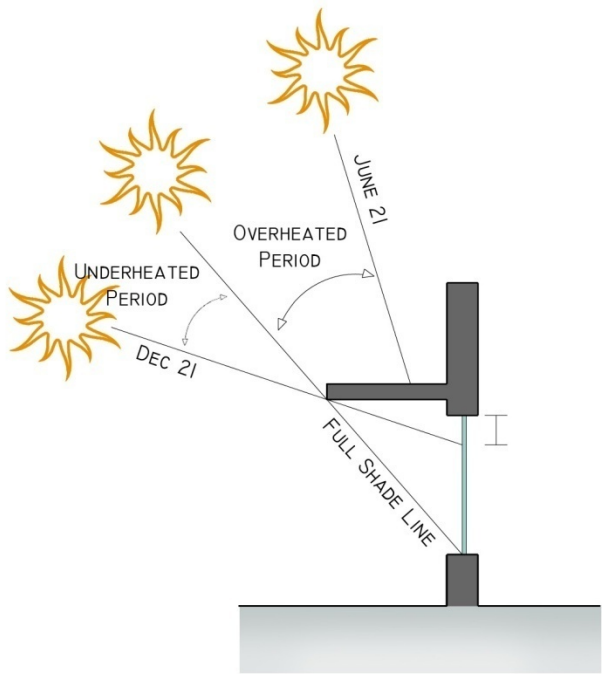

IDEAL CONFIGURATION FOR SOUTH ELEVATIONS 30-50 LATITUDE

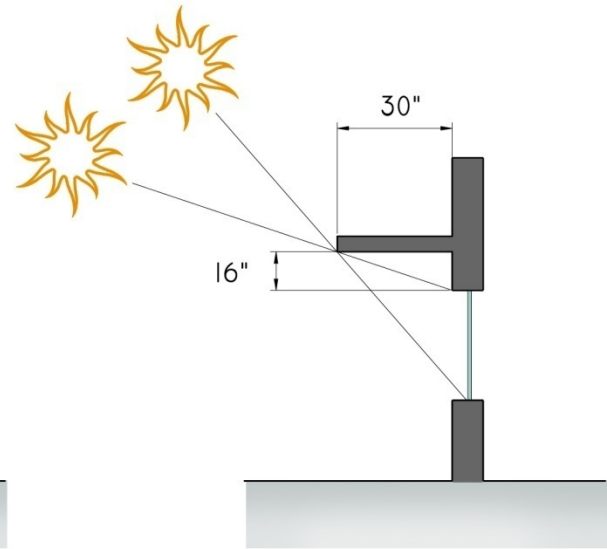

● HIGH OVERHANGS ARE NOT RECOMMENDED FOR HUMID CLIMATES BECAUSE OF THE EXCESS OF DIFFUSE SKY RADIATION

Adjustable overhangs provide a solution to seasonal lag.

Some ideas might work well "in a drawing", but think carefully before you use any devices that require hinges or motion in climates where snow and ice will cause wear.

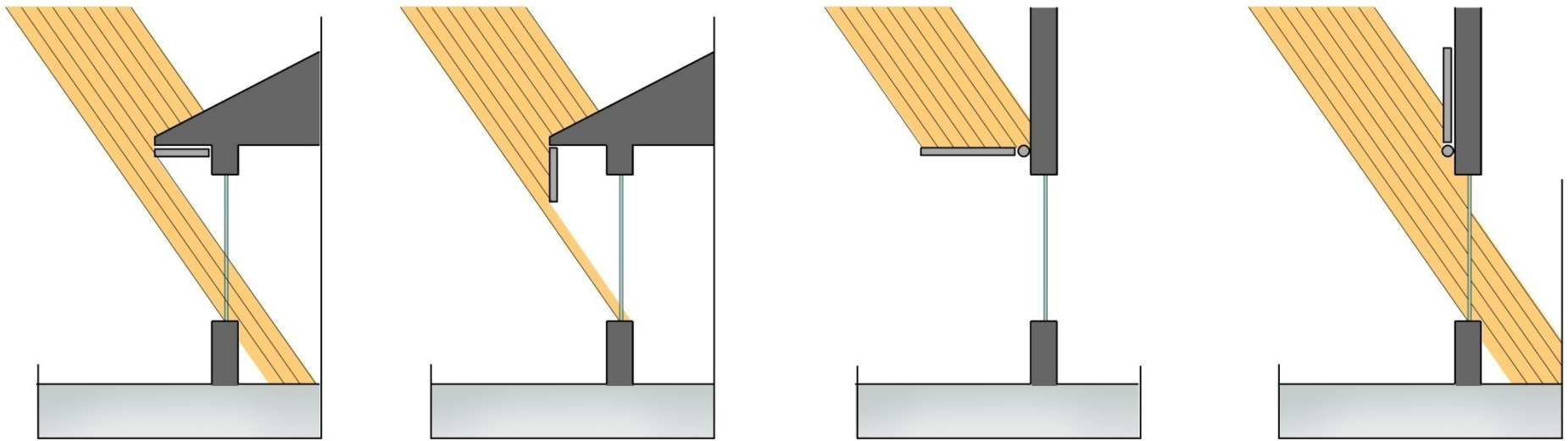

IN THEORY, A HINGED, TWO-POSITION SHADING DEVICE AN EFFECTIVE SOLUTION.
... BUT CONSIDER ITS PRACTICALITY.

Living Awnings such as deciduous trees and trellises with deciduous vines are very good shading devices. They are in phase with the thermal year - gain and lose leaves in response to temperature changes.

SOLAR TRANSMISSION CAN BE AS LOW AS 20% FOR A MATURE TREE IN THE SUMMER

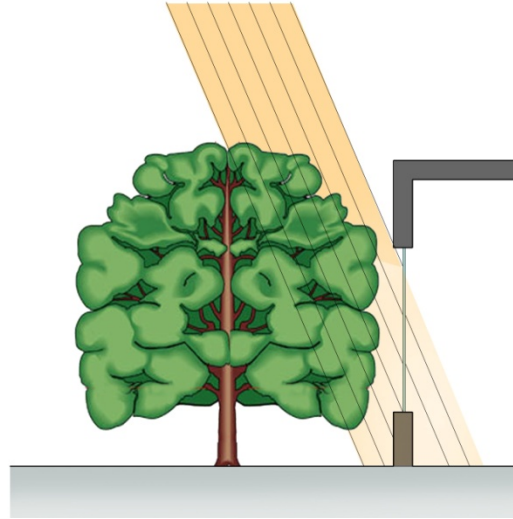

SOLAR TRANSMISSION CAN BE AS HIGH AS 70% FOR A MATURE TREE IN THE WINTER

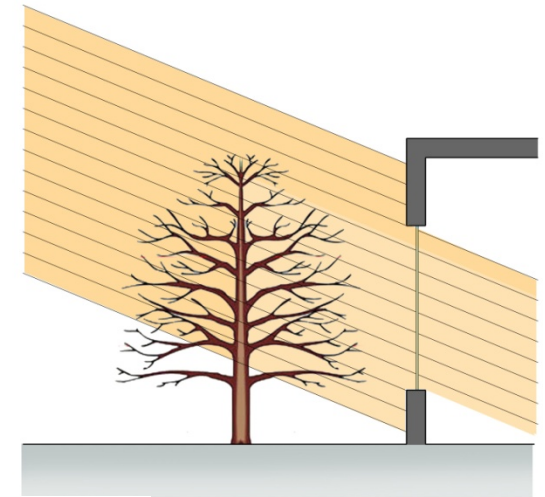

OTHER LIVING SHADE OPTIONS:

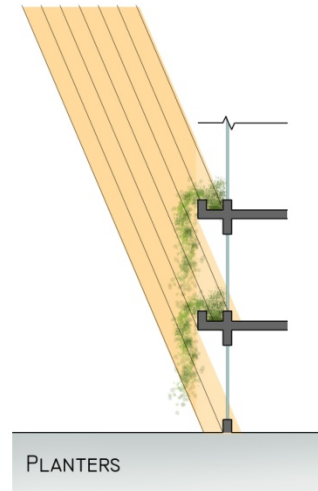
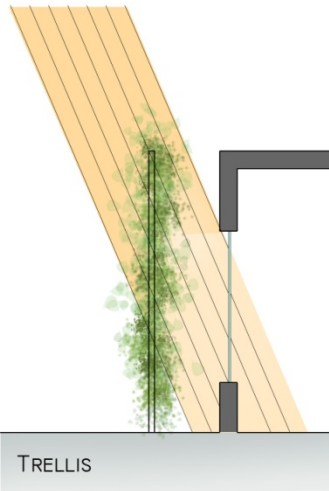

Center for Regenerative
Studies, Cal Poly Pomona



Ketchum Residence, ON,
Sustainable EDGE Inc.



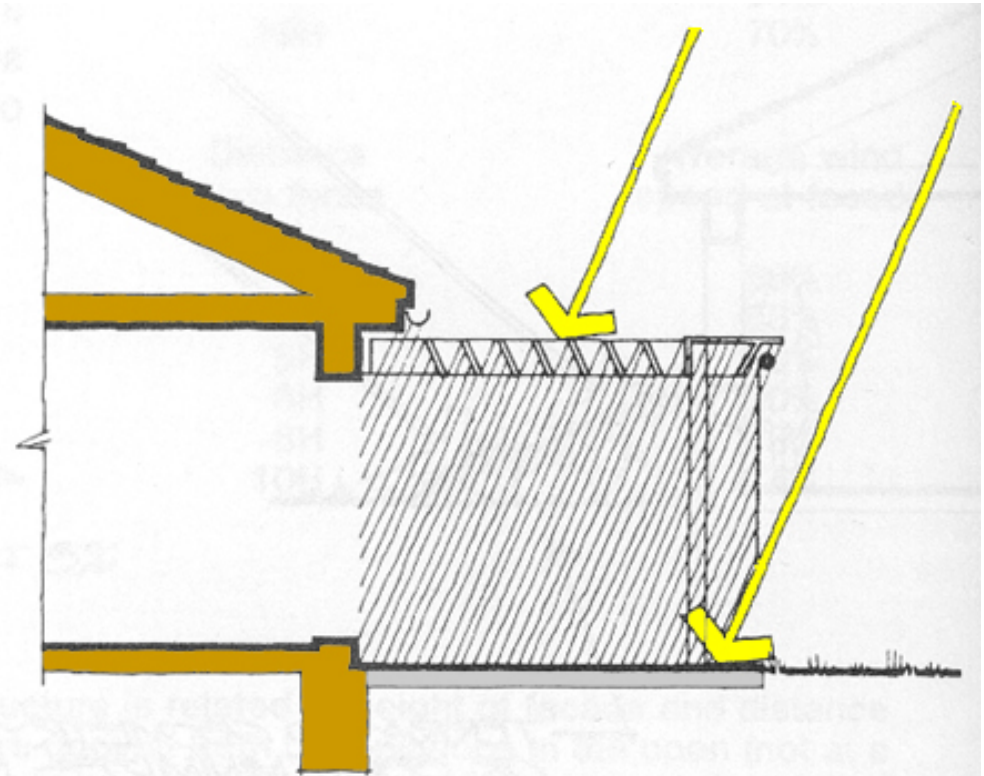
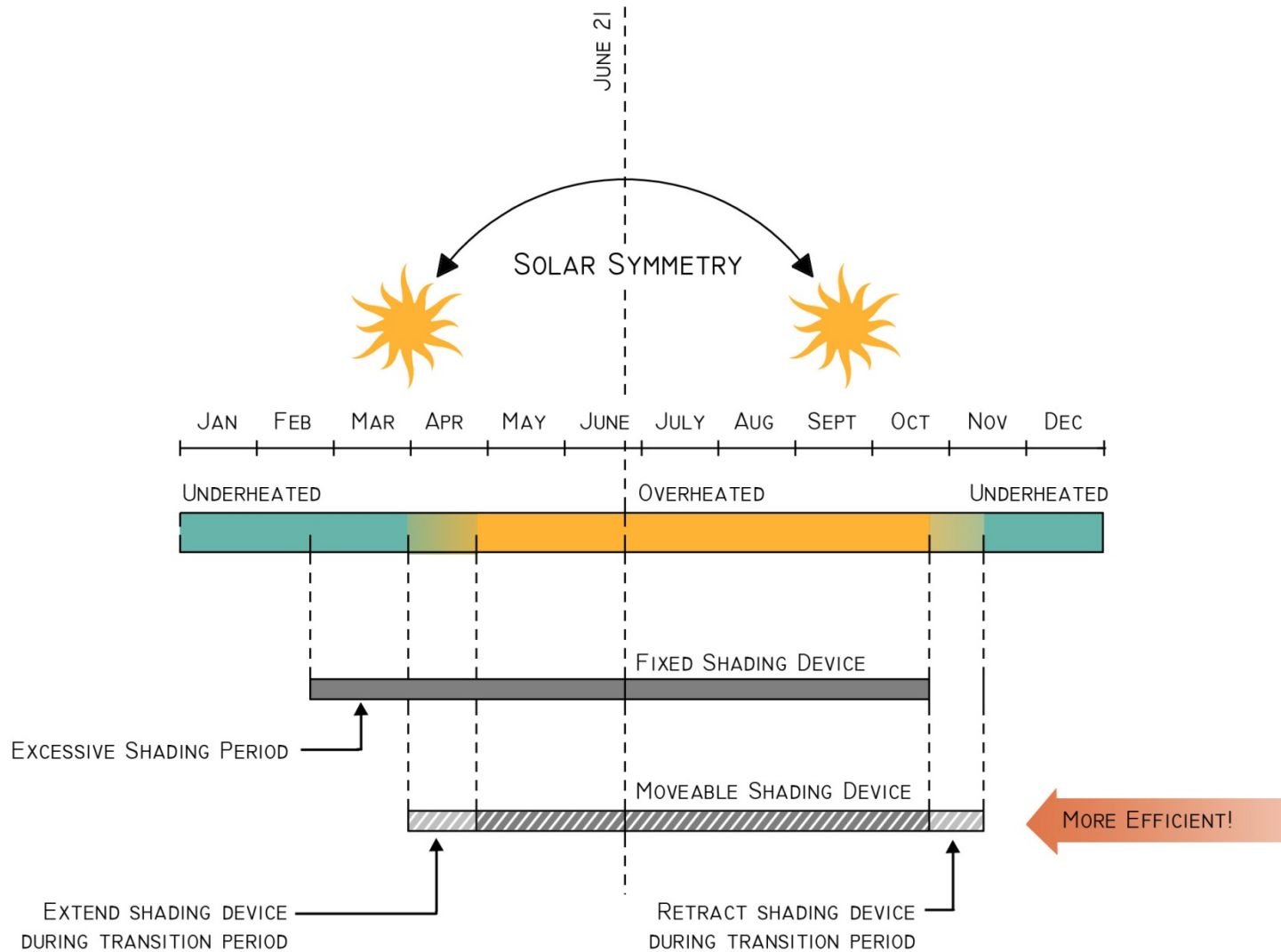
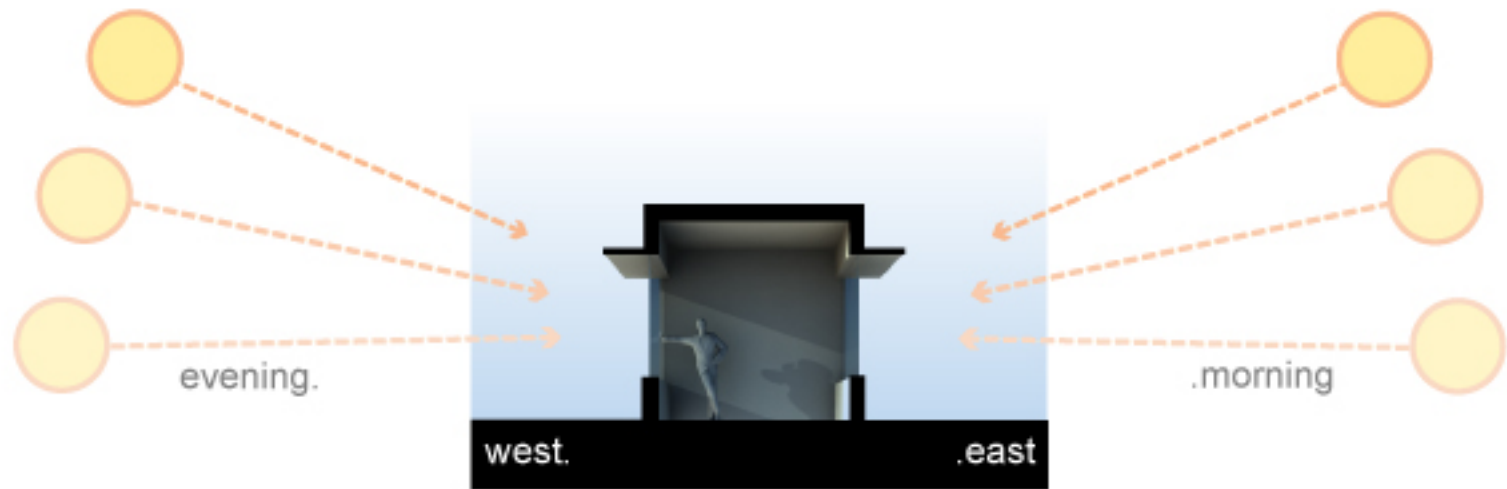

FIG. 4d. Attached overhead shading structures can provide multiple benefits. Not only does this patio cover shade the wall, it also reduces reflected gain from loading on the wall.

Preventing overheating



Shading Strategies for West and East Elevations



Horizontal overhangs DO NOT work on east & west facades.

SOLAR AZIMUTH RANGE THROUGHOUT THE YEAR

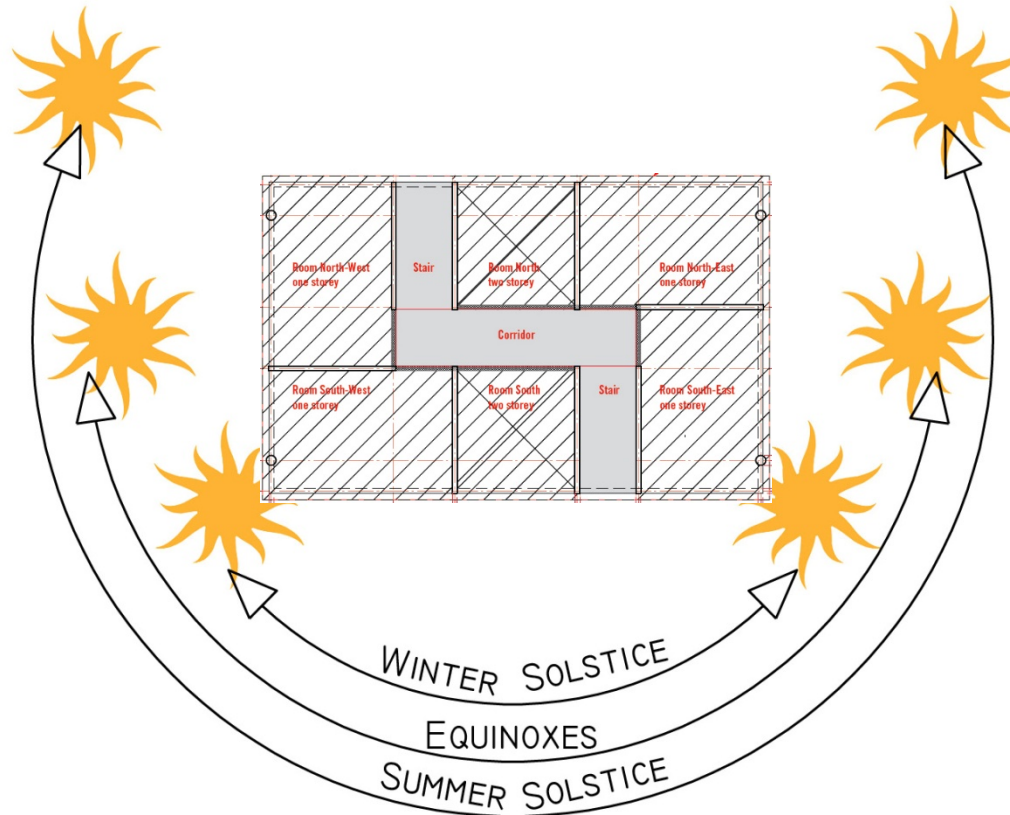

Since little winter heating can be expected from east and west windows, shading devices on those orientations can be designed purely on the basis of the summer requirement.

1. The best solution by far is to limit using east and especially west windows (as much as possible in hot climates)



AVOID WINDOWS ON THE EAST & WEST FACADE
BY SHIFTING THE WINDOWS TO FACE NORTH OR SOUTH:

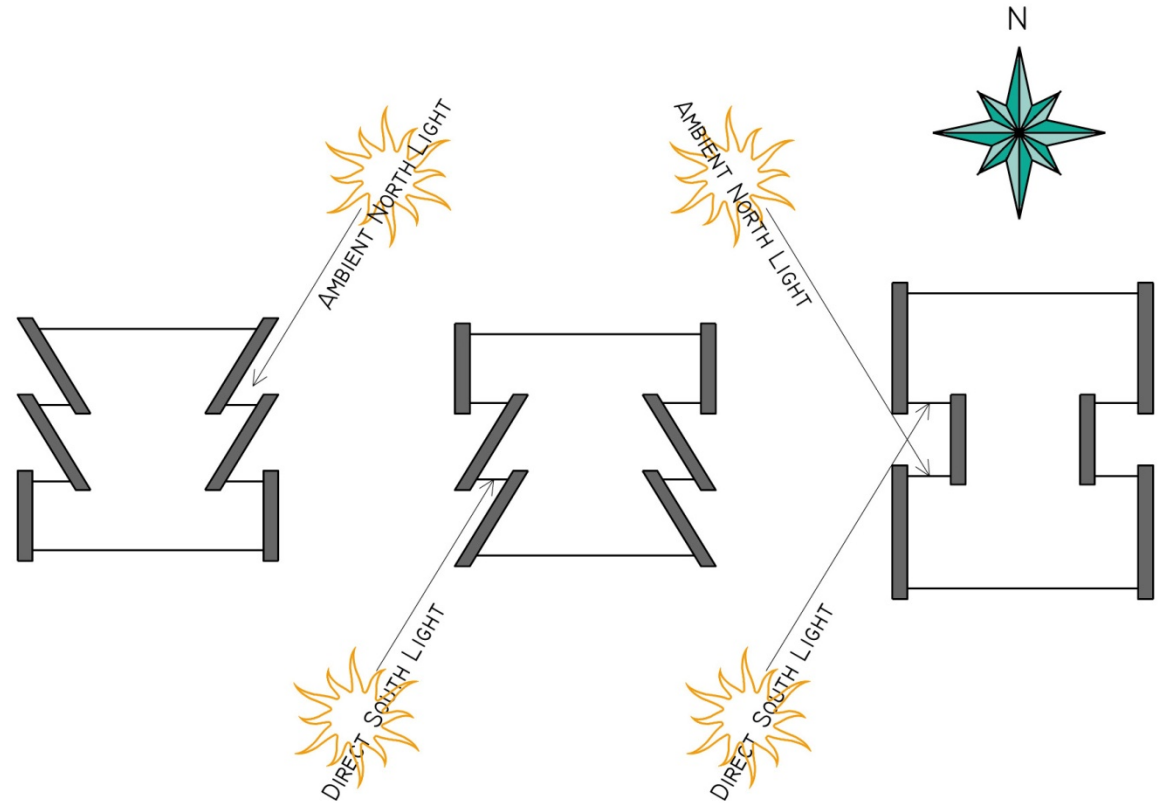

2. Next best solution is to have windows on the east and west façades face north or south

Shading Strategies for West and East Elevations

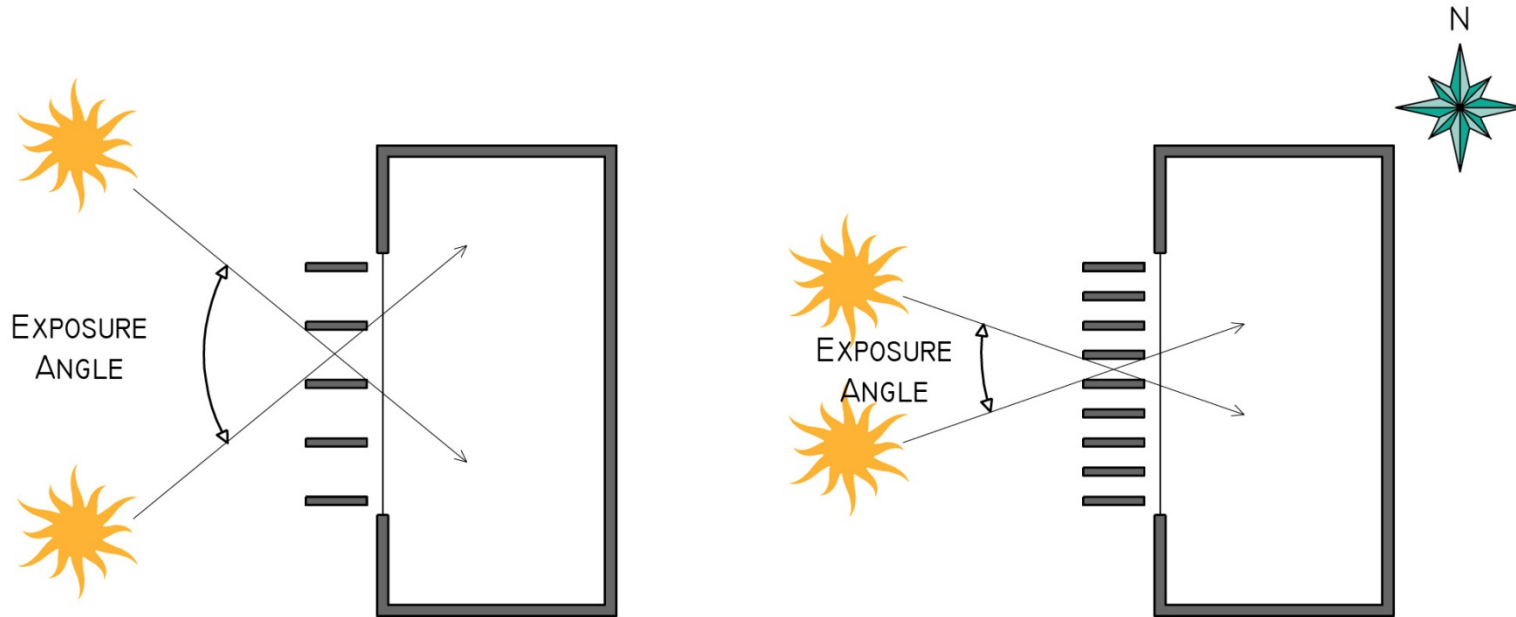

SOLAR PENETRATION IS REDUCED BY MOVING FINS CLOSER TOGETHER, MAKING THEM DEEPER, OR BOTH.

3. Use Vertical Fins. Spacing is an issue, as well as fin length. Must be understood that if to be effective, they will severely restrict the view.

TABLE 9.12
SHADE LINE ANGLE FOR SLANTED
VERTICAL FINS*

Latitude	Angle "D"
24	18
28	15
32	12
36	10
40	9
44	8
48	7

* This table is for vertical fins slanted toward the north on east or west windows. Designs based on this table will provide shade from direct sun for the whole year between the hours of 7 A.M. and 5 P.M. (solar time). This table can also be used to design vertical fins on north windows for the same time period.



SLANTED VERTICAL FIN STRATEGY ON EAST & WEST FACADES:

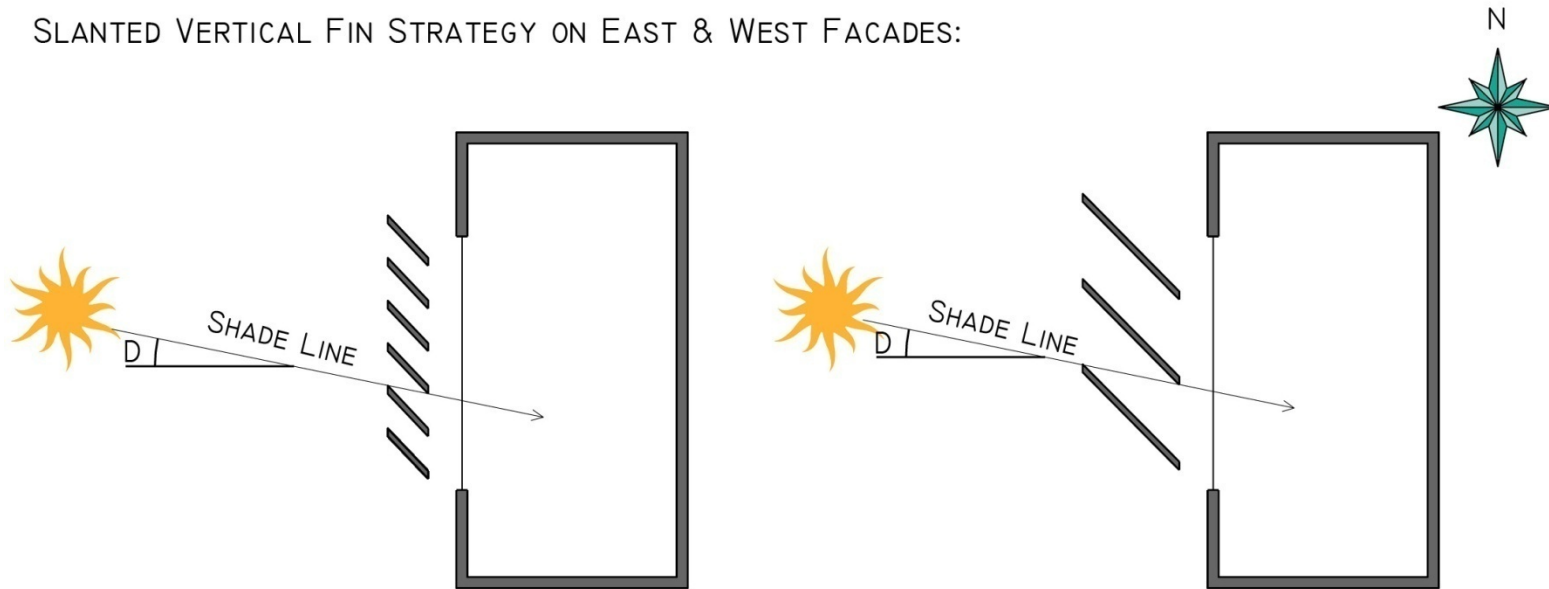

THE "SHADE LINE" AT ANGLE "D" DETERMINES FIN SPACING, DEPTH & SLANT

VERTICAL FIN STRATEGY ON NORTH FACADE:

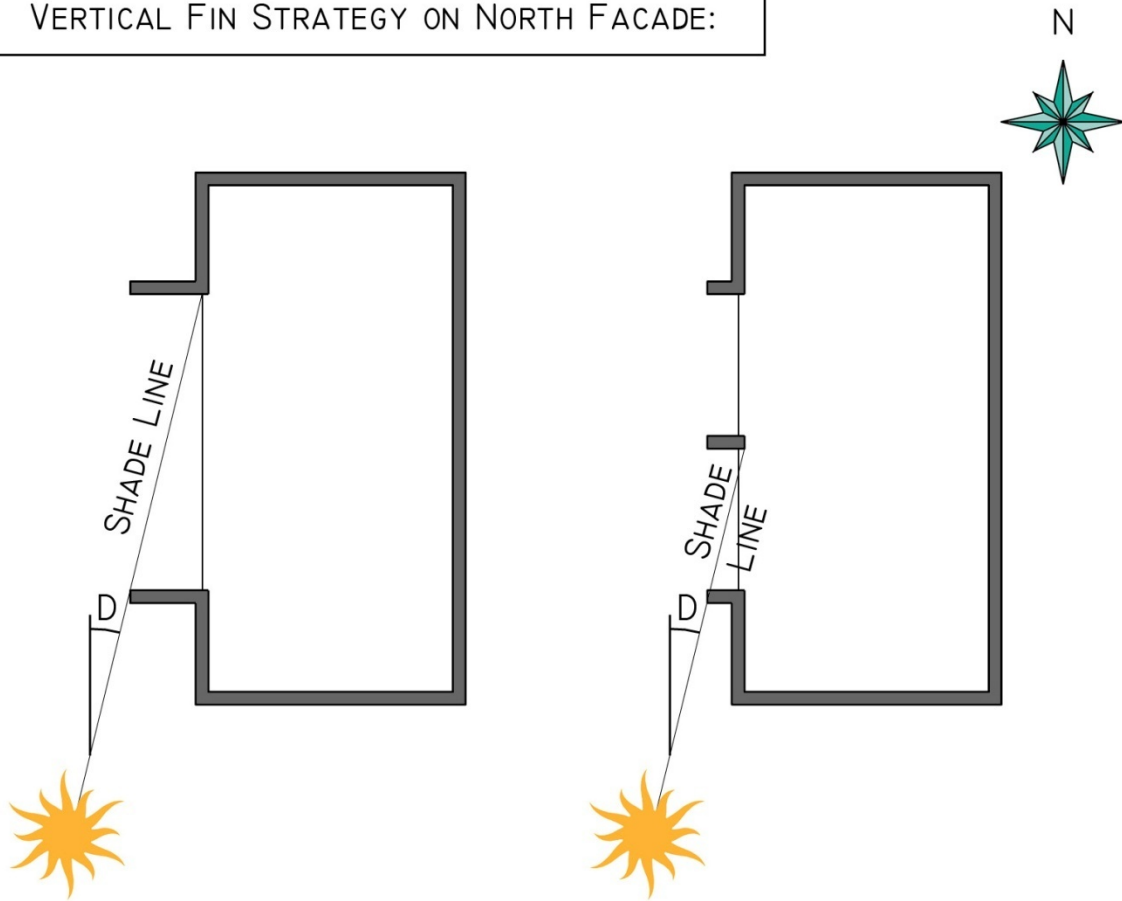

THE "SHADE LINE" AT ANGLE "D" DETERMINES FIN SPACING & DEPTH.

TABLE 9.12
SHADE LINE ANGLE FOR SLANTED
VERTICAL FINS *

Latitude	Angle "D"
24	18
28	15
32	12
36	10
40	9
44	8
48	7

* This table is for vertical fins slanted toward the north on east or west windows. Designs based on this table will provide shade from direct sun for the whole year between the hours of 7 A.M. and 5 P.M. (solar time). This table can also be used to design vertical fins on north windows for the same time period.

HCL

The sun also hits the façade from the north east and north west during the summer. Fins can be used to control this oblique light as well. It is a function of the latitude, window size and fin depth/frequency.

Interior vs. Exterior Shades

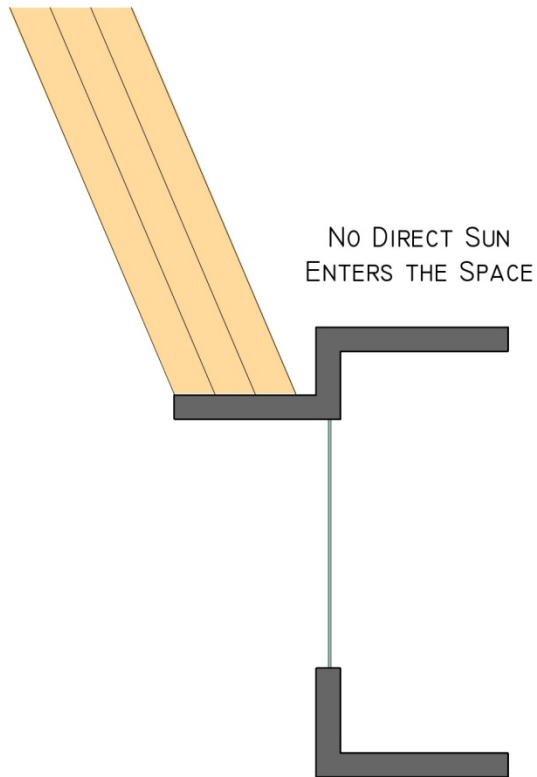

EXTERNAL SHADE: OVERHANG

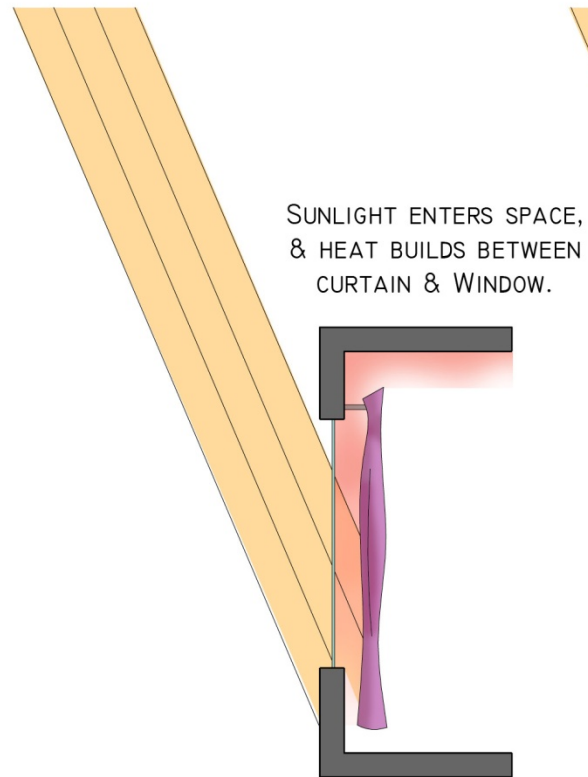

INTERNAL SHADE: CURTAIN

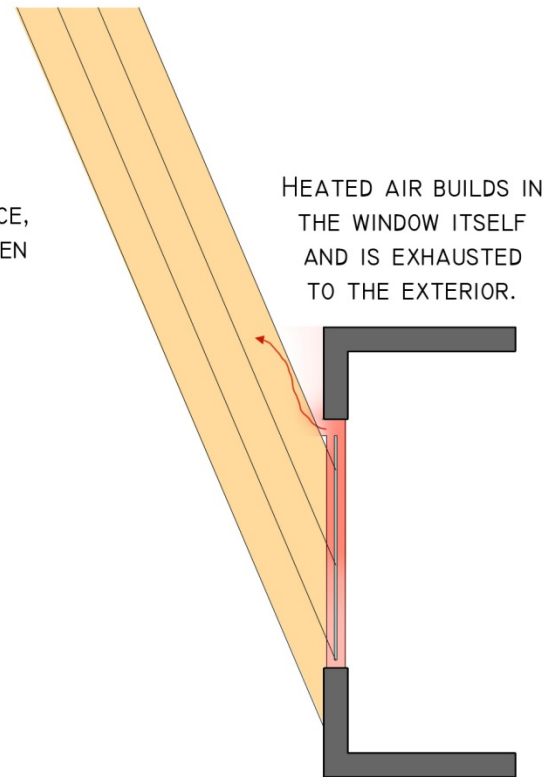

BLIND WITHIN DOUBLE GLAZED WINDOW

Once the heat is IN, it is IN!

Skylights vs. Clerestories

SLOPED/HORIZONTAL GLAZING: SKYLIGHT

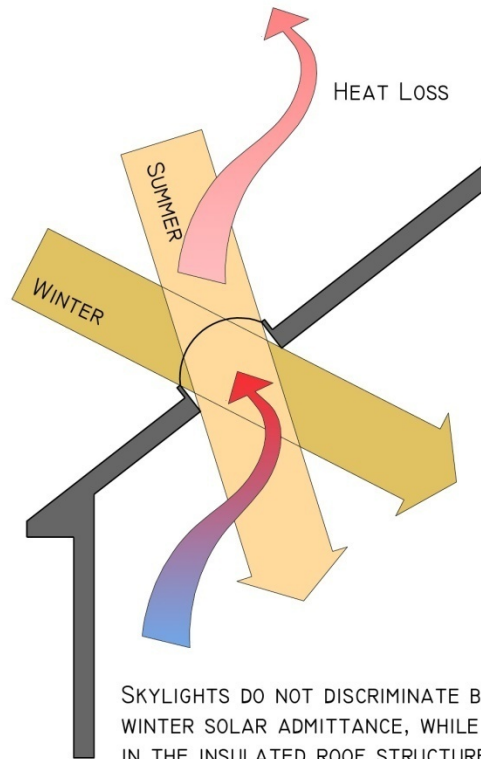

SKYLIGHTS DO NOT DISCRIMINATE BETWEEN SUMMER & WINTER SOLAR ADMITTANCE, WHILE ALSO CREATING A HOLE IN THE INSULATED ROOF STRUCTURE.

- RESULT = OVERHEATING IN SUMMER & EXCESSIVE HEAT LOSS IN WINTER

VERTICAL GLAZING: DORMER/CLERESTORY

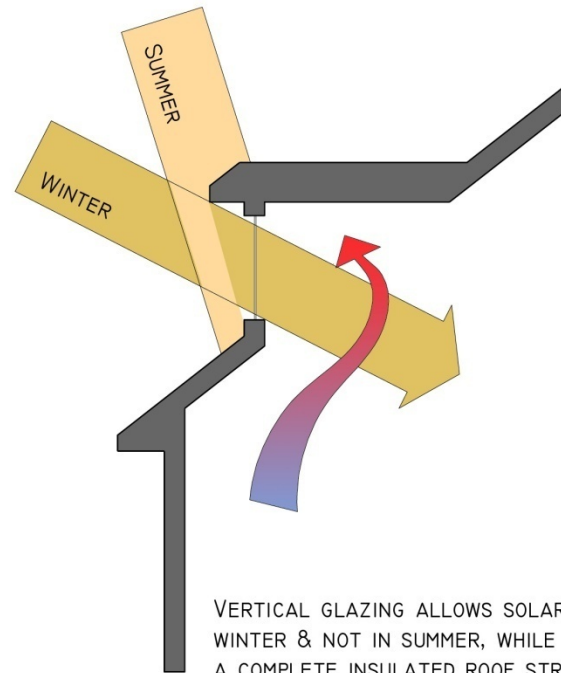

VERTICAL GLAZING ALLOWS SOLAR ADMITTANCE IN WINTER & NOT IN SUMMER, WHILE ALSO MAINTAINING A COMPLETE INSULATED ROOF STRUCTURE.

- RESULT = NATURAL DAYLIGHTING & THERMAL COMFORT YEAR-ROUND

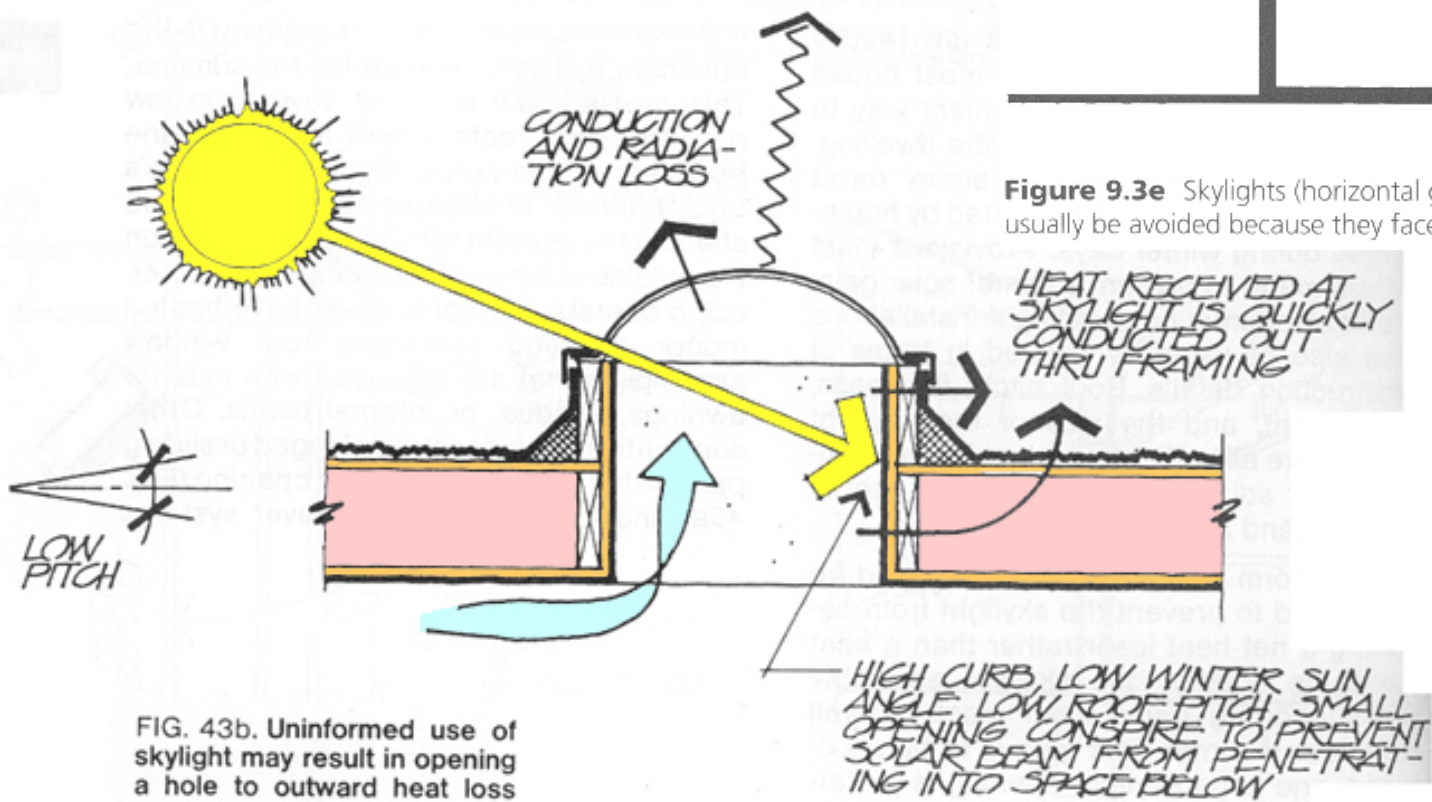

FIG. 43b. Uninformed use of skylight may result in opening a hole to outward heat loss with little compensating gain. The result may be summer overheating and winter net heat loss.

Figure 9.3e Skylights (horizontal glazing) should usually be avoided because they face the summer sun.

HCL

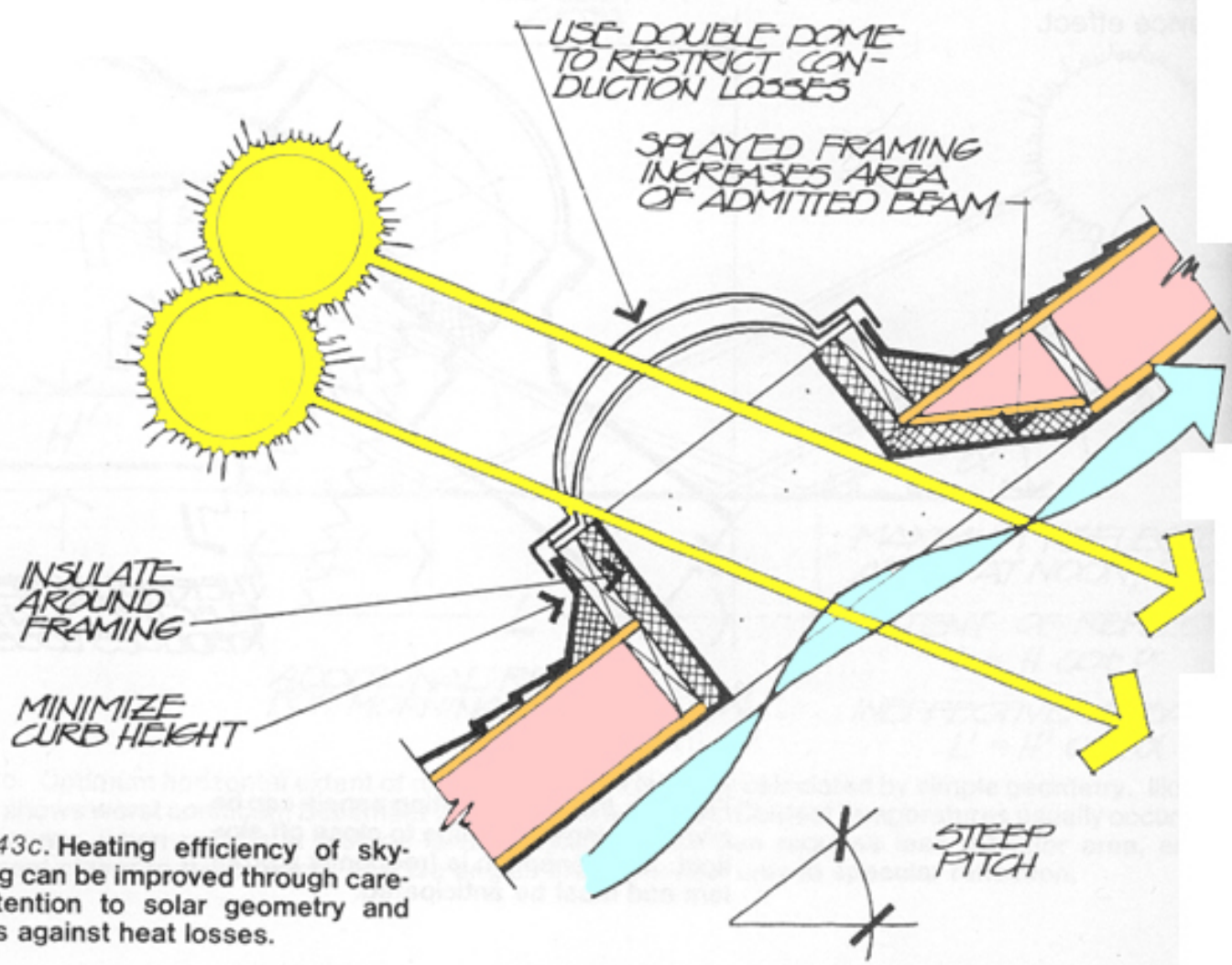

FIG. 43c. Heating efficiency of skylighting can be improved through careful attention to solar geometry and guards against heat losses.



F
a
c
i
r
s
o

Learning how to plot shadows...

- important to get a quick and dirty understanding of your building and its shadow patterns (both INTERIOR and EXTERIOR)
- need to do this BEFORE you commit to extensive designs
- can use computers to simulate
- can do sun angle diagrams
- can build a quick massing model and model it on a HELIODON

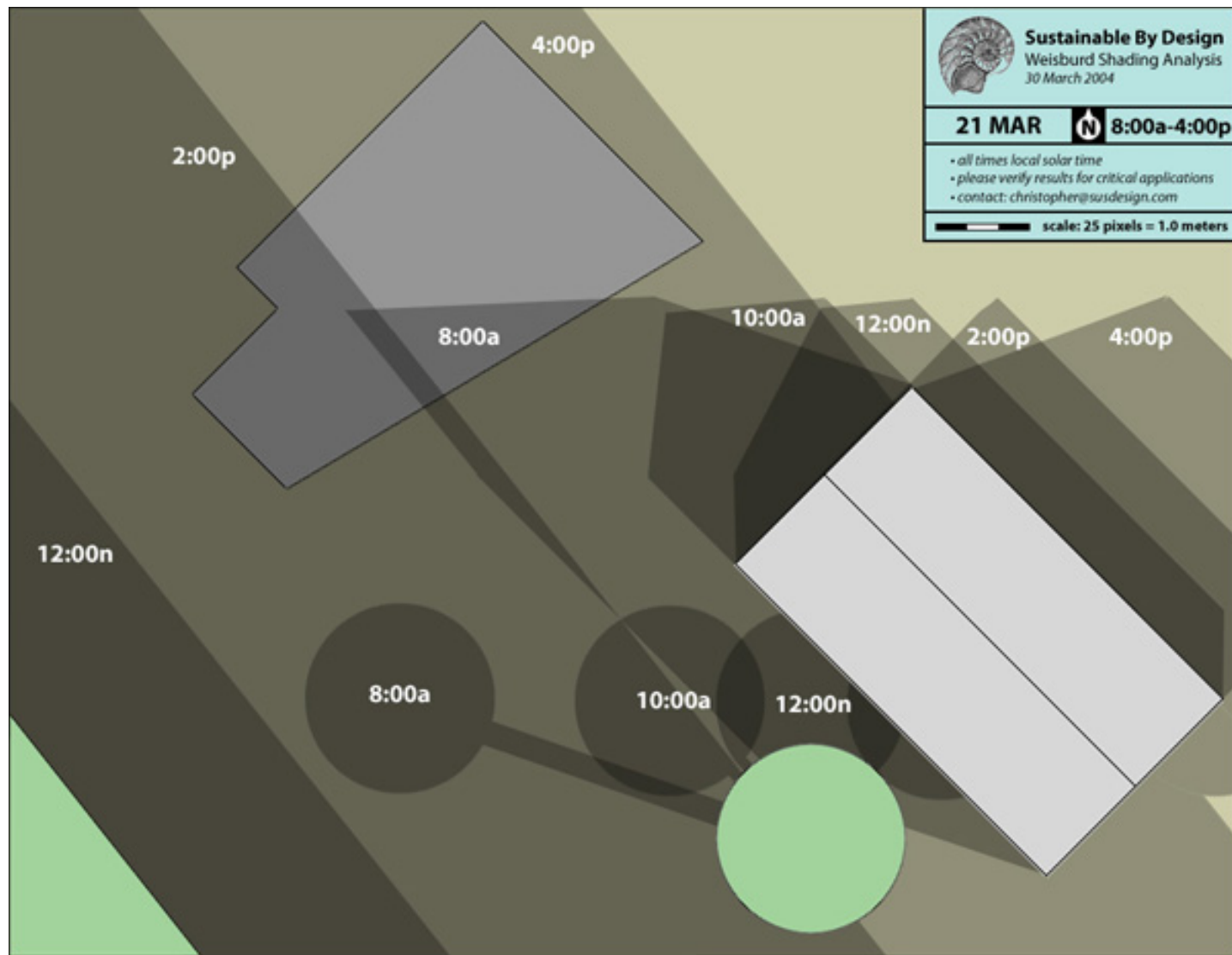

Plotting shadows allows you to understand your site and the effects of the sun on your site at different times of the day and year.



Shading analysis for Gary Johnson
Christopher Gronbeck, Sustainable By Design
christopher@susdesign.com · 206-372-4747
February 5, 2002 · Final, verified version

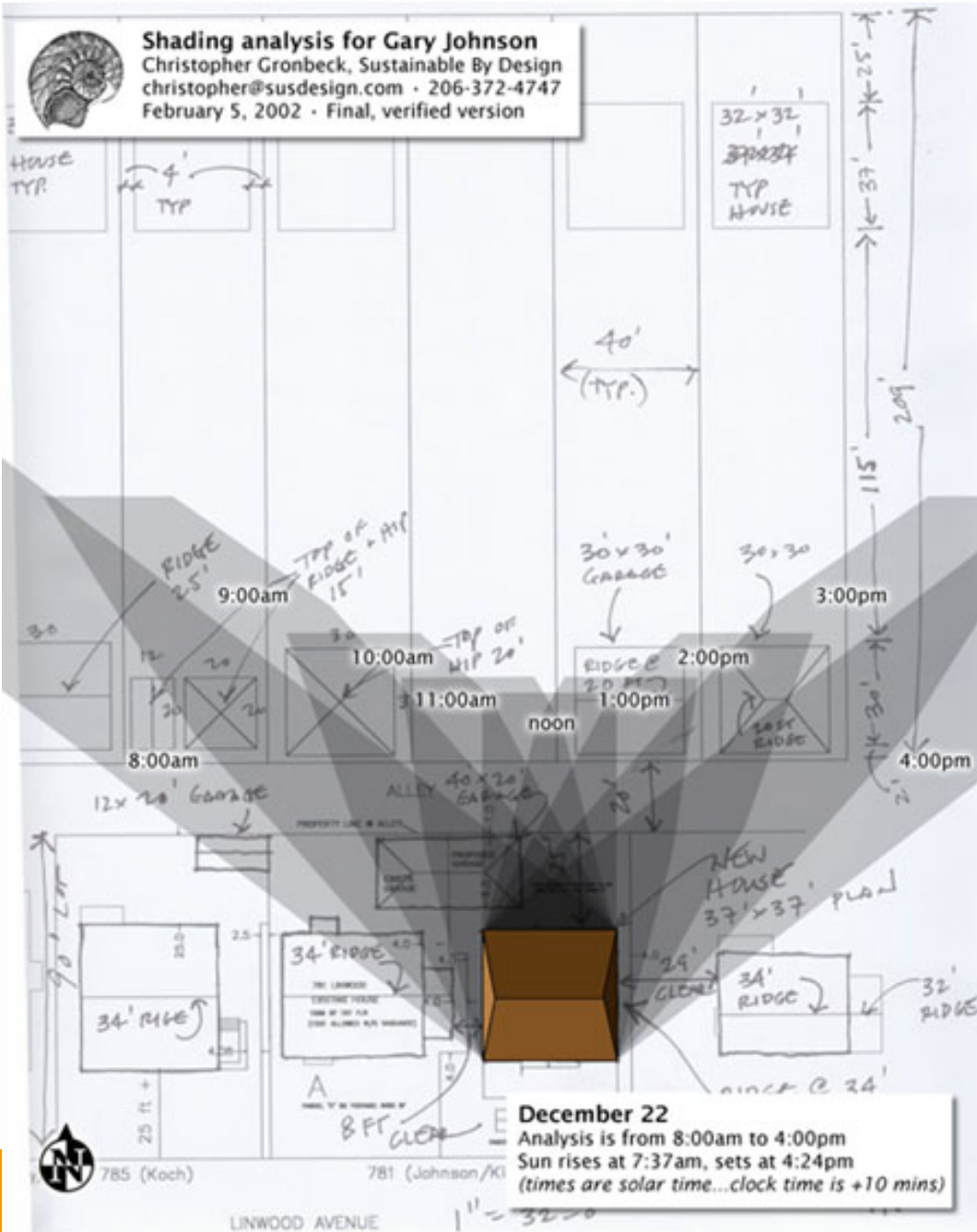

This type of analysis is a “must do” for every building that you design.

What is MISSING here, is the shading diagrams from the neighbouring properties (all sides). Their shadows will impact your building too.

Plotting shadows with these diagrams...

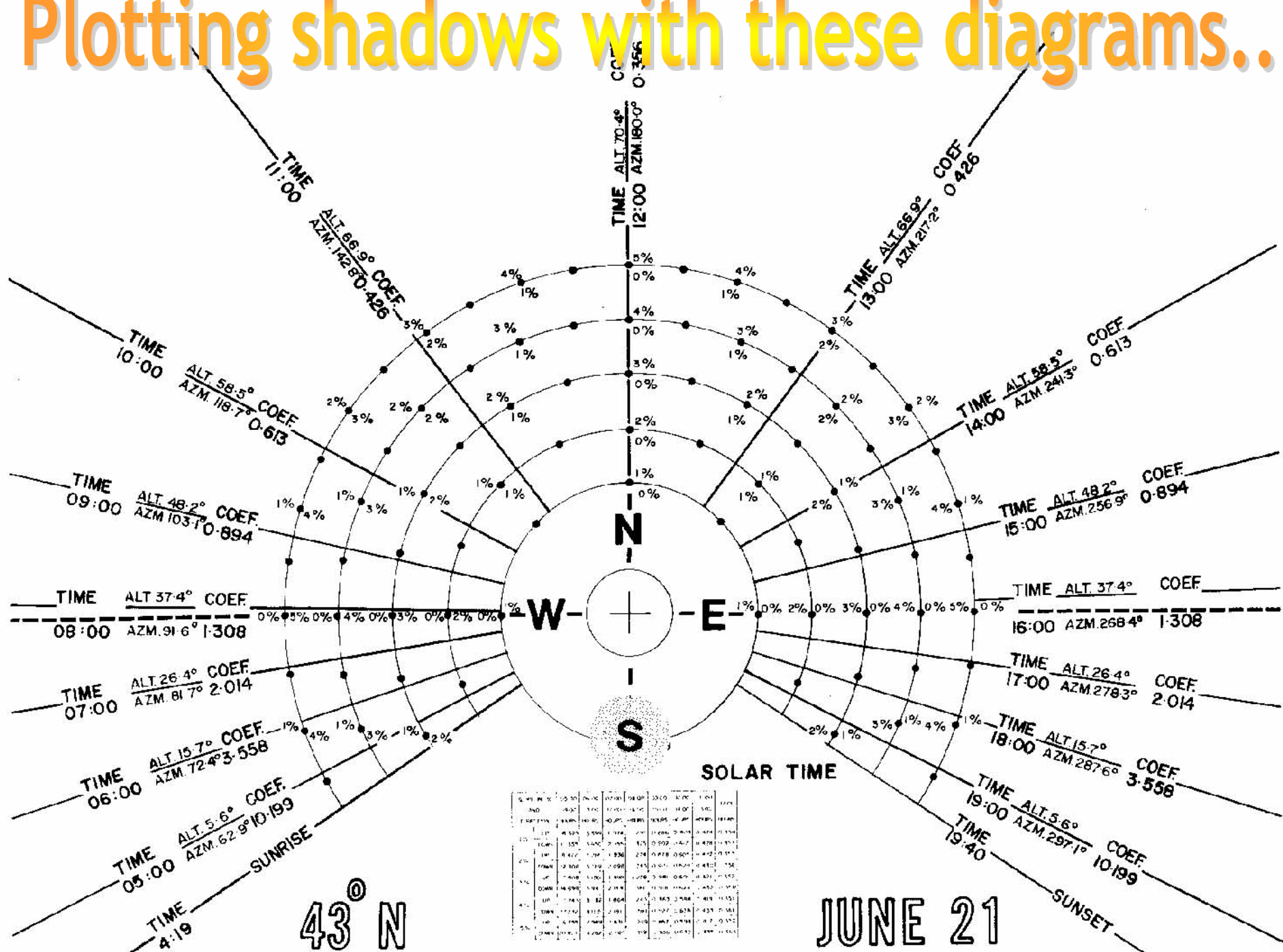

SHADOW LENGTH = HEIGHT x COEF. HEIGHT = SHADOW LENGTH ÷ COEF.

Shadow at 11 a.m. on June 21

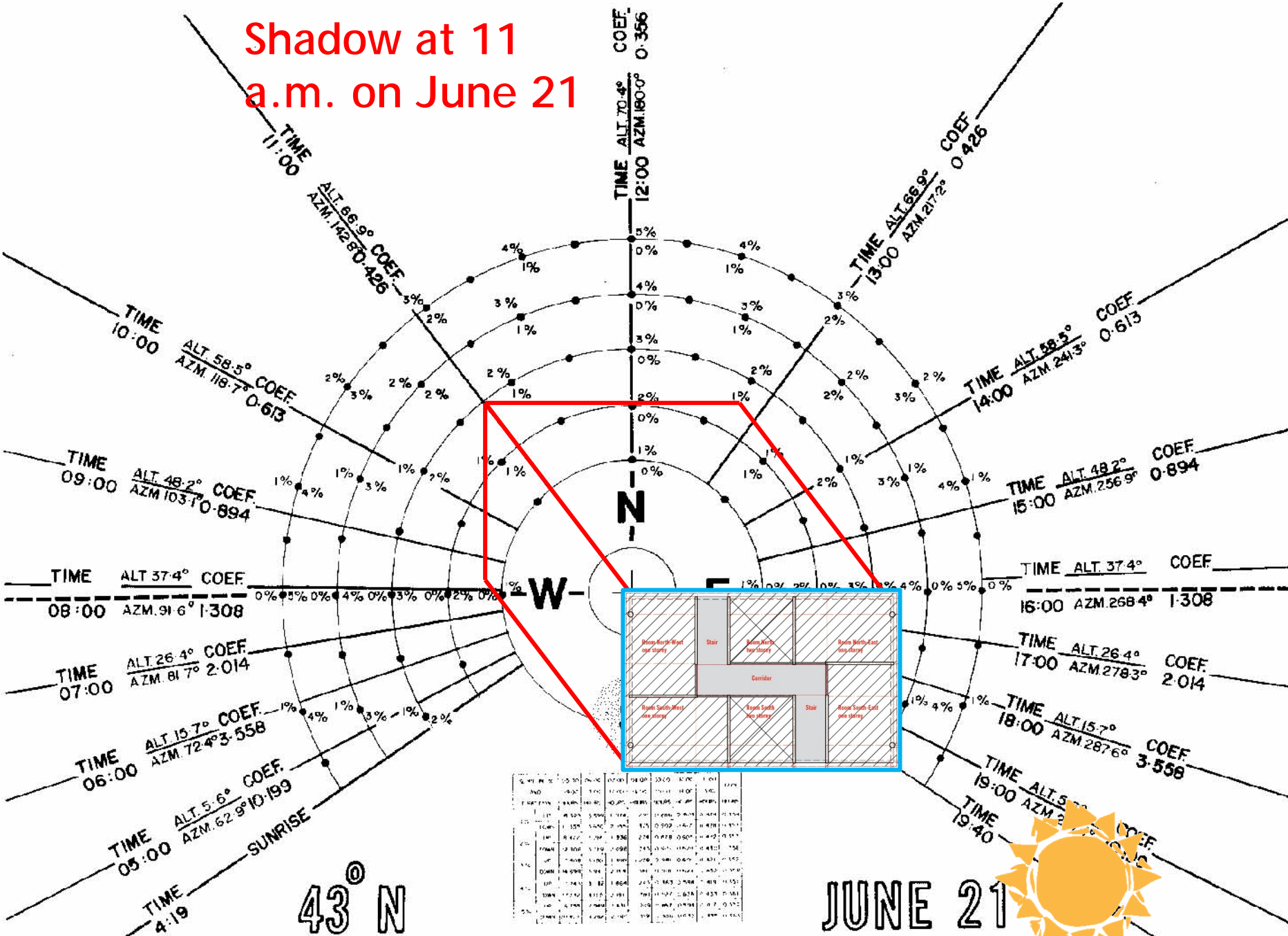

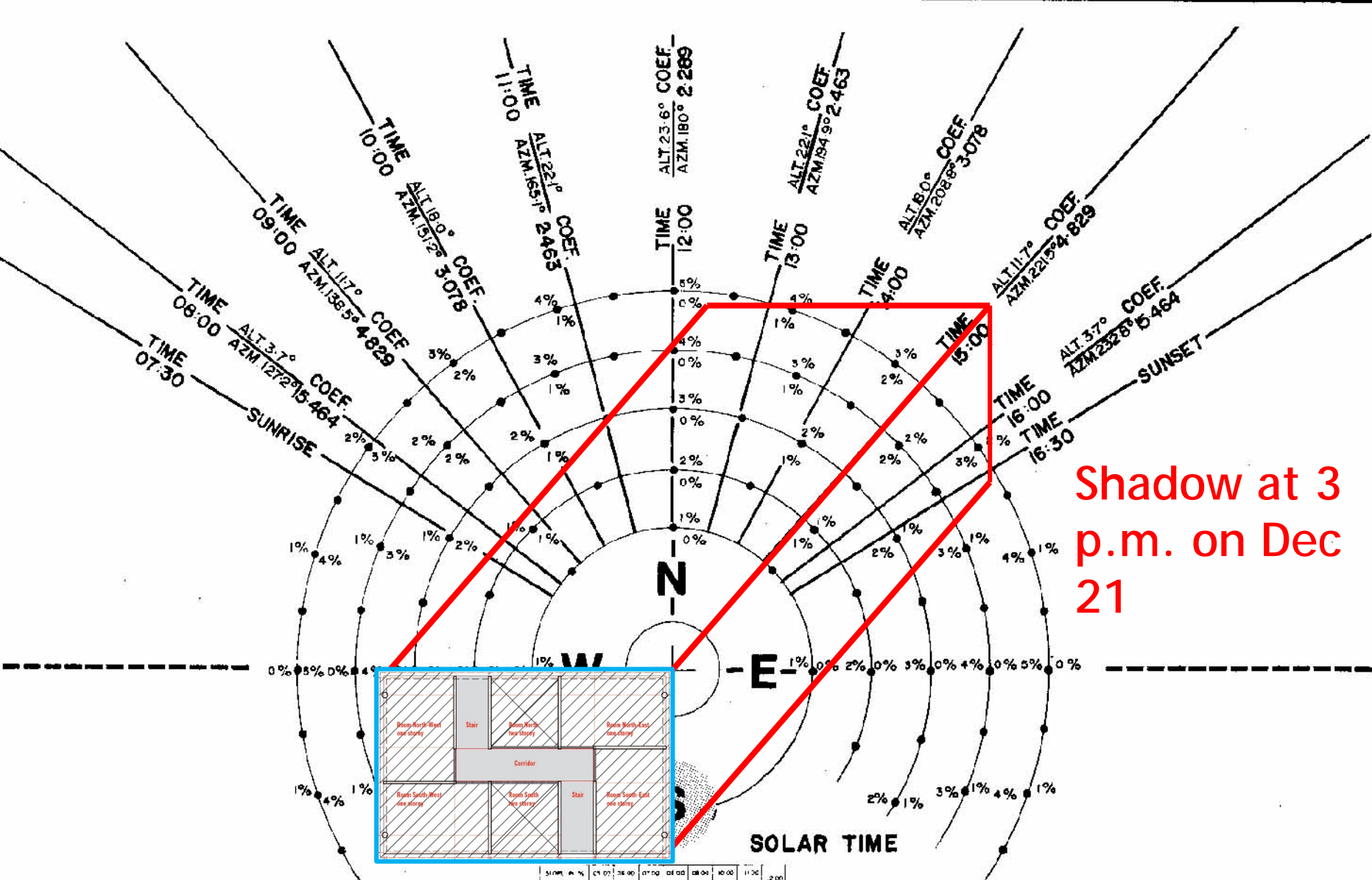

43° N

DEC. 21

SOLAR TIME	ALT	AZM	COEF	SHADOW LENGTH	SHADOW DIRECTION
07:30	3.7°	187.2°	15.464	1.0	15.464
08:00	3.7°	187.2°	15.464	1.0	15.464
09:00	11.2°	185.5°	4.829	0.88	165.0°
10:00	18.0°	184.9°	2.463	0.55	170.0°
11:00	22.1°	184.9°	2.463	0.45	175.0°
12:00	23.6°	180.0°	2.289	0.42	180.0°
13:00	22.1°	184.9°	2.463	0.45	185.0°
14:00	18.0°	208.6°	3.078	0.55	208.6°
15:00	11.7°	221.5°	4.829	0.88	221.5°
16:00	3.7°	232.8°	15.464	1.0	232.8°
16:30	3.7°	232.8°	15.464	1.0	232.8°

SHADOW LENGTH = HEIGHT x COEF.

HEIGHT = SHADOW LENGTH ÷ COEF.

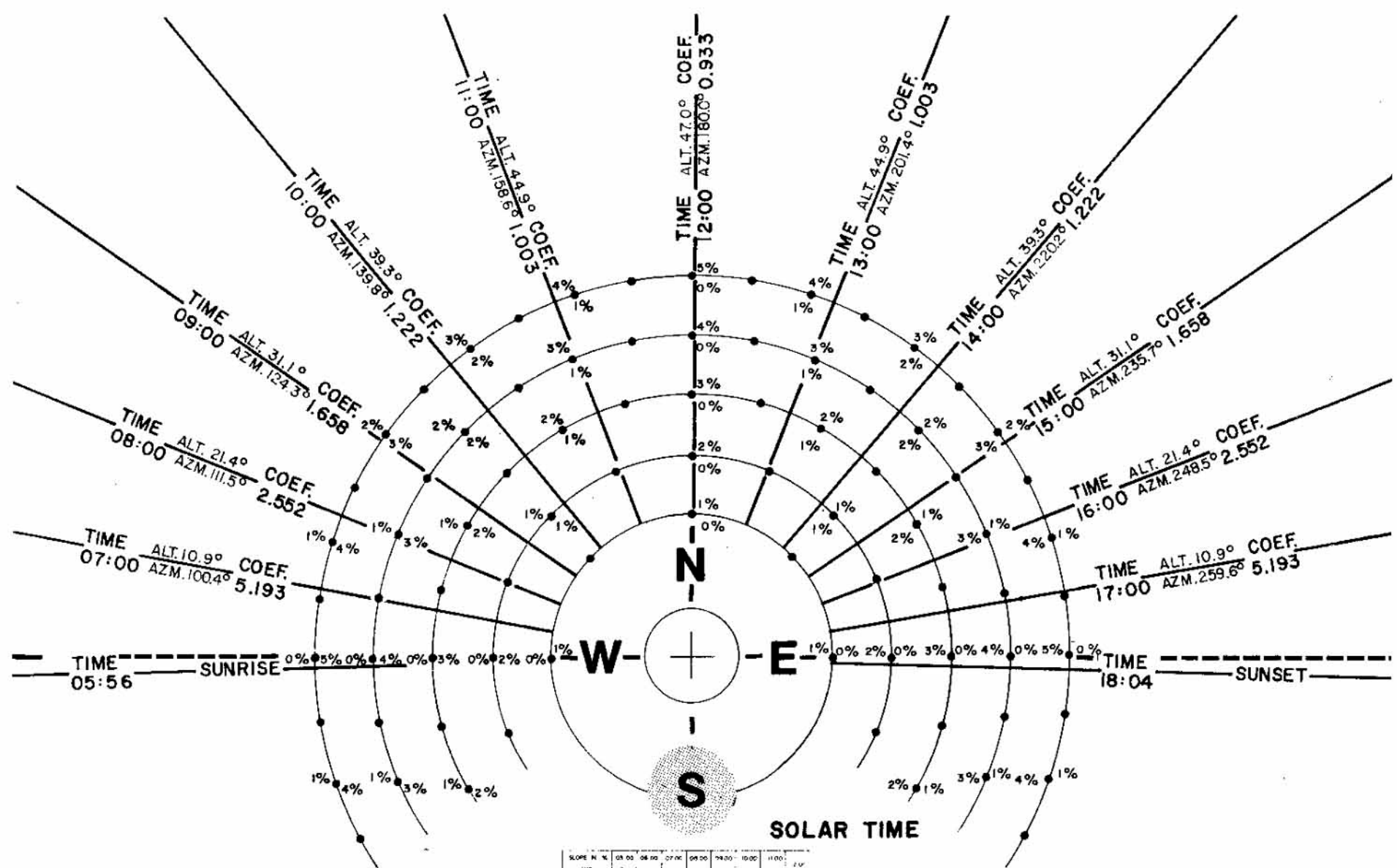

SOLAR TIME

43° N

MARCH 21

SLOPE IN %	03 00	04 00	05 00	06 00	07 00	08 00	09 00	10 00	11 00	2 1/2'
AND DIRECTION	19 00	19 30	20 00	20 30	21 00	21 30	22 00	22 30	23 00	HOURS
1% UP					4 316	2 886	1 610	1 207	0 916	0 724
DOWN					5 477	2 818	1 646	1 227	0 918	0 741
2% UP					4 704	2 826	1 675	1 193	0 883	0 715
DOWN					5 794	2 649	1 714	1 252	0 924	0 760
3% UP					4 493	2 170	1 579	1 119	0 874	0 707
DOWN					6 153	2 743	1 744	1 246	0 934	0 754
4% UP					4 284	2 225	1 554	1 164	0 845	0 693
DOWN					6 333	2 647	1 776	1 283	0 945	0 768
5% UP					4 171	2 221	1 530	1 152	0 830	0 681
DOWN					7 041	2 504	1 837	1 311	0 974	0 774

SHADOW LENGTH = HEIGHT x COEF.

HEIGHT = SHADOW LENGTH ÷ COEF.

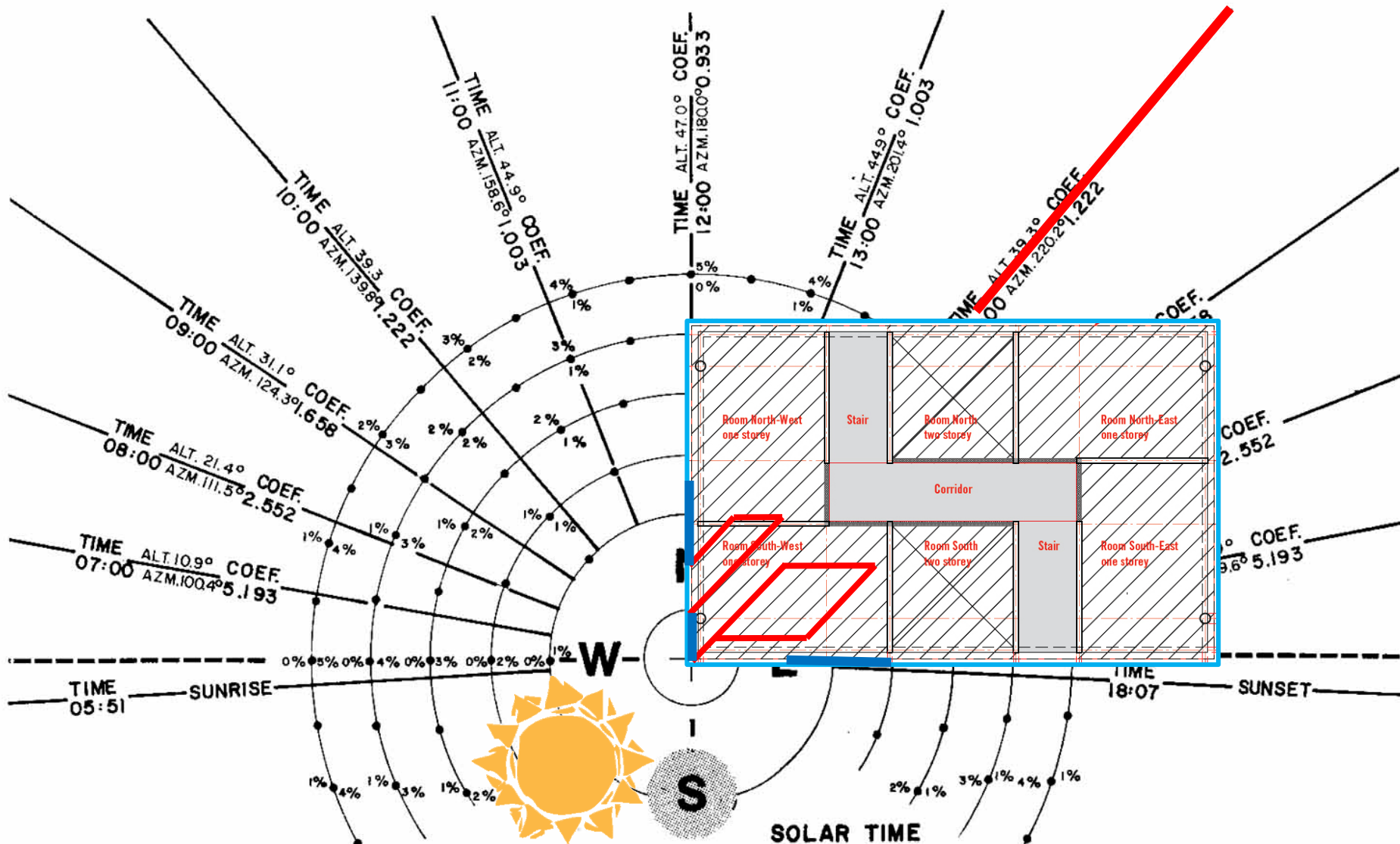

Notice that March 21 and Sept 21 are identical

43° N

SHADOW LENGTH = HEIGHT x COEF.

HEIGHT = SHADOW LENGTH ÷ COEF.

SLOPE IN °	AND DIRECTION	HOURS													
		05:00	06:00	07:00	08:00	09:00	10:00	11:00	12:00	13:00	14:00	15:00	16:00	17:00	18:00
1%	UP			4.936	2.888	1.831	1.077	0.692	0.441						
1%	DOWN			3.477	2.848	1.886	1.234	1.053	0.941						
3%	UP			4.704	2.487	1.608	1.022	0.682	0.415						
3%	DOWN			3.794	2.888	1.714	1.252	1.024	0.930						
5%	UP			5.482	2.170	1.578	1.178	0.874	0.607						
5%	DOWN			4.152	2.783	1.642	1.244	1.034	0.993						
7%	UP			6.266	2.313	1.555	1.185	0.864	0.609						
7%	DOWN			5.515	2.642	1.778	1.288	1.045	0.989						
9%	UP			7.121	2.383	1.531	1.132	0.850	0.601						
9%	DOWN			6.013	2.825	1.818	1.301	1.085	0.978						

SEPT. 21

Modelling with a Heliodon...

