

Arch 125: Environmental Building Design

Passive Design (Cooling)

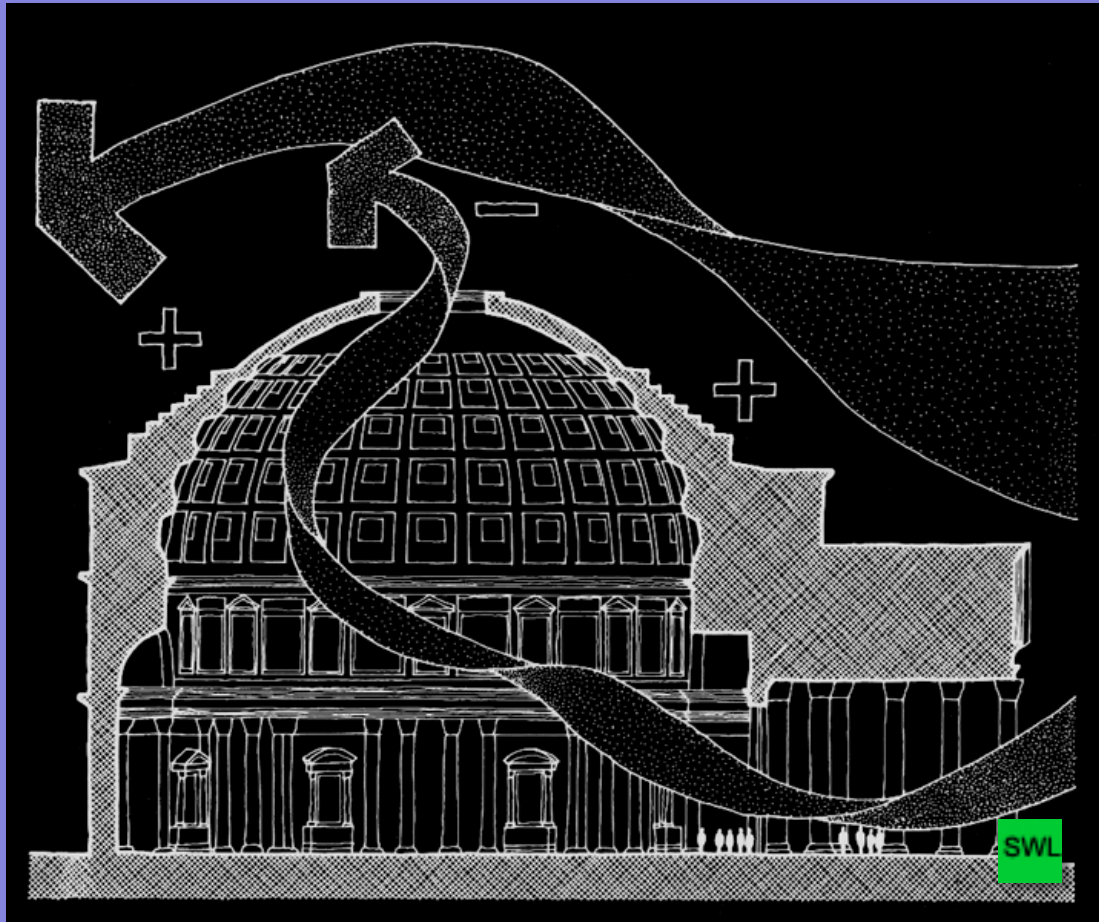

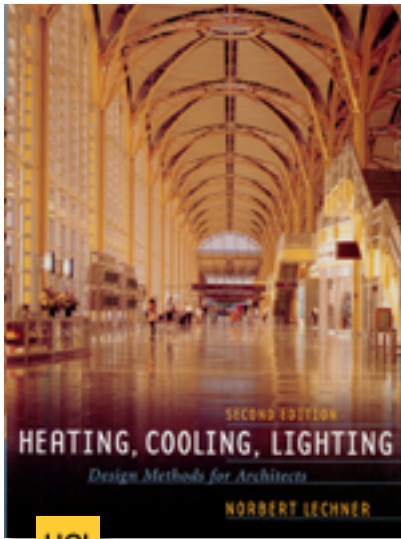

HCL



CBD



SWL



DWC



ECS

Texts used in the preparation of this presentation.



Chongqing,
China



Cairo,
Egypt



Simmons Hall, MIT - Stephen Holl



The tiered approach to reducing carbon for COOLING:

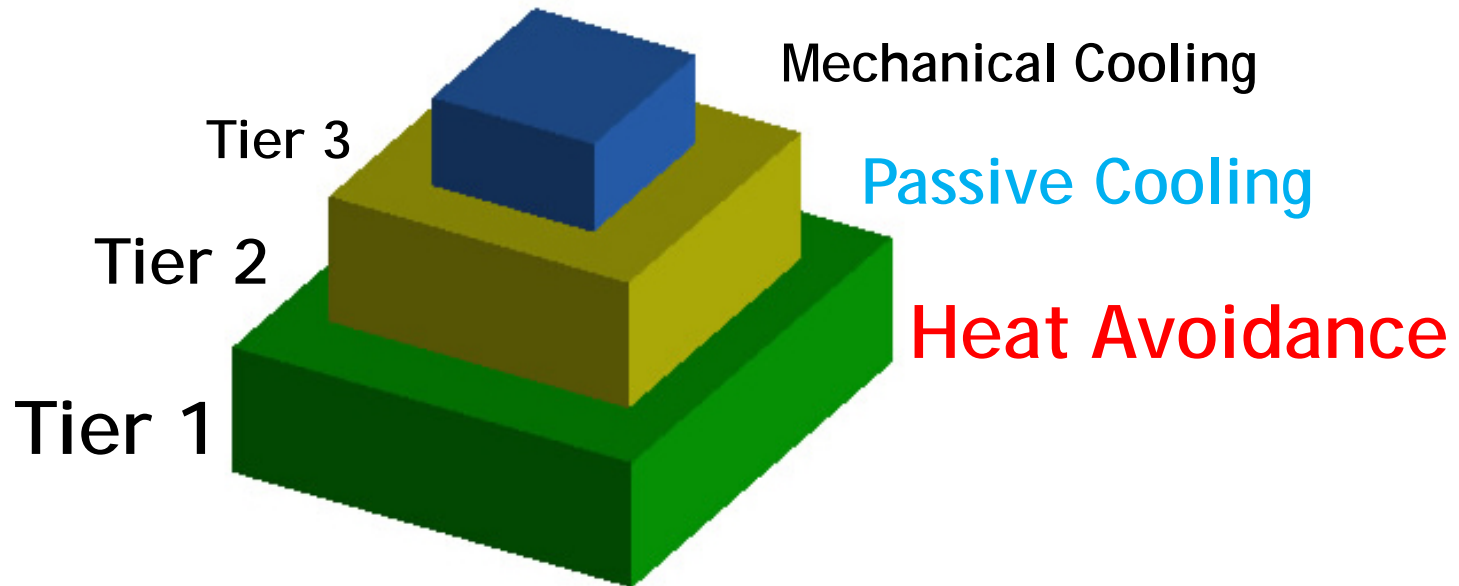

Maximize the amount of energy required for mechanical cooling that comes from renewable sources.

Source: Lechner. Heating, Cooling, Lighting.

Passive Cooling, General Principles:

Passive cooling is the counterpart of passive heating. While passive heating is driven only by the sun, passive cooling can use various heat sinks and climate influences to decrease heat.

1. Ventilative Cooling
2. Radiative Cooling
3. Evaporative Cooling
4. Dehumidification
5. Mass effect Cooling

Strategies for Summer Climate Control

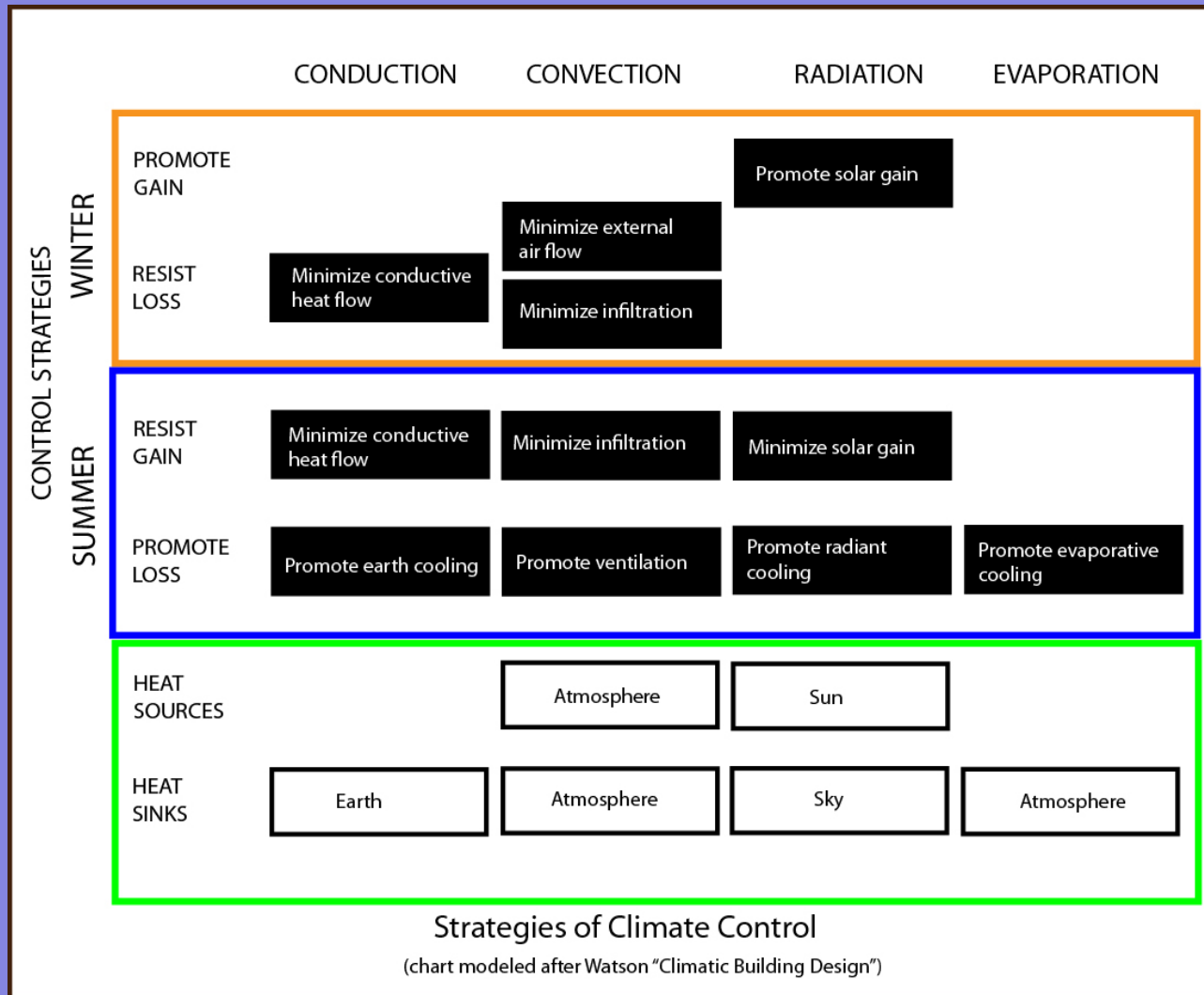

4 main strategy modes for PASSIVE COOLING design

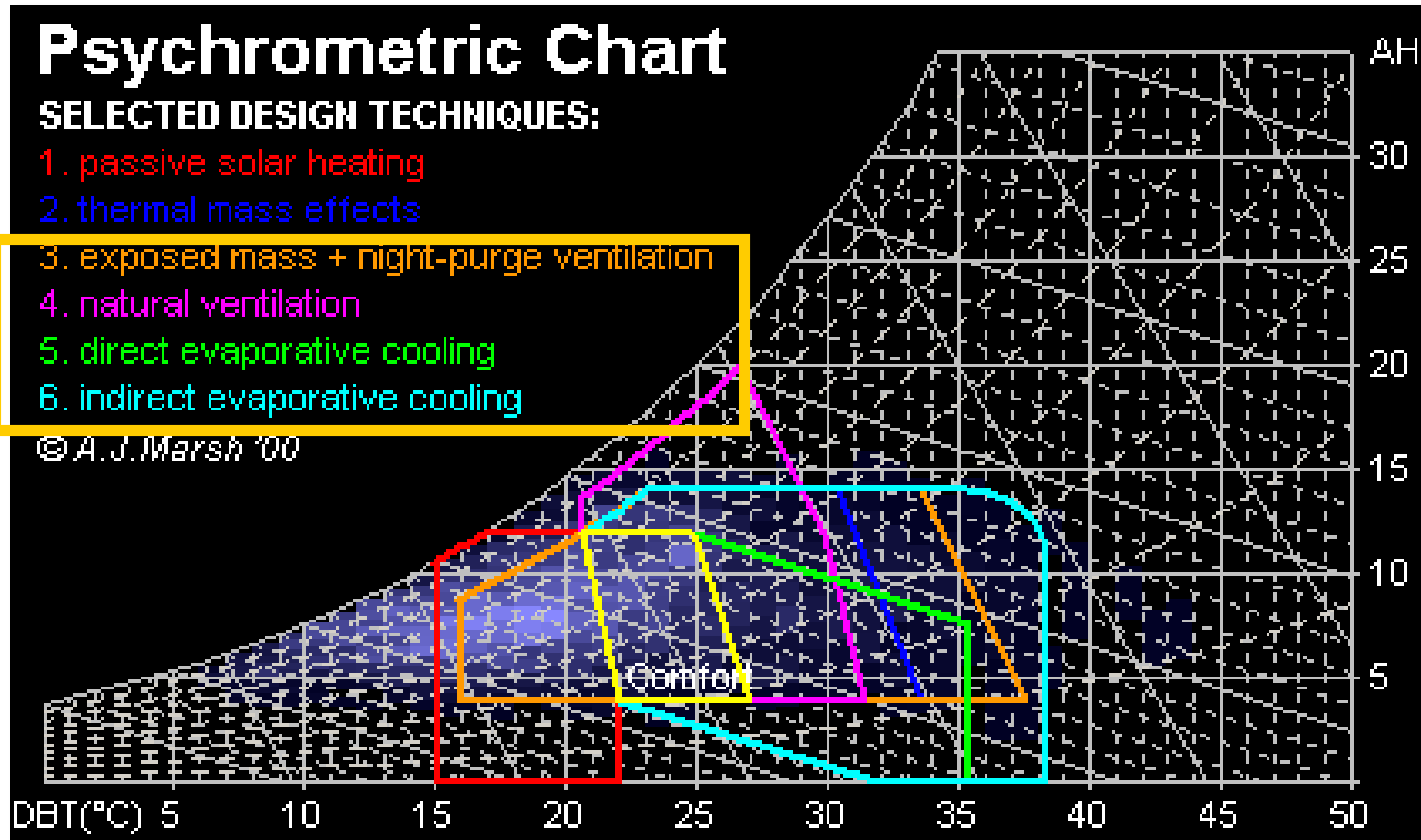

**But first,
think about**

Think Heat AVOIDANCE!

If it does not get IN, you don't have to deal with it!

One way to avoid heat gain is by modifying the glazing.

Atrium buildings have long had issues with solar gain, so some of the glass is opaque to give the appearance of "sky" without the solar gain.



Toronto, Eaton Centre - Zeidler Partnership



Salt Lake City Library, Moshe Safdie



Blinds must be manually drawn by the librarian every sunny day to avoid baking the children in the lower library area!



Shading is Heat AVOIDANCE!

Before resorting to expensive glass, think shading systems!





Shading systems need not be complex or highly technical!

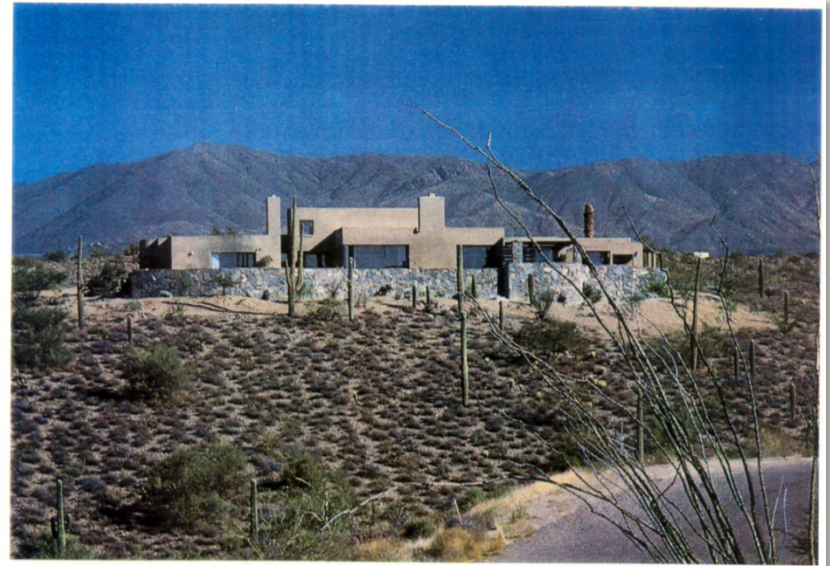

It is important to recognize that passive cooling is much more dependent on climate than passive heating. Thus the passive cooling strategies for **hot and dry** climates are very different from those for **hot and humid** climates.

Often the **temperate** climate is the hardest to design for to balance heating and cooling requirements as neither dominates for decision-making.



Hot arid climates use diurnal (day to night)
temperature variation and avoid heat gain
AND natural ventilation!





Hot humid climates count on natural ventilation and light weight materials as the day to night temperature variation is minimal.



Seattle City Hall

Temperate and cold climate buildings must hit the middle ground as not to compromise their more dominant heating season passive gain strategies.

Phoenix Public Library

OK, we have maxxed out on Heat
Avoidance...

Now what??



Passive Cooling: What is it?

As much as possible, passive cooling uses **natural forces, energies, and heat sinks**.

Since the goal is to create thermal comfort during the summer (the over-heated period), we can either :

1. **cool the building** by **removing heat** from the building by finding a heat sink
2. **raise the comfort zone** sufficiently to include the high indoor temperature by **increasing the air velocity** so that the comfort zone shifts to higher temperatures.

Passive Cooling: How do we do it?

Passive cooling relies on two primary strategies:

1. First and foremost, HEAT AVOIDANCE, **prevent heat from getting into the building!** If it does not come in, we don't need to get rid of it.
 - use **shading devices**
 - create a **cool microclimate** to discourage heat buildup
2. **Get rid of unwanted heat** that comes into the building
 - in cold and temperate climate, mainly via ventilation

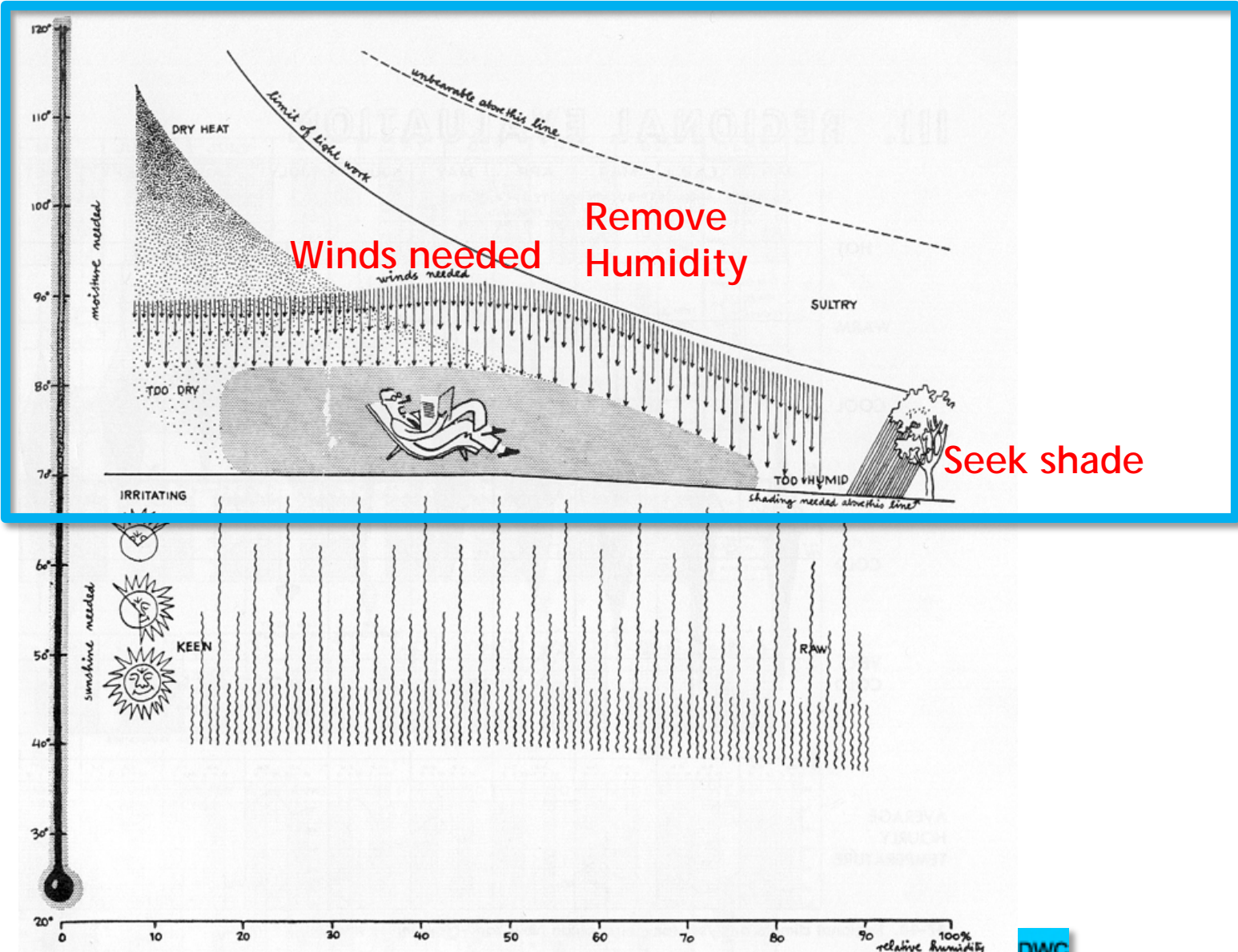

46. Schematic bioclimatic index.

Cooling thru microclimate and shading:

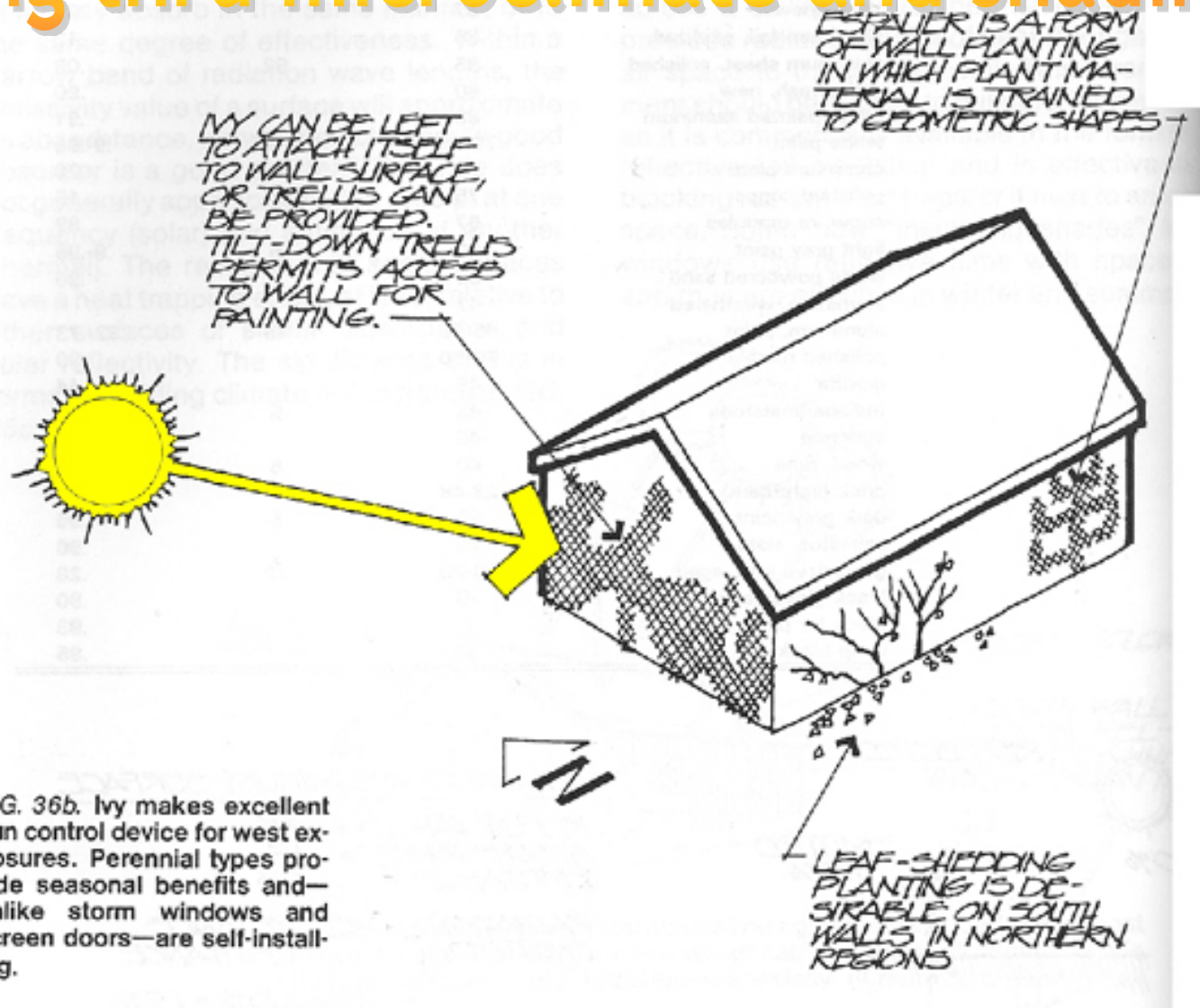

Cooling thru microclimate and shading:

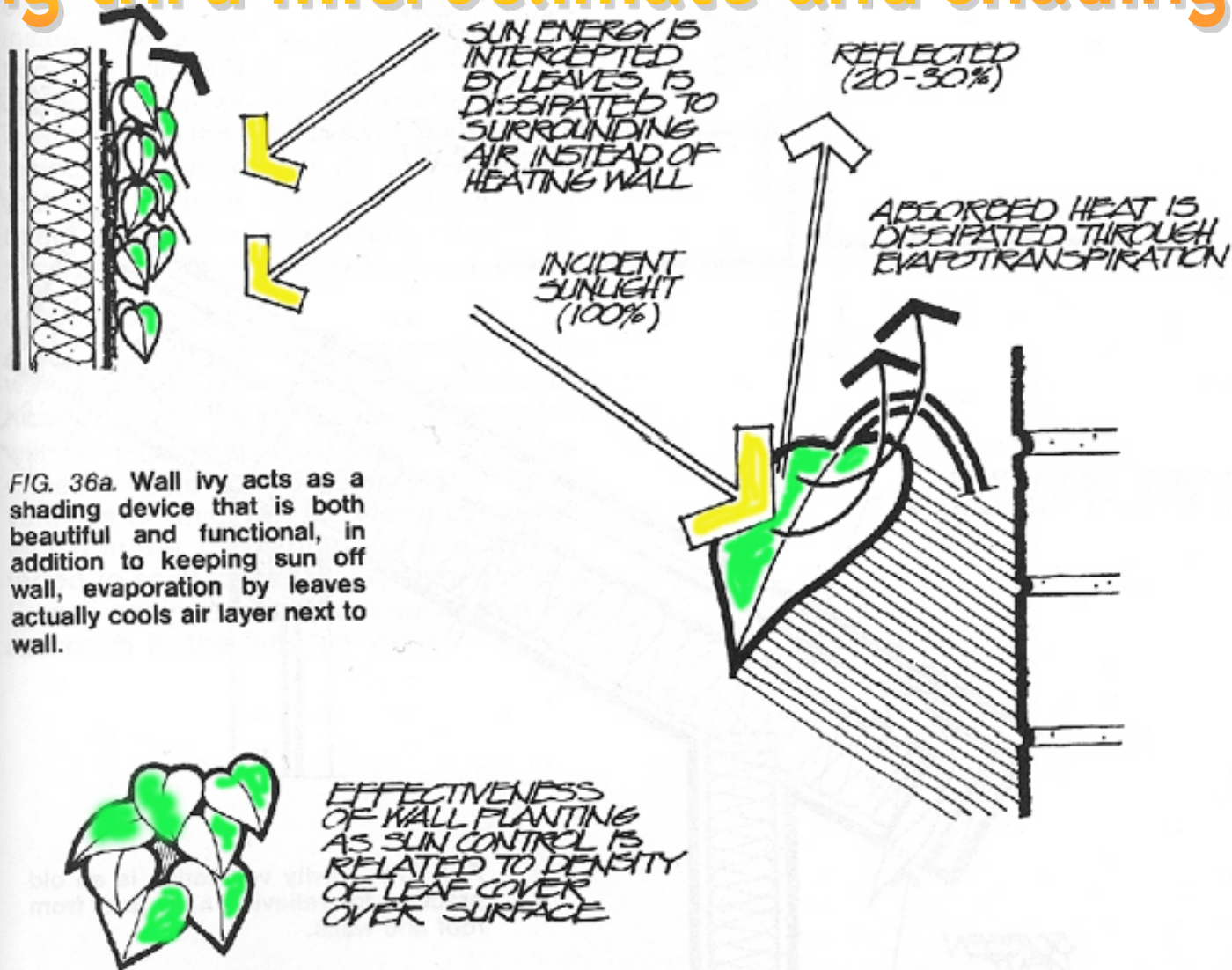



Cooling thru microclimate and shading:

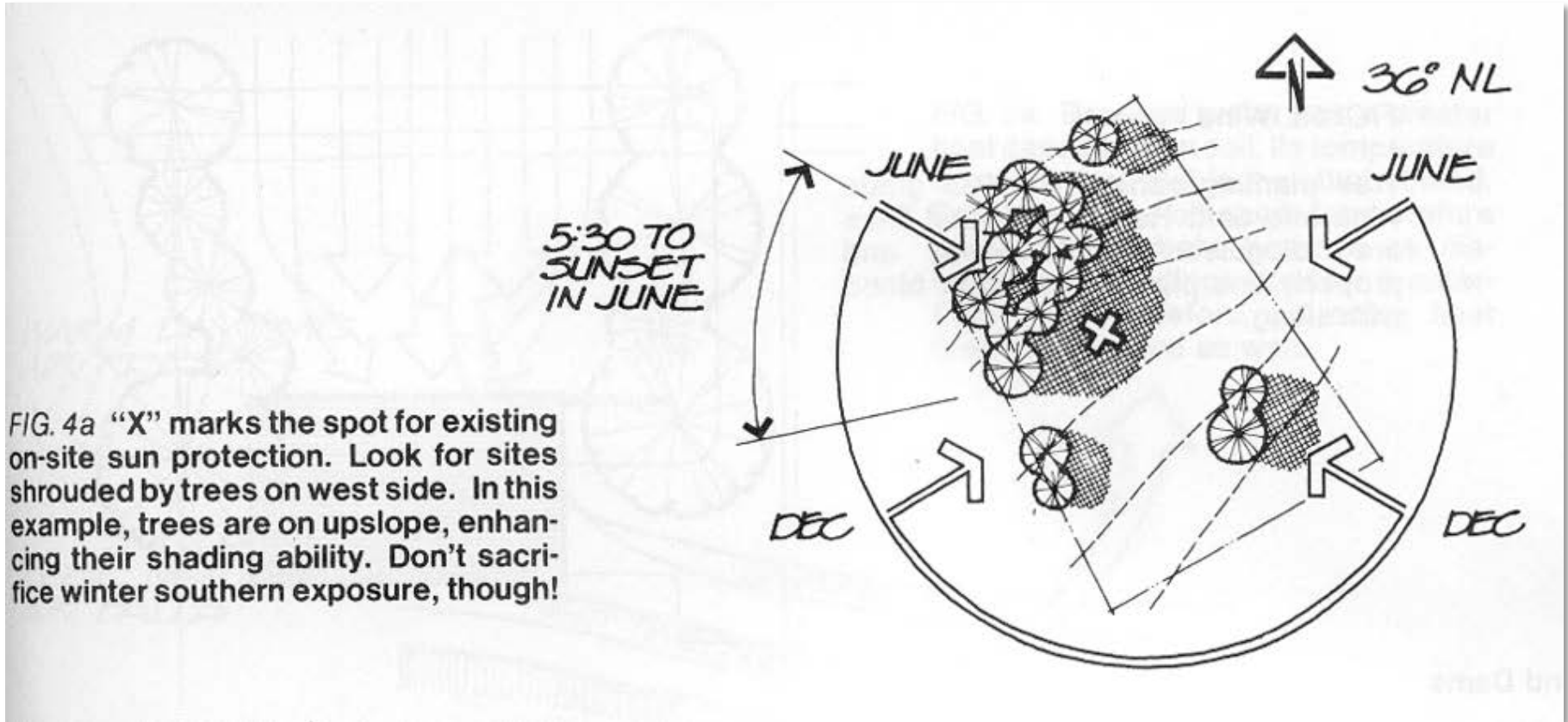
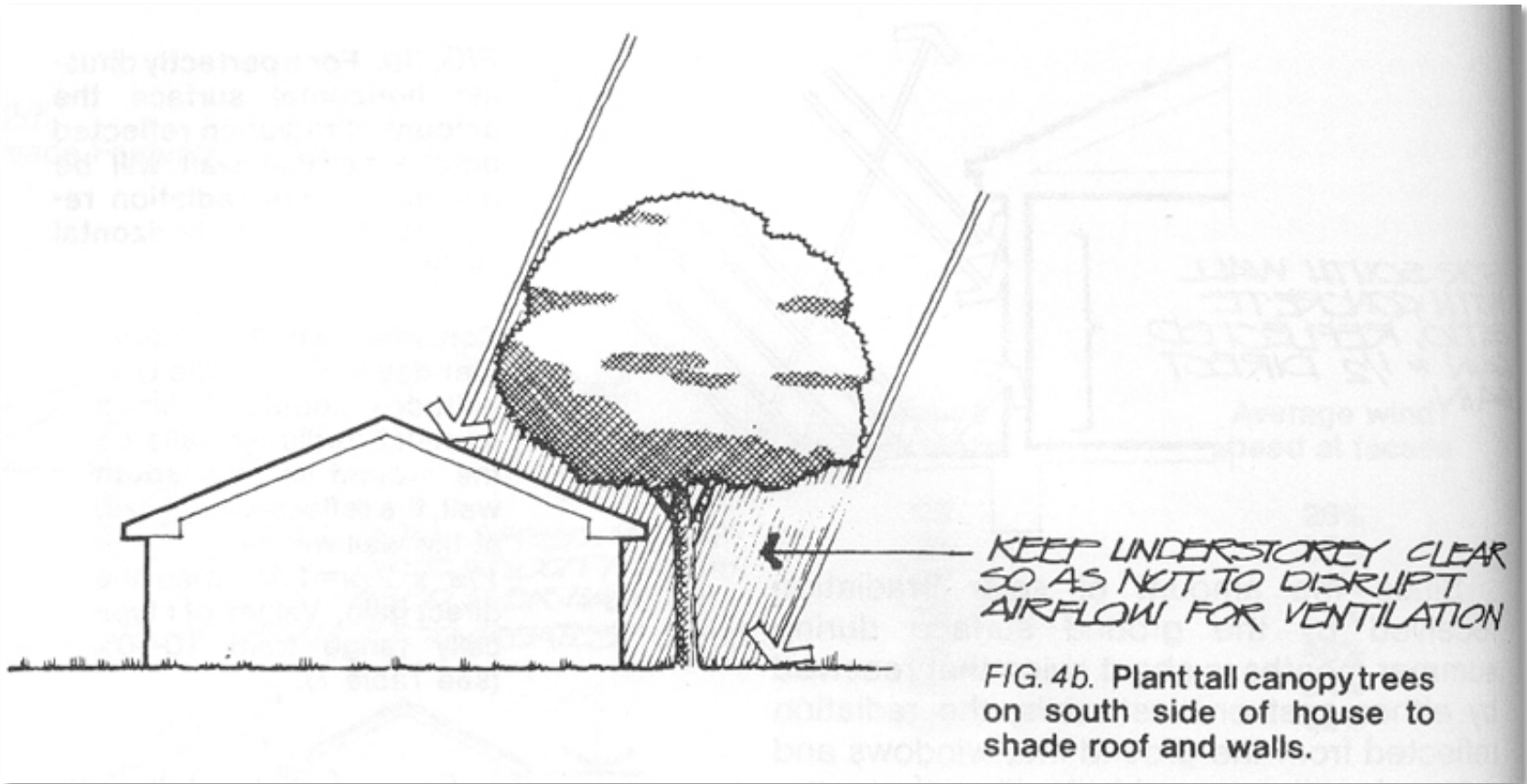

FIG. 4a "X" marks the spot for existing on-site sun protection. Look for sites shrouded by trees on west side. In this example, trees are on upslope, enhancing their shading ability. Don't sacrifice winter southern exposure, though!



Massey College, Ron Thom Architect,
University of Toronto

Cooling thru microclimate and shading:



CBD

Trees planted close to the building on the south side can shade the walls and roof.

Cooling thru microclimate and shading:

SHADE PLANTING ON WEST AND NORTHWEST SIDES OFTEN CAN DOUBLE AS WINTER WIND-BREAK. CONSIDER EVERGREENS, FENCES, AND WALLS.

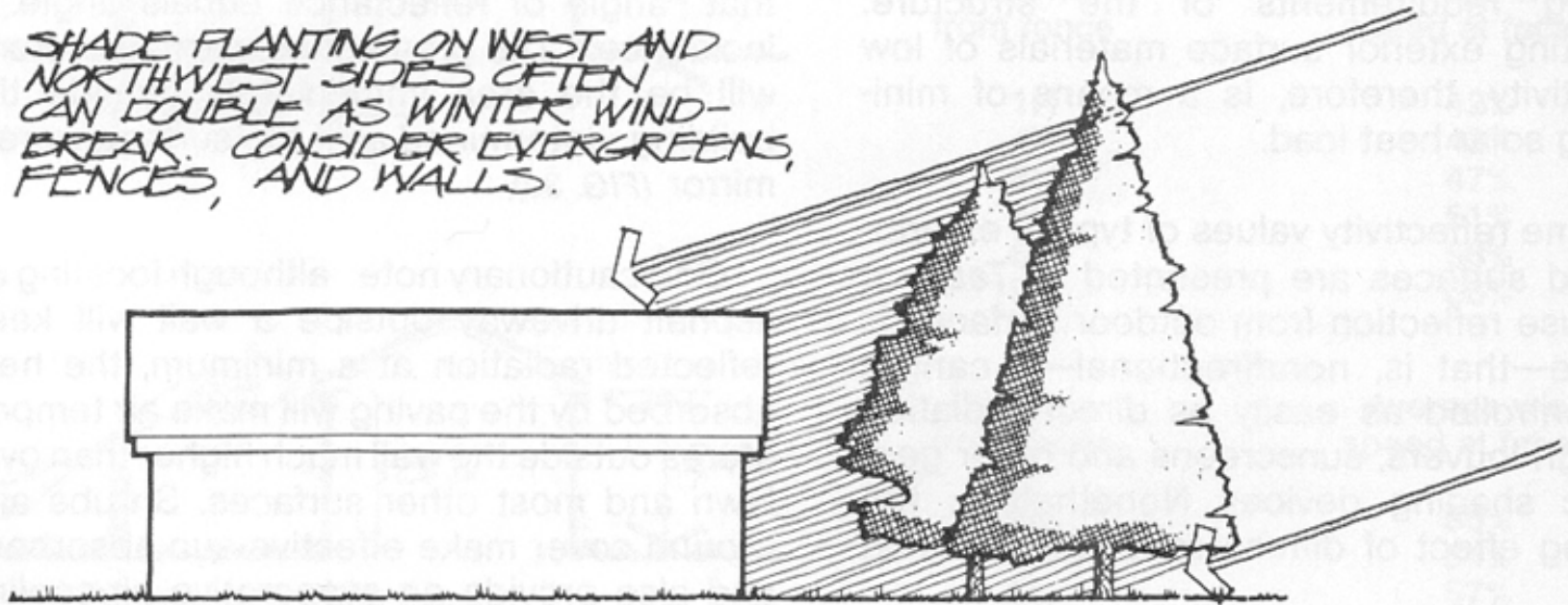

FIG. 4c. Plant dense trees, shrubs, hedges on west side of house to intercept afternoon sun.

Trees on the west and east sides can block low sunlight in the morning and afternoon.



Exterior shading like this
cools the microclimate.
More on this later!

Cooling thru microclimate and shading:

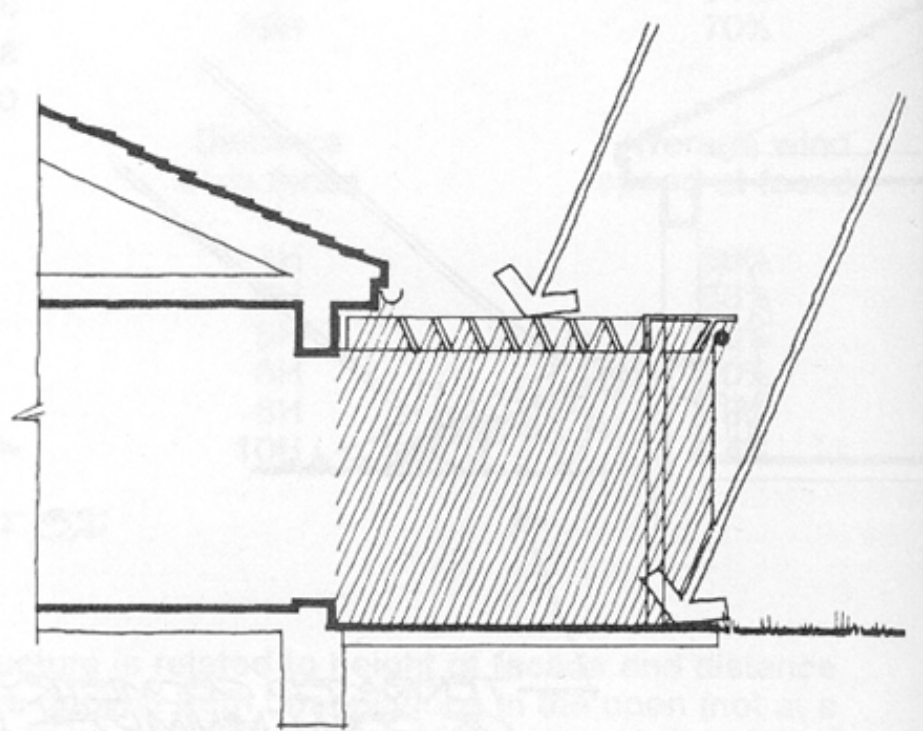

FIG. 4d. Attached overhead shading structures can provide multiple benefits. Not only does this patio cover shade the wall, it also reduces reflected gain from loading on the wall.

CBD

Trellises can provide shade to the building and outdoor rooms.





DESIGNING AND BUILDING IN THE TROPICS

BRUNO STAGNO- ARCHITECT COSTA RICA

stagno@racsa.co.cr

tel.(506) 233 9084

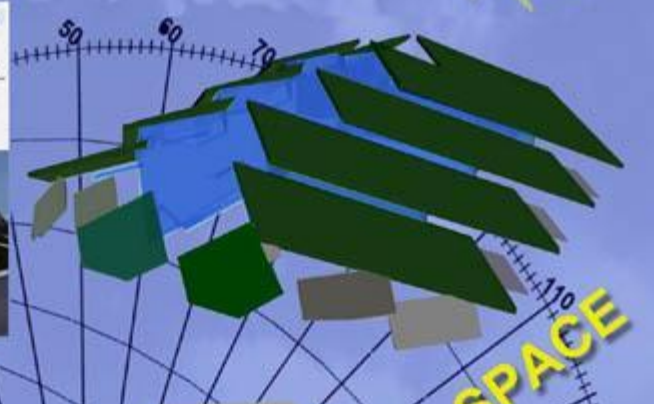

GREEN



ArchitectureWeek.com

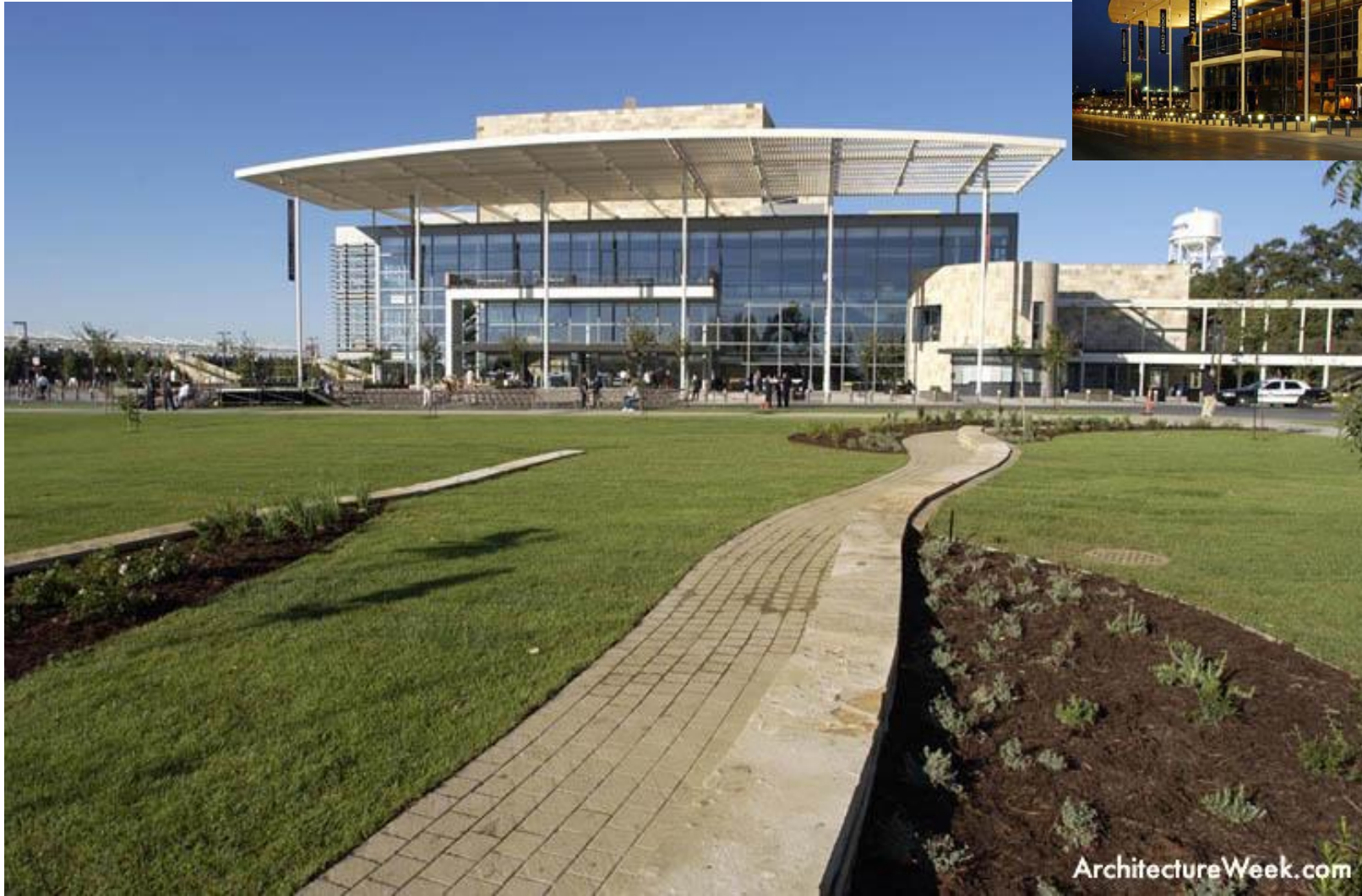



ArchitectureWeek.com



St. John Ambulance Headquarters, Edmonton, Manasc Isaac Architects



Watch for
falling ice if
you dare sit
on those
benches!



Office building in Des Moines, Murphy and Associates





Stratus Vineyards, Niagara-on-the-Lake





What is Ventilative Cooling??

1. Exhausting warm building air and replacing it with cooler outside air
2. Directing moving air across occupants' skin to create convection and evaporation
3. Achieved by the wind, **stack effect** or fans.

You have to not only provide openings but also, locate them correctly, make sure they are large enough, for this to work properly!!

Figure 10.5a Air flows either because of natural convection or because of pressure differentials.

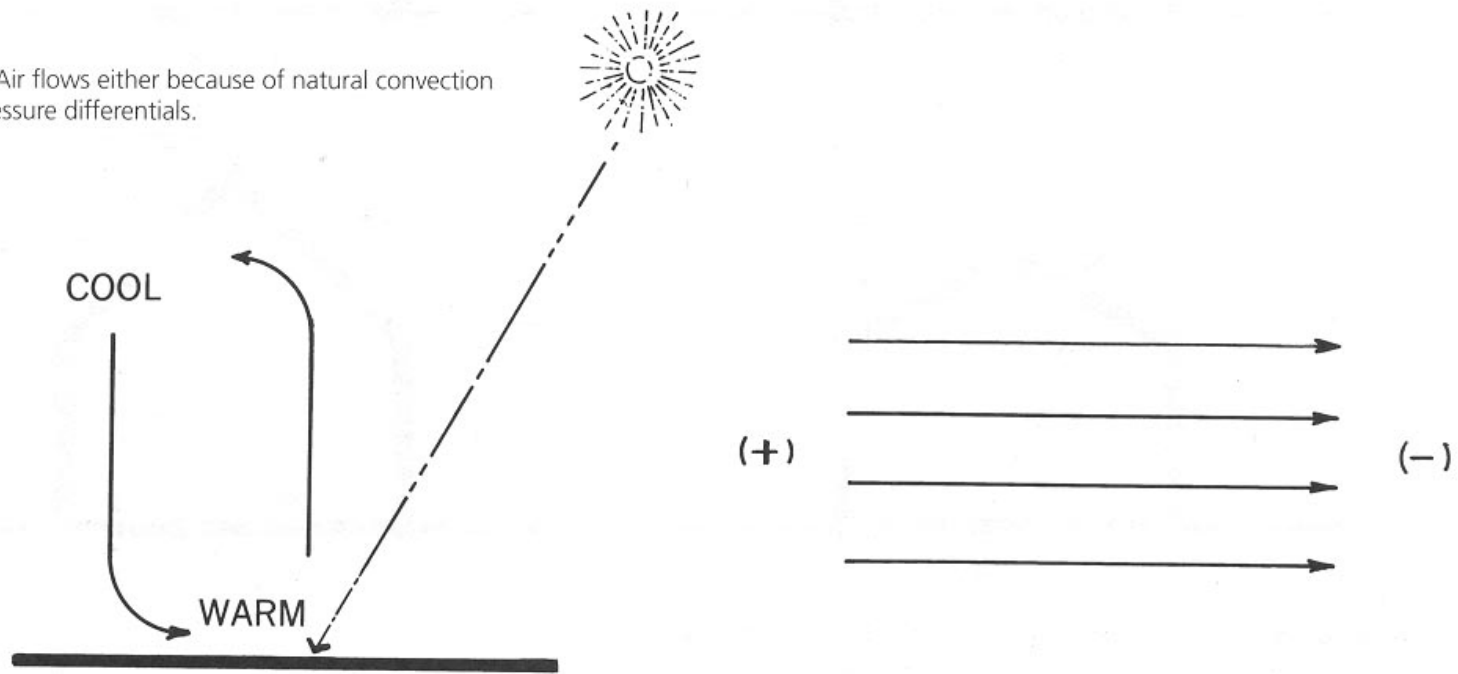

Reason for the air to flow:

1. **Natural convection** currents caused by differences in temperature
2. **Differences in pressure**

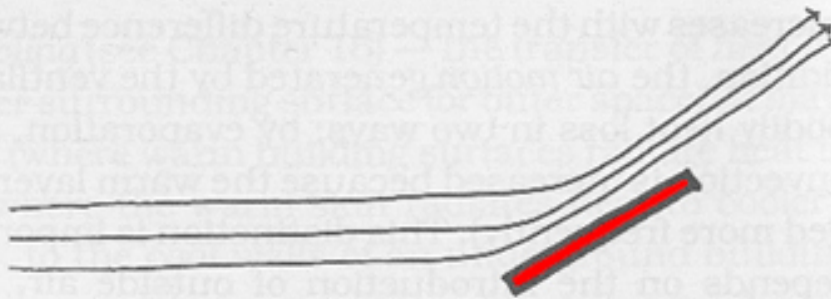

Figure 15.4: Ventilation principle #2 — Air has mass (and thus momentum) and it will tend to continue in its direction until altered by an obstruction or adjacent airflow.

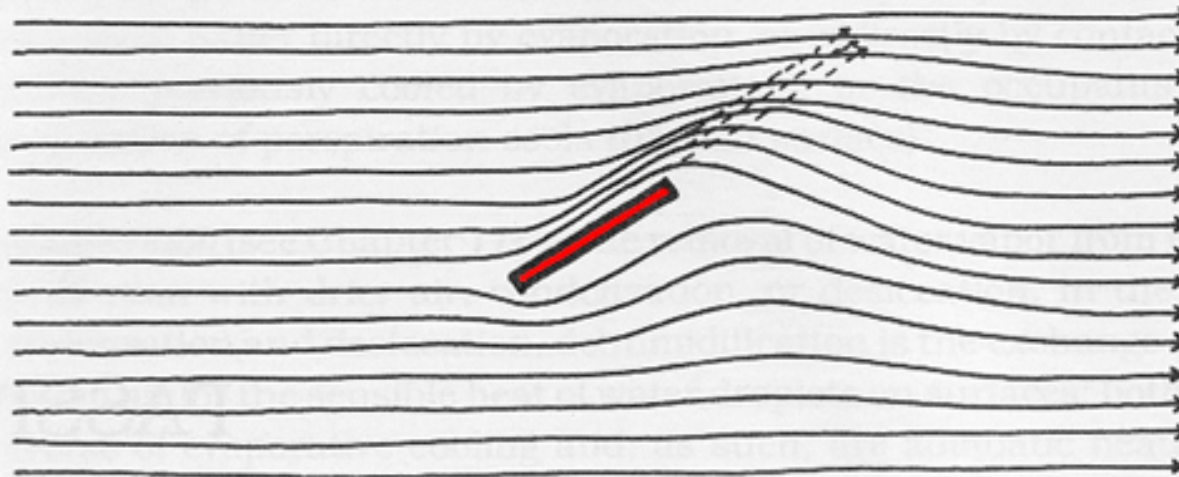

Figure 15.5: Ventilation principle #3 — The overall effect of wind at a site is so large that locally deflected airflow (by trees or buildings, for example) will tend to return to the direction and speed of the site wind.

and walls) is an example of daily-cycle mass-effect cooling.

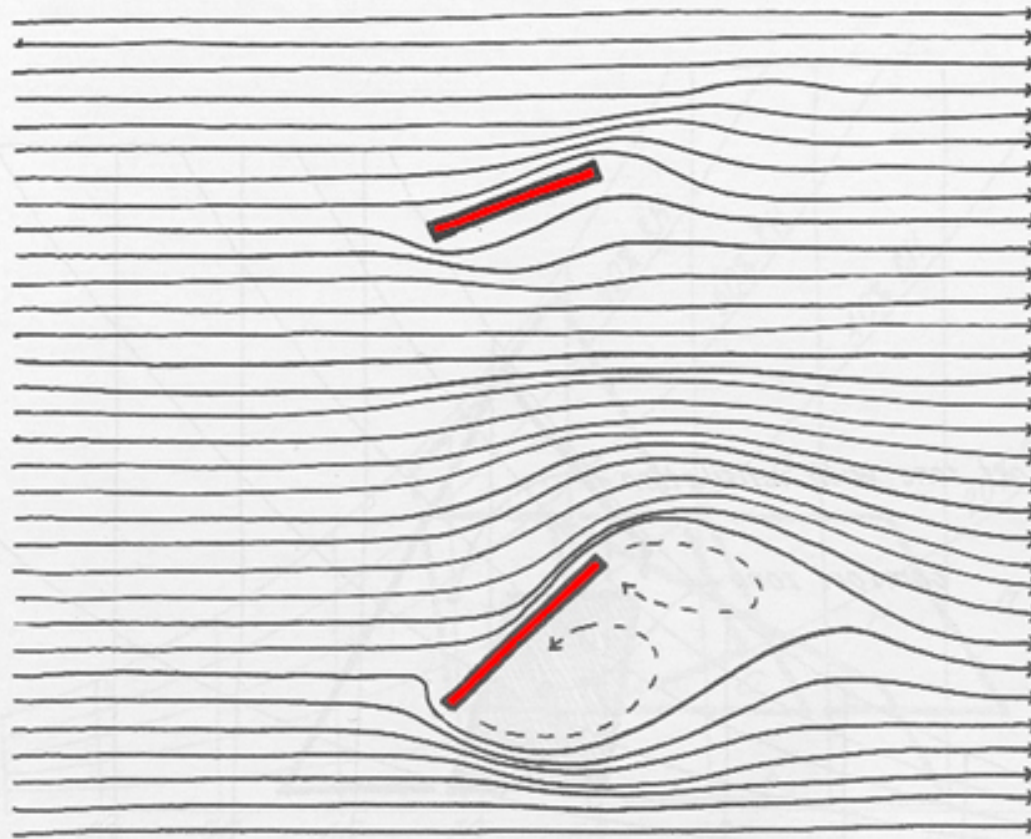

Figure 15.6: Ventilation principle #4 — “Laminar” airflow is smooth with adjacent air moving in similar direction and speed. Slow, gentle alterations of flow direction will preserve laminar flow, while abrupt alterations results in “turbulent flow” whereby adjacent air currents separate abruptly into swirling, unpredictable directions. When two currents of air are traveling in opposite directions, they will always be separated by eddies because adjacent particles of air always move in the same direction.

How does ventilation work?

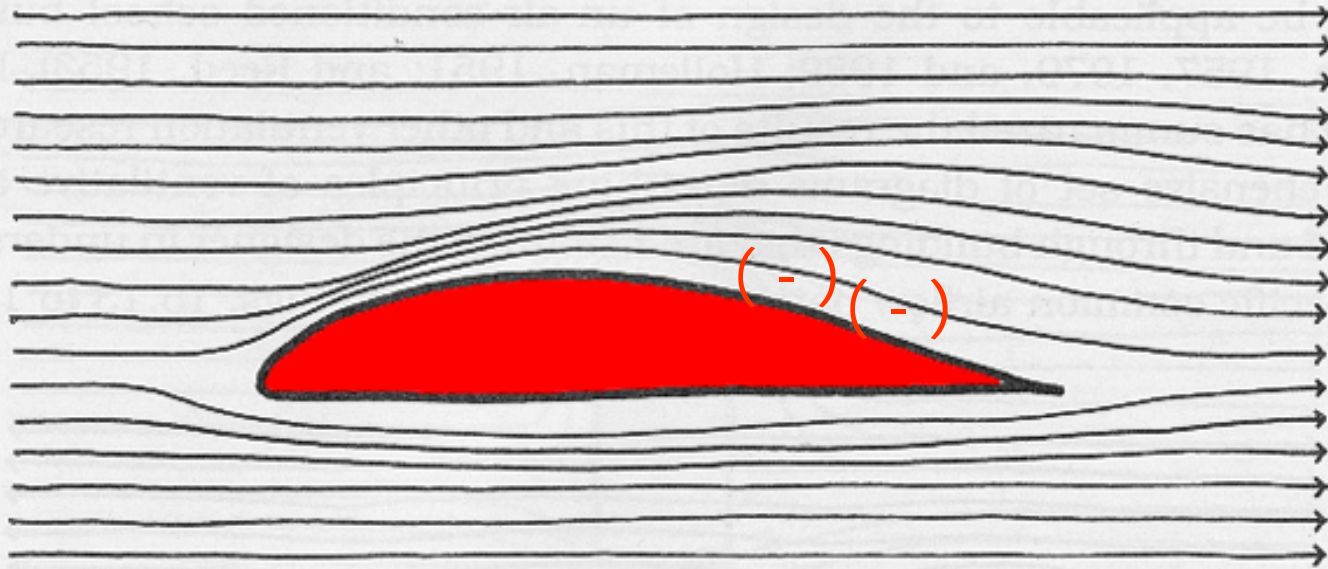

Figure 15.7: Ventilation principle #5 — The “Bernoulli effect” causes a decrease in pressure when air is accelerated in order to cover a greater distance than adjacent airflow. The classic example is the airplane wing which is shaped so that air passing over the top must travel further than that passing below; the Bernoulli effect reduces pressure on the top of the wing as the air is accelerated, creating “lift.”

Ventilation:

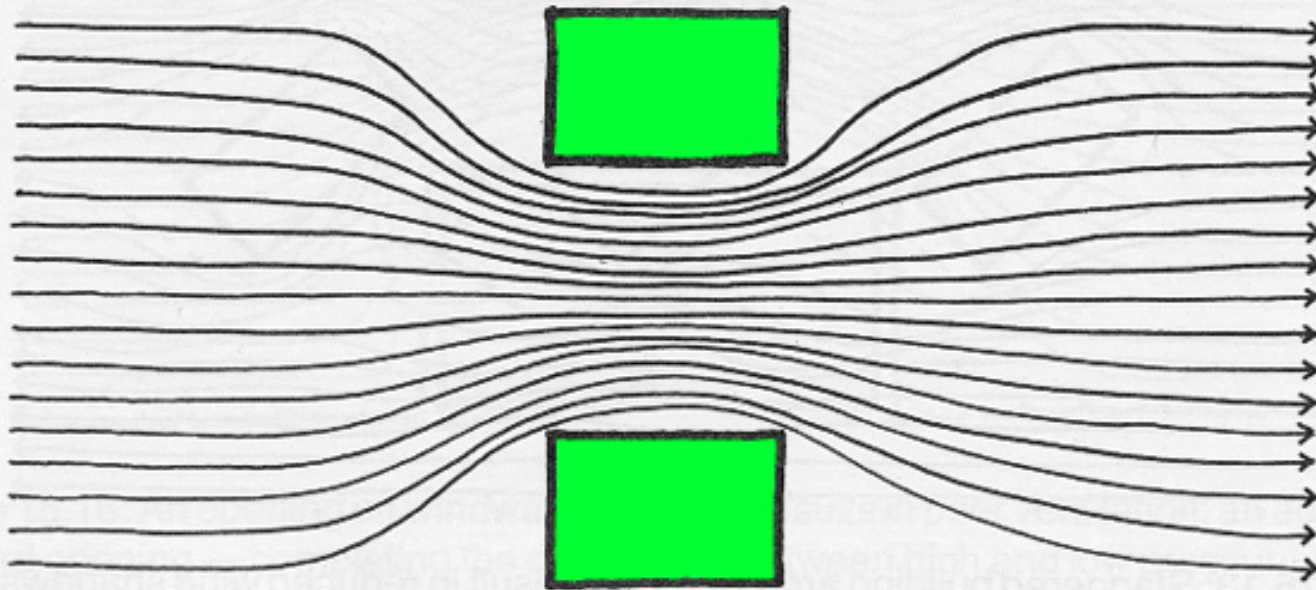

Figure 15.8: Ventilation principle #6 — The “Venturi effect” causes an acceleration when laminar airflow is constricted in order to pass through an opening (because the same volume of air must now pass through a smaller area). If the constriction is so abrupt as to create turbulence, Venturi acceleration is minimized.

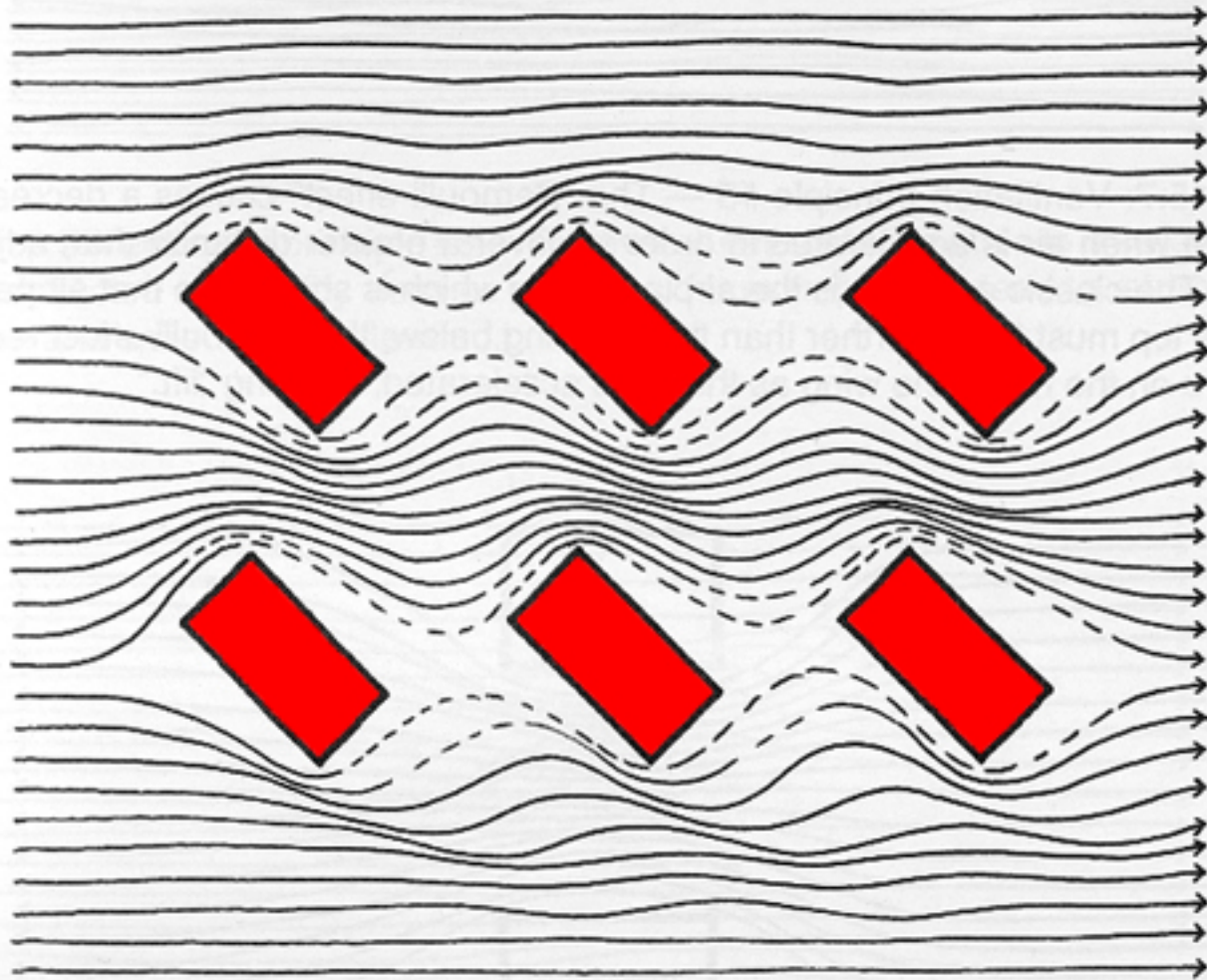
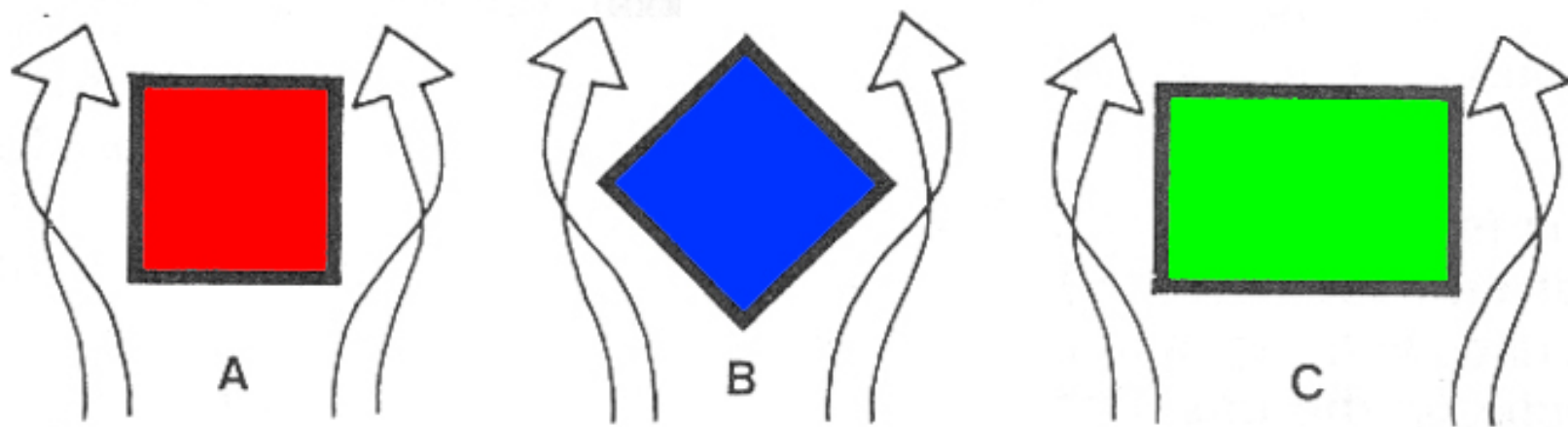
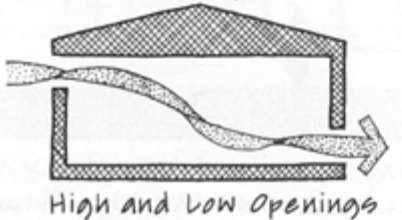
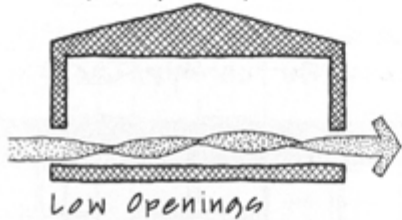
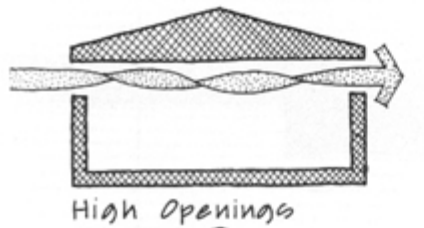
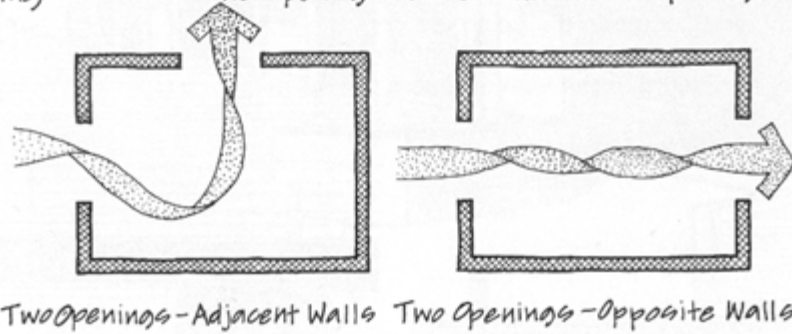
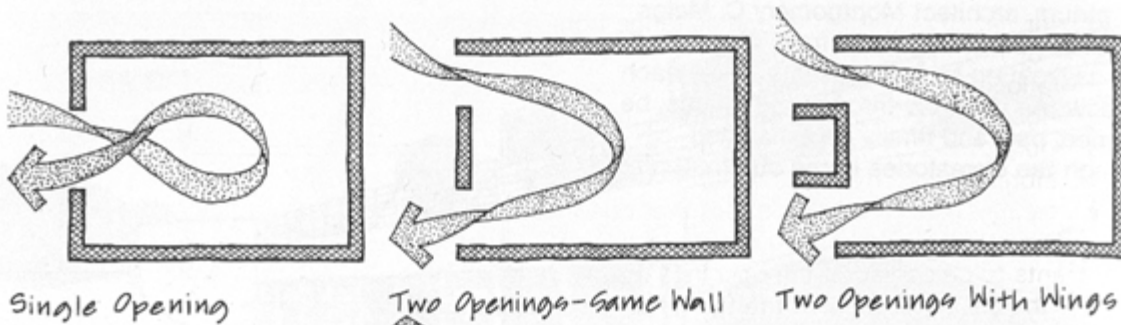

Figure 15.13: Staggered building arrangements result in reduced wind shadows. (After Bowen, 1981.)

FIG. 10d. A compact form—in plan as well as section—is the first rule in minimizing wind exposure. Orientation is equally important: plan B has the same configuration and area as plan A, yet orientation increases its apparent width to the same as C when rotated 45°.





Window height as a fraction of wall height	1/3	1/2	2/3
Window width as a fraction of wall width	1/3	2/3	3/3
single opening	12-14%	13-17%	16-23%
two openings in the same wall	-	22%	23%
two openings in adjacent walls	37-45%	-	-
two openings in opposite walls	35-42%	37-51%	47-65%

Average Interior Air Velocity as a Percent of the Exterior Wind Velocity for Wind Direction Perpendicular to and 45° to the Opening

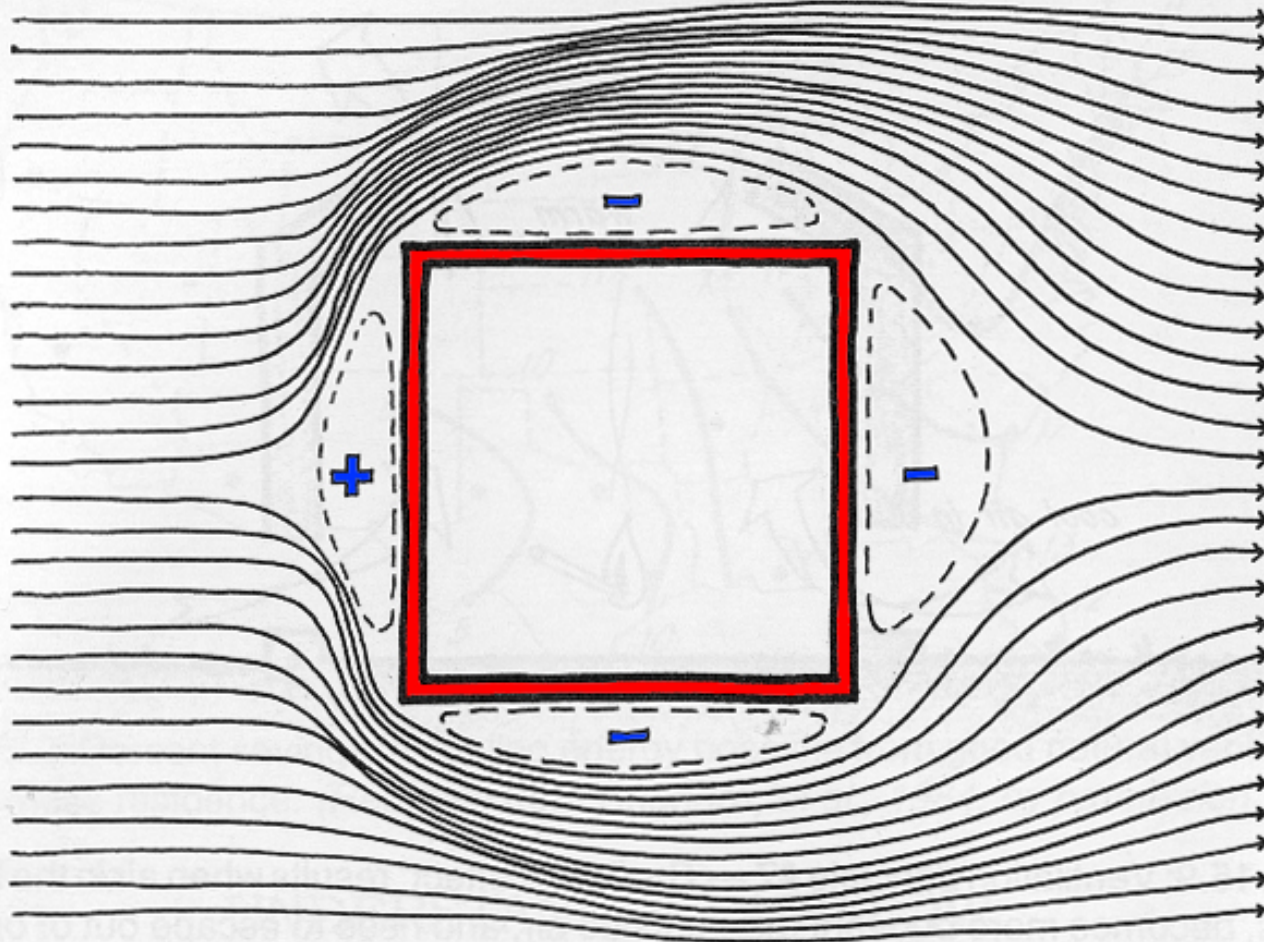

Figure 15.11: Low-pressure zones occur along the sides parallel to the wind and on the leeward side of the building. (After Bowen, 1981.)

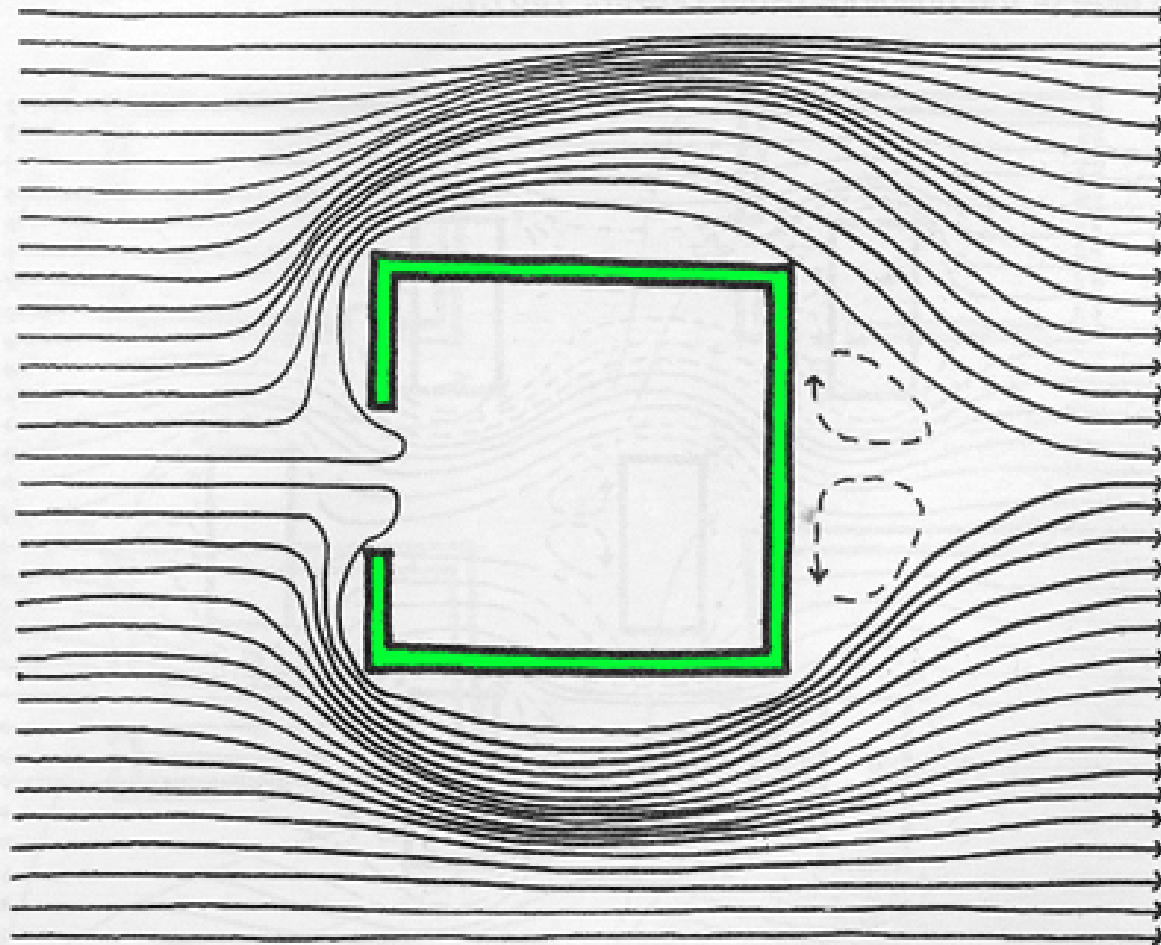

Figure 15.10: Ventilation principle #8 — Cross-ventilation requires an outlet as well as an inlet. (Analogy: water cannot be put into a bottle that is already full unless some old water is removed first — through a hole in the opposite end of the bottle, for example.)

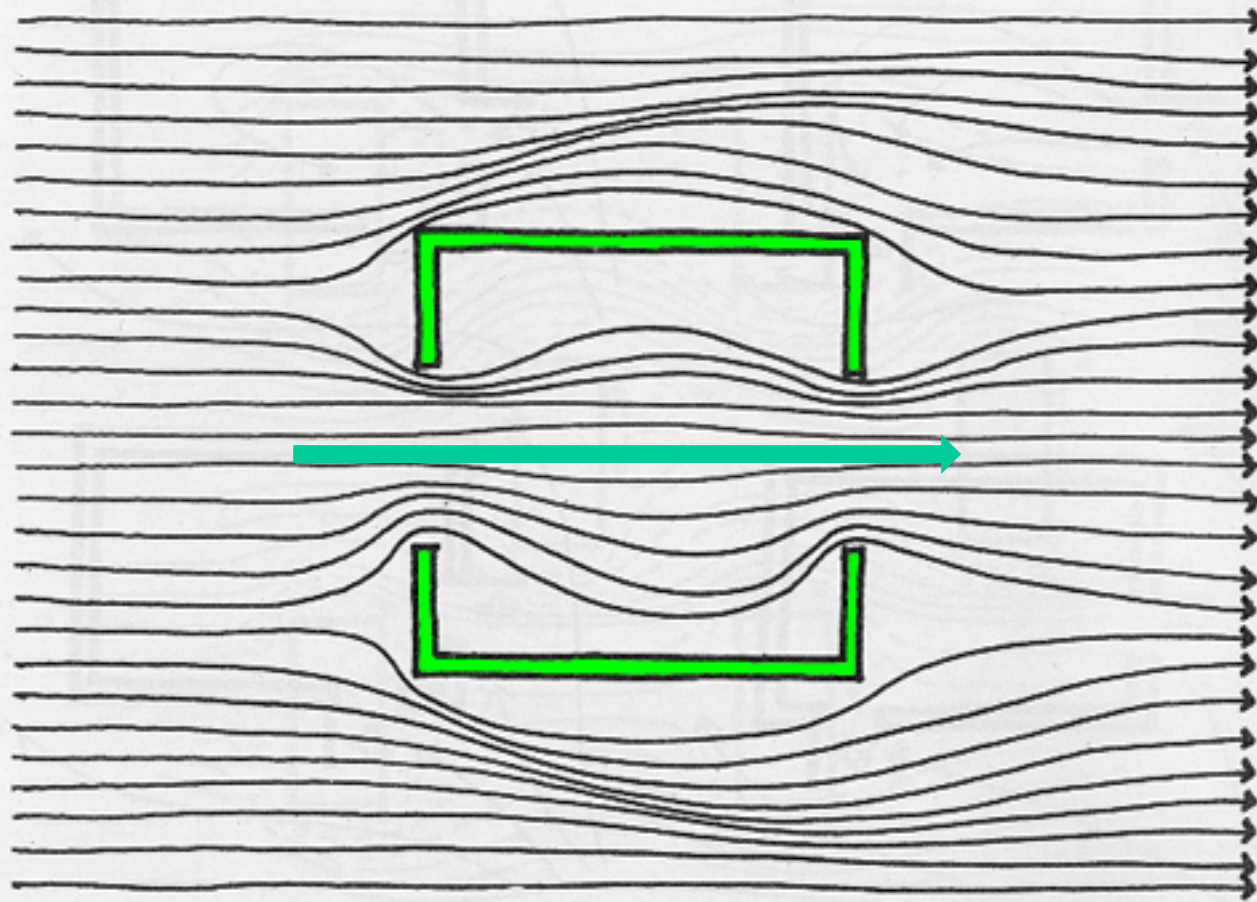

Figure 15.19: Openings of opposite walls relieve high pressure on the windward side, creating good cross-ventilation through the interior. Maximum *air exchange* is created when the inlet and outlet areas are equal, making this the optimum configuration when *building cooling* is the goals. (After Bowen, 1981.)

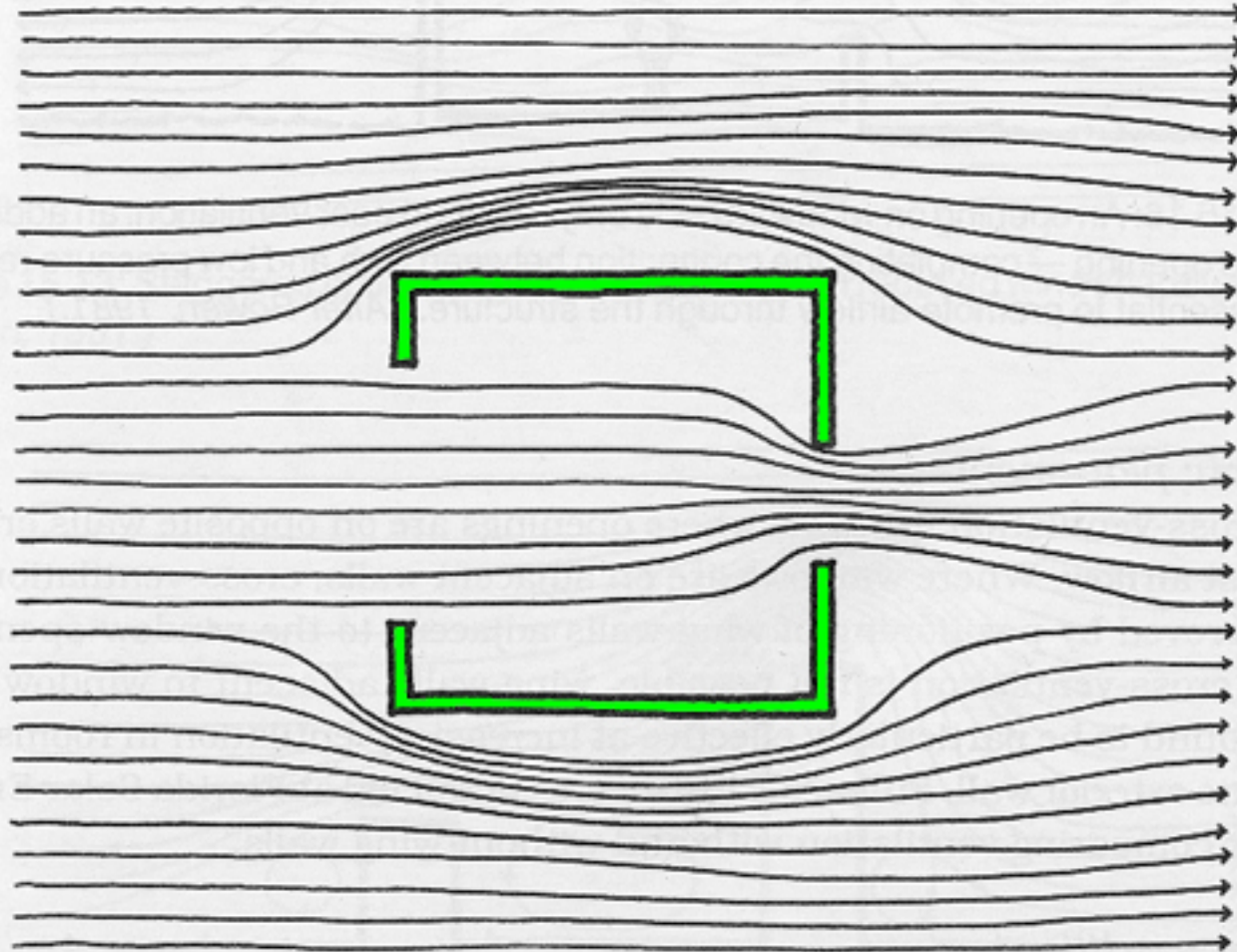

Figure 15.21: If the inlet is larger than the outlet, velocity in the room is reduced (although velocity outside just to leeward of the outlet is increased). This has potential for cooling a localized exterior area such as a patio. (After Bowen, 1981.)

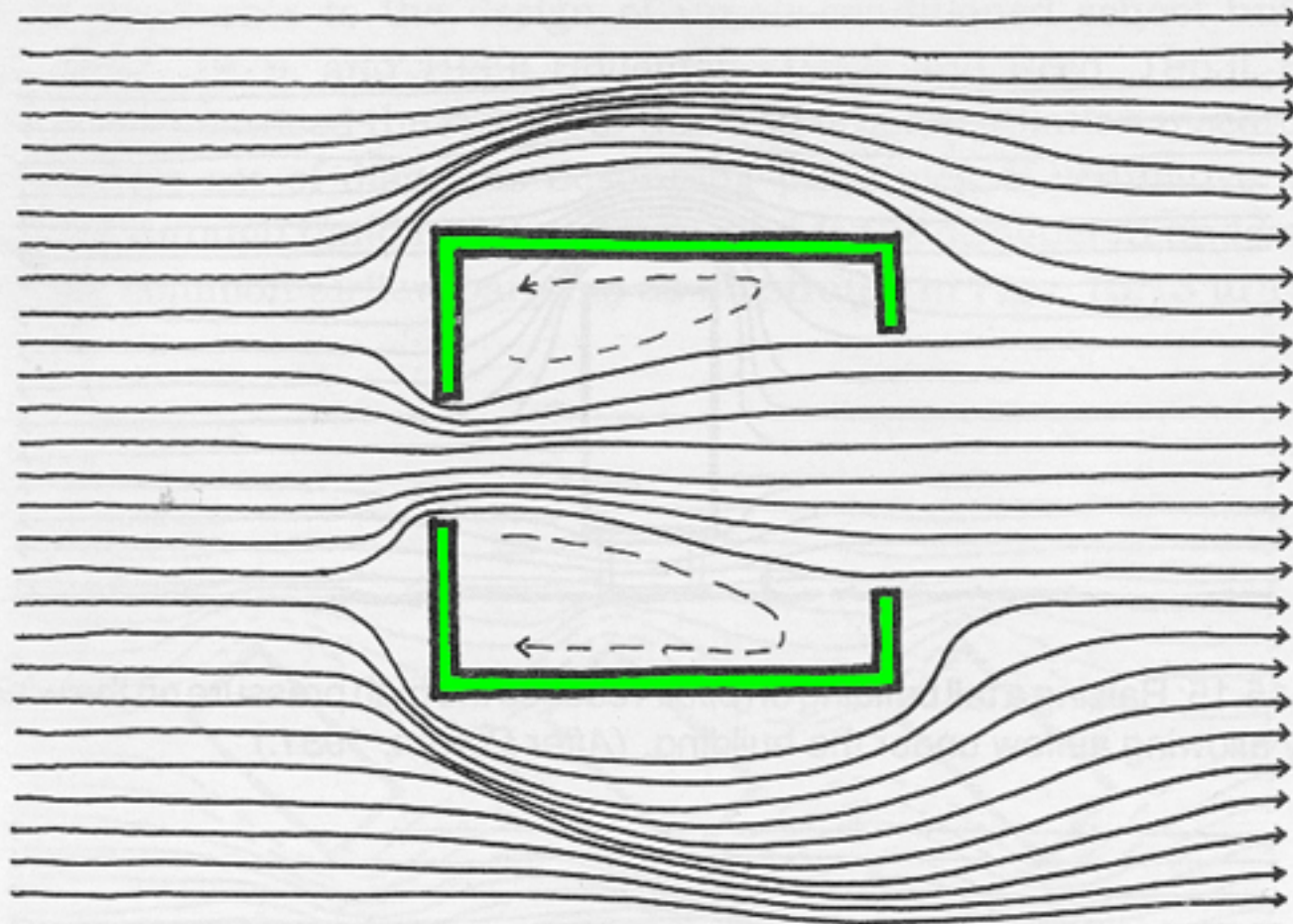
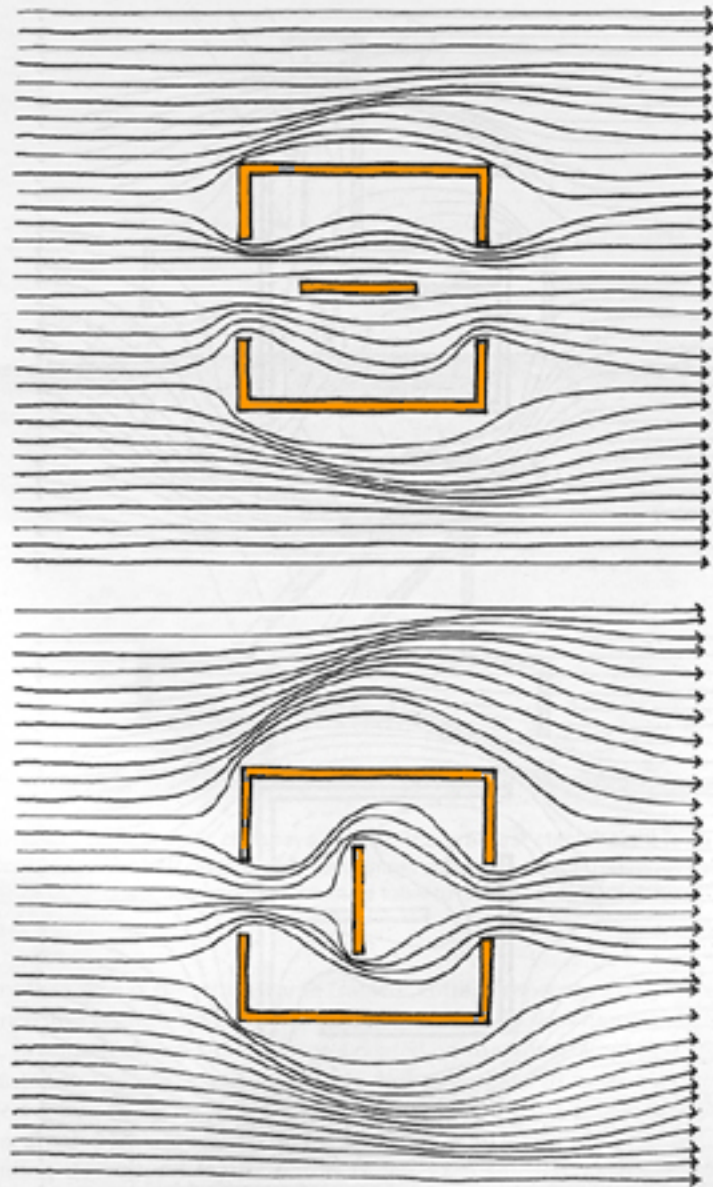
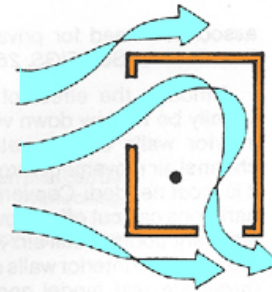

Figure 15.20: Maximum *interior airspeed* is created when the inlet is smaller than the outlet, making this the optimum configuration when *people cooling* is the goal. (After Bowen, 1981.)



HCL

Figure 15.26: An interior partition added parallel to windflow has a minimum effect on velocity and direction, while a similar partition positioned perpendicular redirects the pattern and reduces the velocity. (After Bowen, 1981.)



UNOBSTRUCTED AIR FLOW PATH WILL BE DETERMINED BY LOCATION OF INTAKE VENT IN FACADE. NOTE STATIC AREA "●".

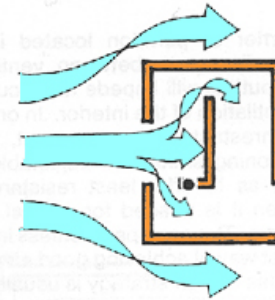

DIRECT INCOMING AIR FLOW IS IMMEDIATELY BLOCKED BY PARTITION. LIT. FLOW AROUND OBSTRUCTION RESULTS IN MEANDER COOLING EFFECT.

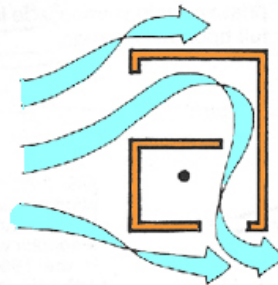

PLACING PARTITION IN STATIC AREA WILL HAVE LITTLE EFFECT ON AIR FLOW PATTERN

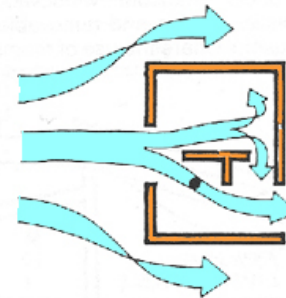

PARTITION PLACED TO "SPLIT" INCOMING FLOW DECIPATES LITTLE ENERGY. RESULT: OVERALL ADEQUATE VENTILATION

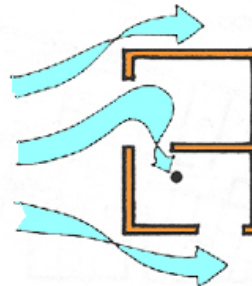

PARTITION PLACED IN FLOW ZONE ABSORBS DYNAMIC FORCE. NEITHER ROOM RECEIVES ADEQUATE VENTILATION

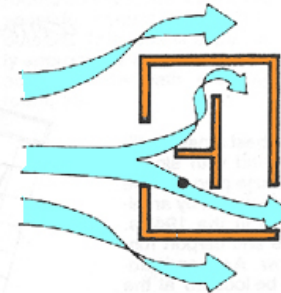

DIVIDER PARTITION SPLITS AIR FLOW; LOWER ROOM IS WELL VENTILATED, BACK ROOM RECEIVES LITTLE AIR MOVEMENT

- Fin walls can significantly increase ventilation through windows on the same wall.
- Poor ventilation results from fin walls placed on the same side of each window or when two fins are used on each window.

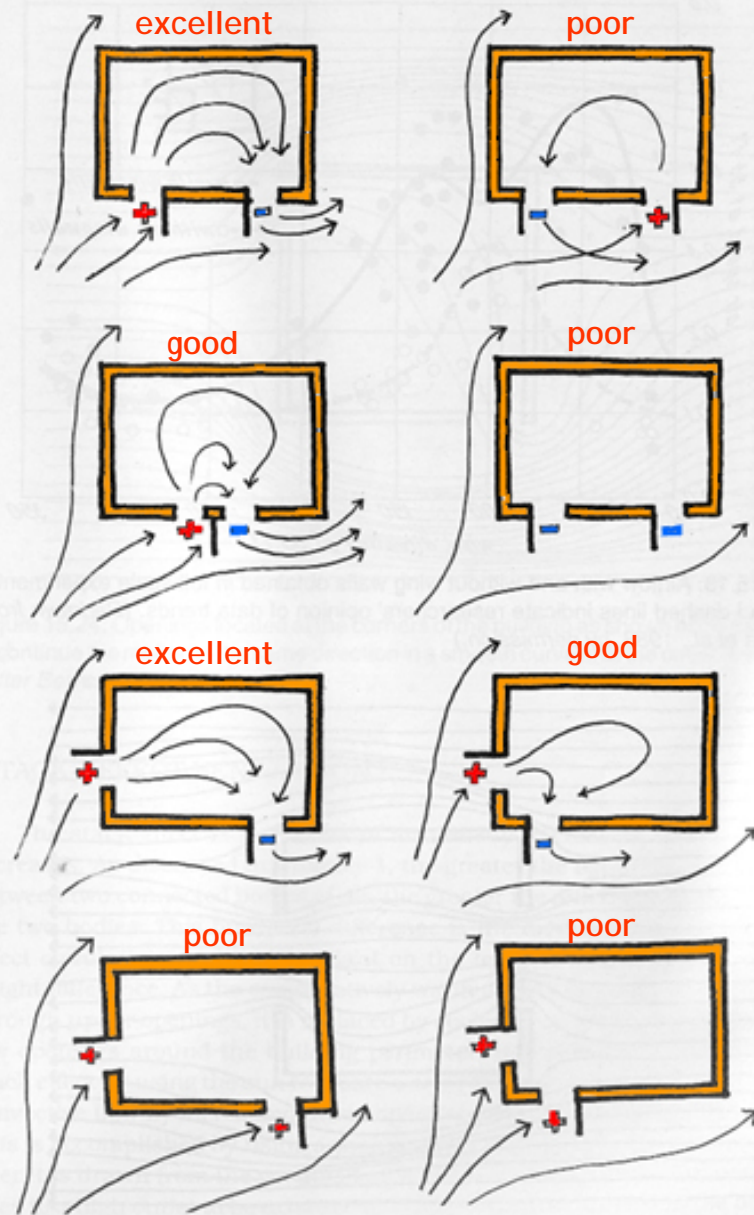

Figure 15.17: Wing wall design patterns for two windows on the same or adjacent walls showing probable airflow patterns and wind directions for improved ventilation performance due to wing walls: (a) excellent, (b) poor, (c) good, (d) poor, (e) excellent, (f) good, (g) poor, and (h) poor. (After Chandra et al., 1983.)

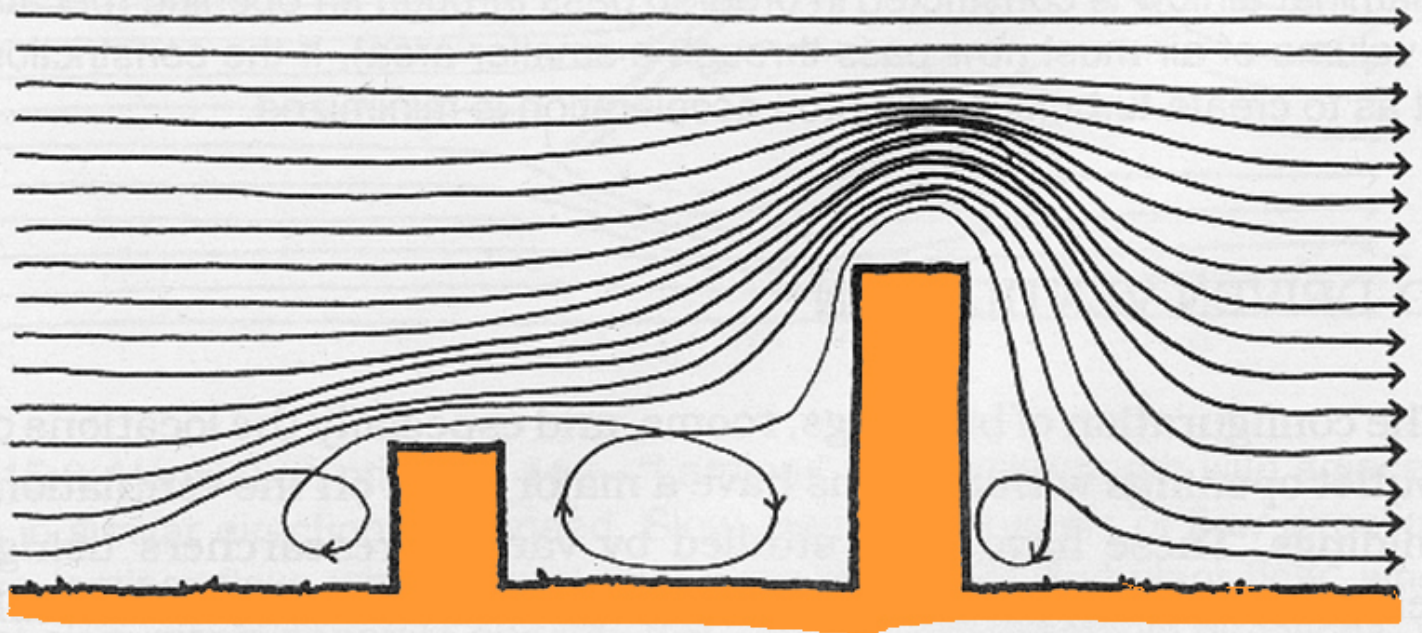

Figure 15.14: A low building placed in the windward path of a tall building produces a large amount of turbulence between the two. (After Bowen, 1981.)

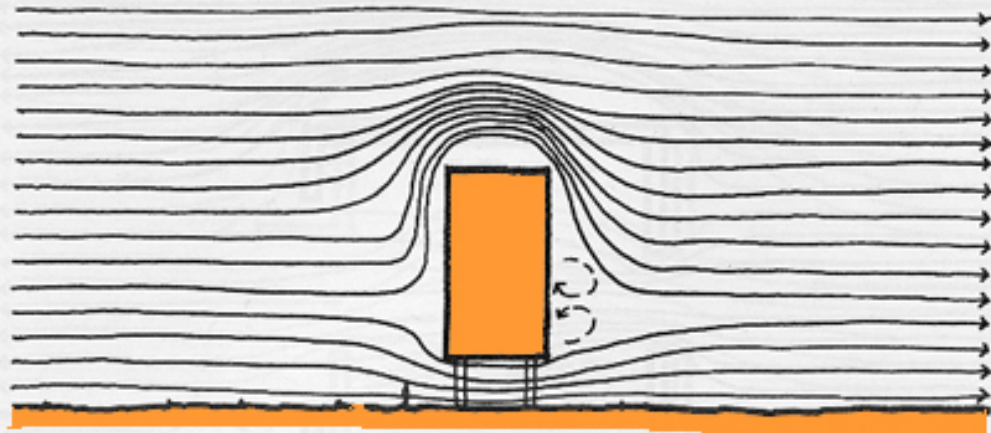

Figure 15.15: Raising a tall building on *piloti* reduces the high pressure on the windward side by allowing airflow under the building. (After Bowen, 1981.)

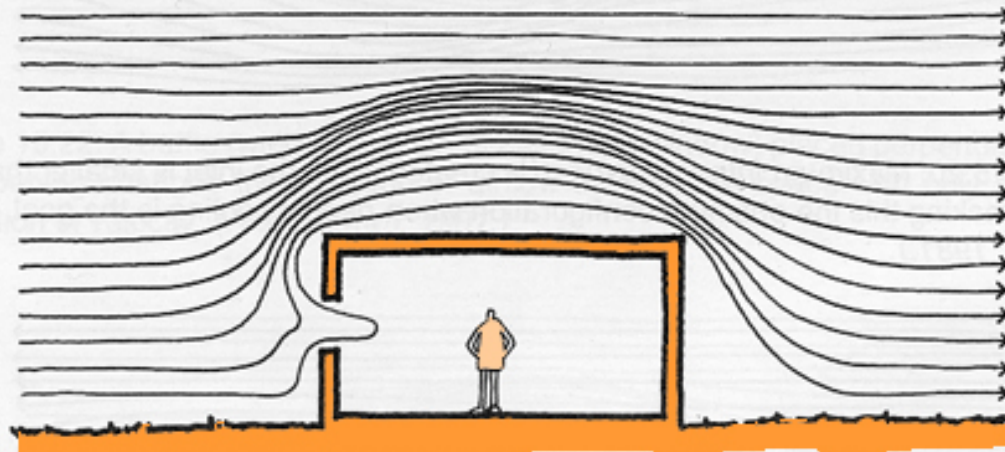

Figure 15.16: An opening on windward side only results in poor ventilation; an additional leeward opening — completing the connection between high and low pressure regions — is essential to promote airflow through the structure. (After Bowen, 1981.)

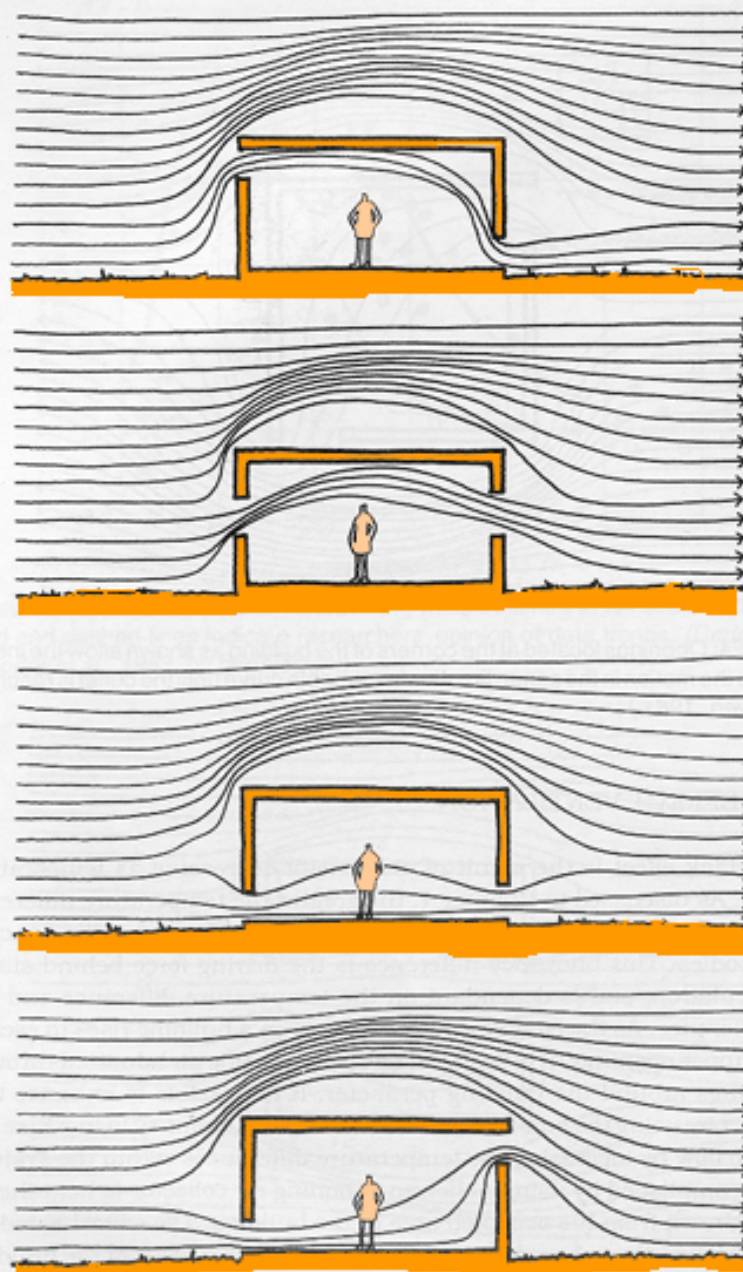

Figure 15.25: The vertical position of the *inlet* window is important in maximizing the airflow through the lower, occupied portion of the room; the low inlet is best for cooling. The *outlet* location has little effect on flow within the room. (After Bowen, 1981.)

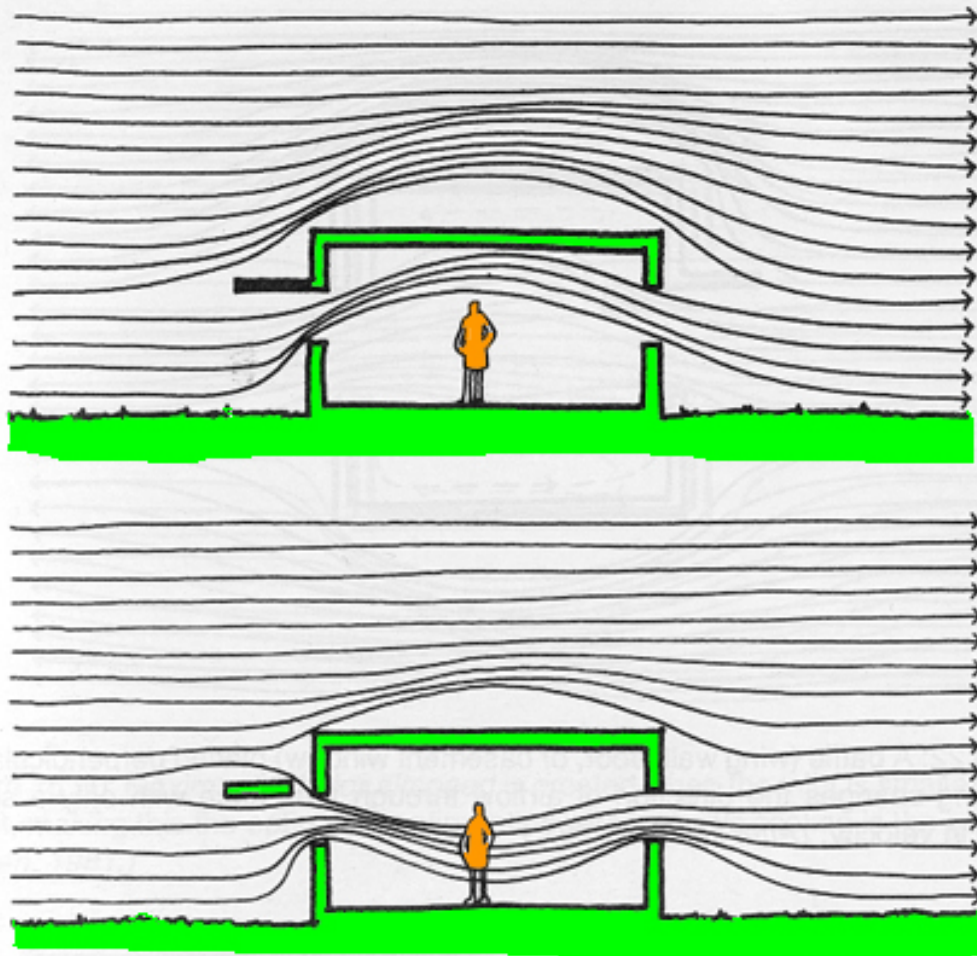
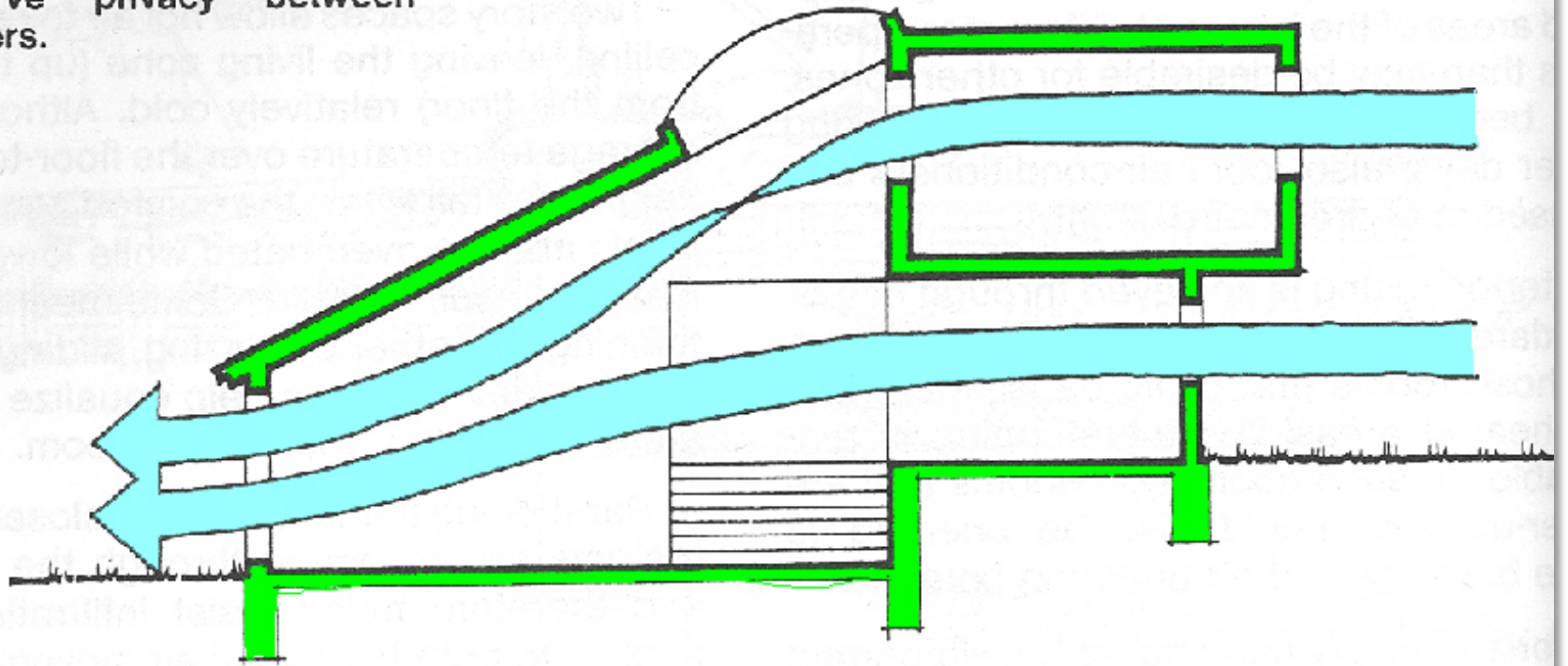

Figure 15.26: An overhang above the inlet window directs the interior airflow along the ceiling out of the occupied zone; the addition of a slot separating the overhang from the building redirects the flow down into the room, increasing the useful cooling effect. (After Bowen, 1981.)

FIG. 26c. The open plan can be executed in an overlooking mezzanine arrangement to preserve privacy between quarters.



UMBRELLA ROOF KEEPS
RAIN OFF SIDE WALLS,
ALLOWS FULLEST USE OF
WALL VENT'N OPENINGS

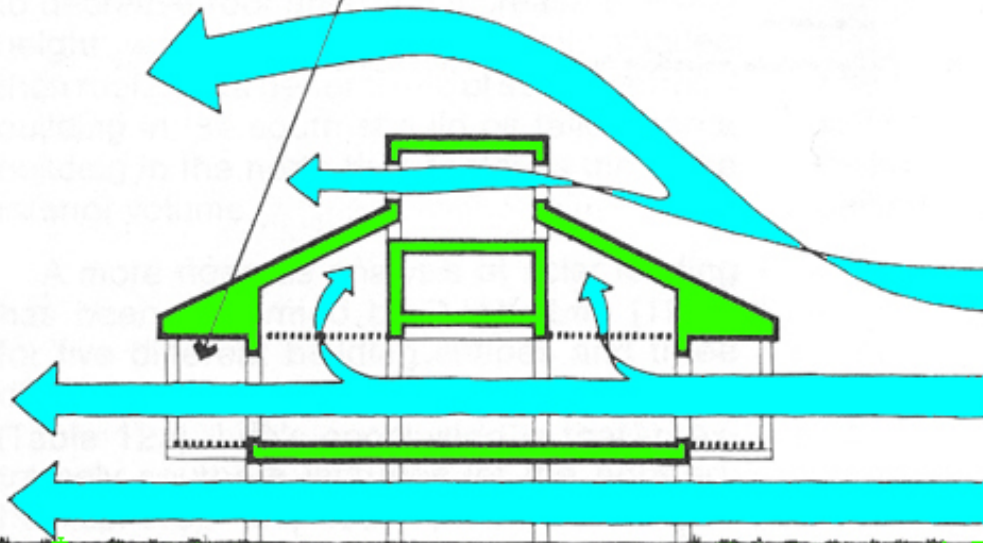

FIG. 13c. "Piano nobile"—the elevated living floor—is a design practice commonly found in the tropics and coastal states where high humidity levels demand the most of ventilation. Air currents are stronger higher above the surface, and elevated design keeps the underside of the house dry.

FIG. 13d. "single pile"—one room deep—houses are common vernacular throughout mid-Atlantic states. Stacking rooms high instead of deep offers best cross ventilation opportunities. The two story, one room deep style is known as an "I" house.

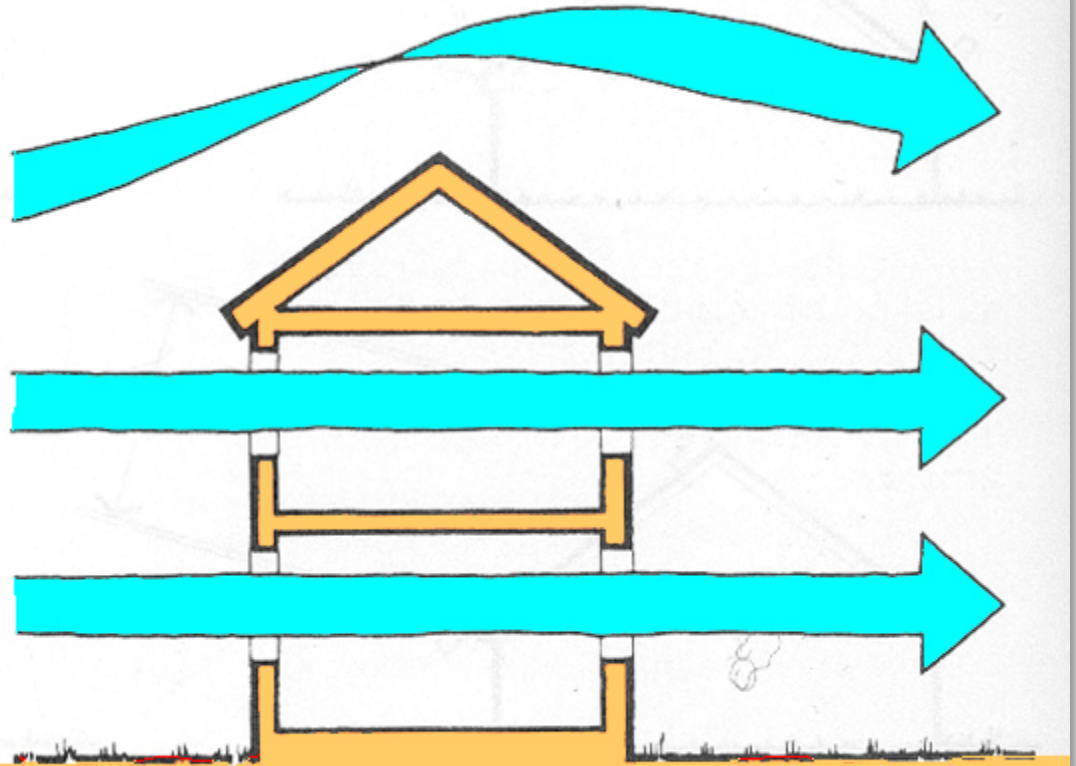
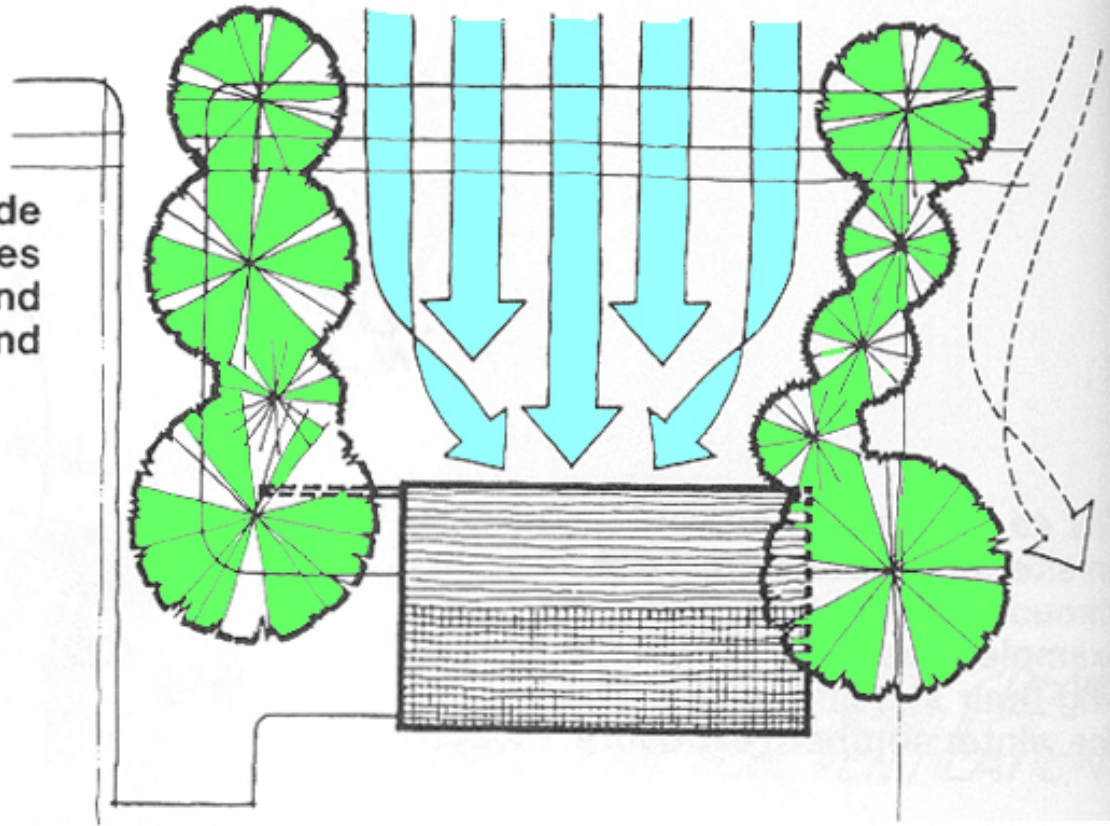
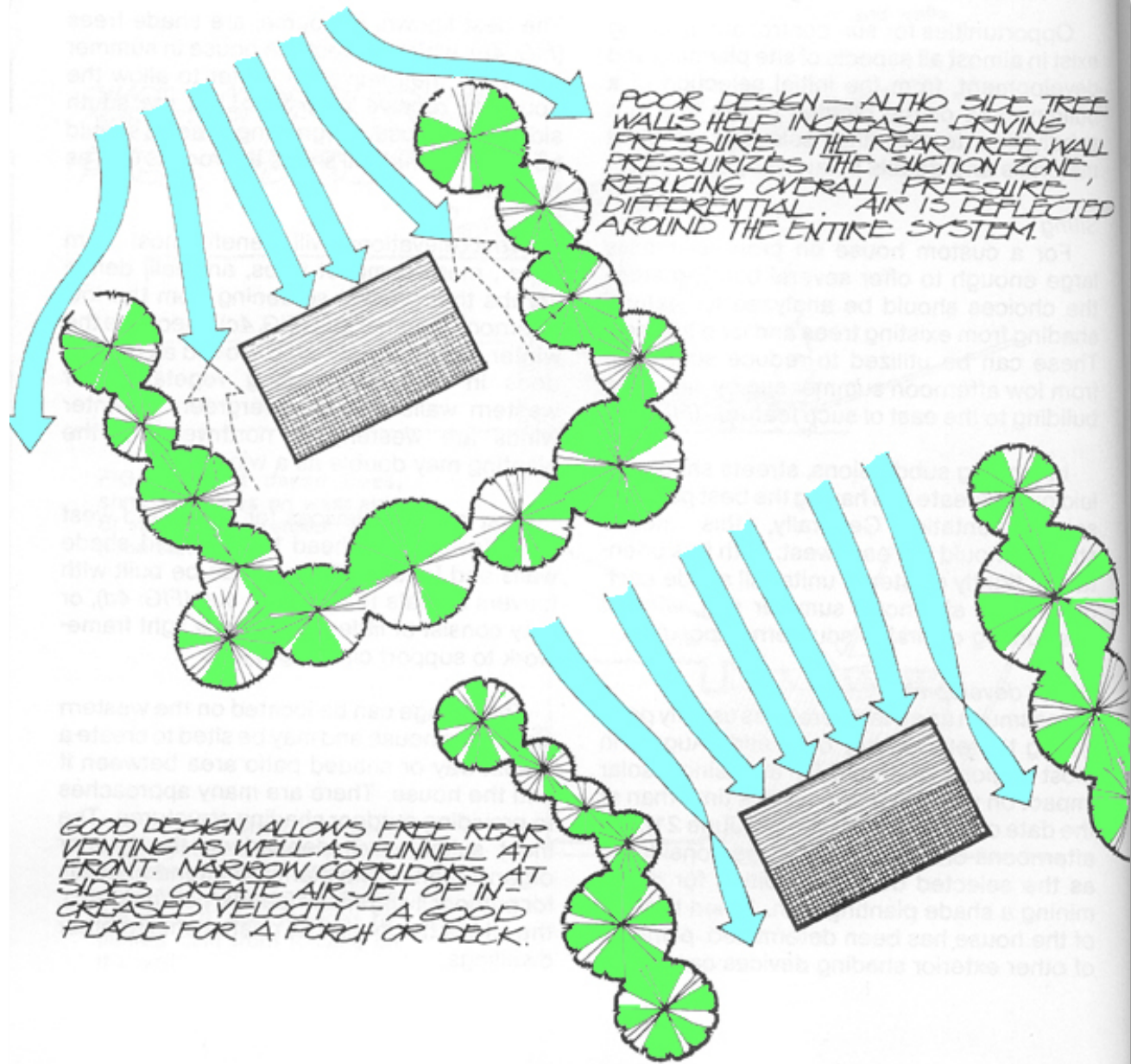

FIG. 5b. Wind Funnels

Tree planting can be used to guide wind into unit. Here tree funnel lines are "disguised" as driveway and property line planting to better blend with siting.





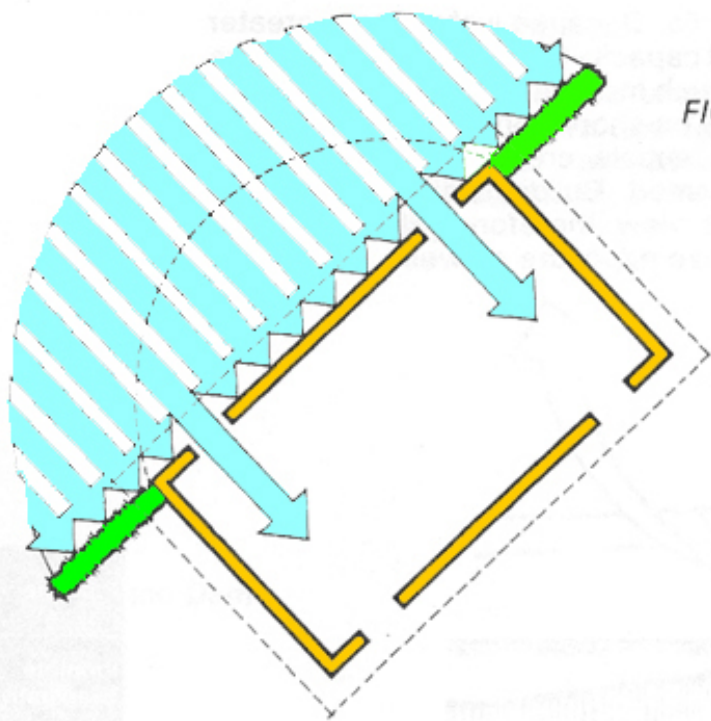

FIG. 5c. Wind Dams, continued

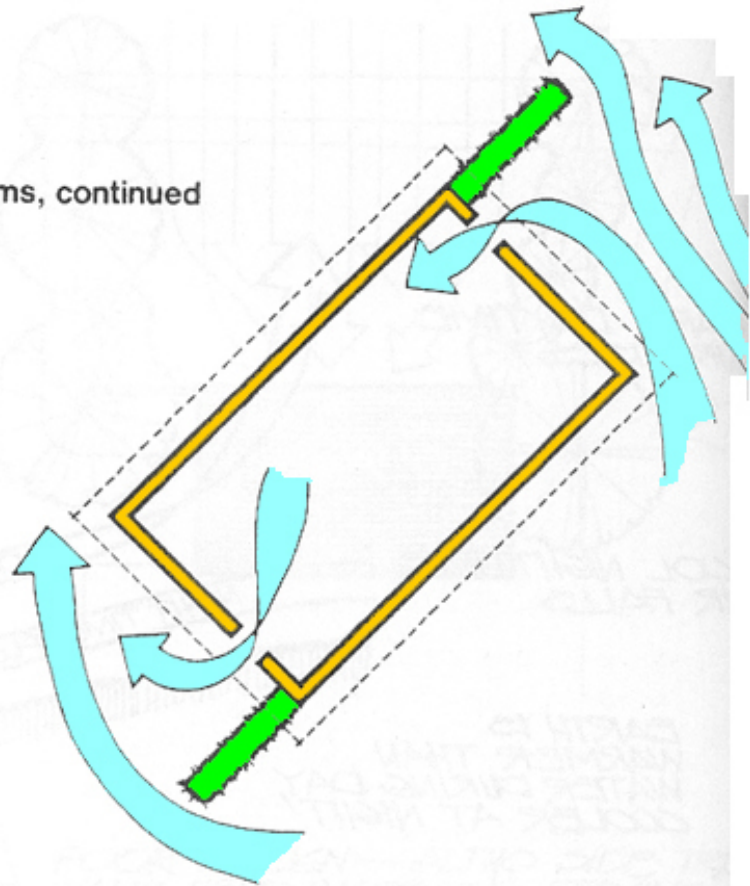

FIG. 47d. The type of window can have considerable effect on the path of internal air flow and its cooling value. There is little mystery in the effect produced by these windows—they are just as expected.

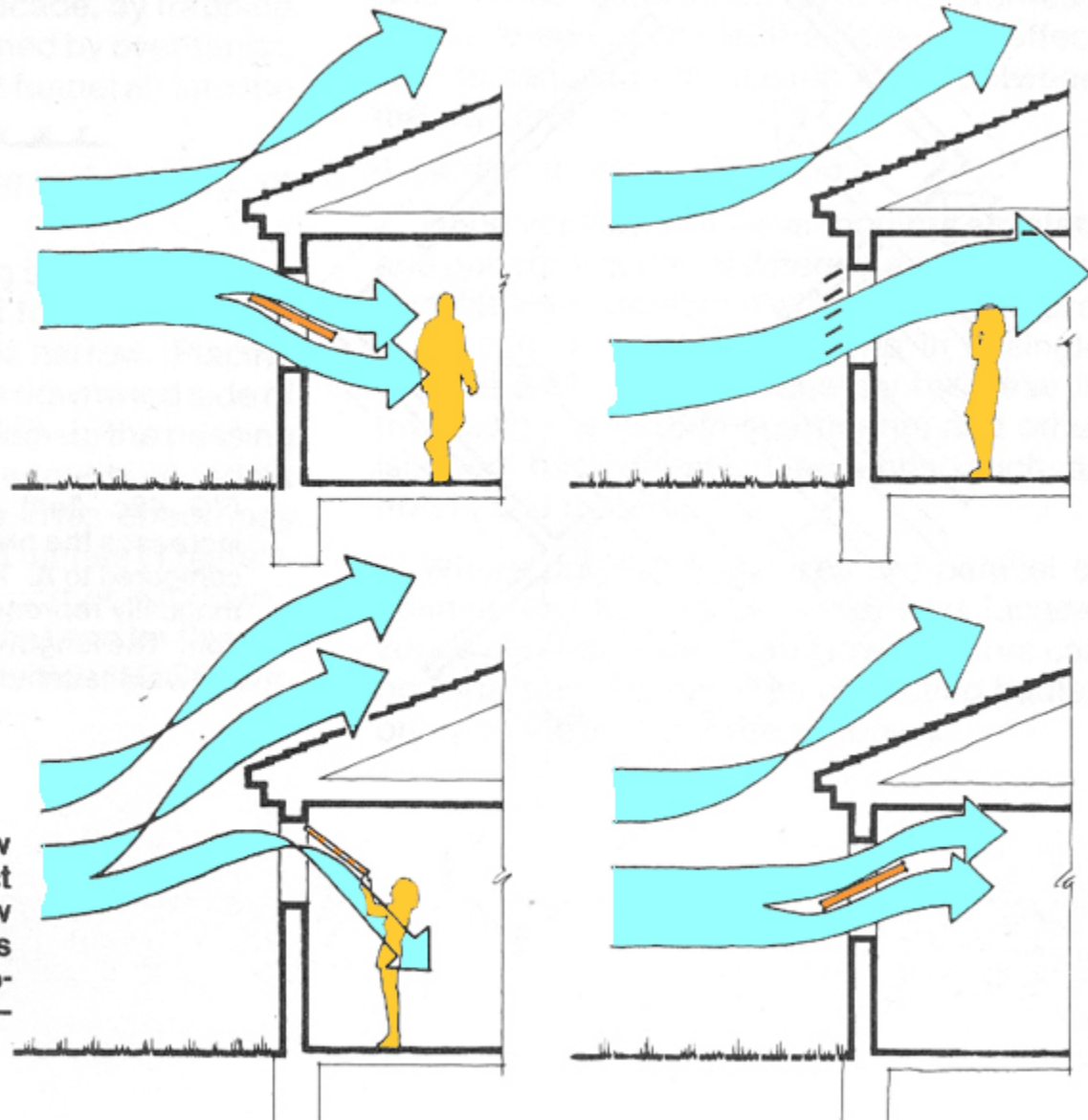
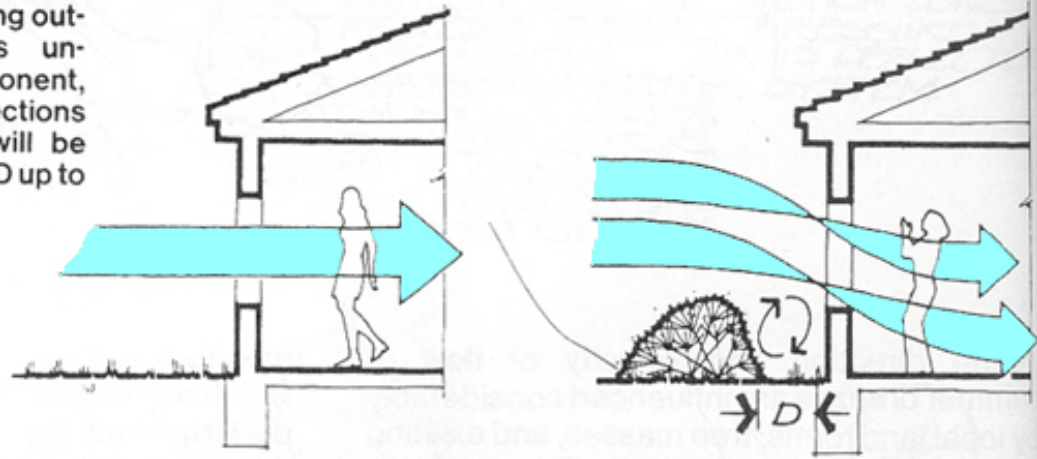
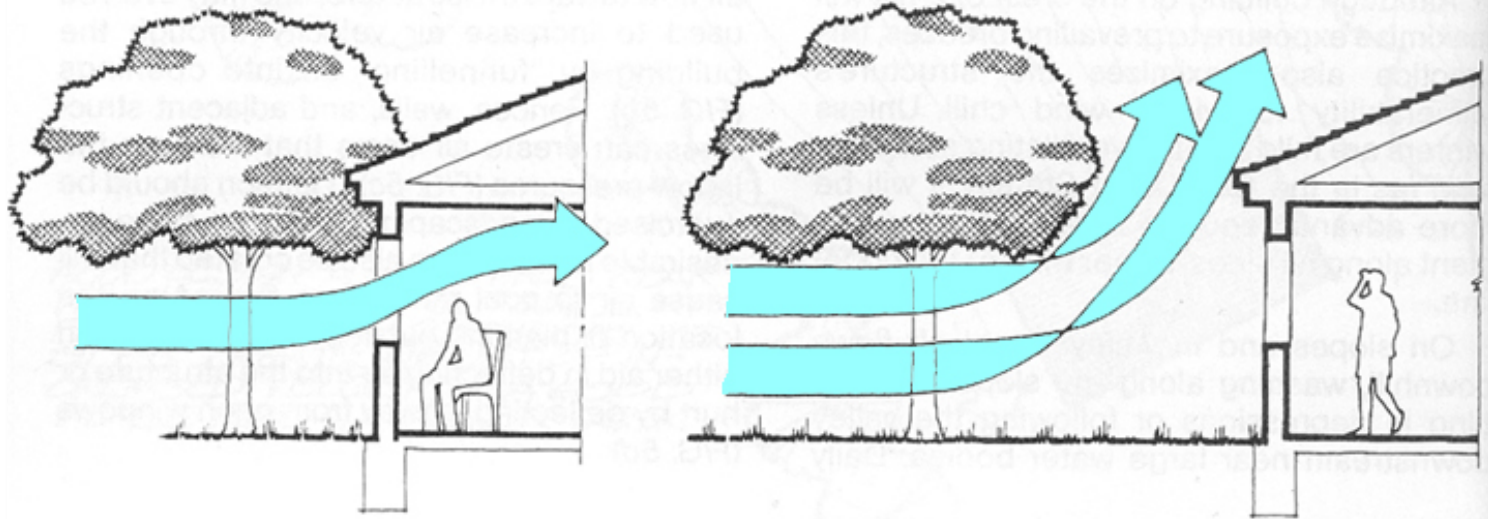

FIG. 5d. Wind Deflectors

Hedge and shrub planting outside window relieves unwanted pressure component, fosters downward deflections of air stream. Effect will be produced for distances D up to 15 to 20 ft.



Influence of tree canopy outside the window is to "lift" or warp the airstream upward by relieving downward pressure (opposite of shade-effect). If tree is immediately outside window it will produce a ceiling wash flow. At a distance from the house, canopy may warp the airstream sufficiently to miss the house altogether.





Green on the Grand, Kitchener:

For operable windows to be able to work, you have to have enough of them as well as provide for through ventilation.



IMPORTANT!

For natural ventilation to work you need:

OPERABLE WINDOWS - the more the better in our climate

FLOW THROUGH ABILITY - air must be able to *move*

Stack Effect (ie. warm air rises):

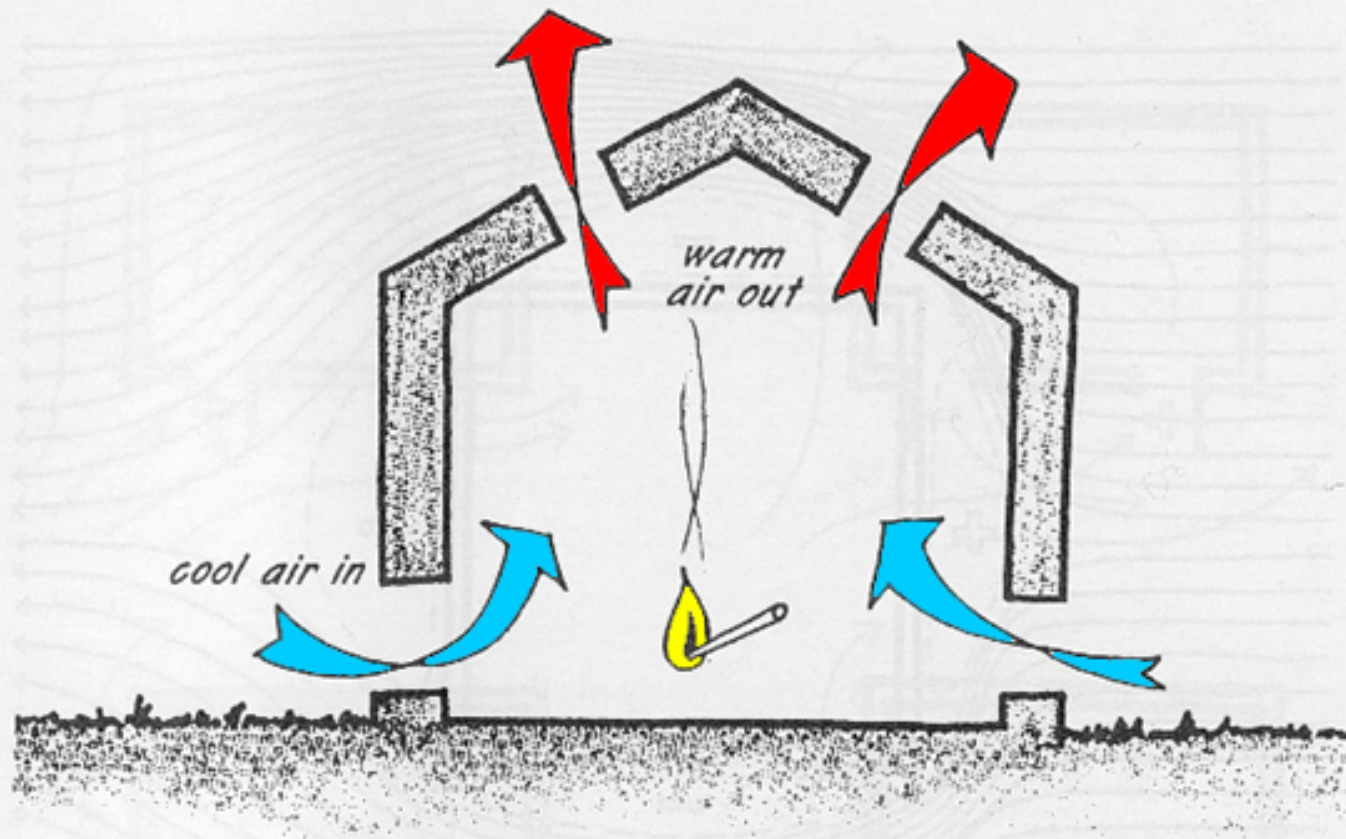

Figure 15.9: Ventilation principle #7 — The “stack effect” results when air in the building warms, becomes more buoyant than outside air, and rises to escape out of openings high in the building.

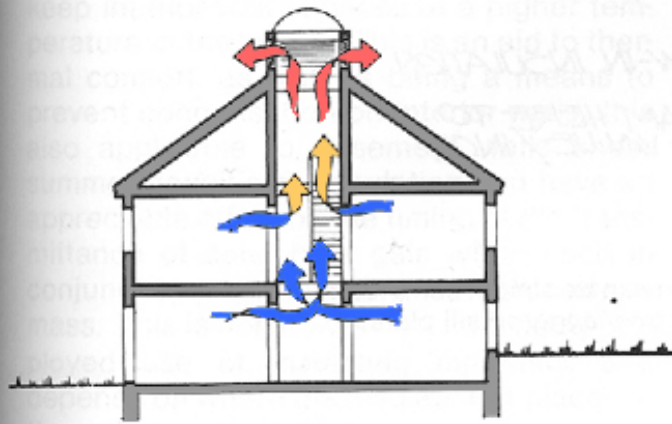

FIG. 27a. Central stair to vent capped with skylight & monitor makes an excellent "central ventilating" system as well as a potential sales appeal item.

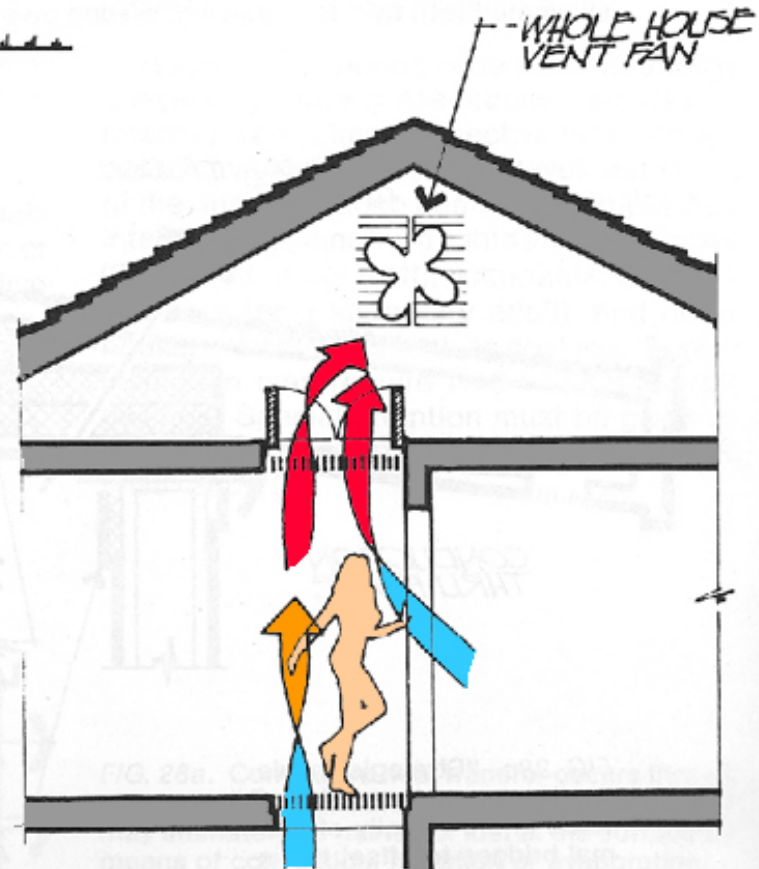
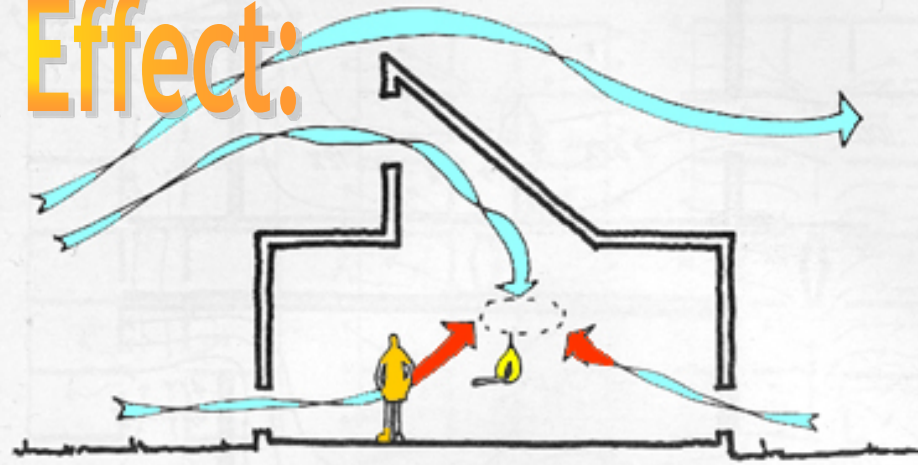

FIG. 27b. (Right) Stack action can be coaxied through conventional house without unorthodox architectural style if adequate passage is provided. Floor grates, louvered ceilings, gable ends or ridge vents can provide the route.

Assisted Stack Effect:



Add heat!



Figure 15.27: A high window acting as a windscoop inlet together with a low outlet must overcome the stack-effect tendency of the warm inside air to rise; reorienting the windscoop to leeward reinforces the stack effect and increases airflow.



YMCA Environmental Learning Centre









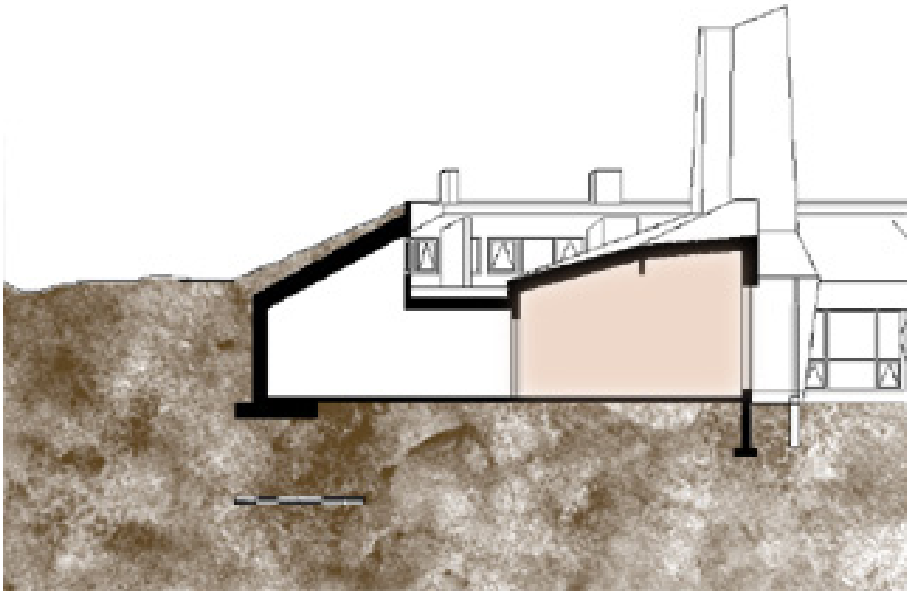
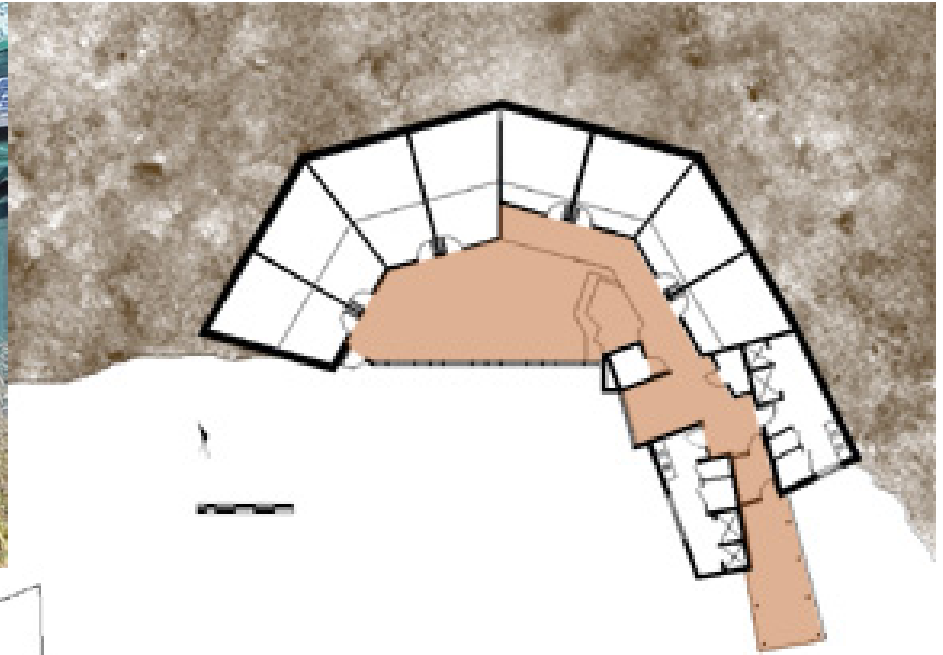

YMCA Burrows:

What is Evaporative Cooling??

The exchange of **sensible heat** in the air for the **latent heat** of water droplets of wetted surfaces. It may be used to:

- Cool the building (where wetted surfaces are cooled by evaporation),
- Cool building air (directly by evaporation or indirectly by contact with a surface previously cooled by evaporation),
- Or cool the occupants (where evaporation of perspiration cools the skin surface.)

Sensible heat is the dry heat in the air.

Latent heat is the wet heat released into the air as water changes from liquid to vapour by evaporation or boiling.

Direct Evaporative Cooling

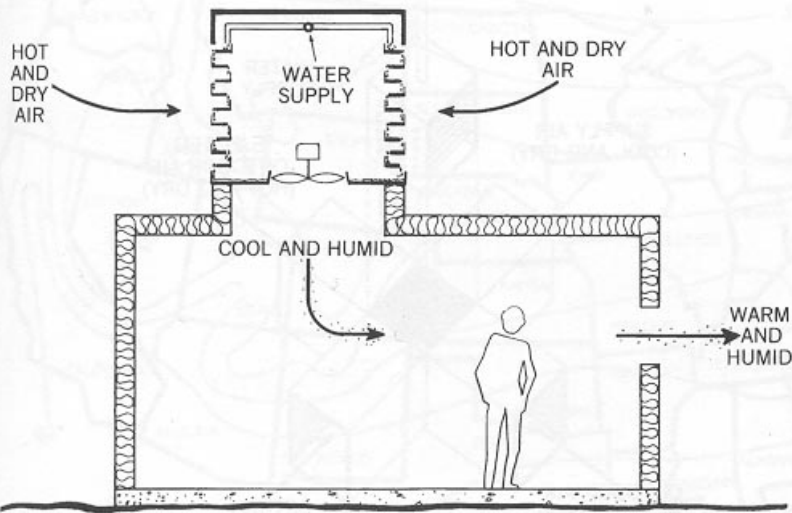
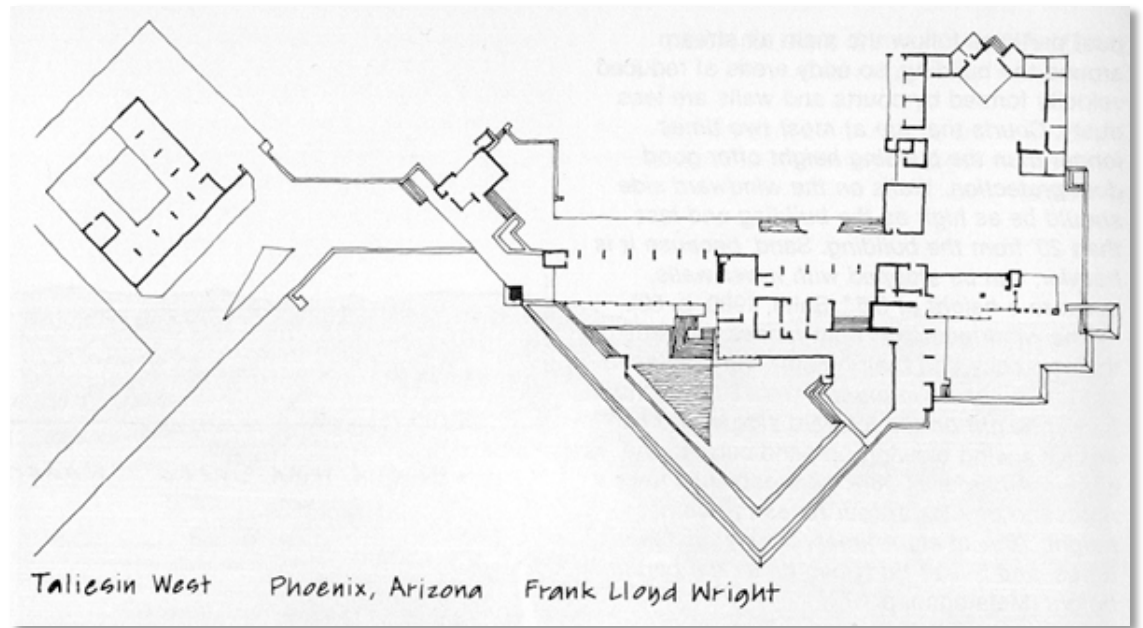

Figure 10.11a Evaporative coolers (swamp coolers) look a great deal like central Air Conditioning units, but their cooling mechanism is very simple and inexpensive. They are appropriate only in dry climates.

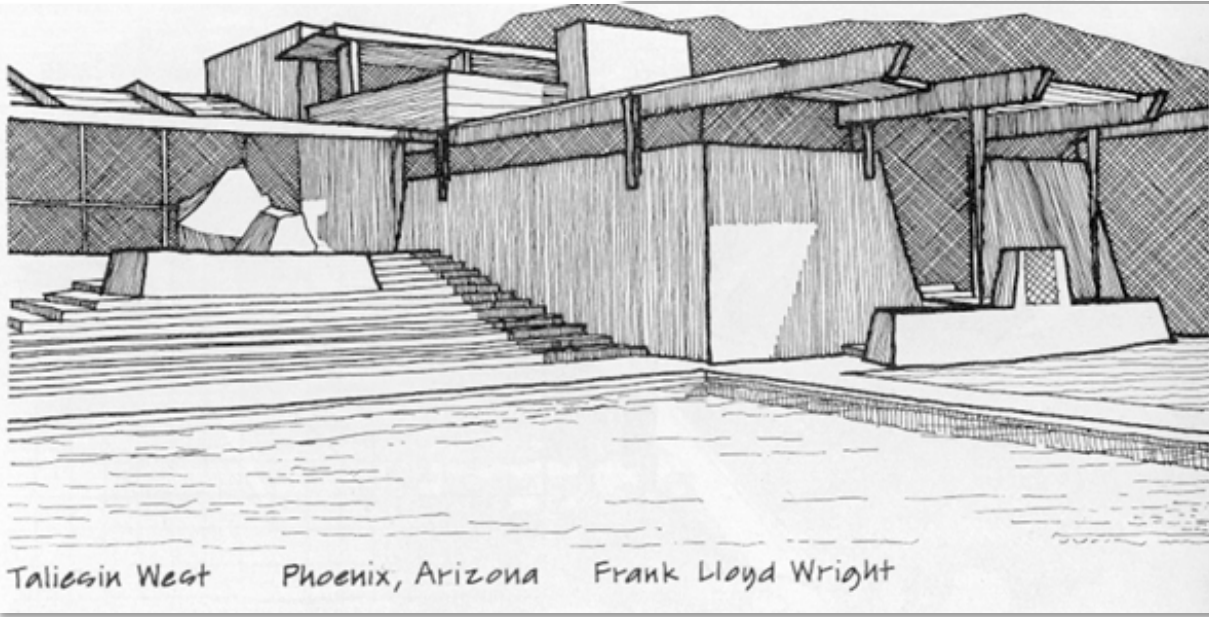

Figure 10.11b Evaporative coolers are widely used in hot and dry regions. This is an example of a direct evaporative cooler on the roof of a house.

Direct Evaporative Cooling



Taliesin West Phoenix, Arizona Frank Lloyd Wright



Taliesin West Phoenix, Arizona Frank Lloyd Wright

Wind passing over the water can pick up humidity in dry climates and carry it into the building.





COURTYARDS

Aesthetic, Social, and Thermal Delight



JOHN S. REYNOLDS

ArchitectureWeek.com

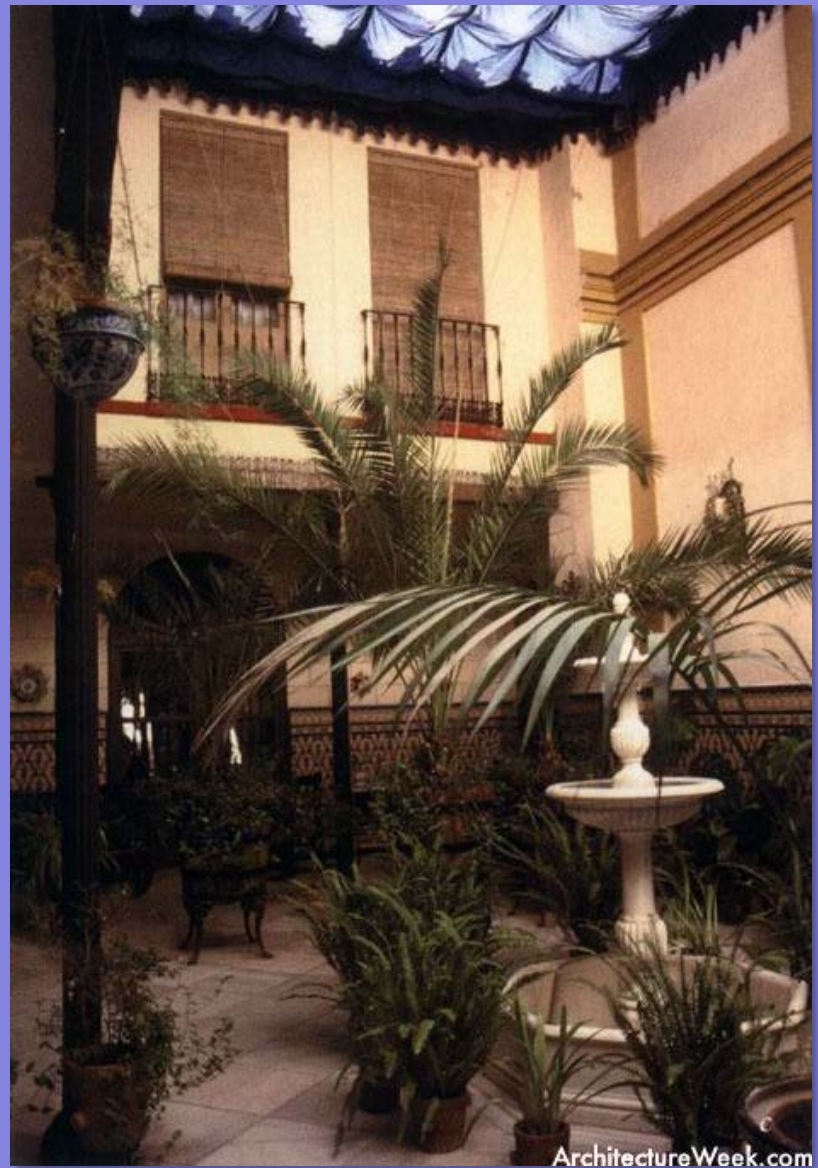

ArchitectureWeek.com





Massey College, Toronto



Perimeter Institute, Waterloo

Eco Houses: Wind Towers

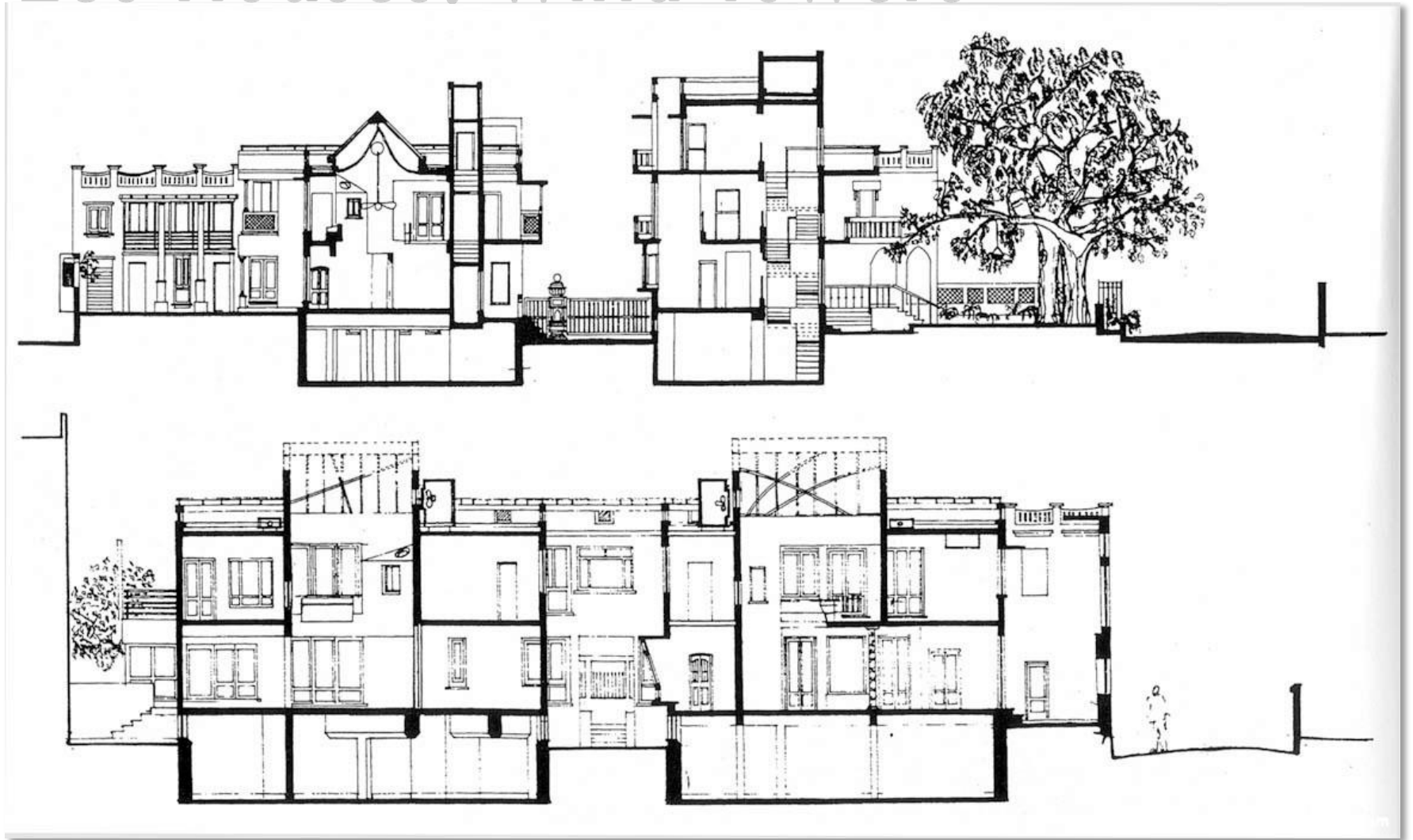

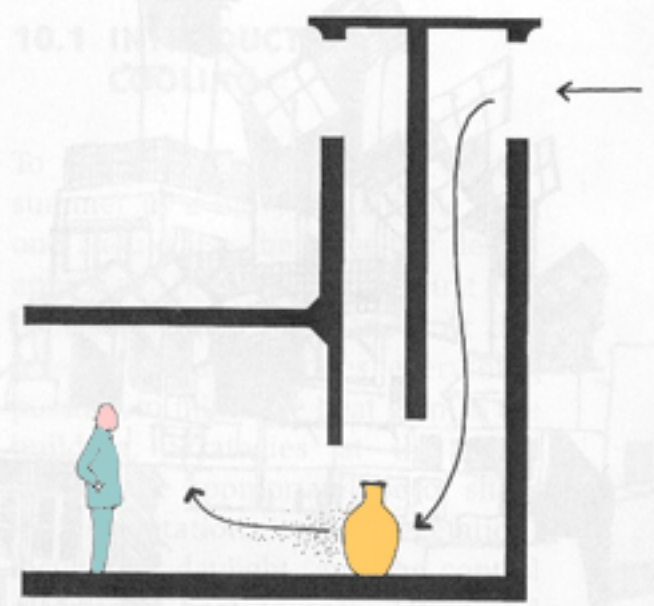
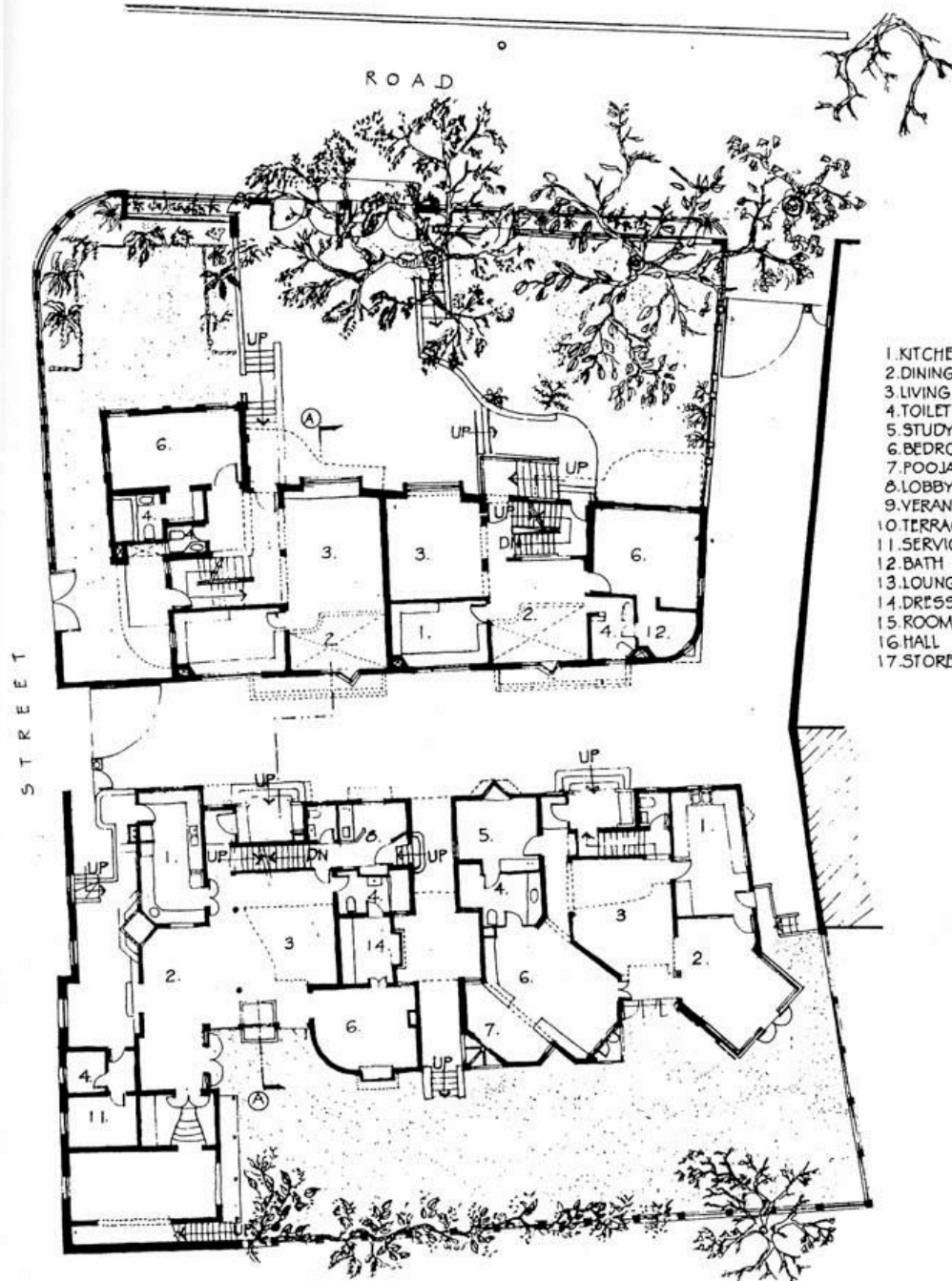
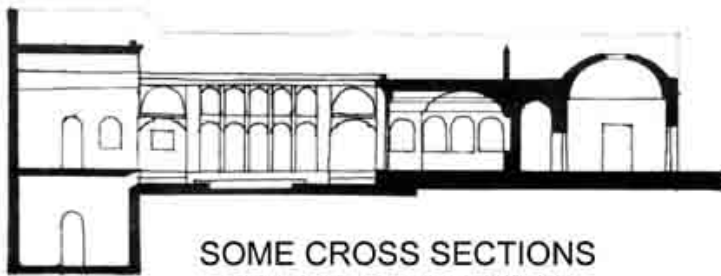
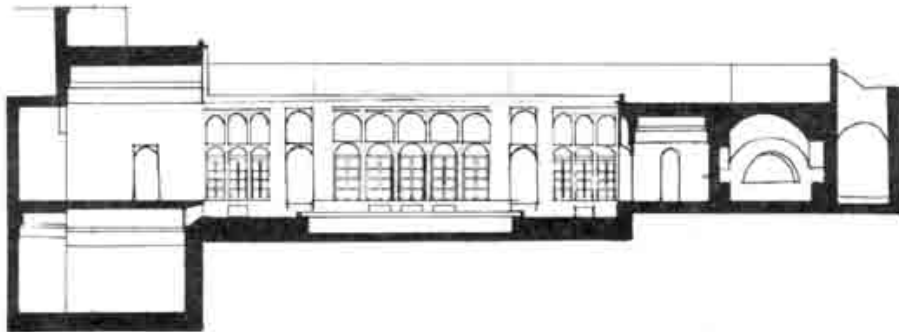
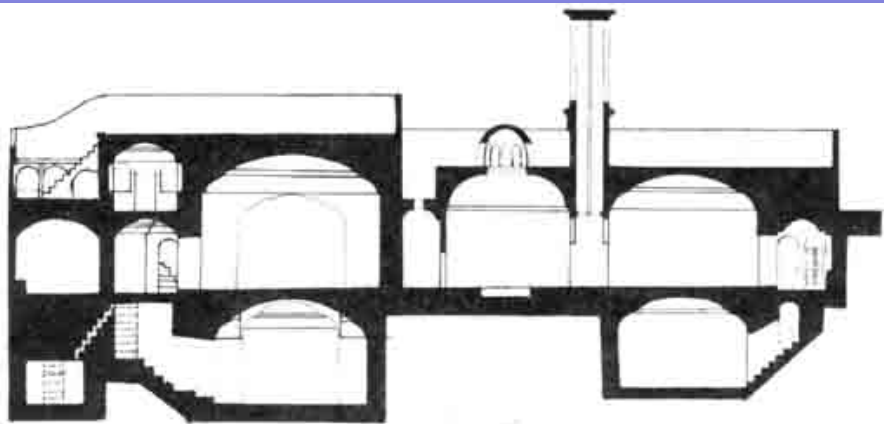

Figure 10.2e Some wind towers in hot and dry areas cool the incoming air by evaporation.



SOME CROSS SECTIONS
TYPICAL HOUSE YAZD





ArchitectureWeek.com

WIND DRIVEN EVAPORATIVE COOLING

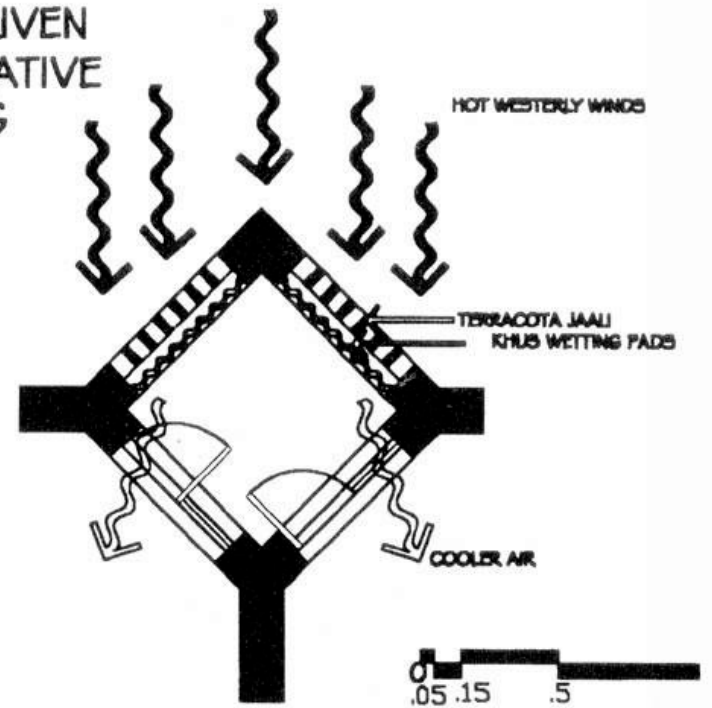



BedZED





One bedroom flat with
4 bed maisonette over.

Pedestrian access
to workspaces.

Organic café / shop

3 bed maisonette with
one bed flat over.

Vehicular mews -
access to workspaces
and dwellings

Workspaces with timber
mezzanine and integral
shower room

3 bed maisonette with
one bed flat over.

Southern aspect
maisonettes have
ground floor gardens
and access road.

Solar Chimneys:

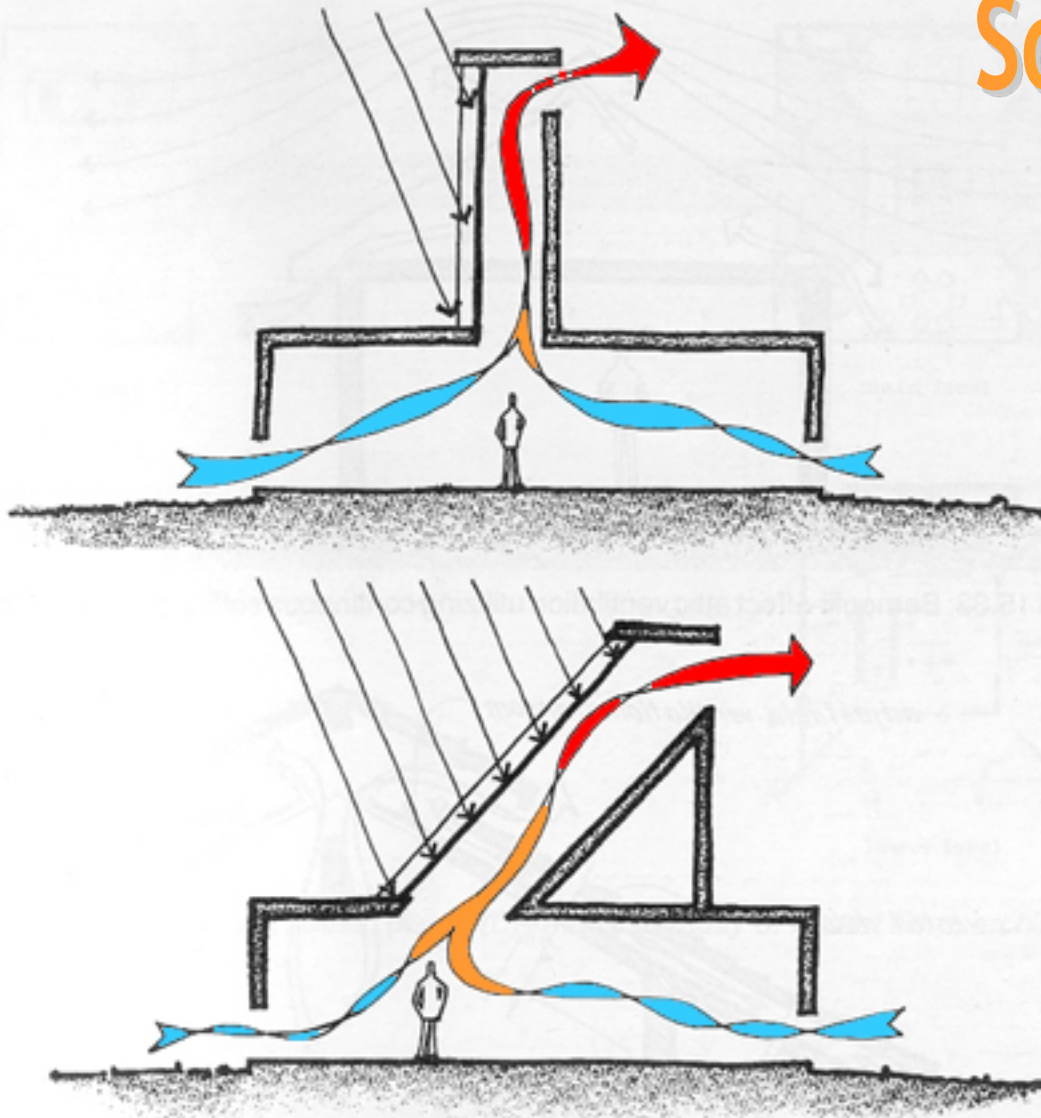

Figure 15.32: Vertical solar chimneys provide the greatest stack height for a given collector size but this tilt is not effective for summer collection. Sloped chimneys provide a better summer collection angle but must be taller to provide sufficient vertical "stack" height.



Solar chimney at the computer building, York University

What is Radiative Cooling??

Transfer of heat from warmer surface to cooler surrounding surface (or outer space). It may be used to cool the building (where warm building surfaces radiate heat to the sky) or to cool the people (where the warm skin radiates heat to the cooler building surfaces -- to the cool walls of an underground building, for example).

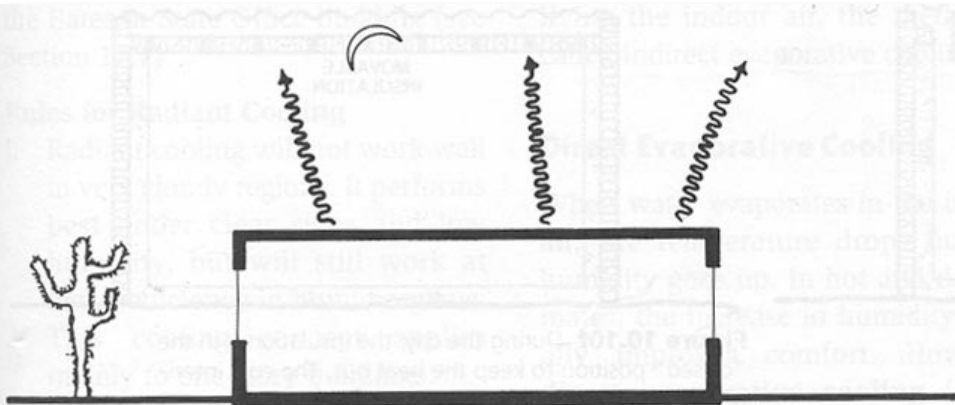

Figure 10.10a On clear nights with little humidity, there is strong radiant cooling.

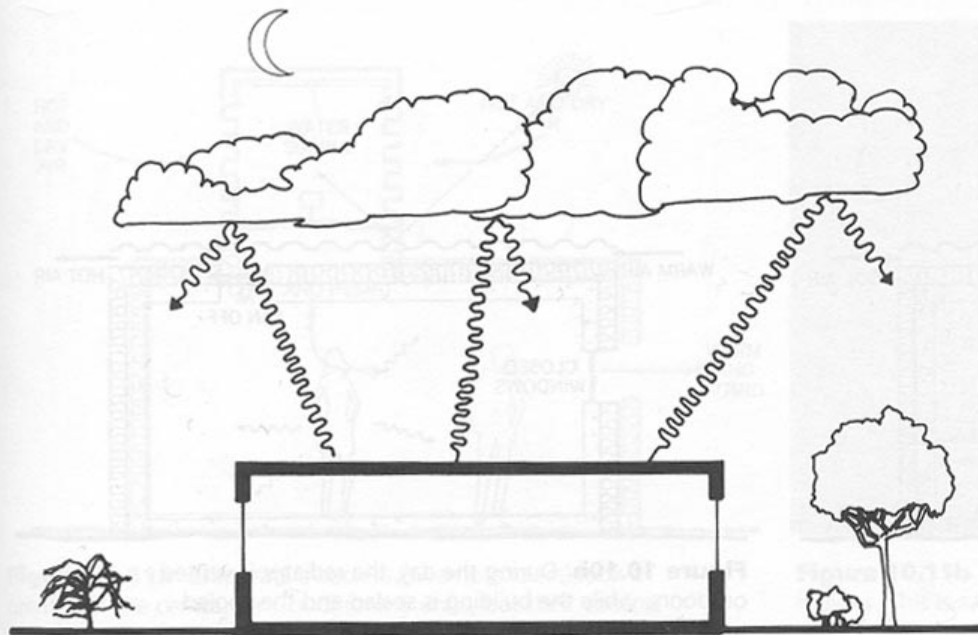
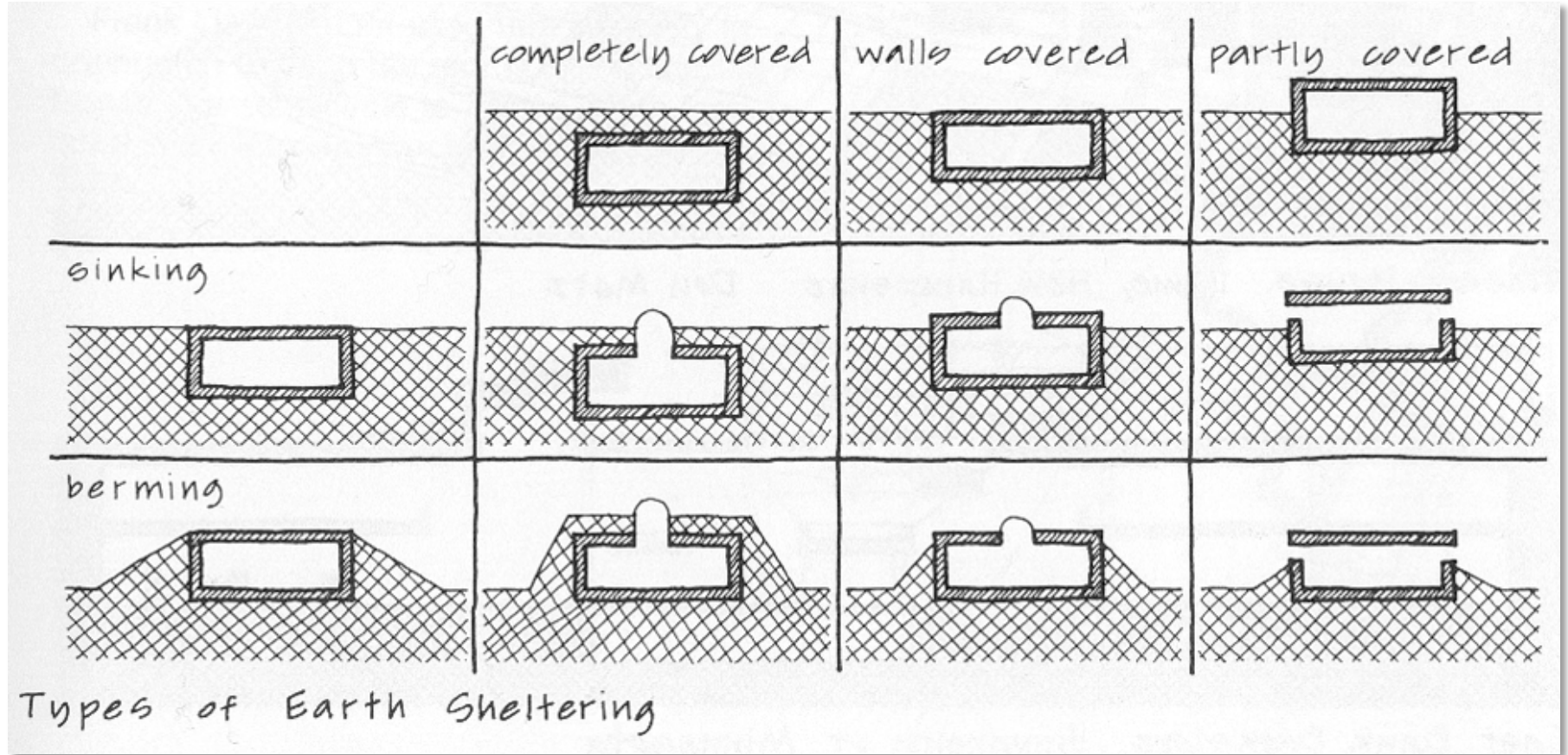
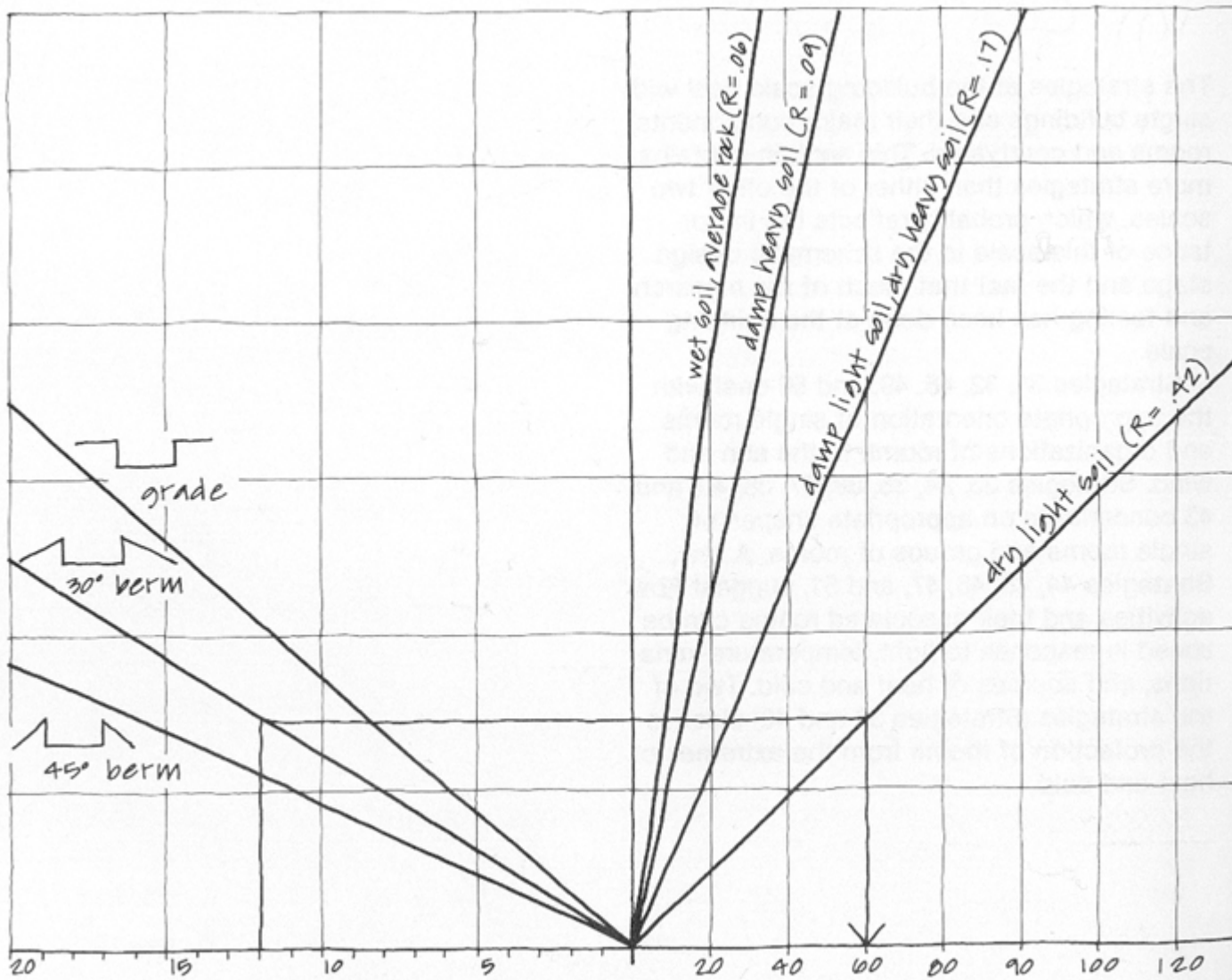

Figure 10.10b Humidity reduces radiant cooling, and clouds practically stop it.

Earth Berming used to cool buildings:







Depth Below Top of Grade or Berm - feet R at Given Depth Below Grade
 R Values for Bermed Walls

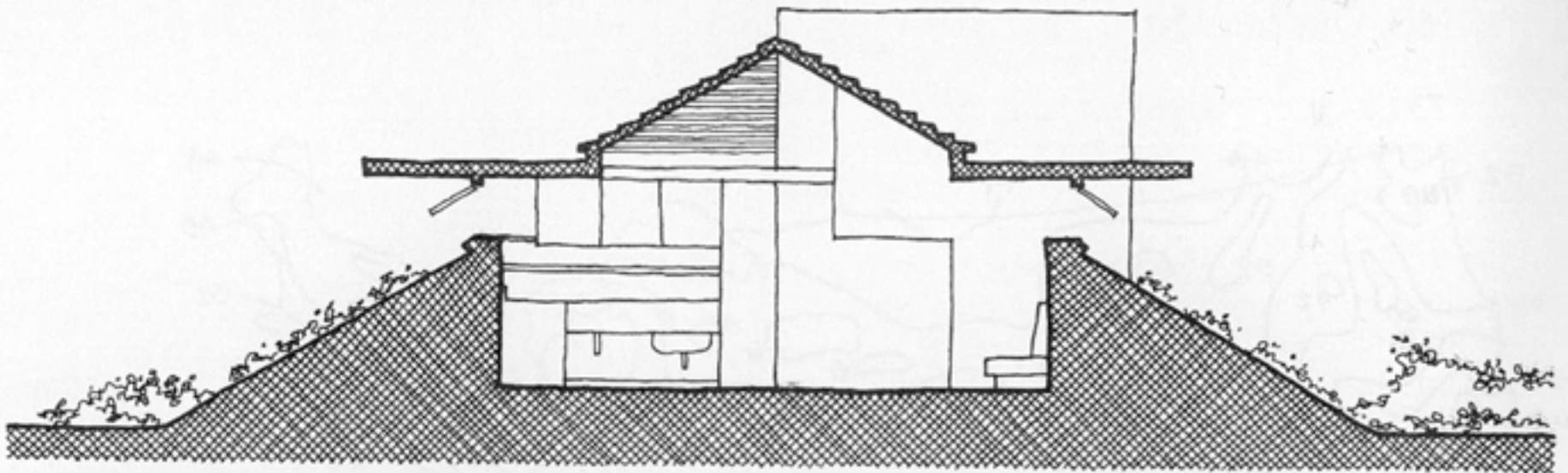

Cooperative Homesteads Project Detroit, Michigan Frank Lloyd Wright

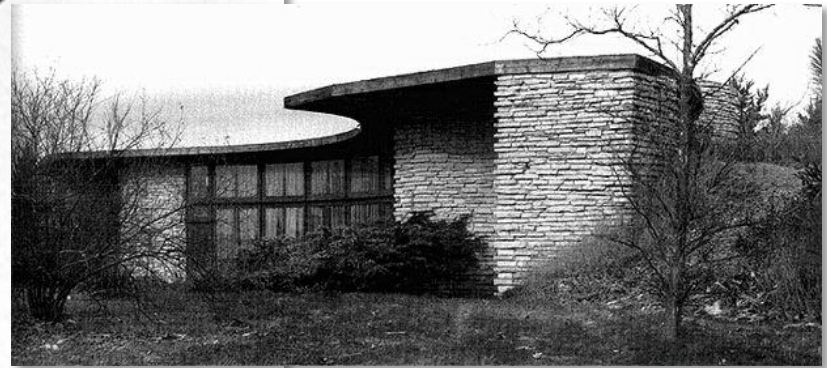
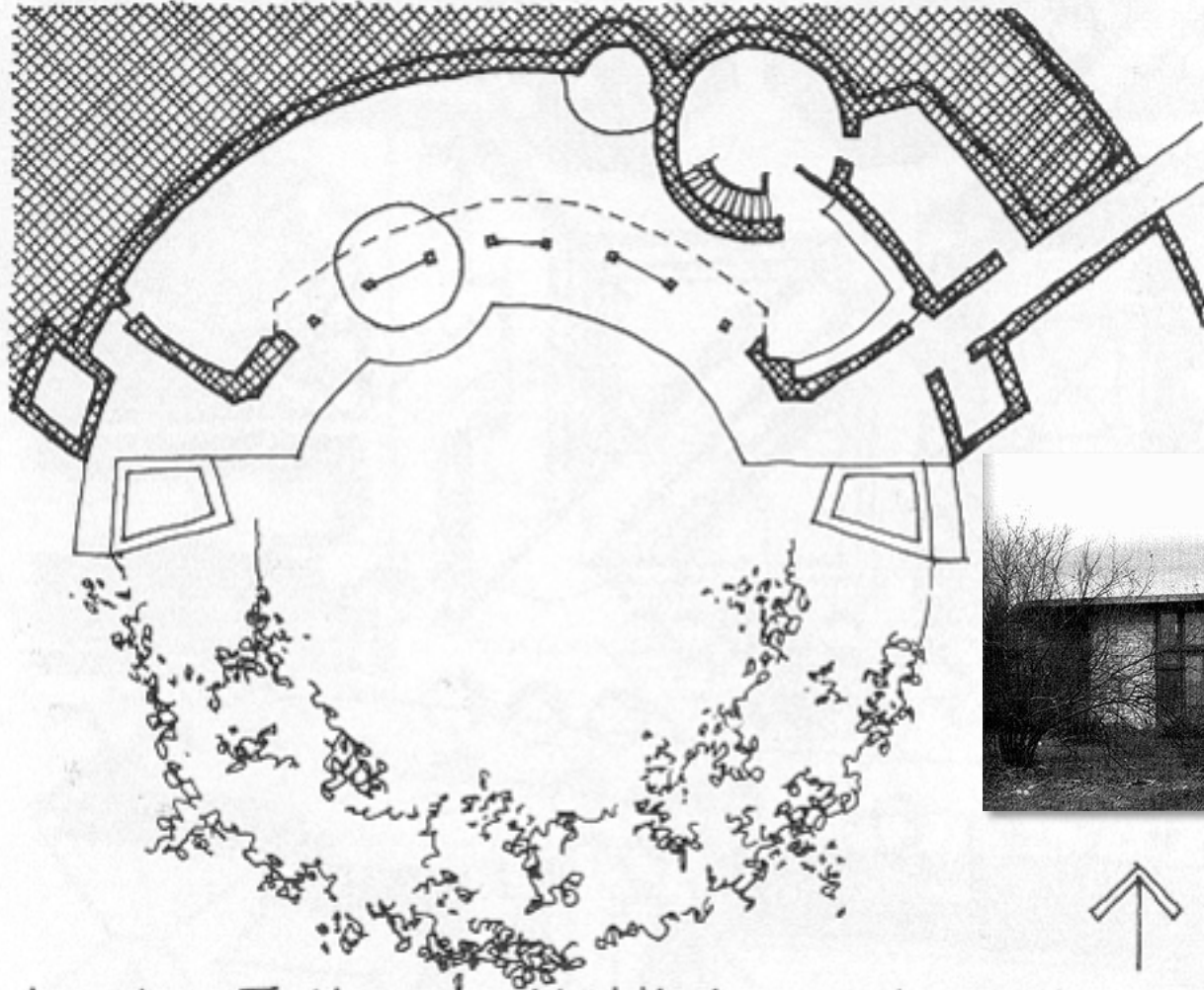

Jacobs II House Middleton, Wisconsin
F.L. Wright

SWL

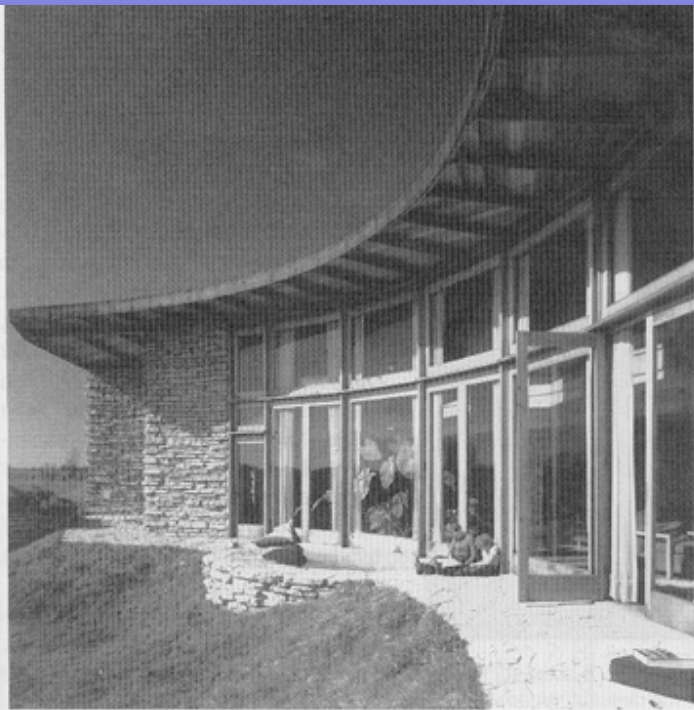

Figure 7.3a The Jacobs II House, Architect, Frank Lloyd Wright, Madison, WI circa 1948. (Photograph by Ezra Stoller © Esto.)

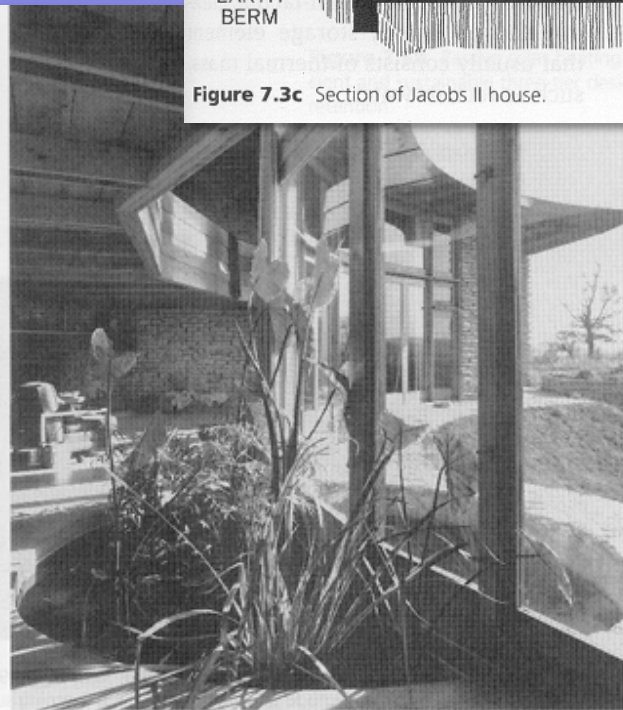

Figure 7.3d Interior view of Jacobs II House. (Photograph by Ezra Stoller © Esto.)

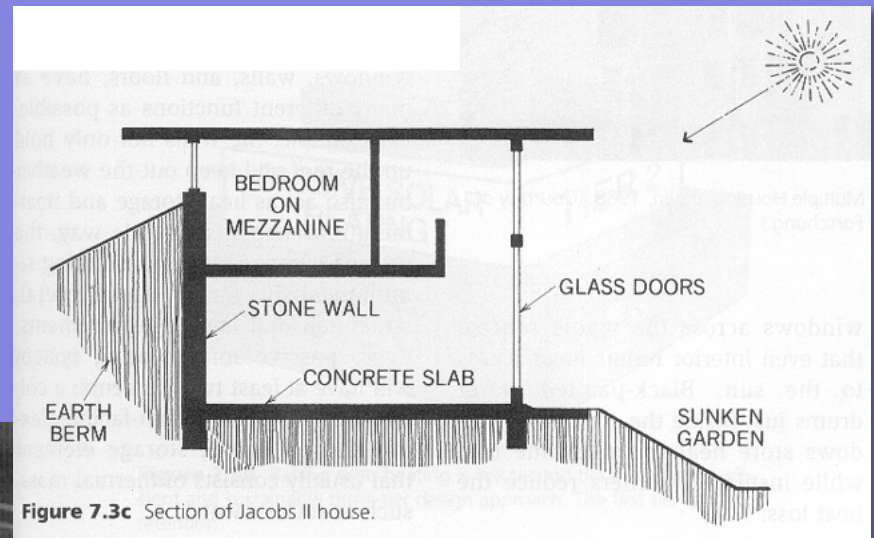
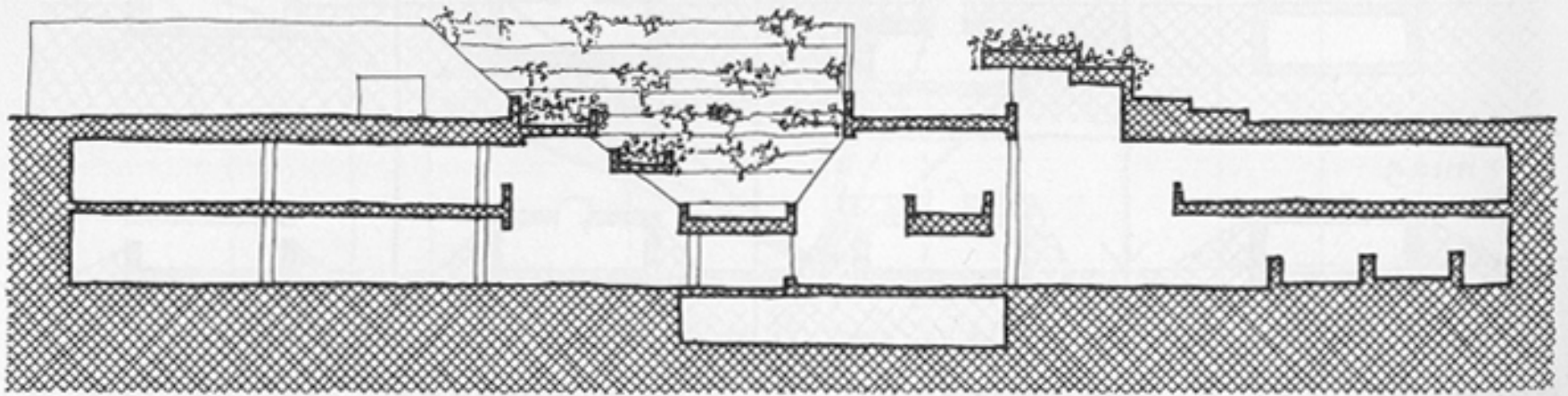
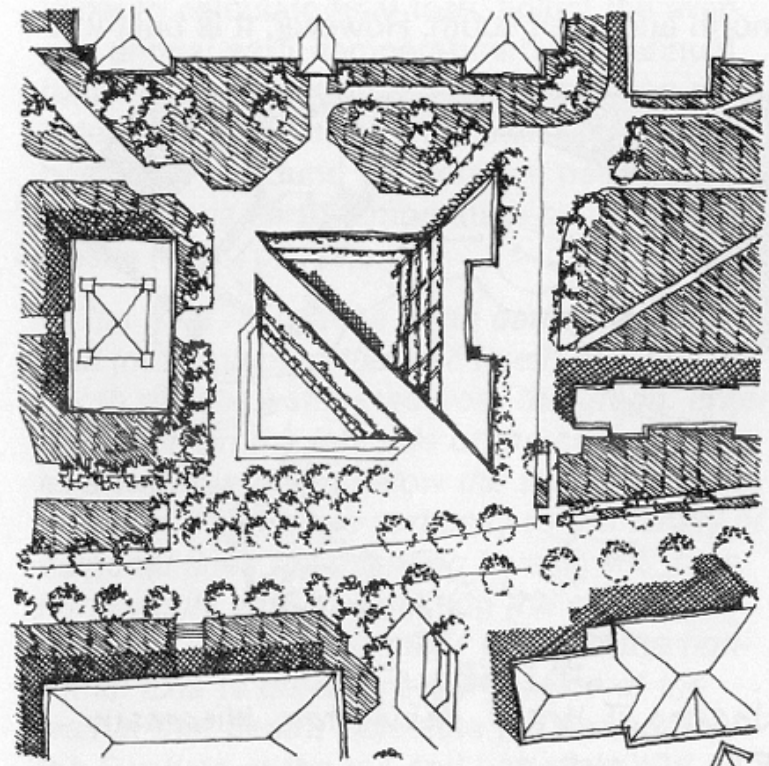

Figure 7.3c Section of Jacobs II house.



East Bank Bookstore University of Minnesota
Myers & Bennett Architects



SWL

East Bank Bookstore University of Minnesota
Myers & Bennett Architects



Special Roofs:

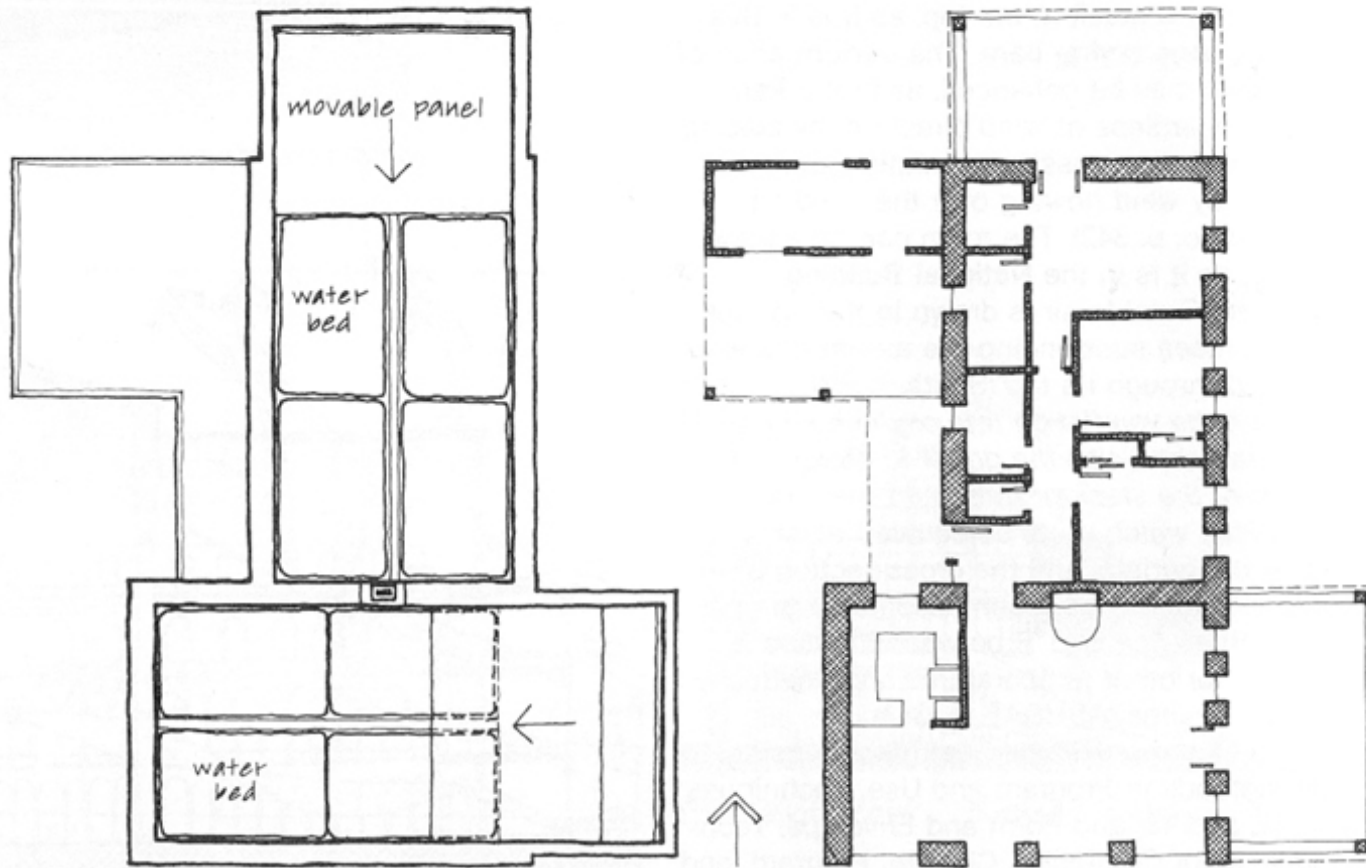

Roof Plan

Sunstone Phoenix, Arizona Daniel Aiello

Sunstone Phoenix, Arizona Daniel Aiello

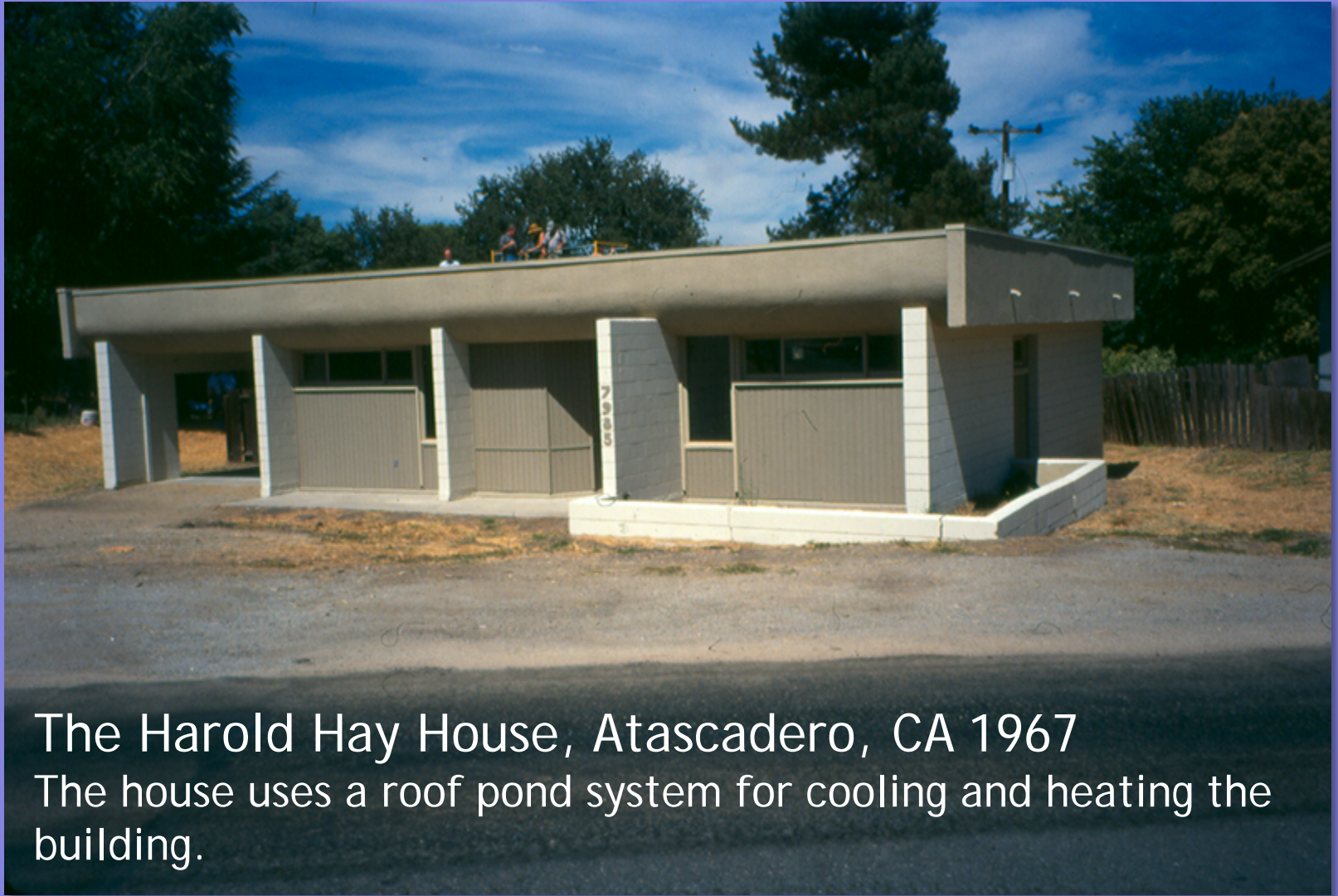

The Harold Hay House, Atascadero, CA 1967

The house uses a roof pond system for cooling and heating the building.

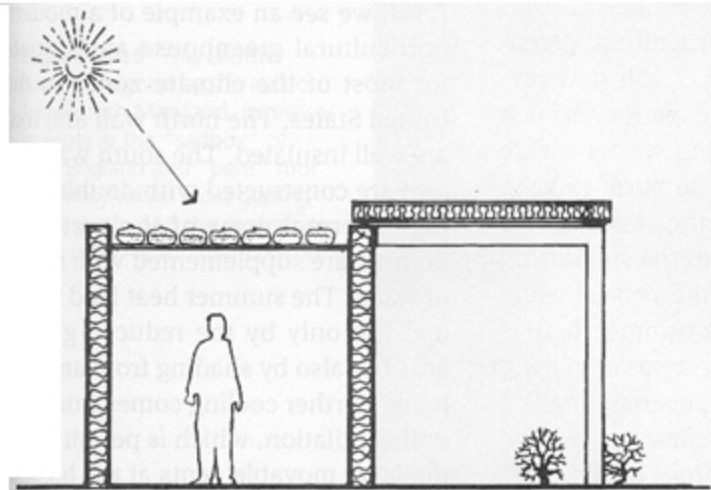
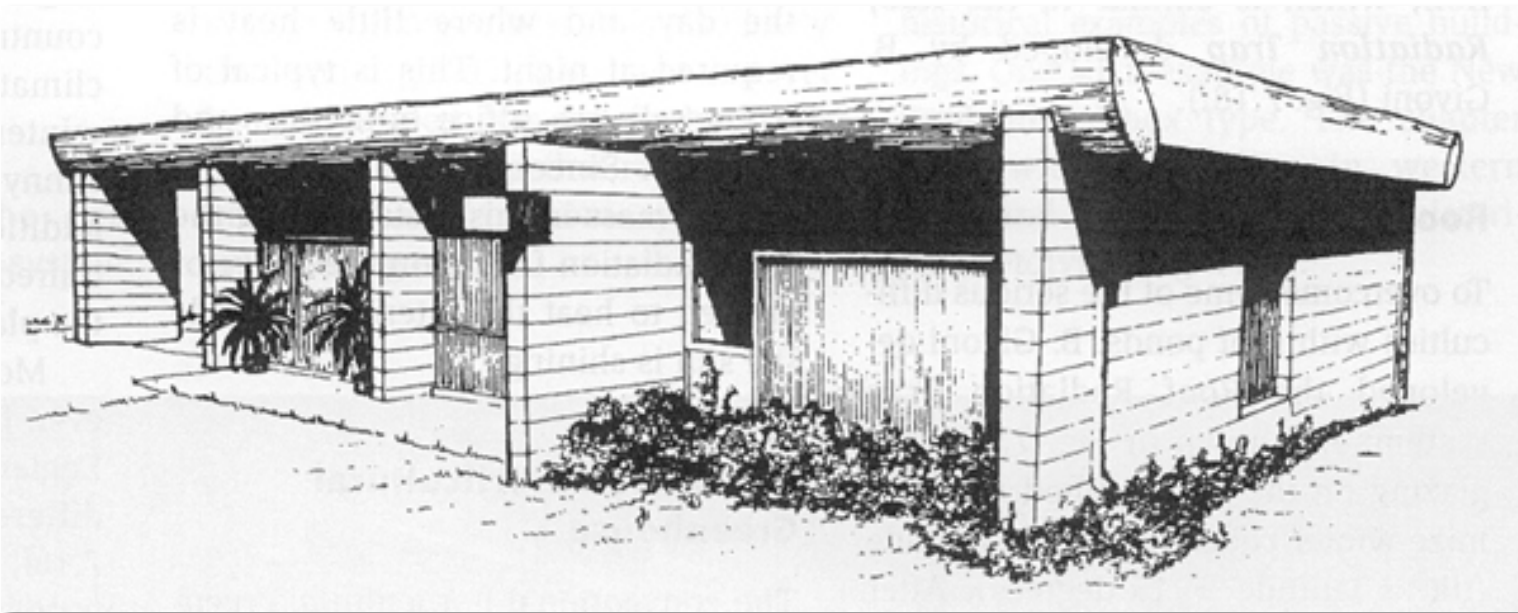

Figure 7.18d During the winter day, the black plastic bags of water are exposed to the sun, in the roof-pond system.

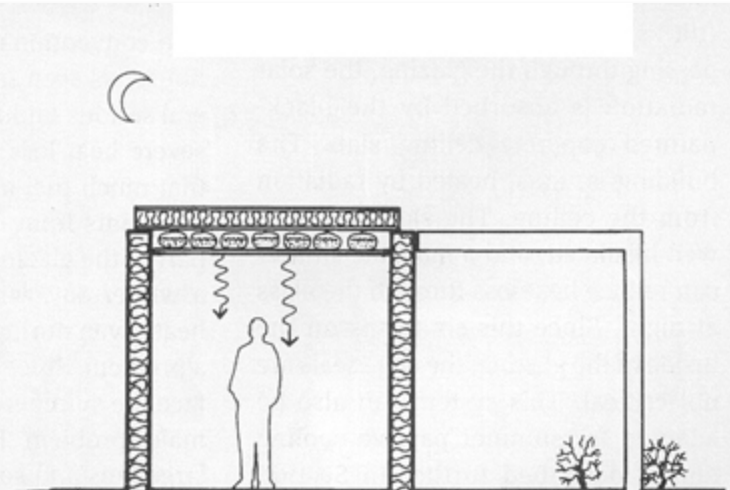

Figure 7.18e During the winter night, a rigid insulation panel is slid over the water.

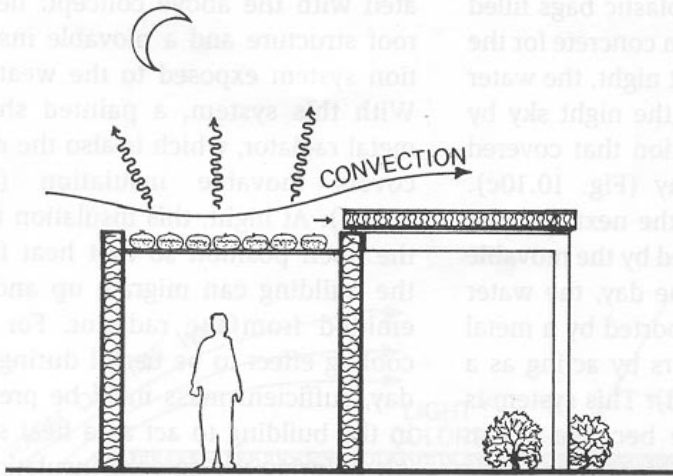
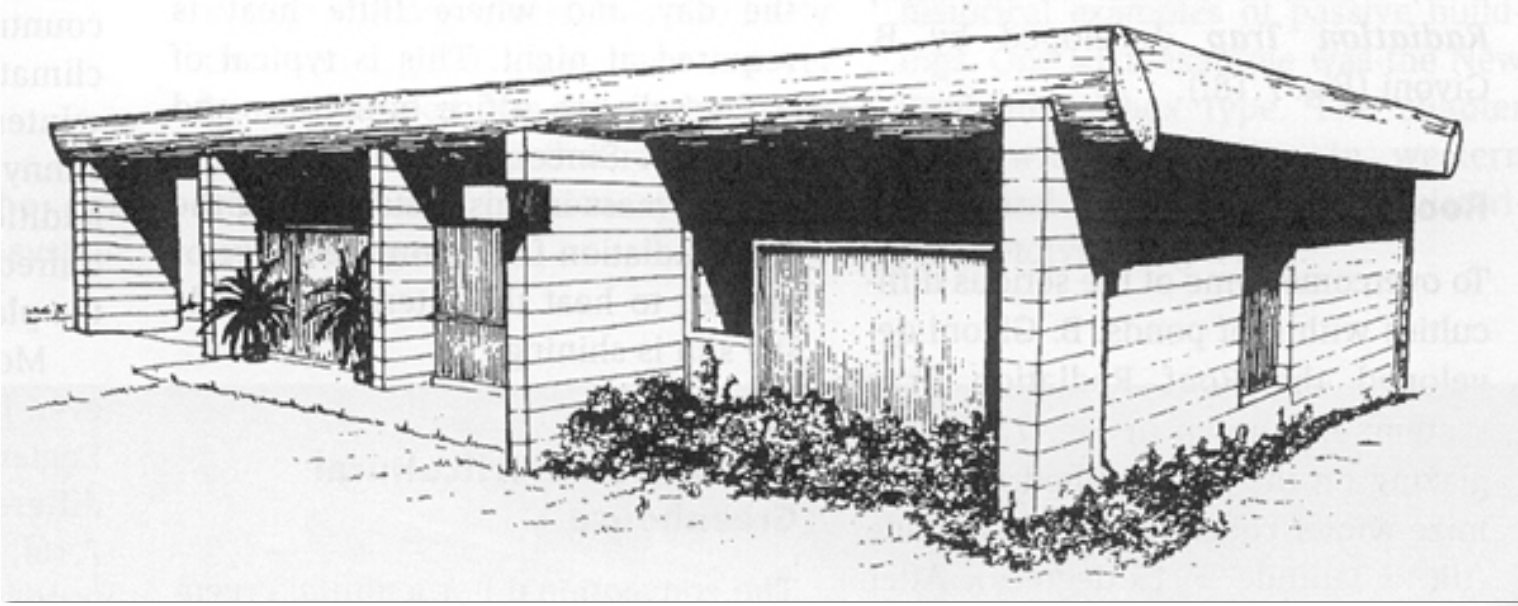

Figure 10.10c During a summer night, the insulation is removed and the water is allowed to give up its heat by radiant cooling.

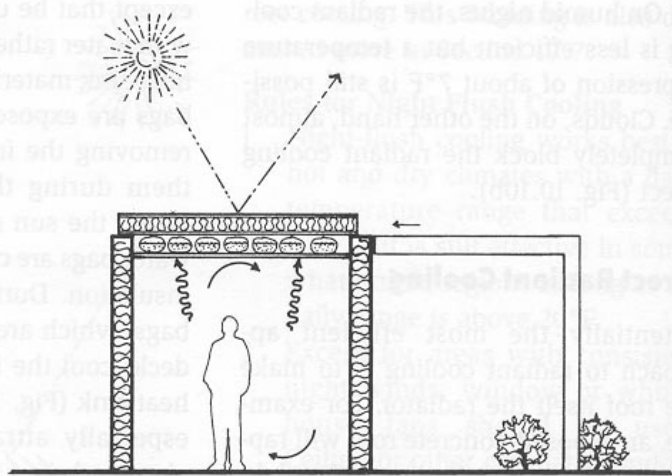

Figure 10.10d During a summer day, the water is insulated from the sun and hot outdoor air, while it acts as a heat sink for the space below.



The front of the building faces south. Main structure is concrete block shear walls with a steel pan roof.



Interior of the house. Concrete block is left exposed. Steel pan roof spans between the load bearing walls. That is Harold Hay at the left of the image.





The steel pan roof is used to transfer the heat from the water bags on the roof to the room, or from the room to the water bags, as a function of the indoor and outdoor temperatures.



View at the back/north side of the house. Here you can see the black bags that hold the water partially exposed to the sun. Since it is 95F outside and only 85F inside, this exposure is causing heat transfer to the interior.

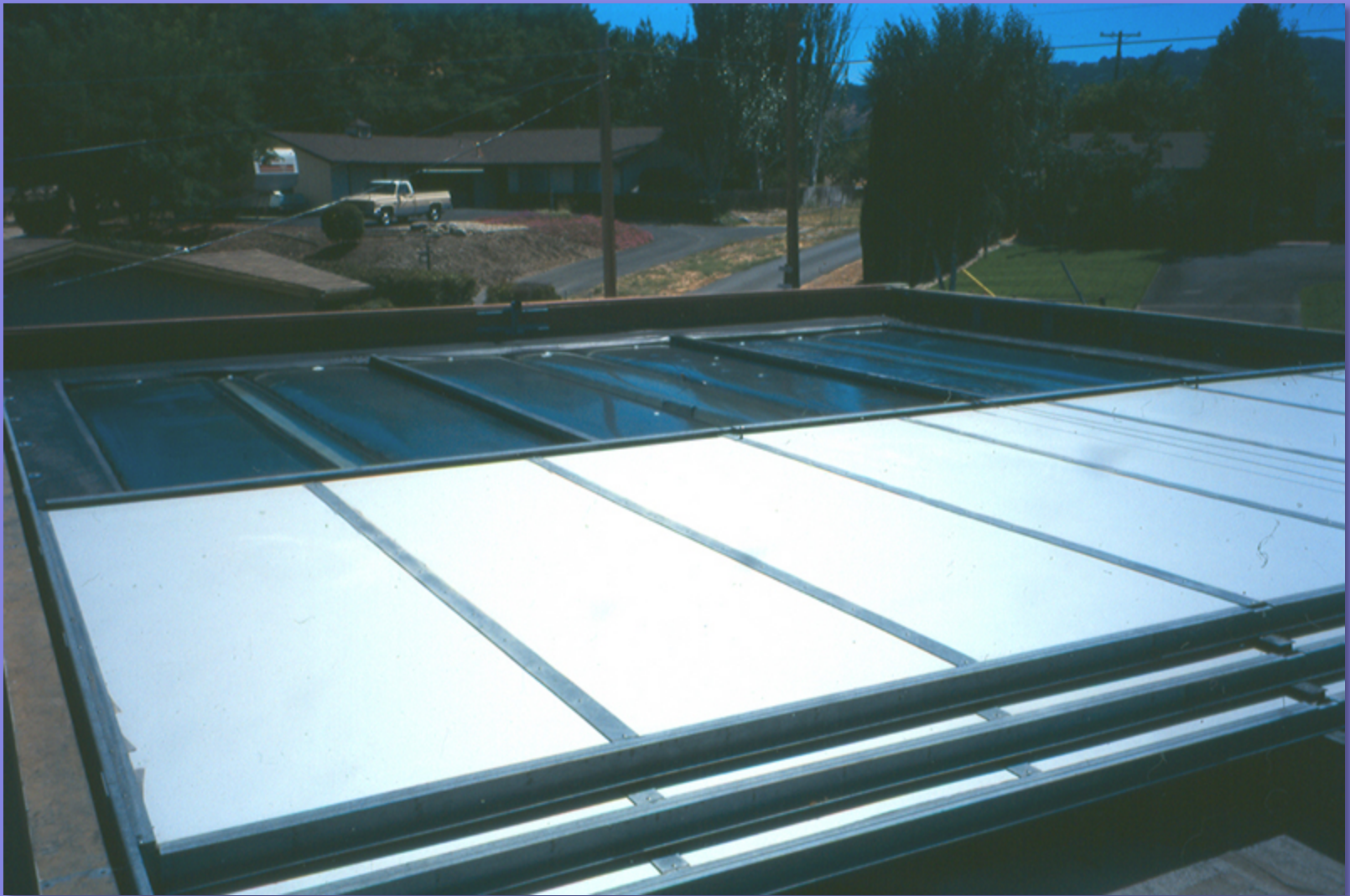

Here we can see the insulating cover panels being pulled back to expose the pond roof to the sun.

Roof panels fully open and stacked over the carport.



Roof panels commencing closure.



Roof panels are almost fully closed, preventing heat transfer to the interior.



Green roof on the Vancouver Public Library

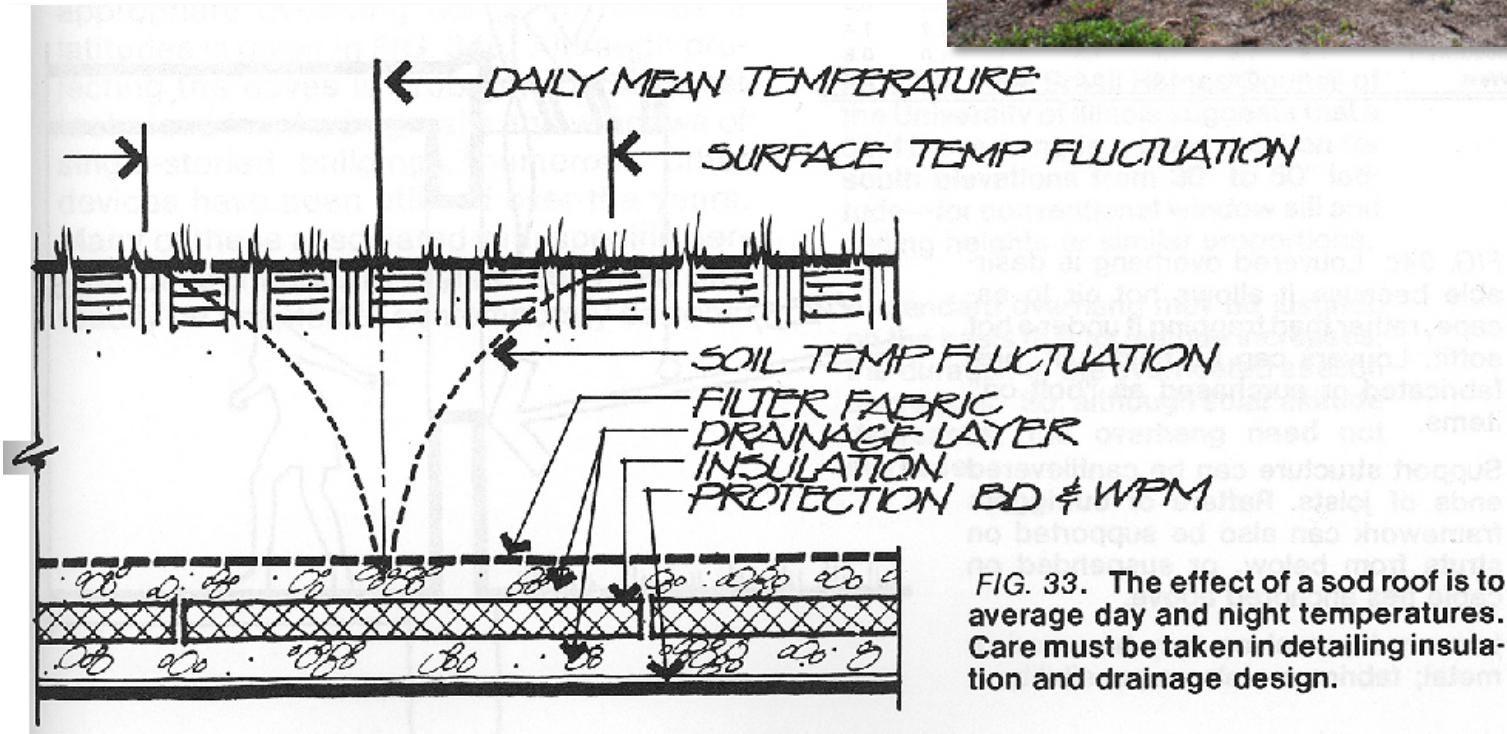

FIG. 33. The effect of a sod roof is to average day and night temperatures. Care must be taken in detailing insulation and drainage design.



Green roof on the Stantec Building, Edmonton, Winter 2005



Green roof on the New Canadian War Museum, Ottawa



Perimeter Institute, Waterloo

What is Dehumidification Cooling??

The removal of water vapour from room air by dilution with drier air, through condensation, or dessication.

This process can be very difficult to achieve in a *passive way* in hot humid climates where there is no dry air available to use to dehumidify and the relative humidity is above 80%.

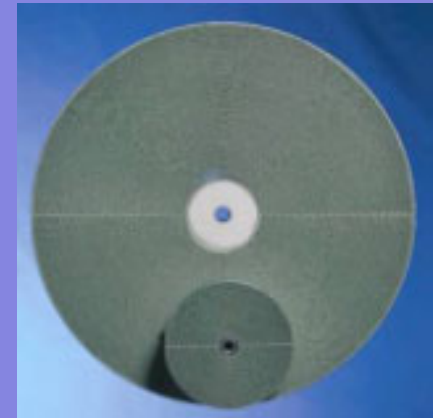
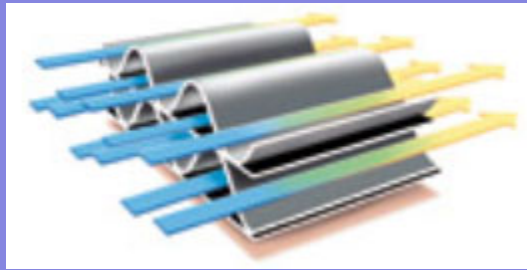

Integrated desiccant dehumidification and vapor compression cooling technologies, utilizing SSCR rotors.

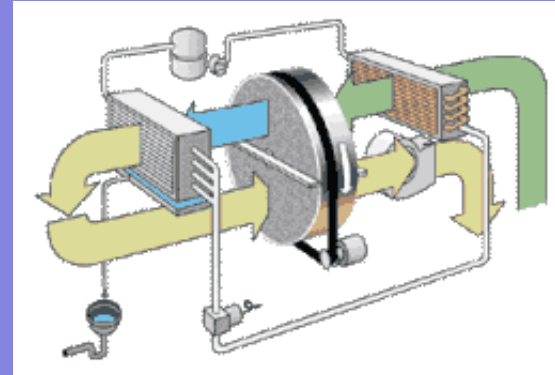
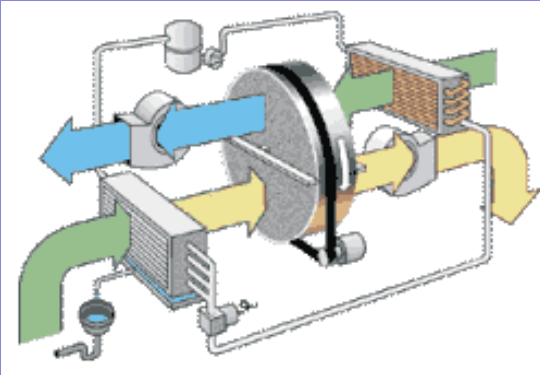

EconoSorb:

Energy consumption is 25% of a standard desiccant dehumidifier and 50% of a mechanical unit rated at 68 F and 60% RH.

Available in standard and tropical designs.

Capacity range: 500 to 20,000 scfm. 20 to over 400 lbs/hr of water removal

CoolSorb:

Energy consumption is 33% of a standard desiccant dehumidifier and 60% of a mechanical unit rated at 68 F and 60% RH, requiring only one air stream.

Capacity range: 800 to 12,000 scfm. 8 to over 130 lbs/hr of water removal

What is Mass Effect Cooling??

The use of thermal storage to absorb heat during the warmest part of the day and release it during a cooler part. “Night flushing”, where cooler air is drawn through a building to exhaust heat stored during the day in massive floors and walls is an example of daily-cycle-mass-effect-cooling.

A good strategy to couple with direct gain passive solar systems that will tend to absorb heat from its thermal mass component during the day of hot cycles.

Night Flush Cooling

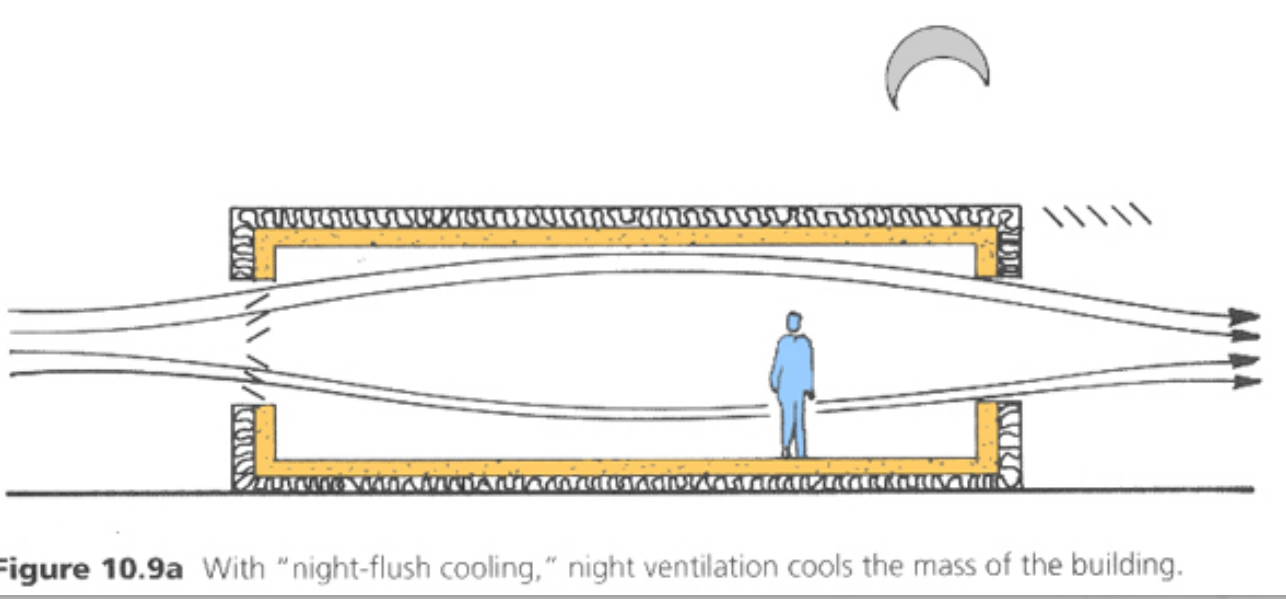

Figure 10.9a With "night-flush cooling," night ventilation cools the mass of the building.

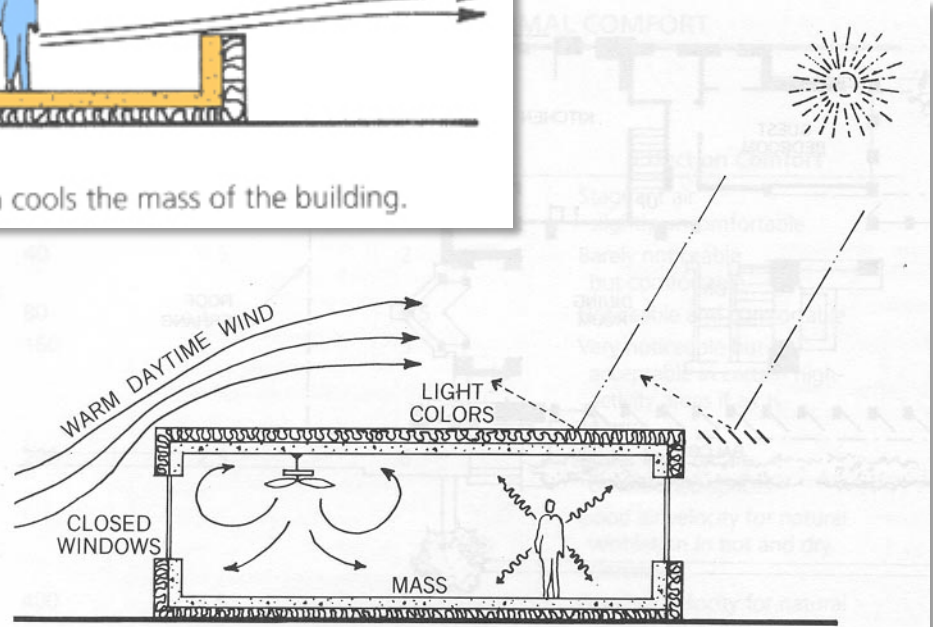

Figure 10.9b During the day, the night-flush cooled mass acts as a heat sink. Light colors, insulation, shading, and closed windows keep the heat gain to a minimum. Interior circulating fans can be used for additional comfort.

Night Flush Cooling

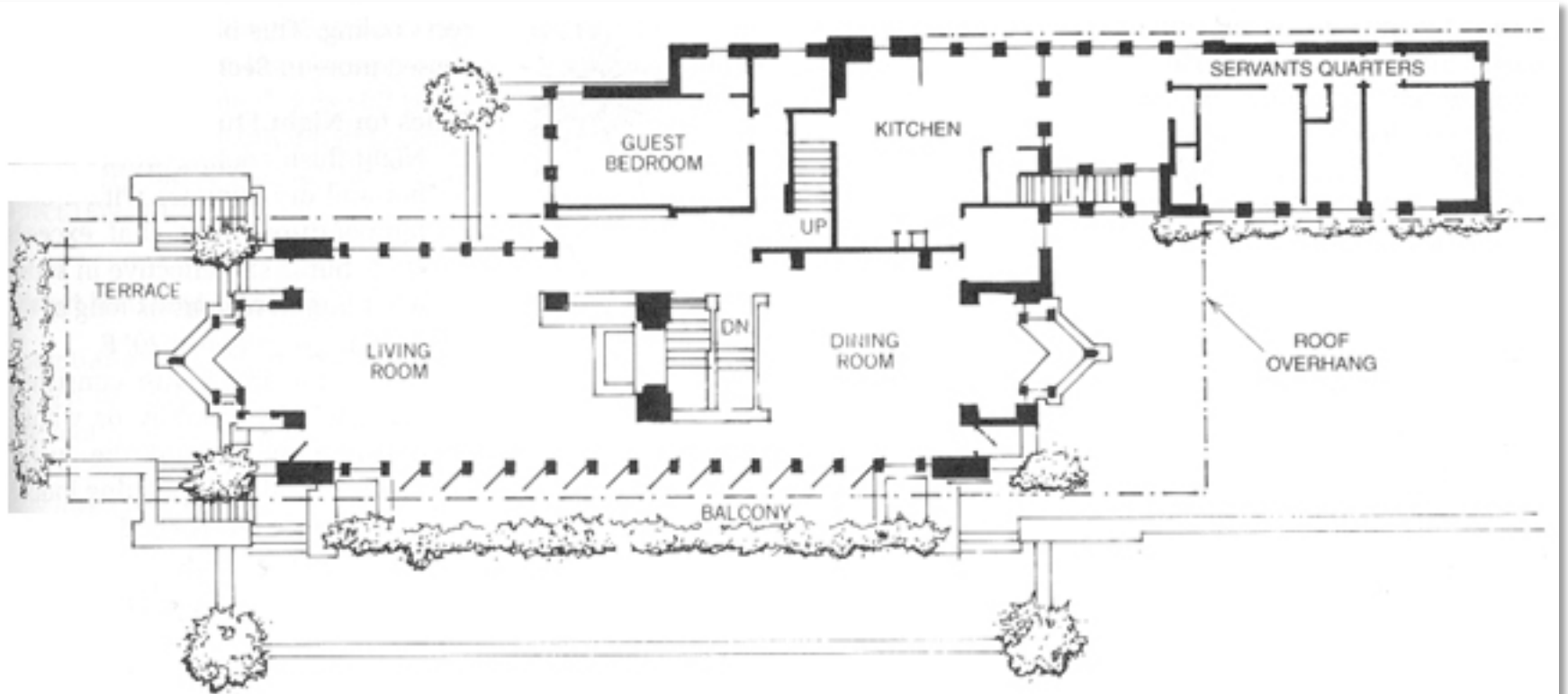
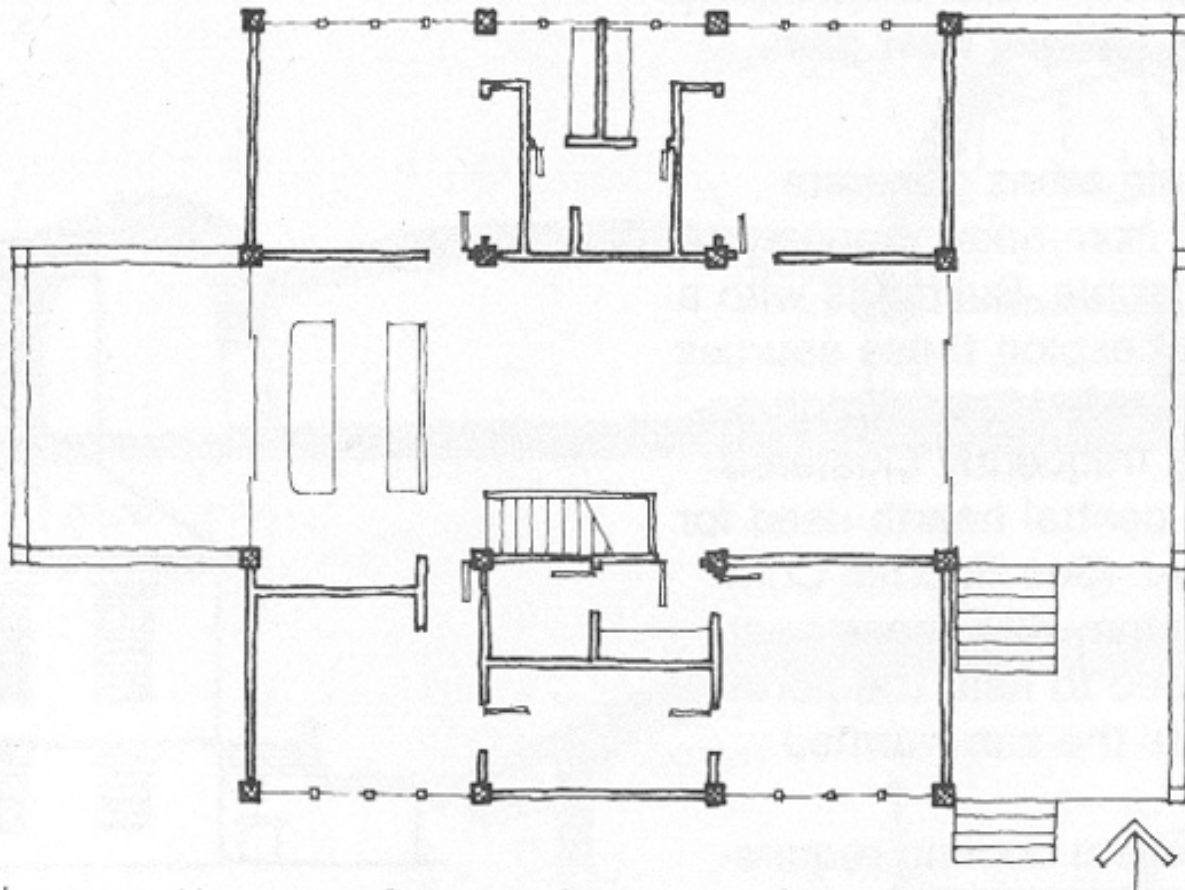
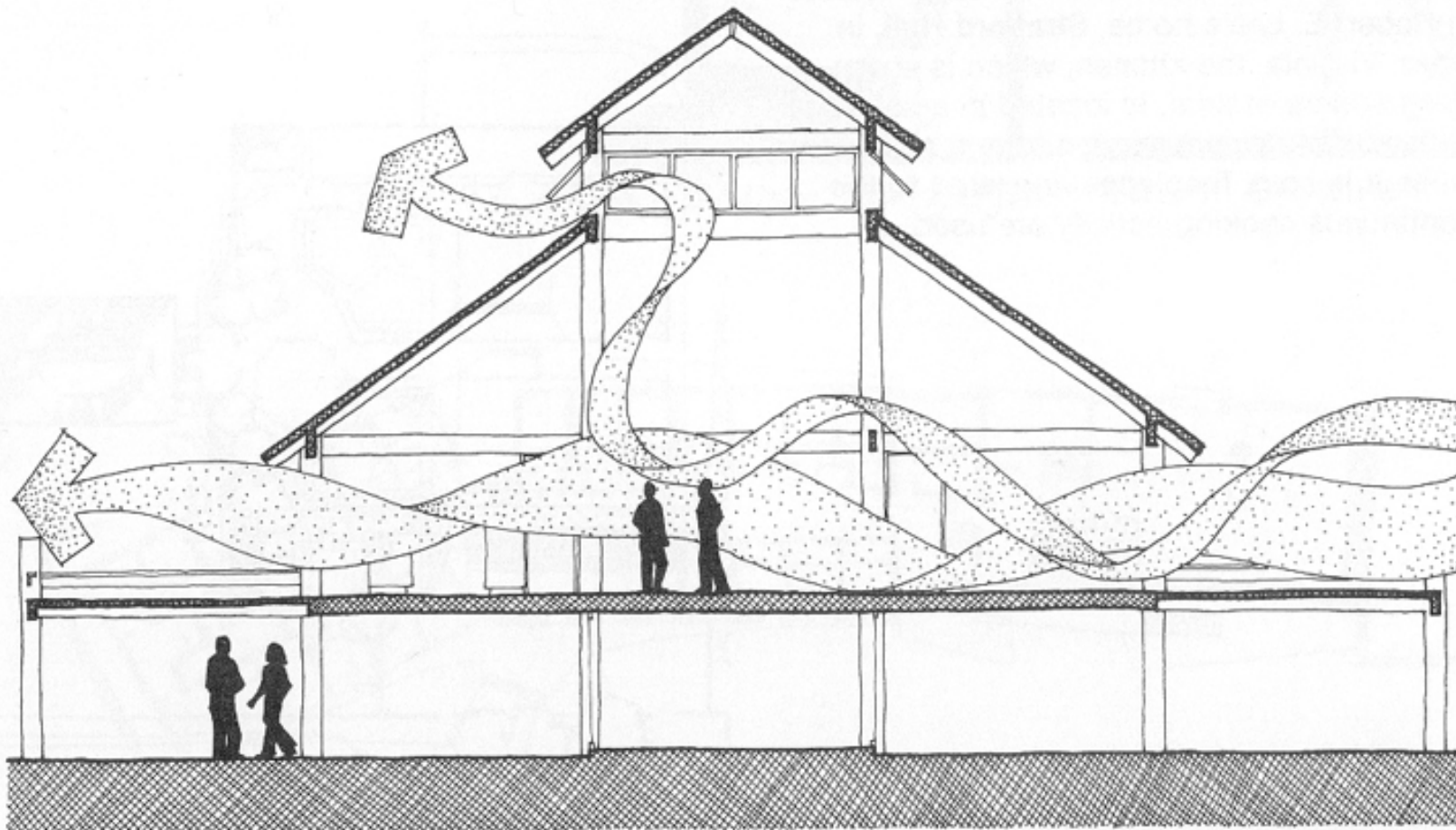

Figure 10.8b Frank Lloyd Wright's Robie House (1909) in Chicago had whole walls of doors and windows that opened for natural ventilation.





Logan House Tampa, Florida Rowe Holmes Assoc.



Logan House Tampa, Florida Rowe Holmes Assoc.

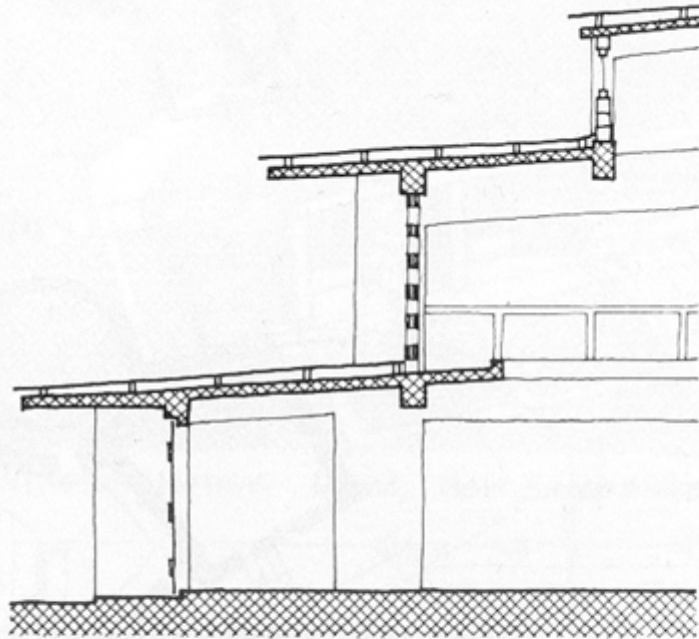

Church in the Philippines

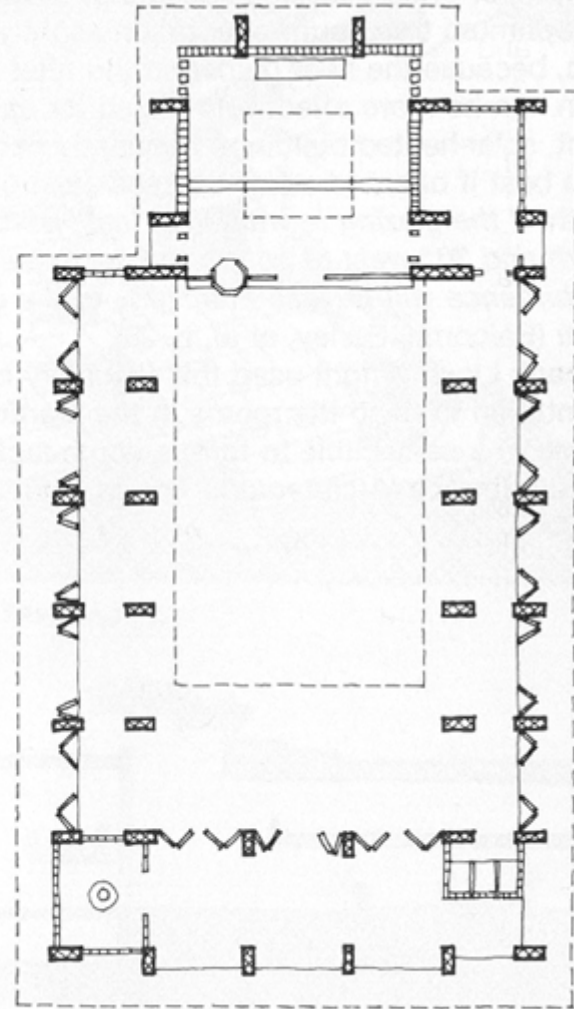

Church in the Philippines

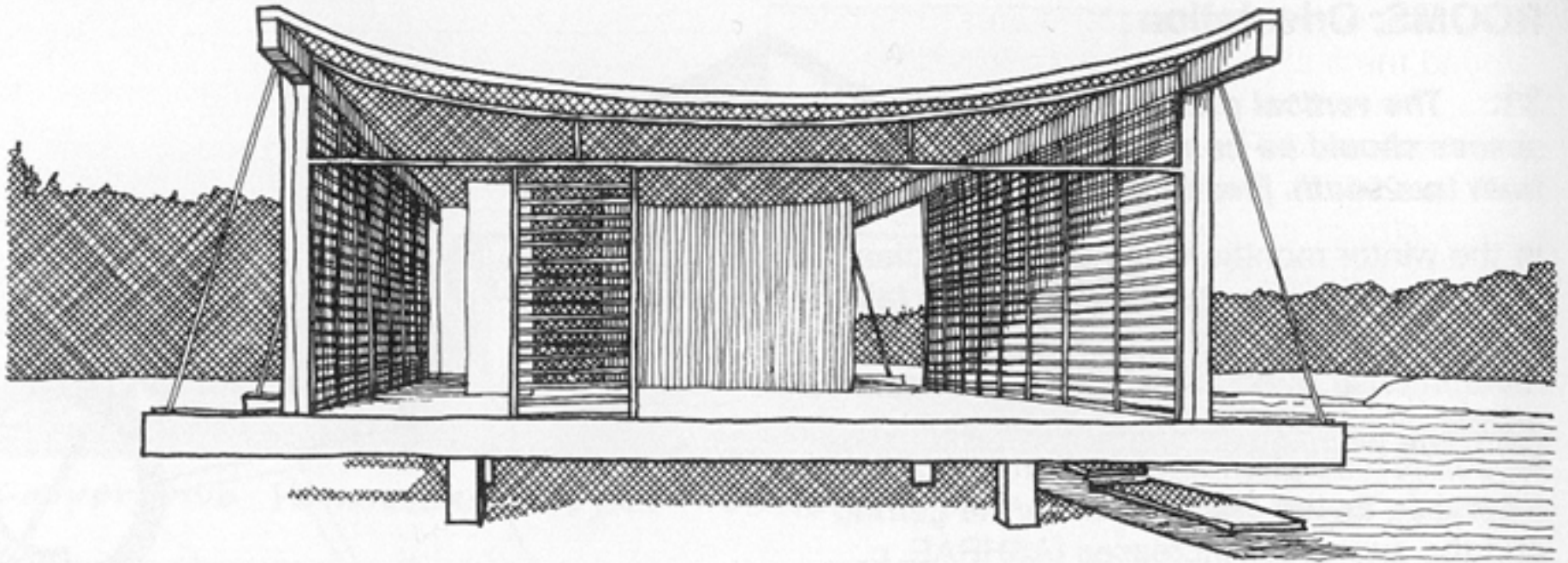

Cocoon House Sarasota, Florida Paul Rudolph

Magic Arrow Diagrams:

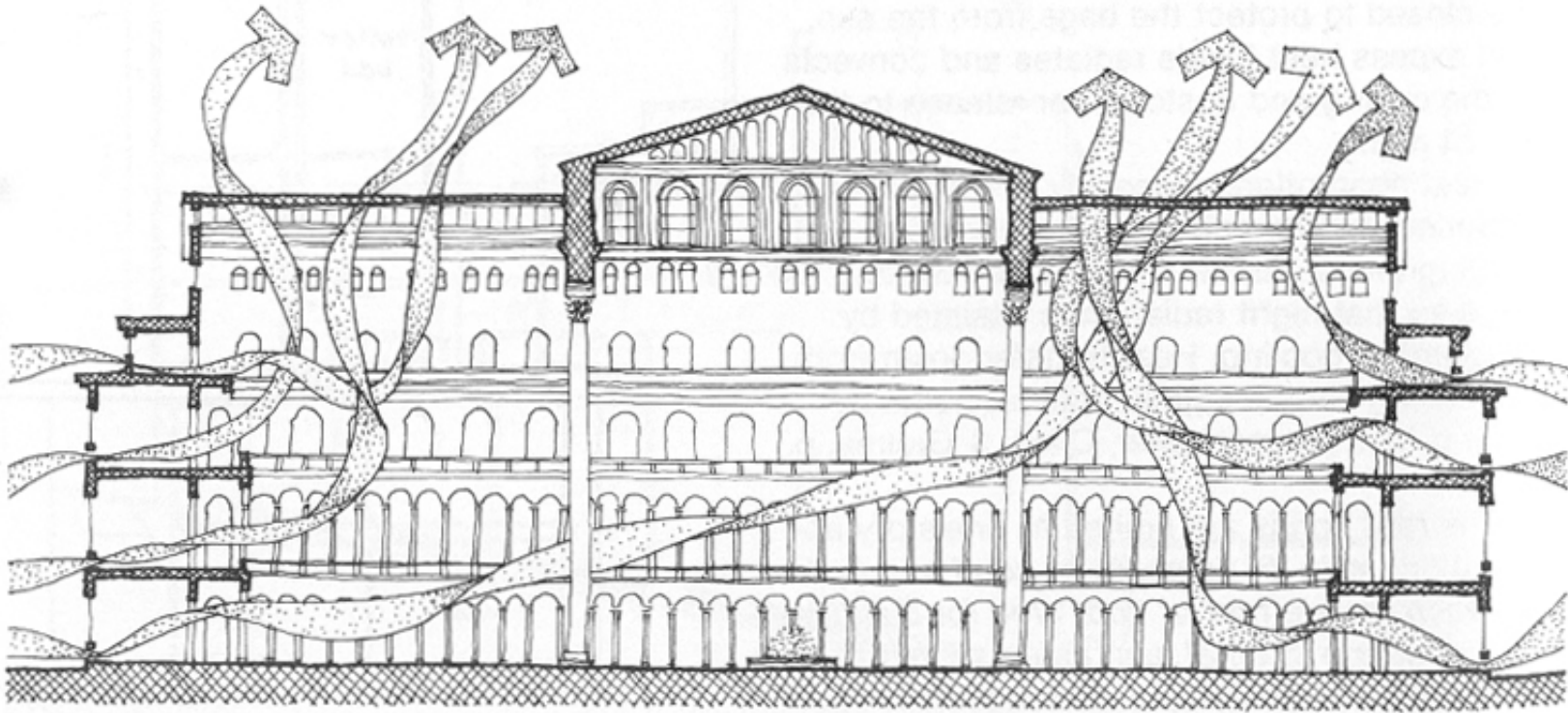

Pension Building Washington, D.C. Montgomery C. Meigs

You have to make them to explain this, and they sure had better be based on sound thought...

Stratification:

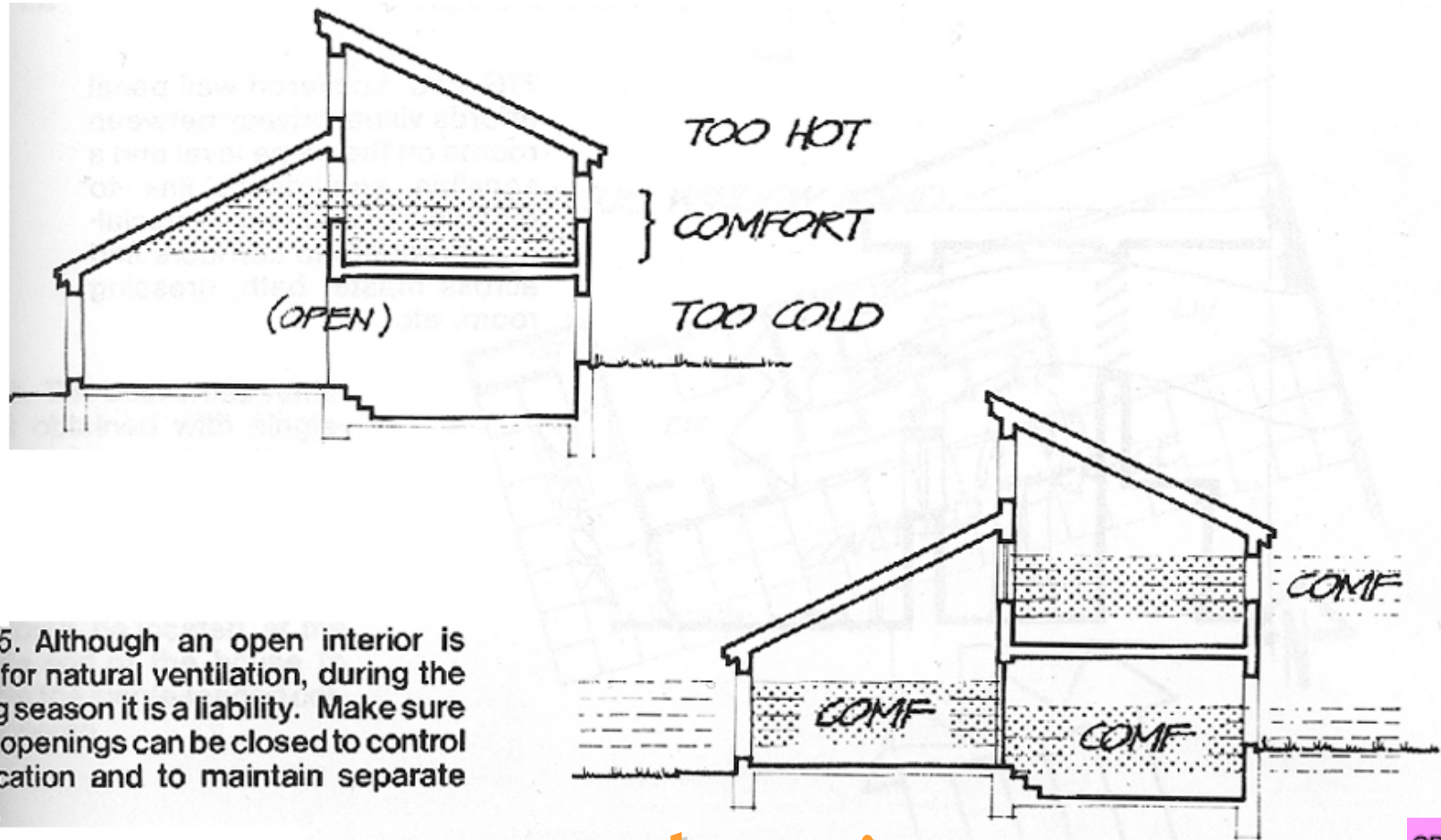

FIG. 25. Although an open interior is useful for natural ventilation, during the heating season it is a liability. Make sure that all openings can be closed to control stratification and to maintain separate zones.

...return to heating season...

Remaining “Wicked Problems”

Natural Ventilation

- A key way to reduce the energy required to power a building is via the elimination of A/C
- Not all buildings can tolerate the resulting humidity or fluctuations in interior environment that can result from no A/C
- Urban environments can be too “dirty” for natural ventilation
- Urban environments can be too noisy for natural ventilation