

Renewables: Supplementing the Natural with Active Systems

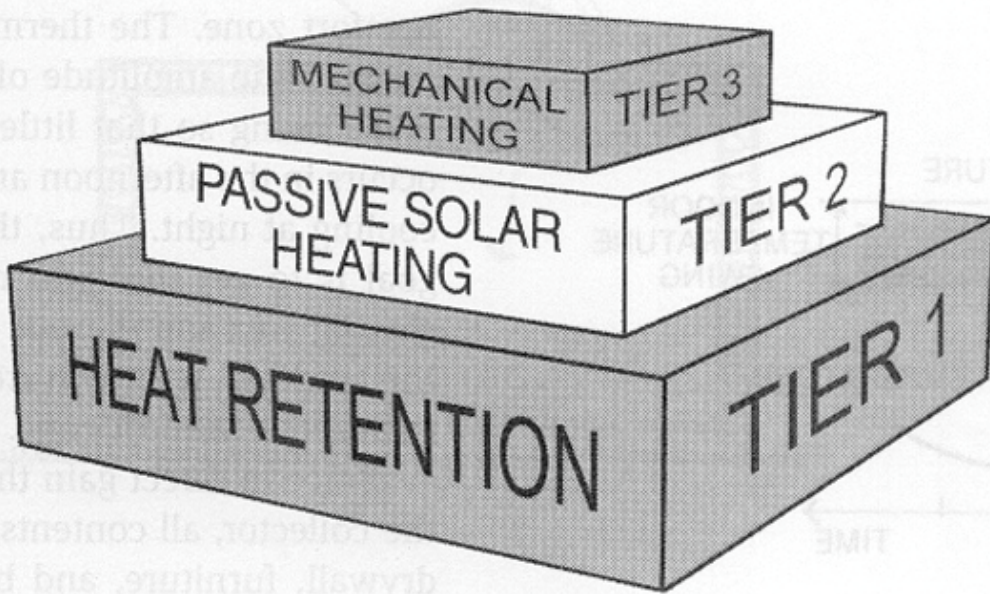

Photovoltaics, wind, geothermal,
radiant floor heating, solar thermal

Passive vs Active Systems



Heating Mode

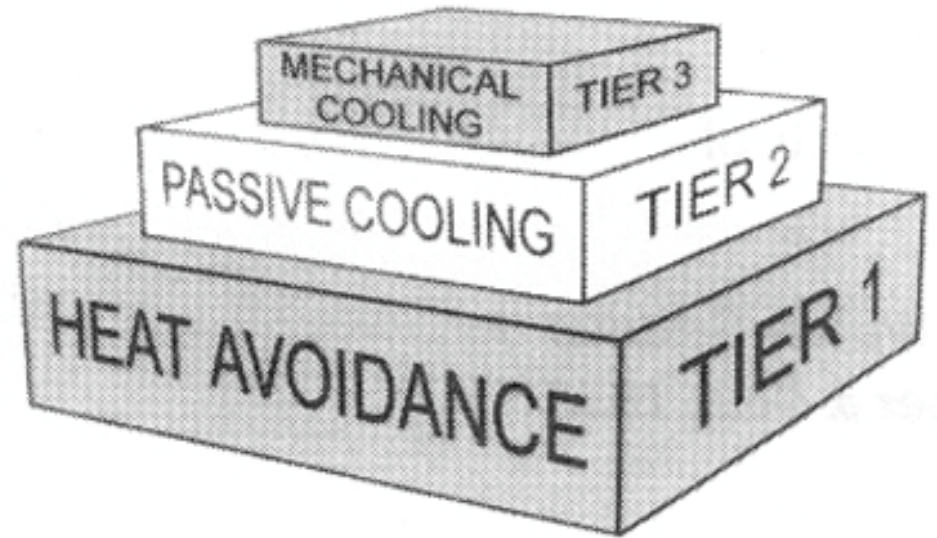

Cooling Mode

Seeking well integrated solutions



Renewables

Renewable energy sources, such as

- **solar** to generate electricity and hot water, as well as
- **wind**, to generate electricity,
- **geothermal**, to create heating,

are increasingly being looked to as a means of reducing reliance on NON renewable energy sources such as fossil fuels of all types.

Renewables:

Renewables have the advantage of being in

- INFINITE in supply,
- FREE (ie. Sun and wind).

What is difficult at present is the cost of the means required to convert both solar and wind to something “more useful” to the built environment.

As a result, these systems are only implemented where conditions are IDEAL, as a way to increase efficiency and reduce costs.

Systems we are going to look at:

Photovoltaic Systems: standard and BIPV (building integrated photovoltaics)

Solar thermal: concentrating units that use the sun

Wind energy: single turbines or wind farms

Geothermal: using the temperature of the ground beneath the building to preheat or pre-cool

Radiant Floor Heating systems: mostly because they are a natural extension of the principles of geothermal heat transfer.

PV systems



Photovoltaic Systems:

The Science of Photovoltaics

Photovoltaic science is the science of turning energy produced from the sun into electricity. Edmond Becquerel discovered the concept known as the photovoltaic effect in 1839. However, the first positive/negative (p/n) junction solar cell was not created until 1954 at Bell Labs.

Definition

Photovoltaics are solid-state semiconductor devices that convert light directly into electricity.

They are usually made of silicon with traces of other elements and are first cousins to transistors, LEDs and other electronic devices.

Global Solar Photovoltaic (PV) Production

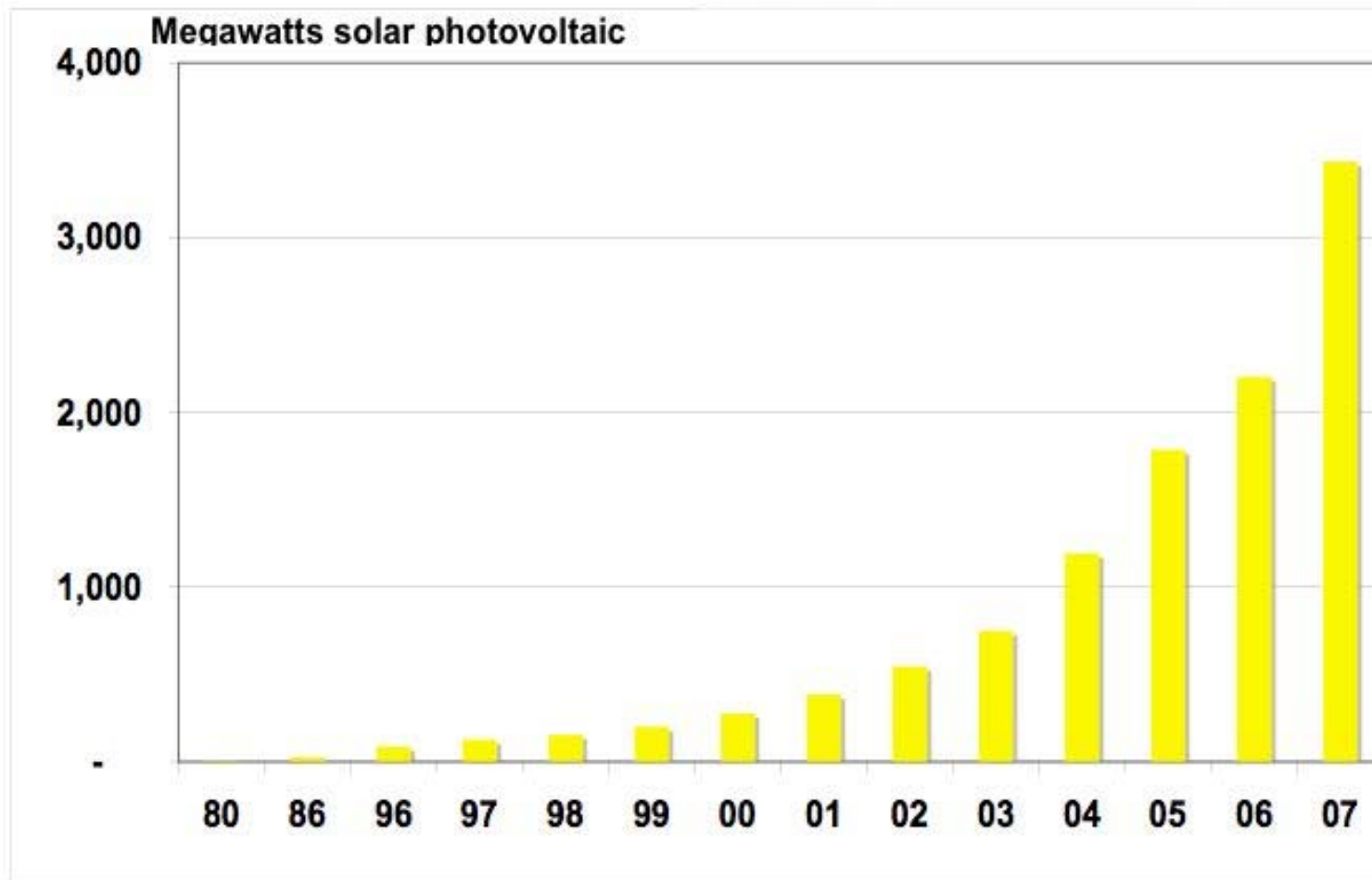

Source: O'Meara, Prometheus Institute, Solarbuzz

World PV production 1998 to 2003

Production of PV has increased dramatically since the initial sustainable design conference in 1987. The efficiency has increased and the costs have decreased.

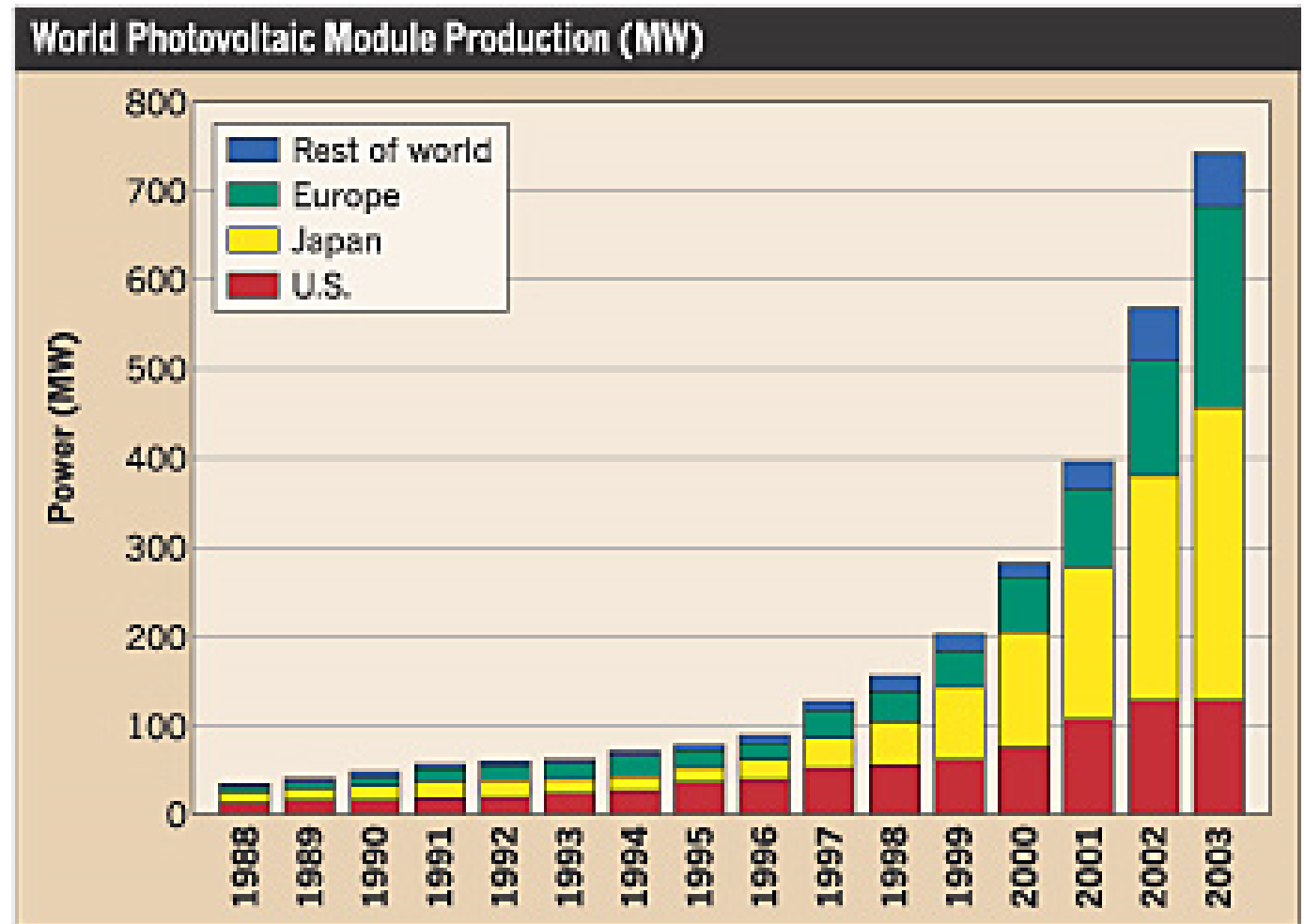

World PV production 2006 to 2012

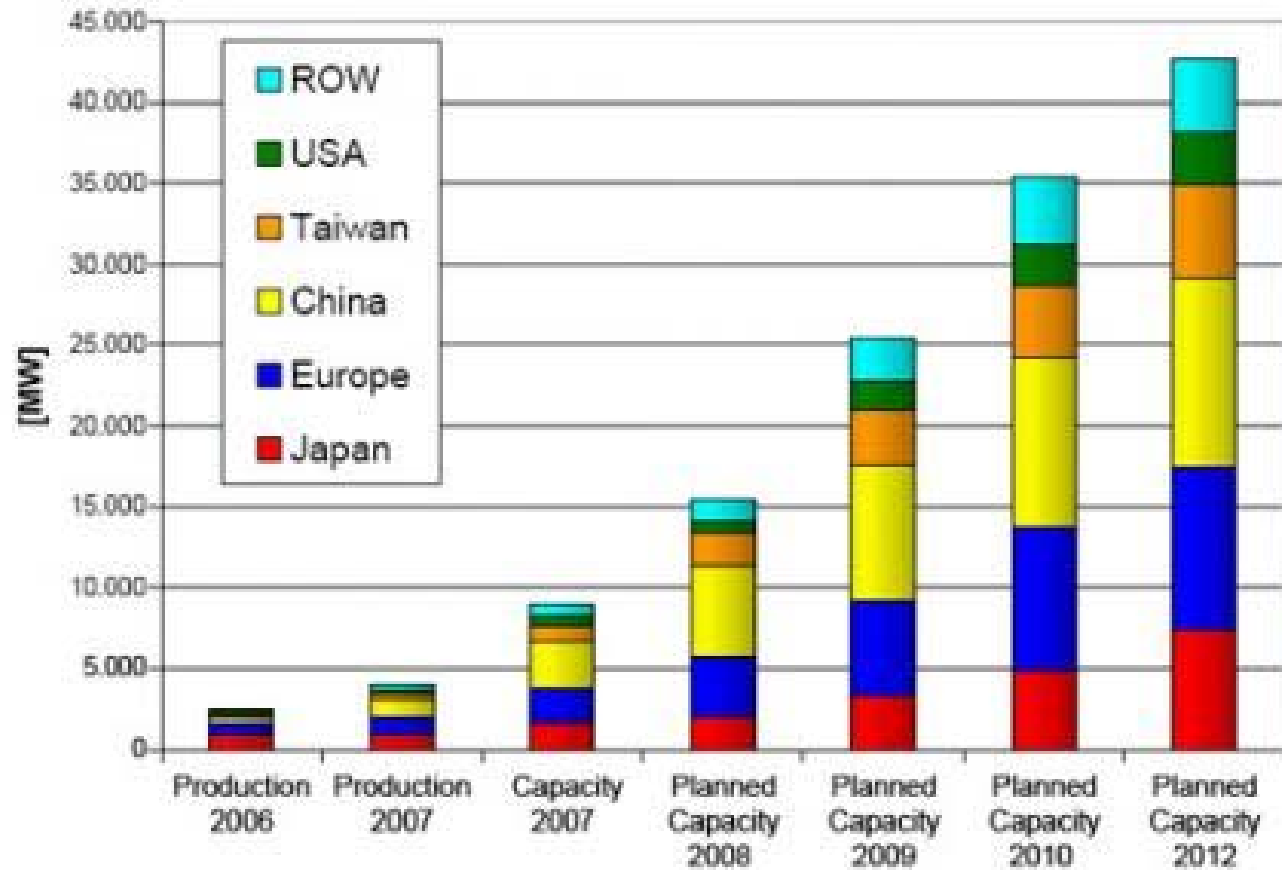

Solar PV industry outlook

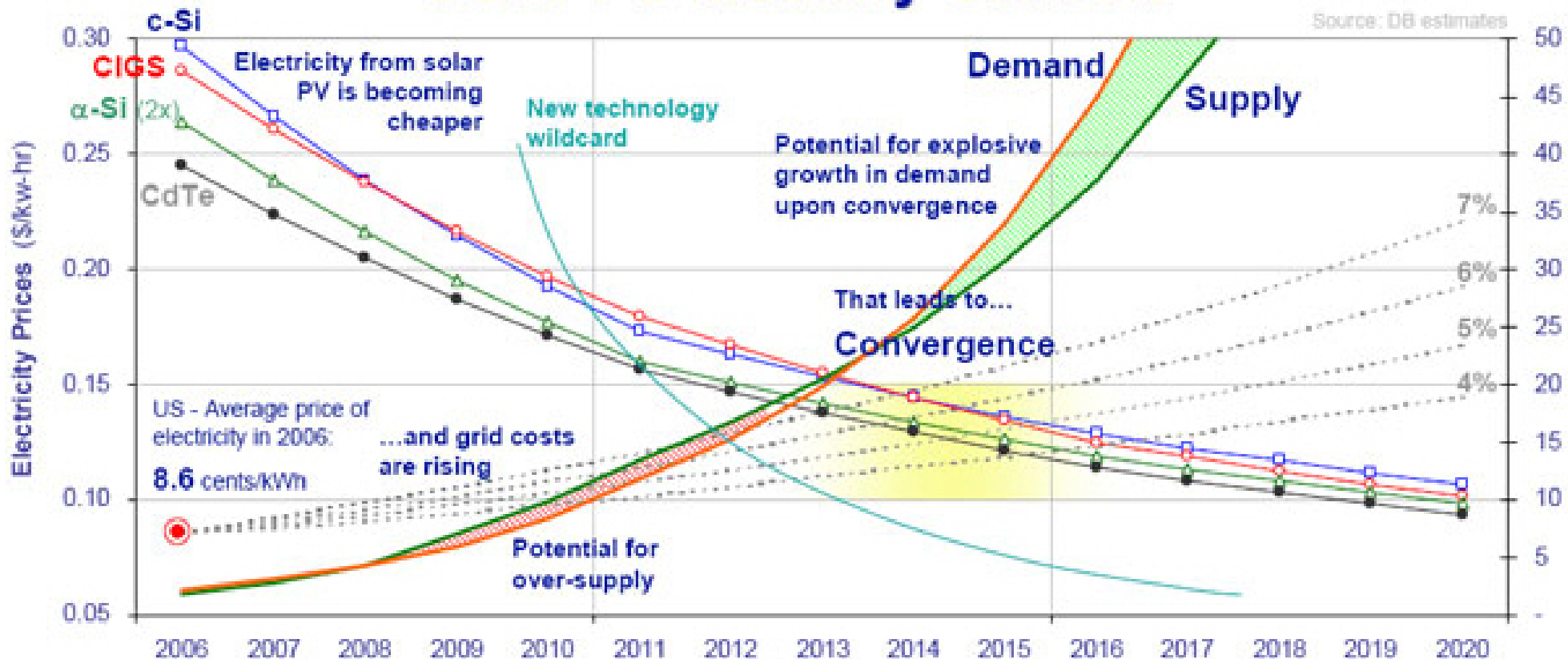

Solar basics:

How the PV cell works

Solar cells are converters.

They take the energy from sunlight and convert that energy into another form of energy, electricity.

The conversion of sunlight into electricity is made possible with the special properties of semi-conducting materials.

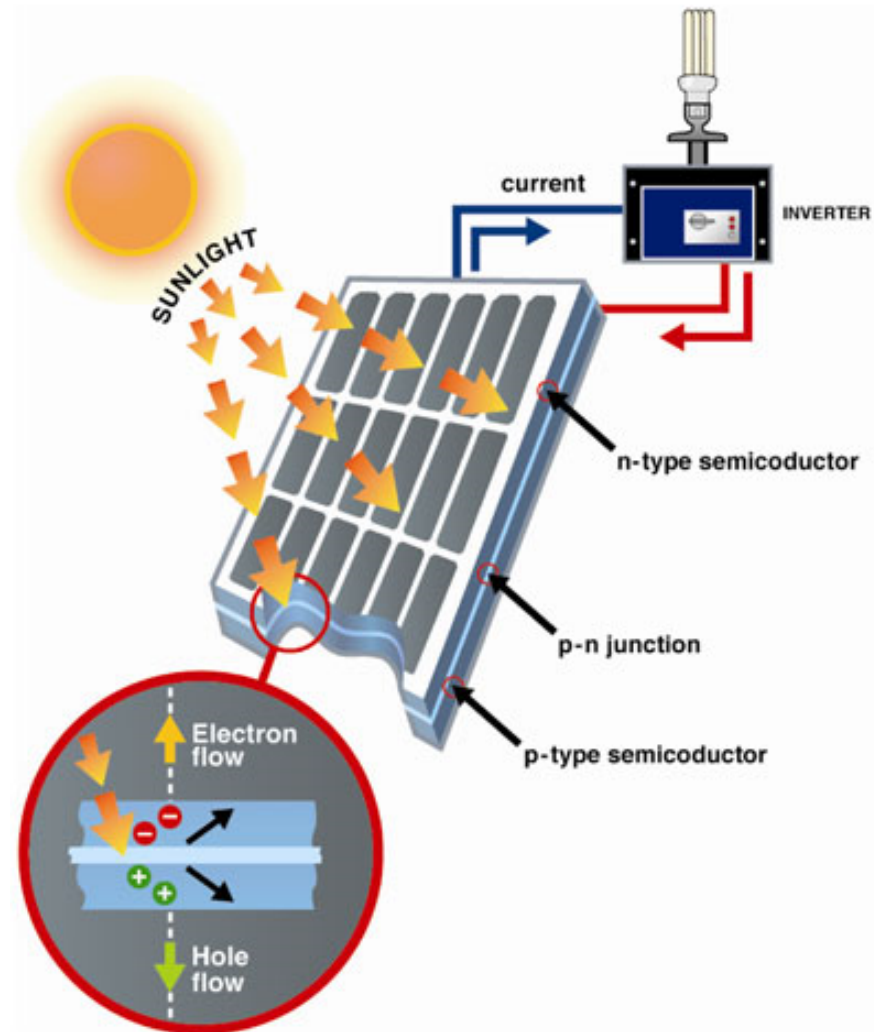

Sunlight Converted

- At the atomic level, light is made of a stream of pure energy particles, called "photons."
- This pure energy flows from the sun and shines on the solar cell. The photons actually penetrate into the silicon and randomly strike silicon atoms.
- When a photon strikes a silicon atom, it ionizes the atom, giving all its energy to an outer electron and allowing the outer electron to break free of the atom.
- The photon disappears from the universe and all its energy is now in the form of electron movement energy. It is the movement of electrons with energy that we call "electric current."



Sunlight to Electricity

A typical solar cell consists of:

- a glass cover to seal the cell,
- an anti-reflective layer to maximize incoming sunlight,
- a front and back contact or electrode, and
- the semiconductor layers where the electrons begin and complete their voyages.

The electric current stimulated by sunlight is collected on the front electrode and travels through a circuit back to the solar cell via the back electrode.



Semi-conductors:

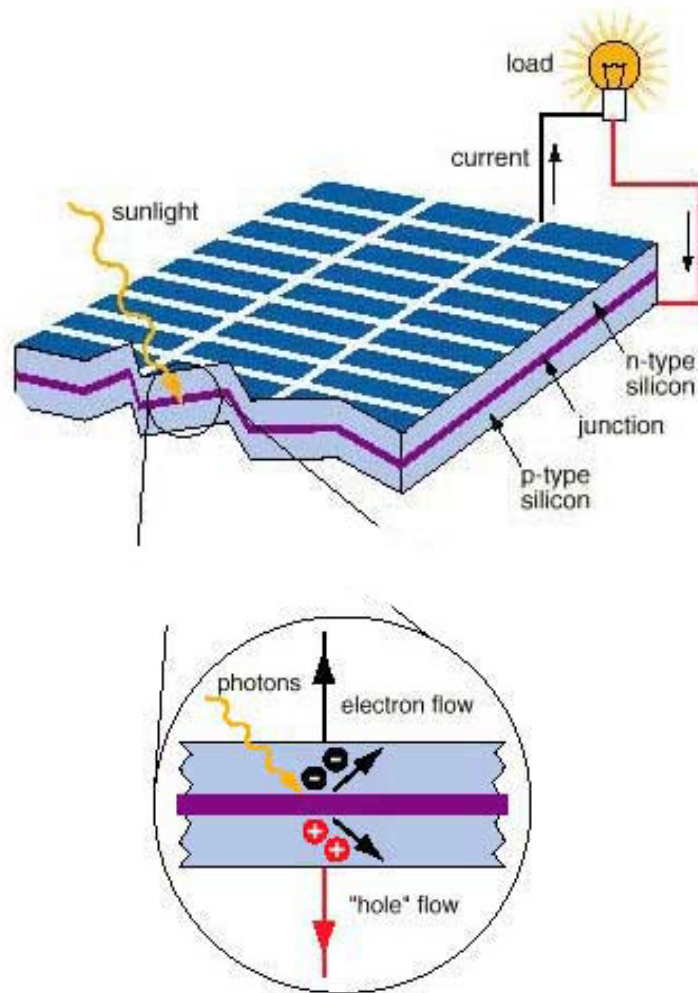

Most solar cells are made from silicon, the 14th element. Silicon is a "semi-conductor" or a "semi-metal," and has properties of both a metal and an insulator.

Atoms in a metal have loosely bound electrons that easily flow when electrical pressure is applied, whereas atoms in an insulator have tightly bound electrons that cannot flow when electric voltage is applied.

Atoms in a semi conducting material bind their electrons tighter than metals, but they may be manipulated to have conductive properties.

Semi-conductors:

Solar cells are made by joining two types of semi-conducting material: P-type and N-type.

P-type semiconductors are manufactured to contain negative ions, and N-type semiconductors to manufactured to contain positive ions.

The positive and negative ions within the semiconductor provide the environment necessary for an electrical current to move through a solar cell.

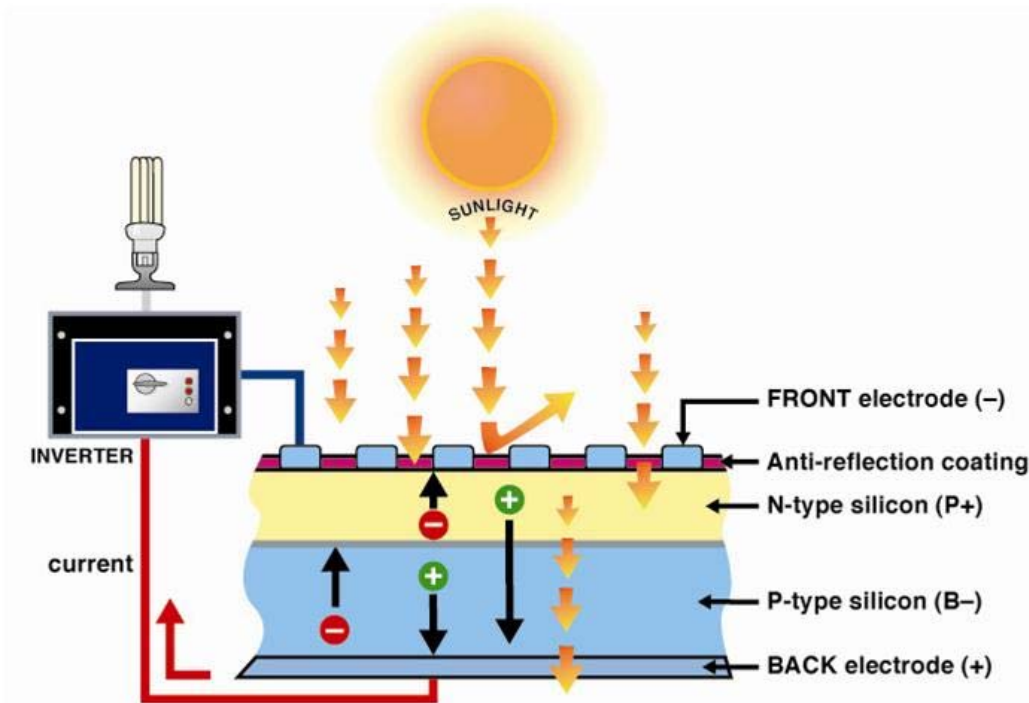

Doping:



Solar cells are created from a semi-conducting material, usually silicon, that is treated or doped with a controlled amount of impurities such as Phosphorous (N type dopant) and Boron (P type dopant) to form a PN junction.

The surface of the solar cells is coated with an anti-reflective layer to provide higher solar absorption which gives them their typical blue or black colour.



Solar cells alone cannot produce usable power. They need to be interconnected with other system components that ultimately serve a specific electrical demand, or 'load'. PV systems can either be stand-alone, or **grid-connected**.

The main difference between these two basic types of systems is that in the latter case, the PV system produces power in parallel with the electrical utility, and can feed power back into the utility grid if the onsite load does not use all of the PV system's output.

When the sun is shining, the direct current electricity (DC) from the PV modules is converted to alternating current (AC) by the power of an electronic inverter, and then fed directly into the building power distribution system where it supplies electric power.

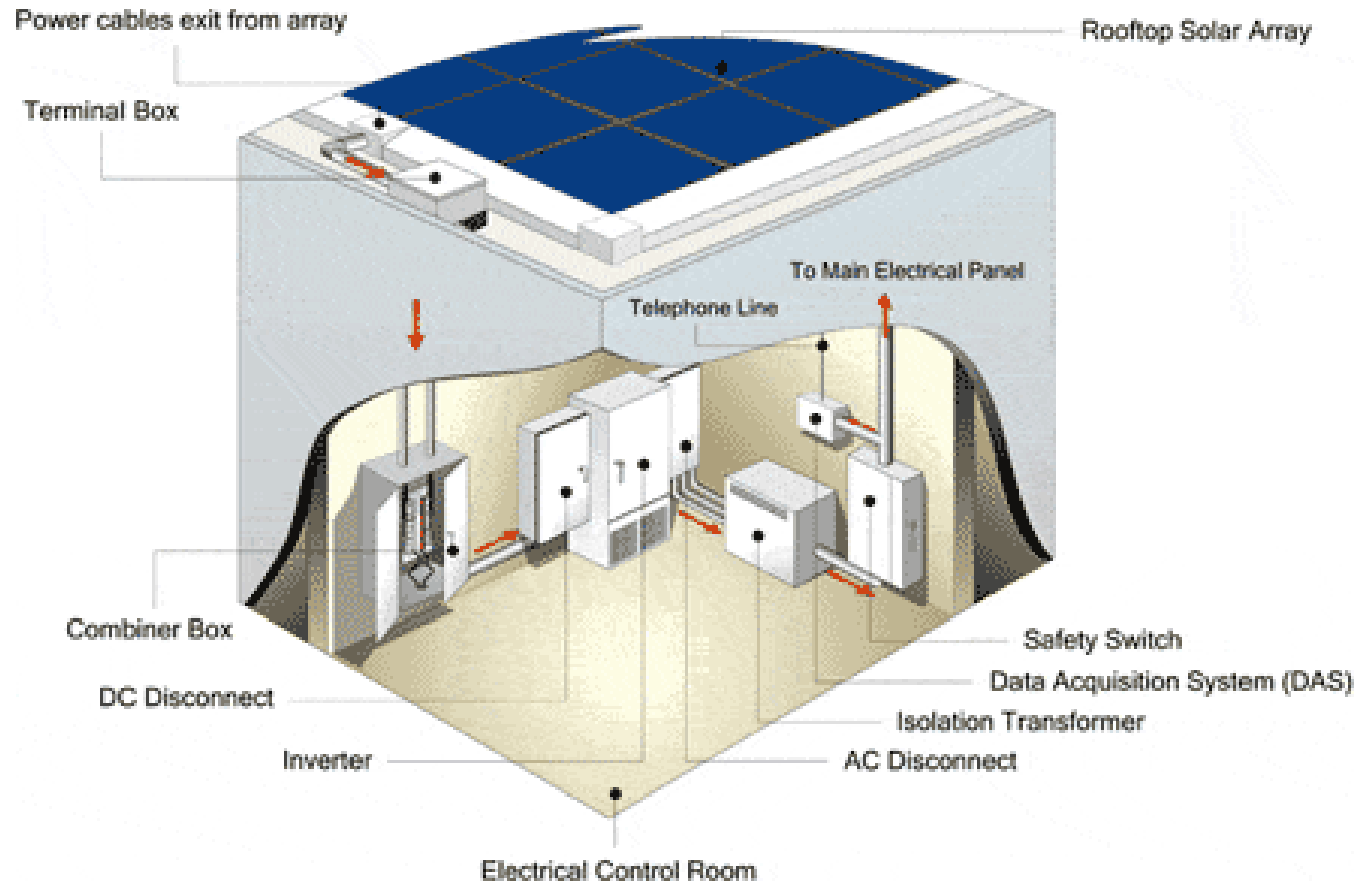

Inverters

Each of the modules must be wired and connected to the next, to eventually transfer the electrical charge to the inverter. In most cases this is done via thin, flat wires that run through the cells. In the spherical solar application, the silicon balls are embedded into a metal mesh sheet, and this acts to carry the electrical charge.



Inverters come in various sizes/types and result in some power loss via the process.

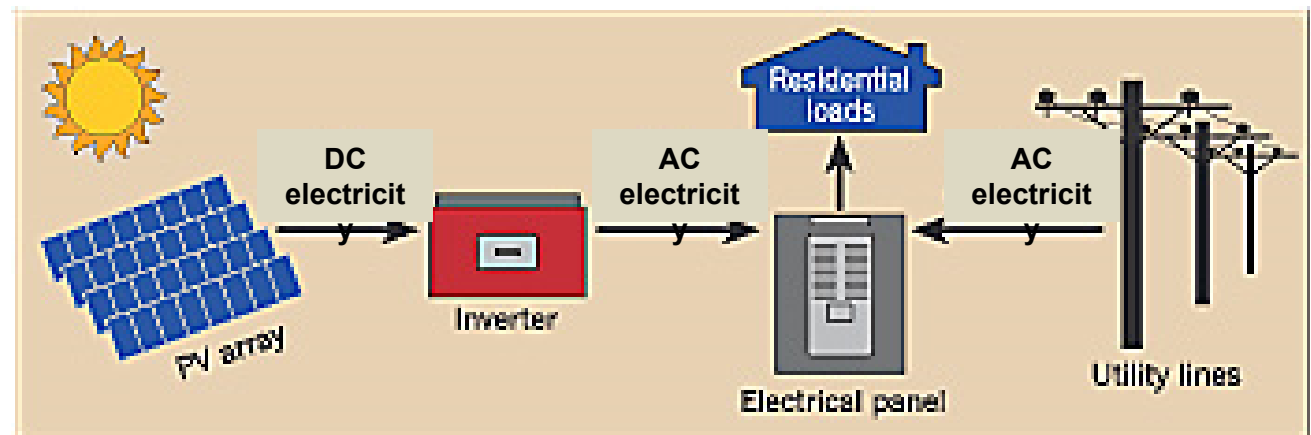

Typical residential system:



Need to include a place for and access to the panels.

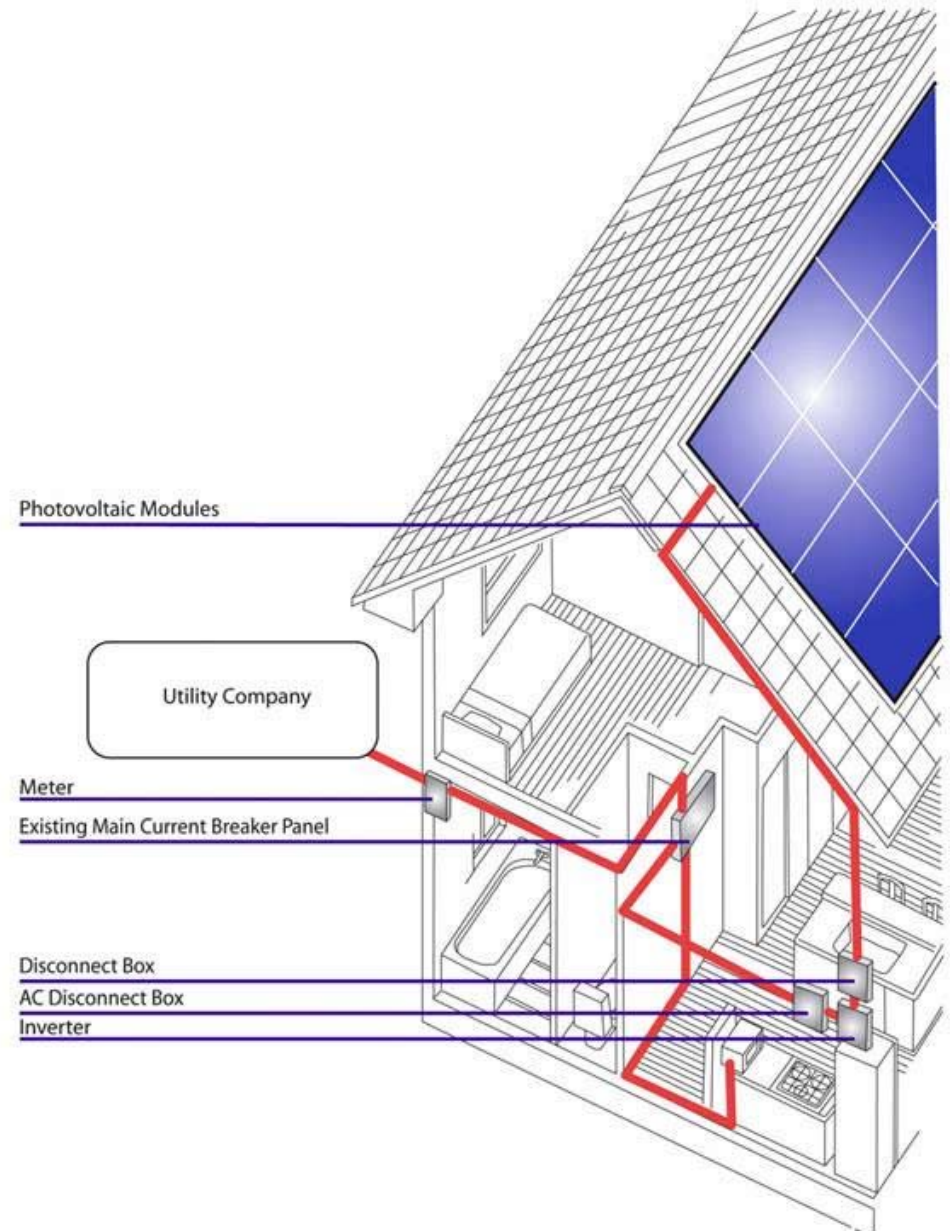

Types of silicon cells:

An individual solar cell can vary in size from 1cm to 15cm and produce between 1 and 2 watts.

Main types on the market are crystalline and thin film. New addition being the “spherical solar” variety. These use tiny balls of silicon embedded into a metal sheet, rather than crystal type silicon.

Cells are combined into **modules**, and **modules** into **arrays**. Arrays are ganged on a surface to provide the amount of power required.



Crystalline silicon:

Mono crystalline cells: are made from very pure mono-crystalline silicon. This type of silicon has a single and continuous crystal lattice structure with almost no defects.

High efficiency (15%).

Energy intensive manufacturing process.

Expensive.

Mono-crystalline cells tend to be flat black or deep blue in color.

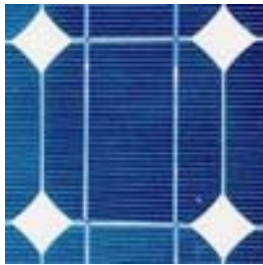

mono



mono

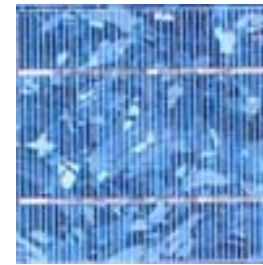

poly

Crystalline silicon:

Poly- or multi-crystalline cells: are produced using numerous grains of mono-crystalline silicon and have a more irregular surface. In the manufacturing process the silicon is cast into ingots which are rectangular/square in shape. These are cut into very thin wafers and assembled into complete cells. They can also grow this on a substrate.

Less efficient (12%).

Less expensive.

Polycrystalline cells have a mottled (like galvanized steel), cobalt blue appearance.

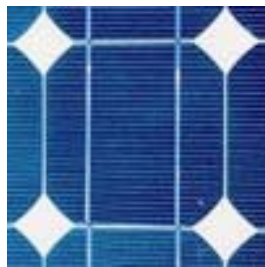

mono



mono

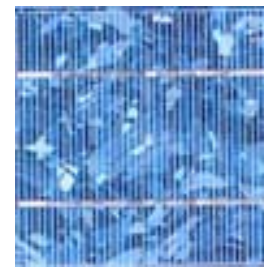

poly

Photovoltaic modules of varying sizes.

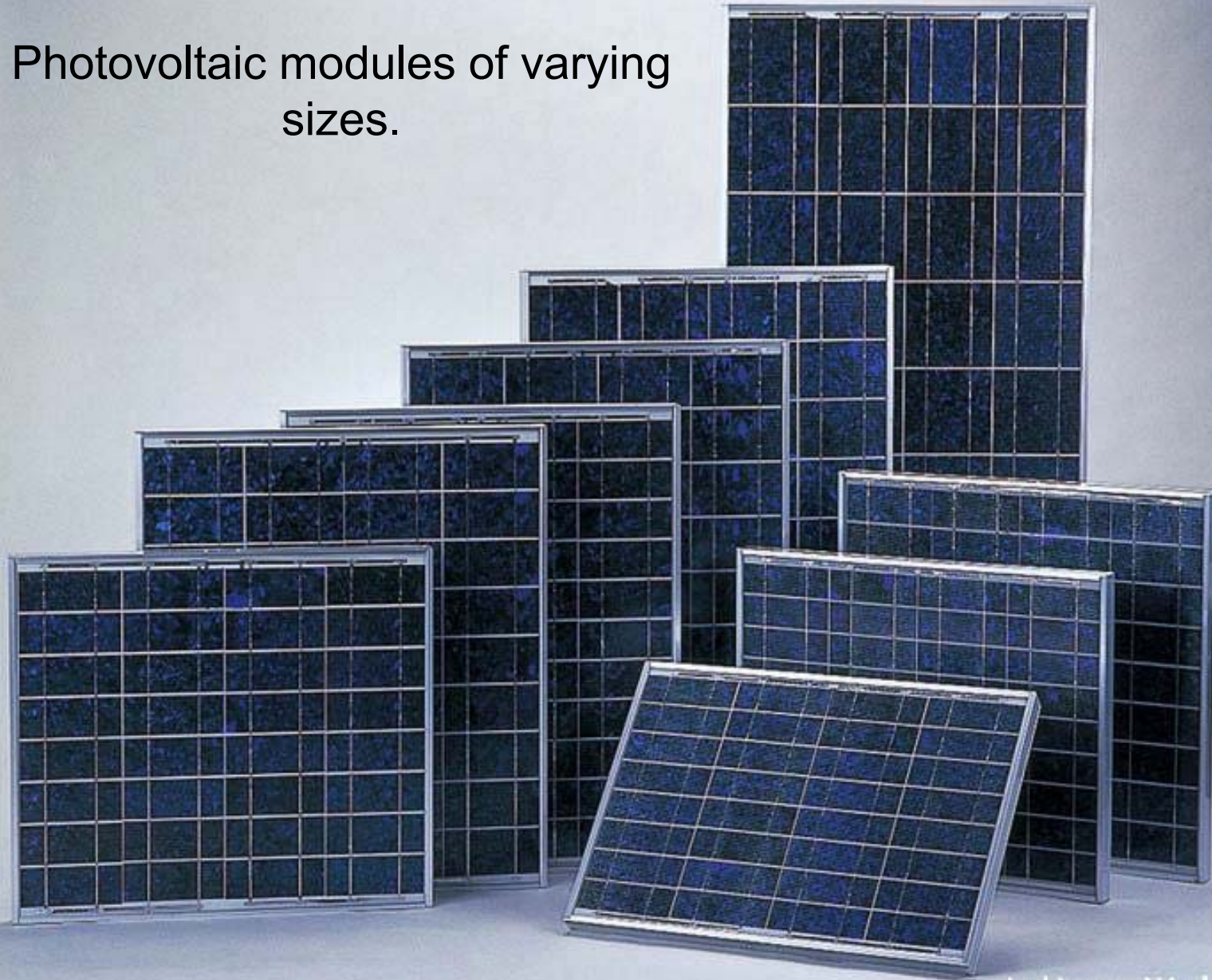



Thin film silicon:



Thin film cells can be amorphous silicon, copper-indium-diselenide (CIS) and cadmium-telluride (CdTe) cells.

Composed of silicon atoms arranged in a thin amorphous matrix rather than a crystalline structure. Amorphous silicon absorbs light more effectively than crystalline and the product is much thinner. Cheaper to produce, but with efficiencies around 6%. These modules have a charcoal grey or bronze color and look like low-E coating or fretting when used on vision glass. Other colors are available but, the cost will be higher.

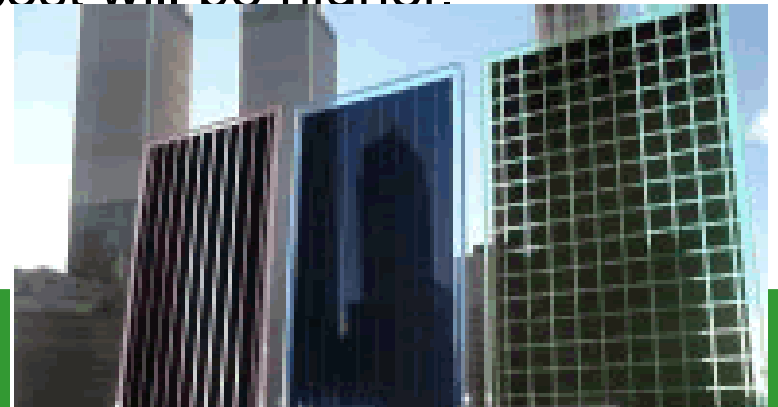

Comparison of efficiencies:



Cell type	Typical output
Mono-crystalline \$\$\$	12-15%
Poly-crystalline \$\$	11-14%
Amorphous silicon \$	6-8%
Cadmium telluride \$	7-10%
CIS Copper indium diselenide \$	8-12%

Important to track expense vs. efficiency...

Environmental issues:

	Crystalline silicon	Amorphous silicon	Cadmium telluride	Copper indium diselenide
manufacture	Oil-based slurry in slicing silicon wafers	No adverse environmental effects	Cadmium is a known carcinogen	Little known about health effects
	Carbon tetrafluoride (a potent GHG) used for edge trimming; Lead (heavy metal) used to solder cell electrical connections	Very little semiconductor material used	Deposition method is greatest variable: electrodeposition: 90% efficient; spraying: 5% efficient	
End of life	Cells have been salvaged and reused in new modules	No adverse environmental effects	High rates of recovery for all semiconductor materials	

There are environmental costs associated with both the manufacturing and disposal of PV when it has outlived its usefulness.

Spherical solar technologies:



Conventional Solar Panel

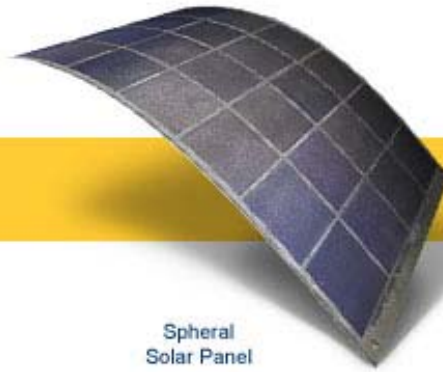

Spherical Solar Panel

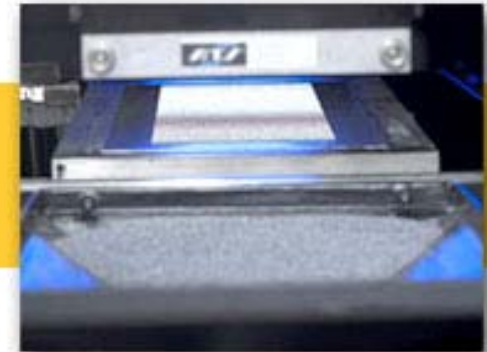
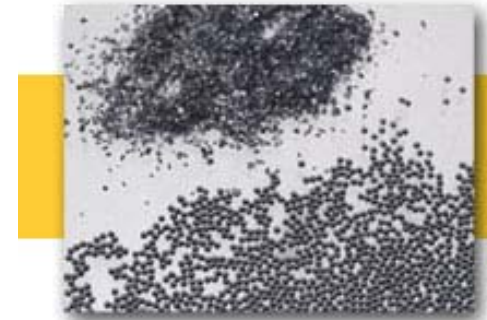
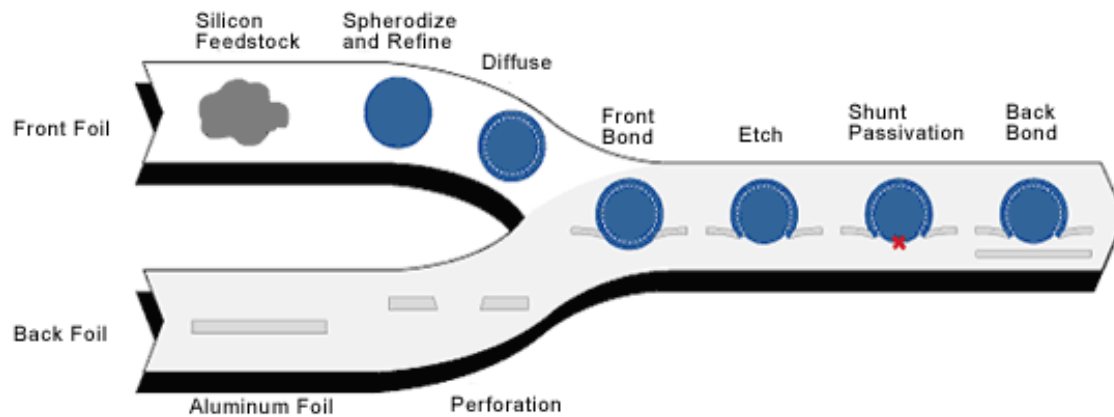

The metal backing material carries the charge.

Temperature:

Photovoltaics produce heat as a by-product of the process by which sunlight is changed to electricity. They must be installed so that they are vented, as overheating will decrease their efficiency.

Photovoltaics actually work better in cold weather situations. This makes Canada a good climate for their use.

Temperature:

Contrary to most peoples' intuition, photovoltaics actually generate more power at lower temperatures with other factors being equal.

This is because photovoltaics are electronic devices and generate electricity from light, not heat. Like most electronic devices, photovoltaics operate more efficiently at cooler temperature.

In temperate climates, photovoltaics will generate less energy in the winter than in the summer, but this is due to the shorter days, lower sun angles and greater cloud cover, not the cooler temperatures.

Rain and snow

Roof mounted PV arrays can be covered with snow in the winter. If the array is covered, it will not work.

In snowy climates, **sloped arrays are preferred** to flat installations as theoretically the sun will penetrate the snow, heat the dark PV layer, melt the base of the snow and it will slide off of the panel. It is important to prevent such snow from piling up at the base of the array, or sliding uncontrolled onto passers by below the installation.

Sometimes it is necessary to shovel the array. Care must be taken not to damage it.



Rain will not adversely affect a PV array system since during periods of rainfall the solar irradiance is already low.



Snow must either naturally slide off or be cleaned off.

Dirt and pollution:

Any factor that reduces light transmittance to the PV surface will reduce the output of the system.

If dirt is allowed to accumulate (more likely in urban areas), the output can be reduced by 2% to 6+%.

The higher value occurs if the slope of the array is less than 30 degrees.



This PV array in Abu Dhabi at Masdar City is covered in dust – a huge problem in a country with sand/dust, humidity and no fresh water!

Dirt and pollution:

The occasional heavy rainstorm is usually sufficient to clean the array.

If PV is installed on a wall surface, rain can keep it clean if the array is exposed to such. Otherwise, the surface can be cleaned in the same way as window systems would be.



Dirt and pollution:



Much research is going into nano technology to create self cleaning PV.

Shading:

AVOID SHADING THE PANEL. The shaded area will not reduce the output proportionally to the area shaded -- loss is much higher. Within a chain of modules the output will be that of the weakest (shaded) module. If shade cannot be avoided at certain times, be sure to gang the affected modules together on the same circuit, leaving the sunny modules to fully function.



This education building at IslandWood near Seattle, Washington is designed to prevent shadows from the nearby trees from shading its PV.

Shading:

Effects of shading different portions of the array.

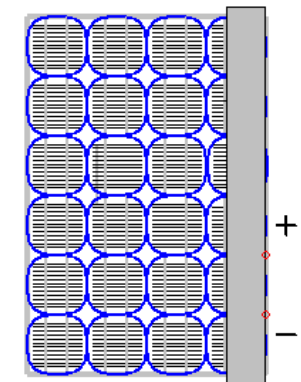
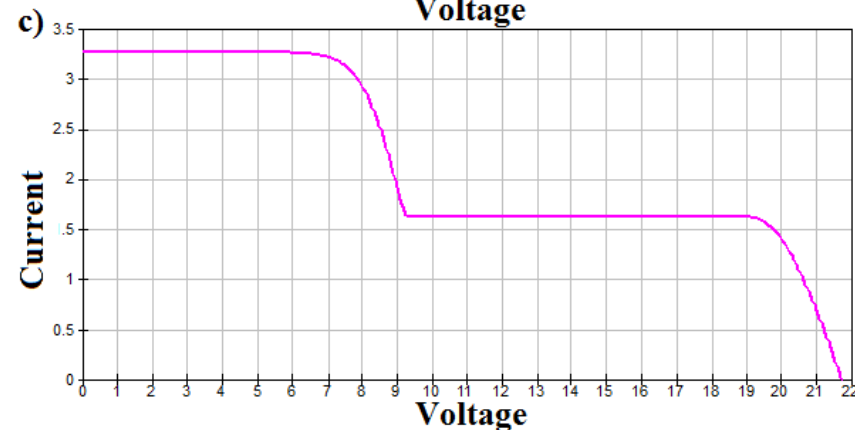
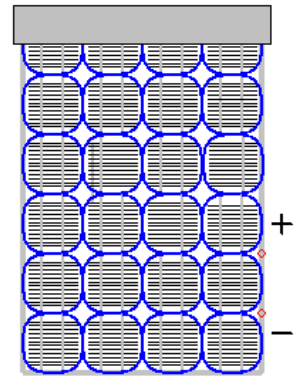
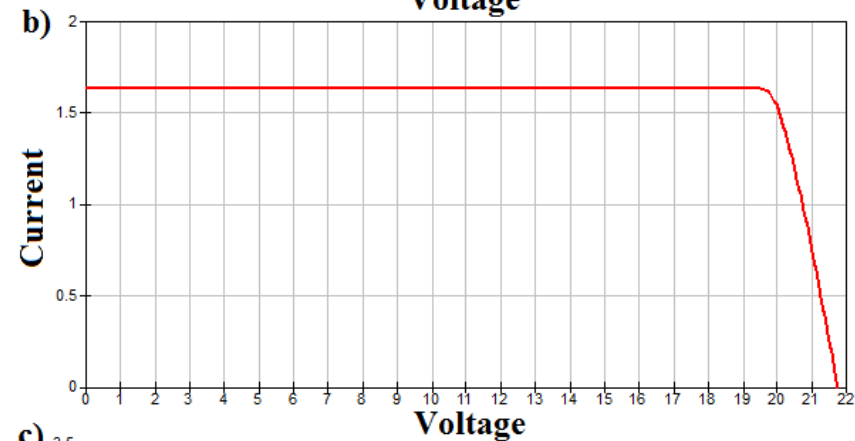
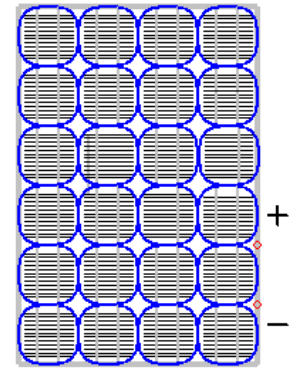
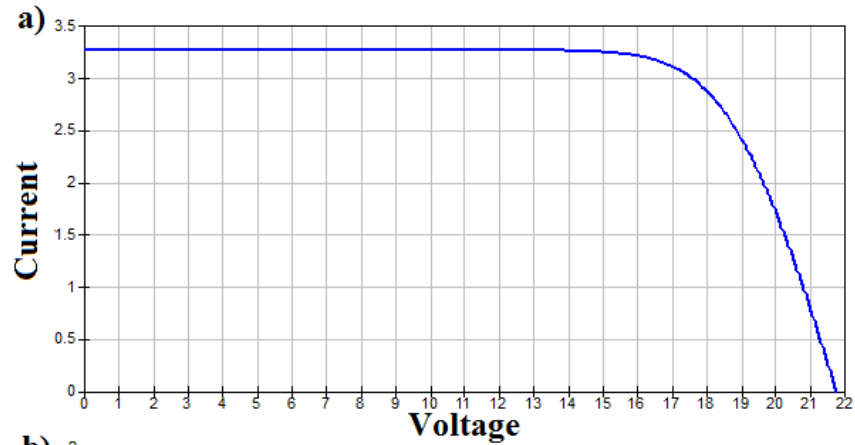

Shading:



It is essential to provide unobstructed access to sunlight to optimize efficiency.

Use Sky Dome to prevent Shading:

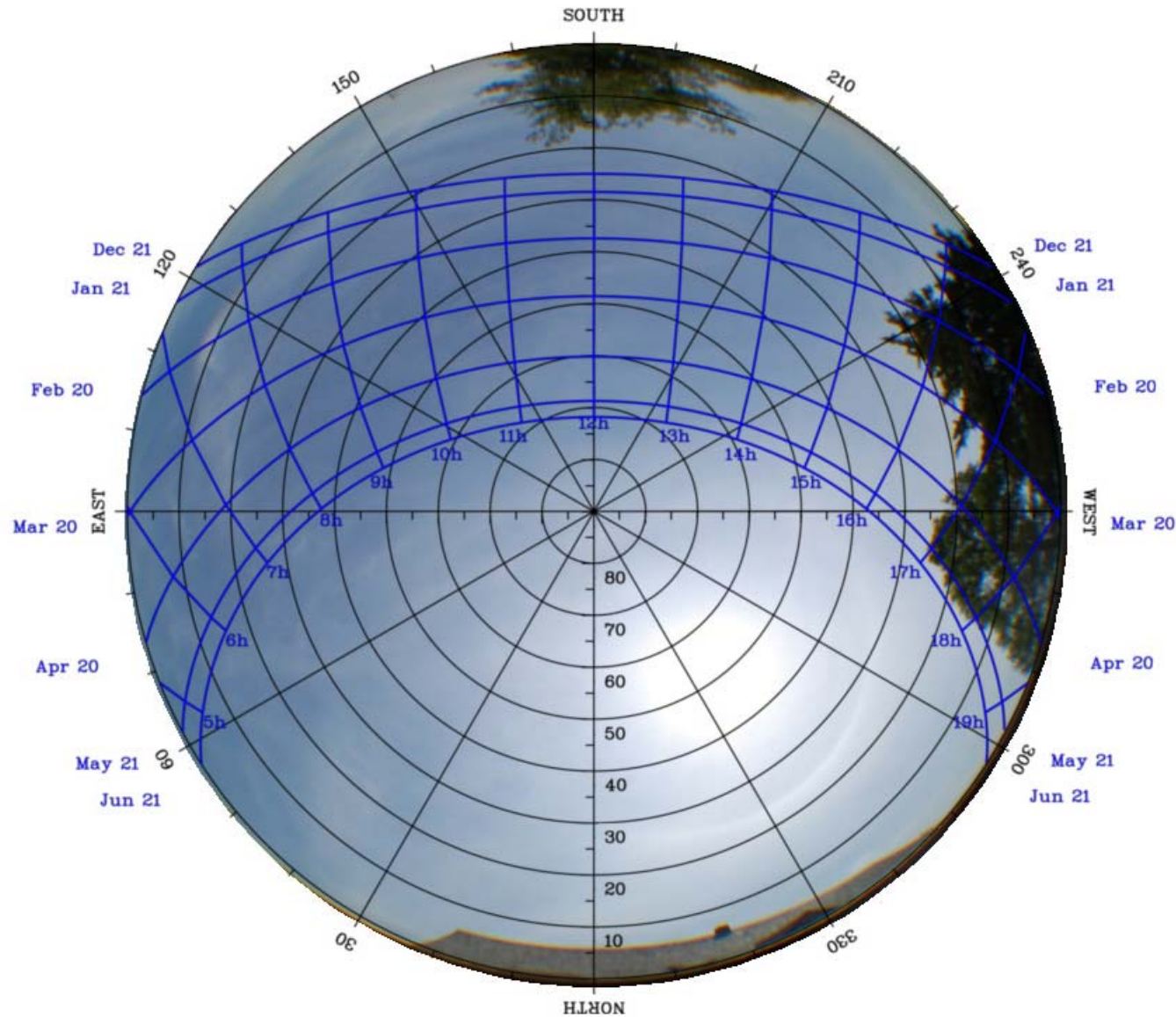

Orientation:

Due south is ideal but deviations up to 45 degrees only result in a 10% loss of power.

As a rule, BIPV installations are best when oriented south and tilted at an angle of 15 degrees higher than the site latitude; ie.

The further north you go, the more vertical the panel as the sun angles are low in the sky and the system performs better when the rays strike at a right angle (less reflectance).



The Aldo Leopold Center is able to be designed to maximize its orientation efficiency for its PV due to its rural site.

Variation of solar irradiance (%):

tilt	west	75	60	45	30	15	south	15	30	45	60	75	east
10°	83	85	86	87	88	89	90	89	88	87	86	85	83
20°	82	84	87	88	91	92	93	92	91	88	87	84	82
30°	79	83	87	91	95	96	96	96	95	91	87	83	79
40°	73	81	86	90	92	98	100	98	92	90	86	81	73
50°		78	83	87	91	95	96	95	91	87	83	78	
60°			80	82	84	90	91	90	84	82	80		
70°				78	81	84	85	84	81	78			
80°						75	77	75					
90°							72						

Variation of solar irradiance with orientation and tilt for 52° N
 **this must be measured for the precise latitude in question.

PV versus BIPV??

BIPV stands for “**building integrated photovoltaic**” systems.

These use PV, except attempt for a more “architectural integration” of the PV into the roof, wall, glazing and shading systems.

Integration aims to reverse the trend to think of PV as an “add-on” (and usually pretty ugly) system, and ensure that it works as part of the building envelope system.

This works with sustainable notions of having building elements “do” more than one thing. Roofs can easily accommodate another use -- by adding electrical production. The same with curtain walls, skylights, etc.



This is NOT Building INTEGRATED Photovoltaics!



This is not totally, but better, integrated.

This roofing IS being integrated into the flat roof system:



BIPV: wall systems





The PV on the Calgary Child Centre is used simultaneously as shading devices for the windows.

Glazing systems:

Vertical glazing applications



When thin films are incorporated into curtain wall glazing, they can act as a shading device as well.



Integrated sloped roofs:

Sloped roofs



Balcony railings:

Balcony -- walls



Skylights:

When using thin film in the glazed panels of skylights, the growing practice is to use pitched skylights, have daylight enter from the north side and use the south facing slope for PV.



Skylights:



This also cuts down on excess heat gain into the space, while allowing some south light to enter.



Skylights:



National Works Building, Vancouver, LEED Gold

PV roof shingles:



Thin crystalline products have been made into shingles that are run in series and can be installed in lieu of standard shingles.



PV Flat roof systems:

PV modules are currently being manufactured as the “top layer” of roofing membranes. The membranes are installed as “normal” (adhered, mechanically fastened, etc.). These applications are more common in snow free climates where snow build-up will not eliminate solar rays for many months of the year.

standard

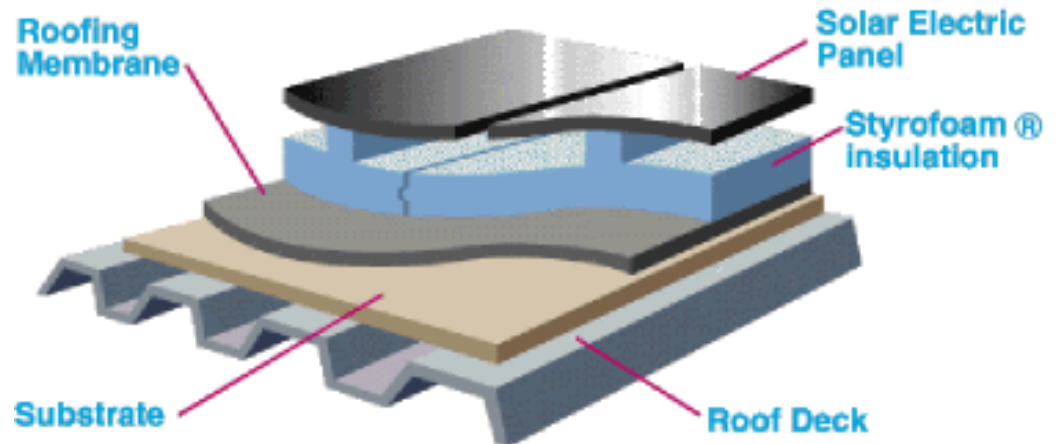

integrated

Leading the way in the manufacture and installation of photovoltaic power systems for commercial and industrial applications.

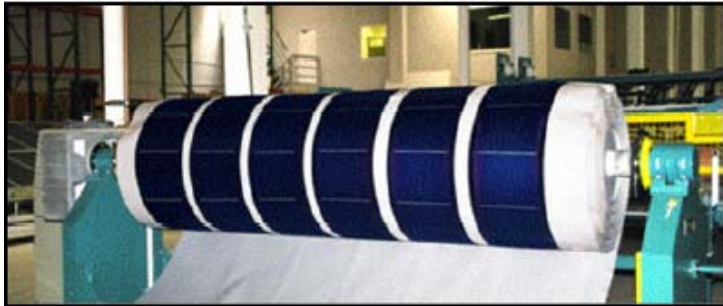

www.solarintegrated.com





BedZED, Hackbridge – near London, UK



Thin PV integrated into the glazing at BedZED



Thin PV integrated into the glazing at BedZED



Thin PV integrated into the glazing at Lillis School of Business, U of Oregon



Thin PV integrated into the glazing at Lillis School of Business, U of Oregon



Thin PV integrated into the glazing at Lillis School of Business, U of Oregon



Thin PV integrated into the glazing at Lillis School of Business, U of Oregon



Thin PV integrated into the glazing at Lillis School of Business, U of Oregon

North House – Ontario/BC



The following 2009 Solar Decathlon houses showcase PV. Ours integrated it into the vertical faces of the south, east and west elevations. Our solar hot water array was on the roof – so relegated as it was not as good looking.

Germany



This pavilion took first place in the Solar Decathlon largely due to its PV array and production of electricity.



The PV is attached as shingles. For visual interest, other materials are attached in the same way for a pattern.

Cornell



The PV is firmly mounted on the roof but could be set to track the sun. The wall installation is evacuated tubes for solar hot water.

Illinois



PV covers the entire south face of the roof to maximize potential and also to create a more integrated “look” to the installation.

Louisiana



PV is roof mounted and faces the rear of the house. PV does not work well if it overheats so space is left around it for ventilation.

Spain



PV is integrated into the vertical face of the building. The PV on the roof rotates to track the sun.

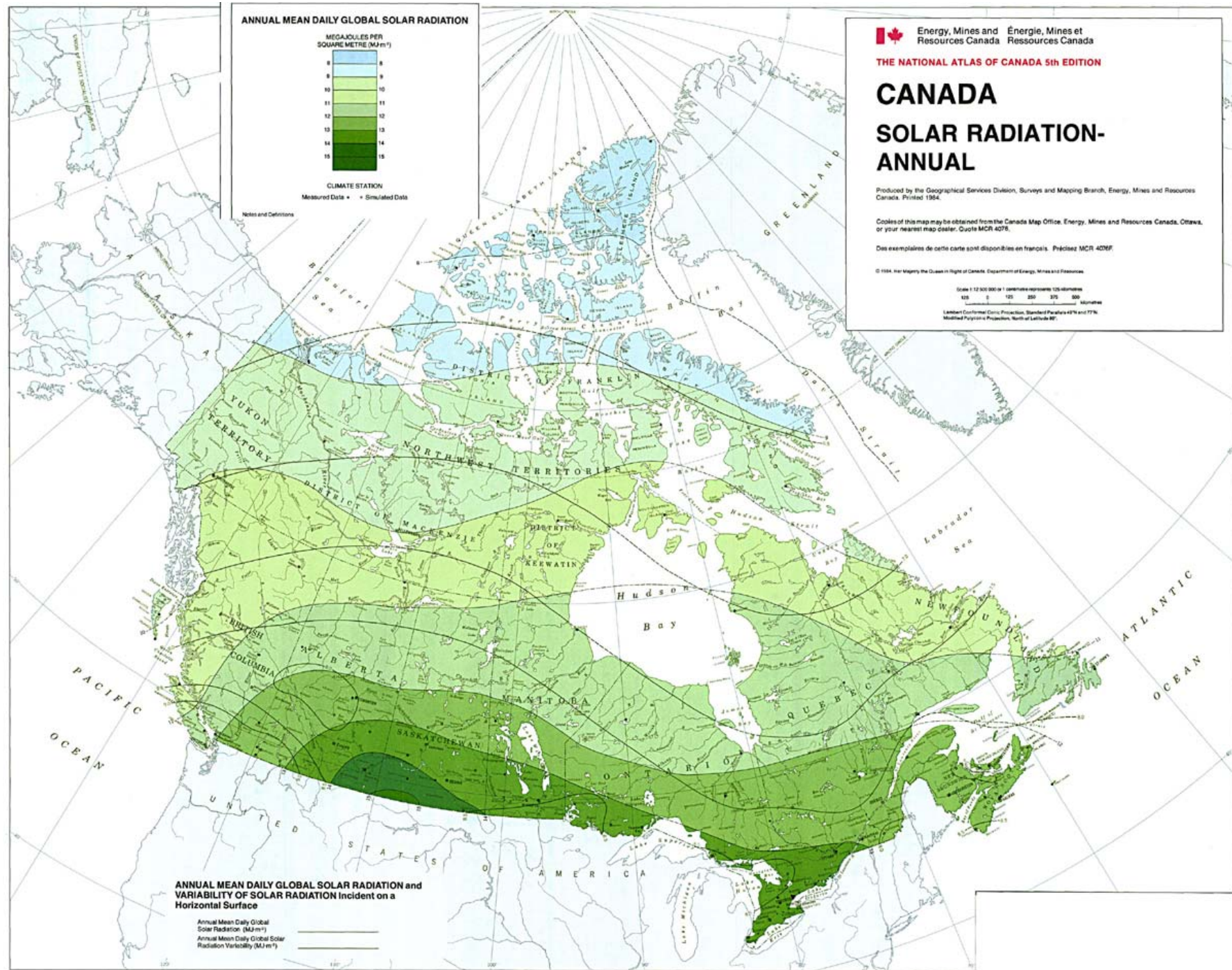

Site suitability: annual solar radiation on a horizontal surface

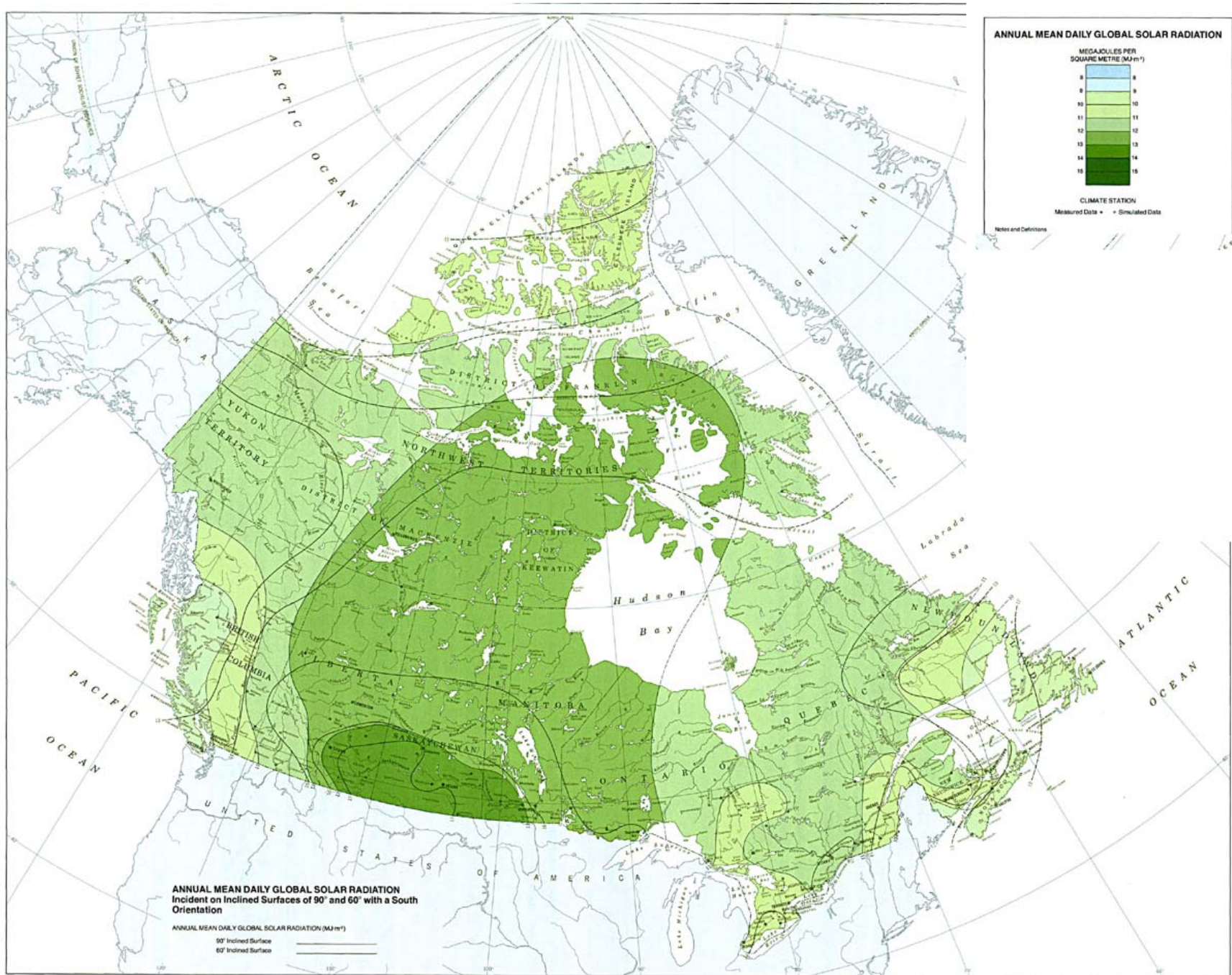

- Site suitability: annual solar radiation on an inclined surface

Site suitability: US

Site suitability is a function of the total number of sunlight hours available over the year. At present this is more a function of economics due to the high cost of pv versus its current efficiency.

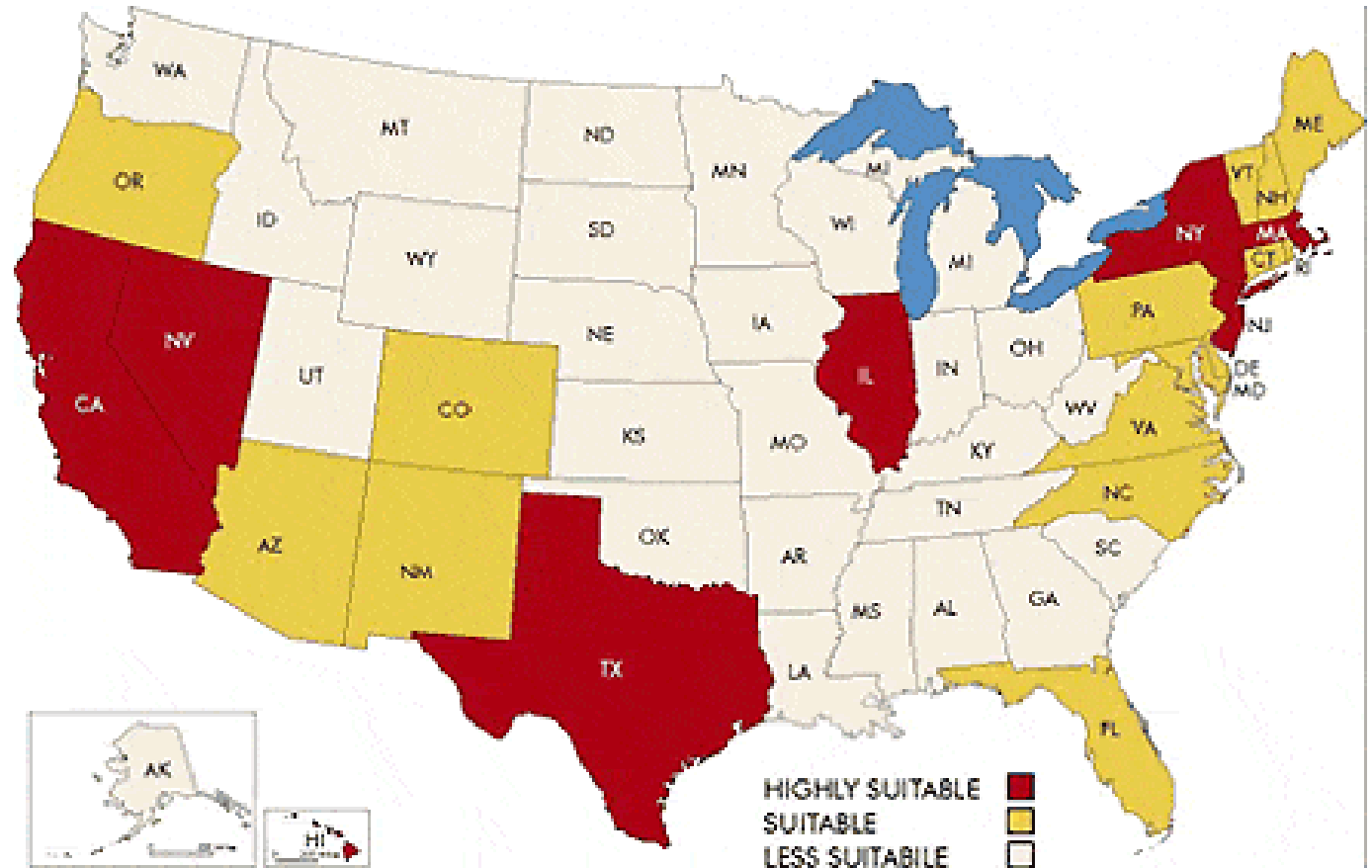

World comparison of annual sunshine hours:

This chart compares the annual number of hours of sunshine received for various cities around the world. Canadian cities (red box) are generally better than cities like Berlin and London where “greener” high tech buildings are more often found.

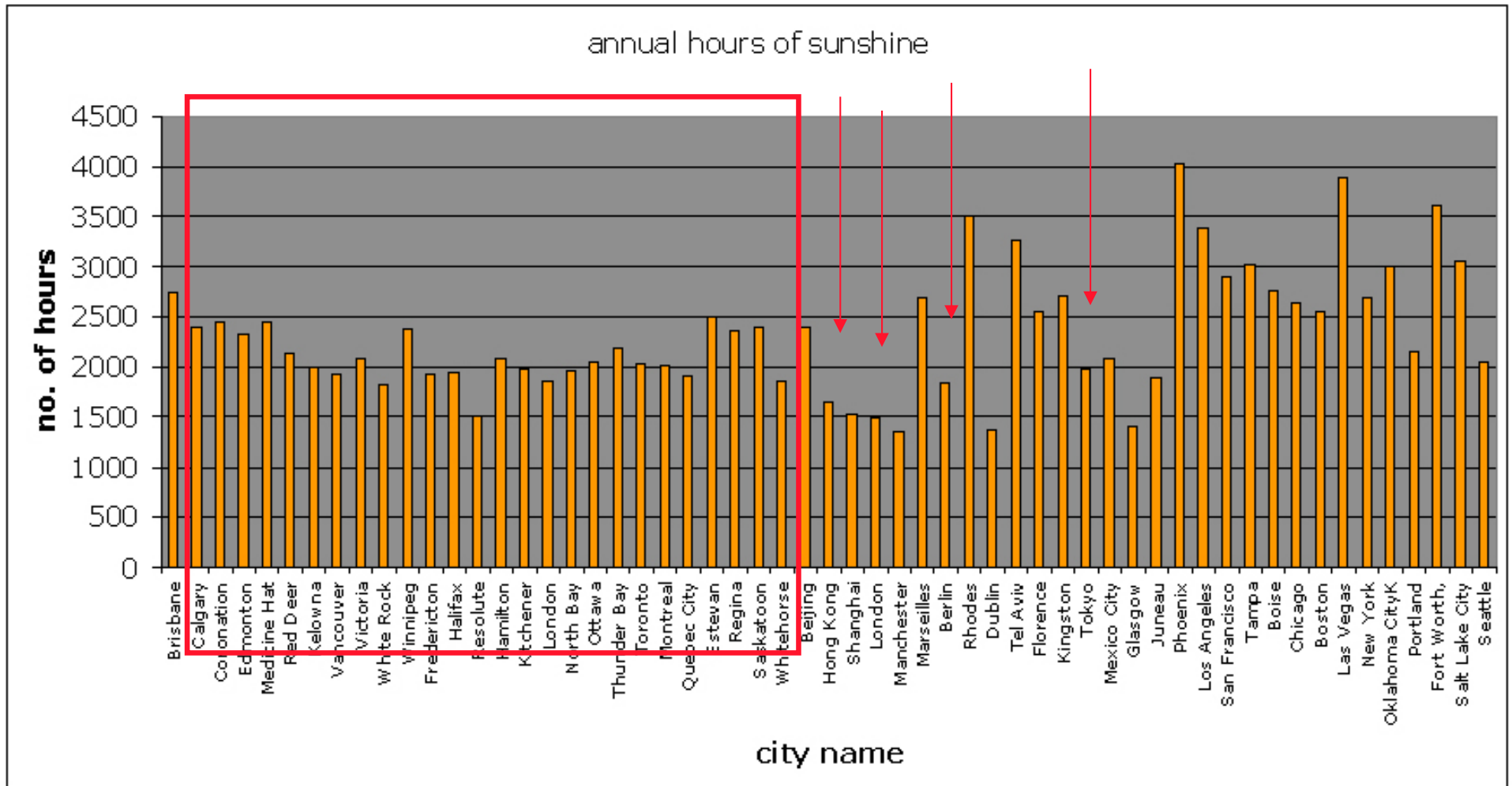

How much PV do I need for my house?

- Check electrical bills to find out your normal use amount
- Determine the space available for PV
- are you using roof or walls?
- You need about 100 sq. ft. of space for each kilowatt of power you want to produce. If needed, the system can be split to accommodate obstacles on your roof. Thin film modules take about 175 sq. ft. per kilowatt.
- Verify output of type of PV chosen
- verify amount of sunlight and light conditions for your area

- most houses will NOT install adequate PV for complete standalone, off grid system
- usually need batteries to store for later retrieval

Net metering:

Effective use of PV and wind really requires the public utilities to support net metering. In this case, the utility has to purchase excess power created, and in turn, supplies power when not enough is produced. This saves the need for battery storage for low periods.

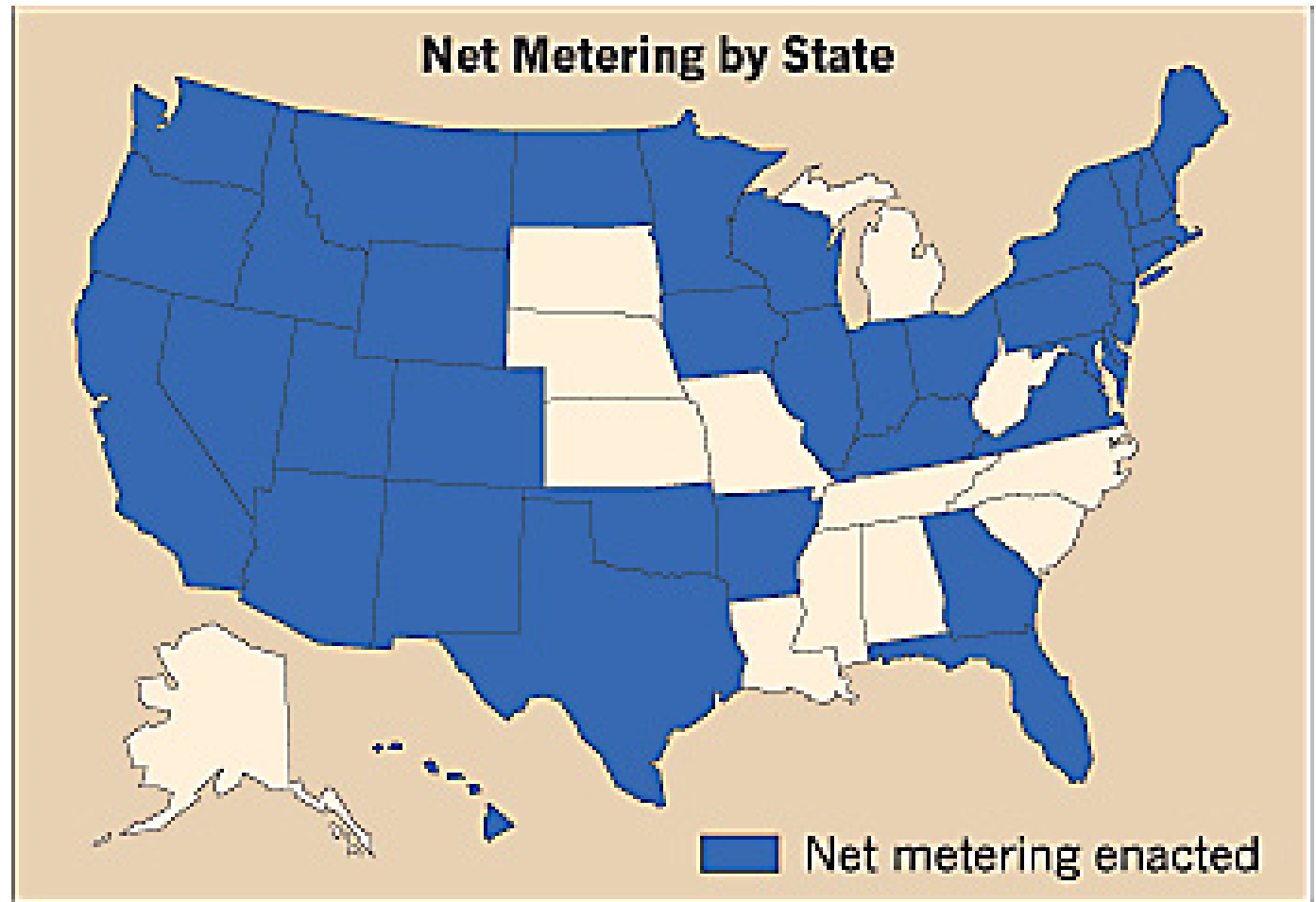

Net metering is not widely available yet in Canada. It has to be negotiated contract by contract....

Net Metering

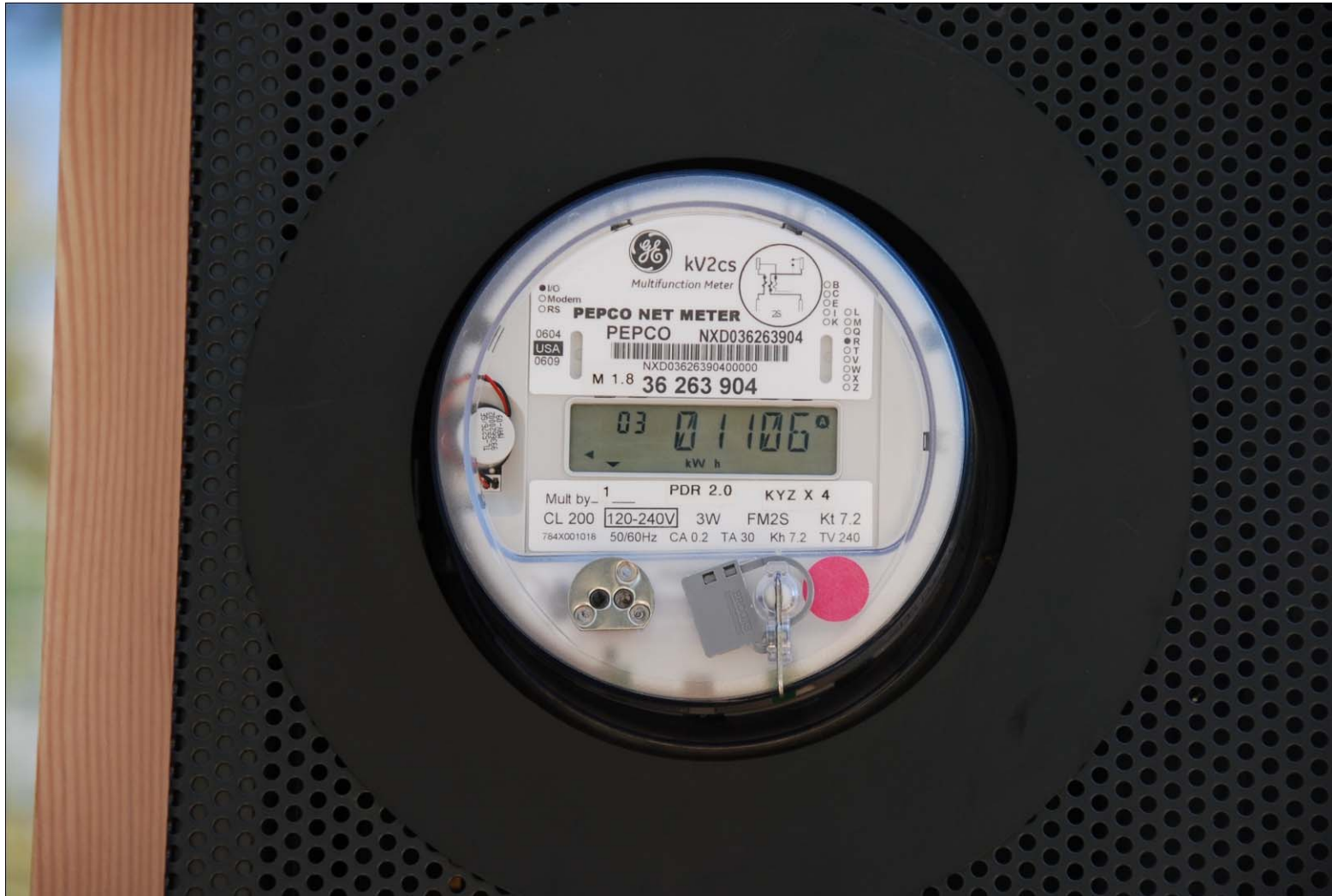

This is the net meter for North House. It can spin both directions, depending how much you are either giving to the grid or taking from the grid

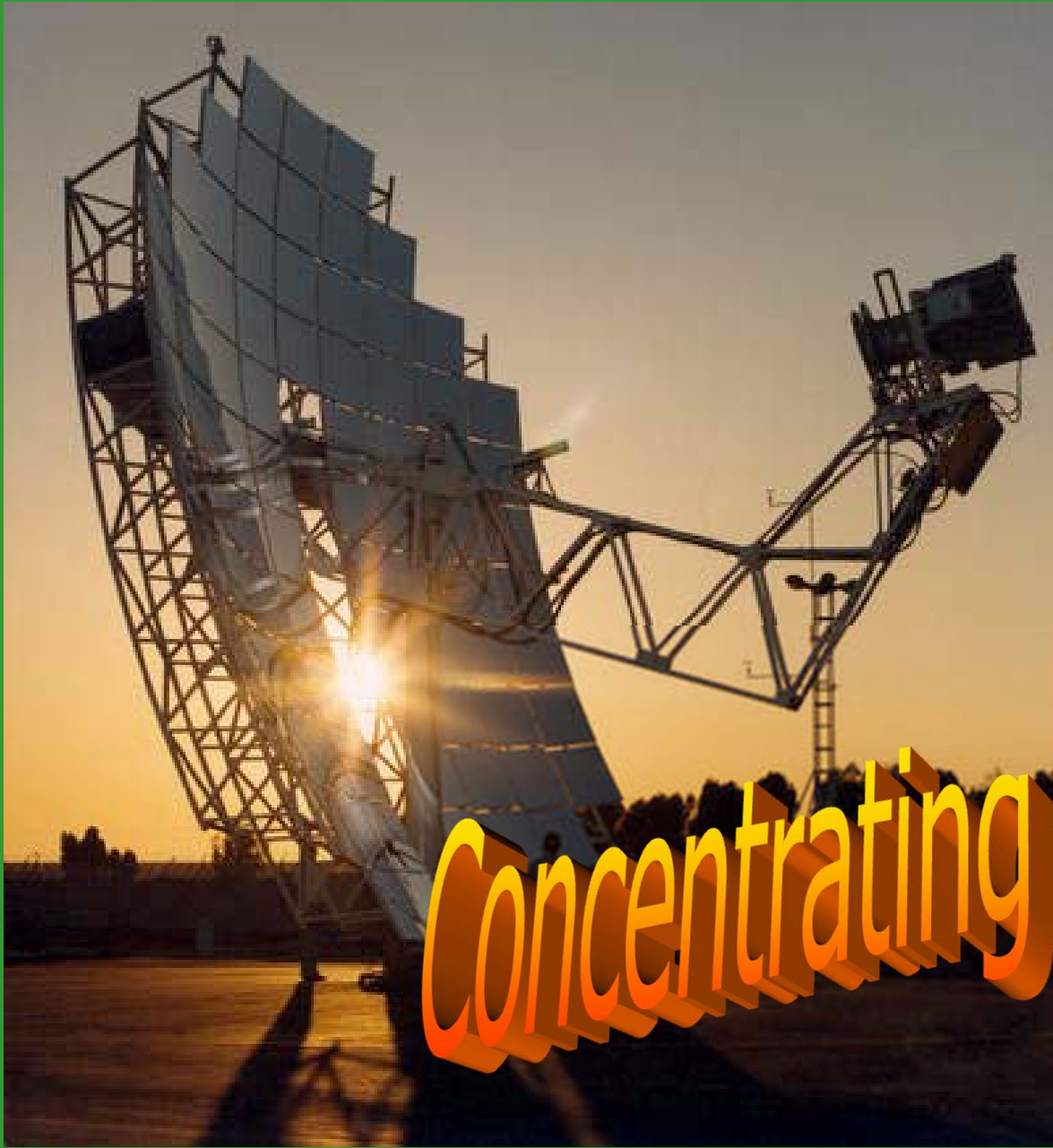

Concentrating Solar Power

Concentrating Solar Power:

Most techniques for generating electricity from heat need high temperatures to achieve reasonable efficiencies. The output temperatures of non-concentrating solar collectors are limited to temperatures below 200° C. Therefore, concentrating systems must be used to produce higher temperatures. Due to their high costs, lenses and burning glasses are not usually used for large-scale power plants, and more cost-effective alternatives are used, including reflecting concentrators.

The reflector, which concentrates the sunlight to a focal line or focal point, has a parabolic shape; such a reflector must always be tracked. In general terms, a distinction can be made between one-axis and two-axis tracking: one-axis tracking systems concentrate the sunlight onto an absorber tube in the focal line, while two-axis tracking systems do so onto a relatively small absorber surface near the focal point.

CSP Types:

Concentration of sunlight using:

- (a) parabolic trough collector
- (b) linear Fresnel collector
- (c) central receiver system with dish collector and
- (d) central receiver system with distributed reflectors

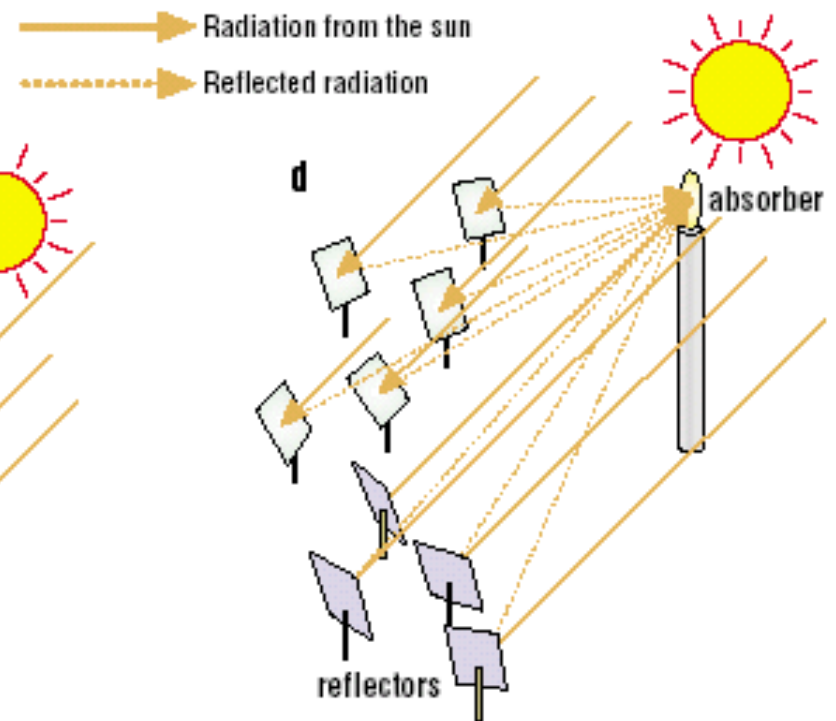
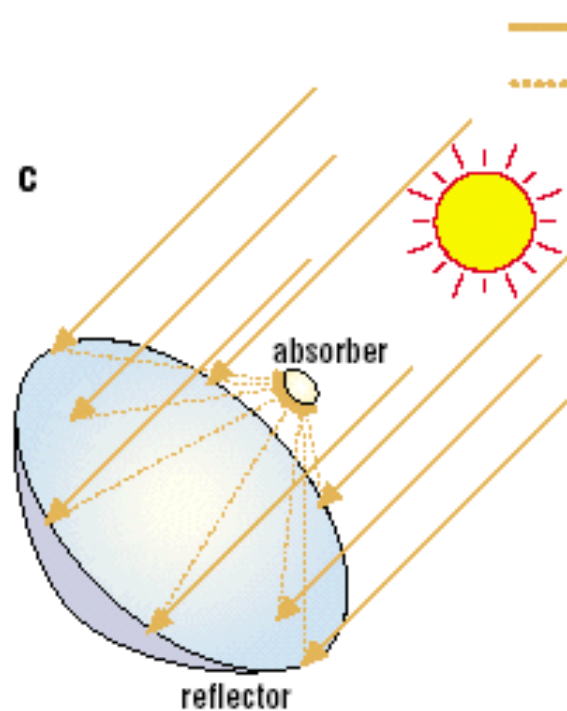
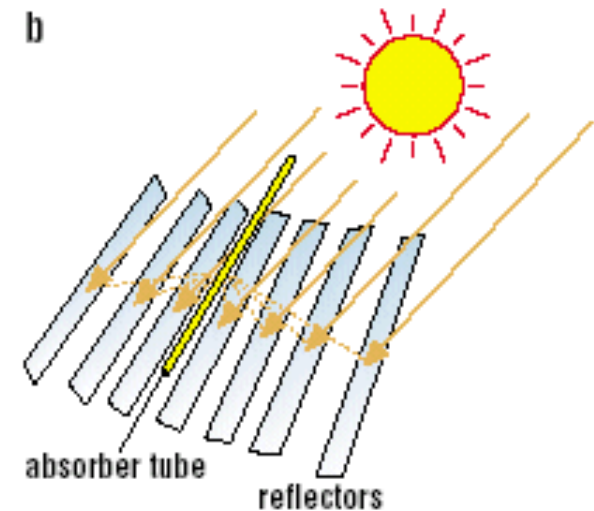
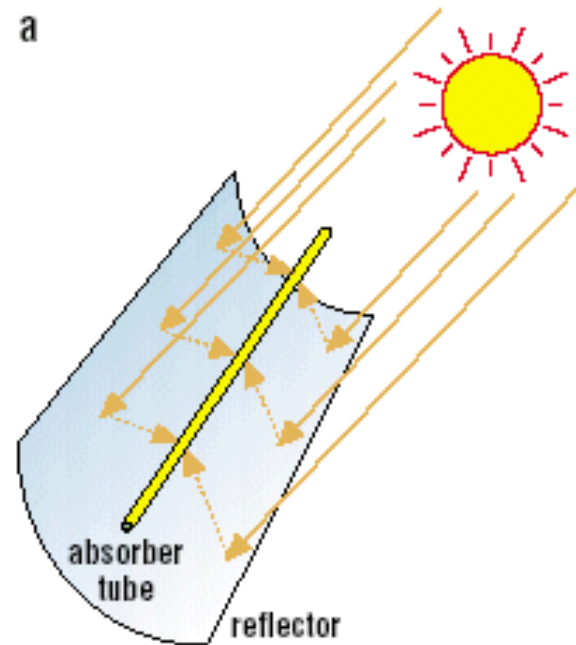

Storage system in a trough solar plant

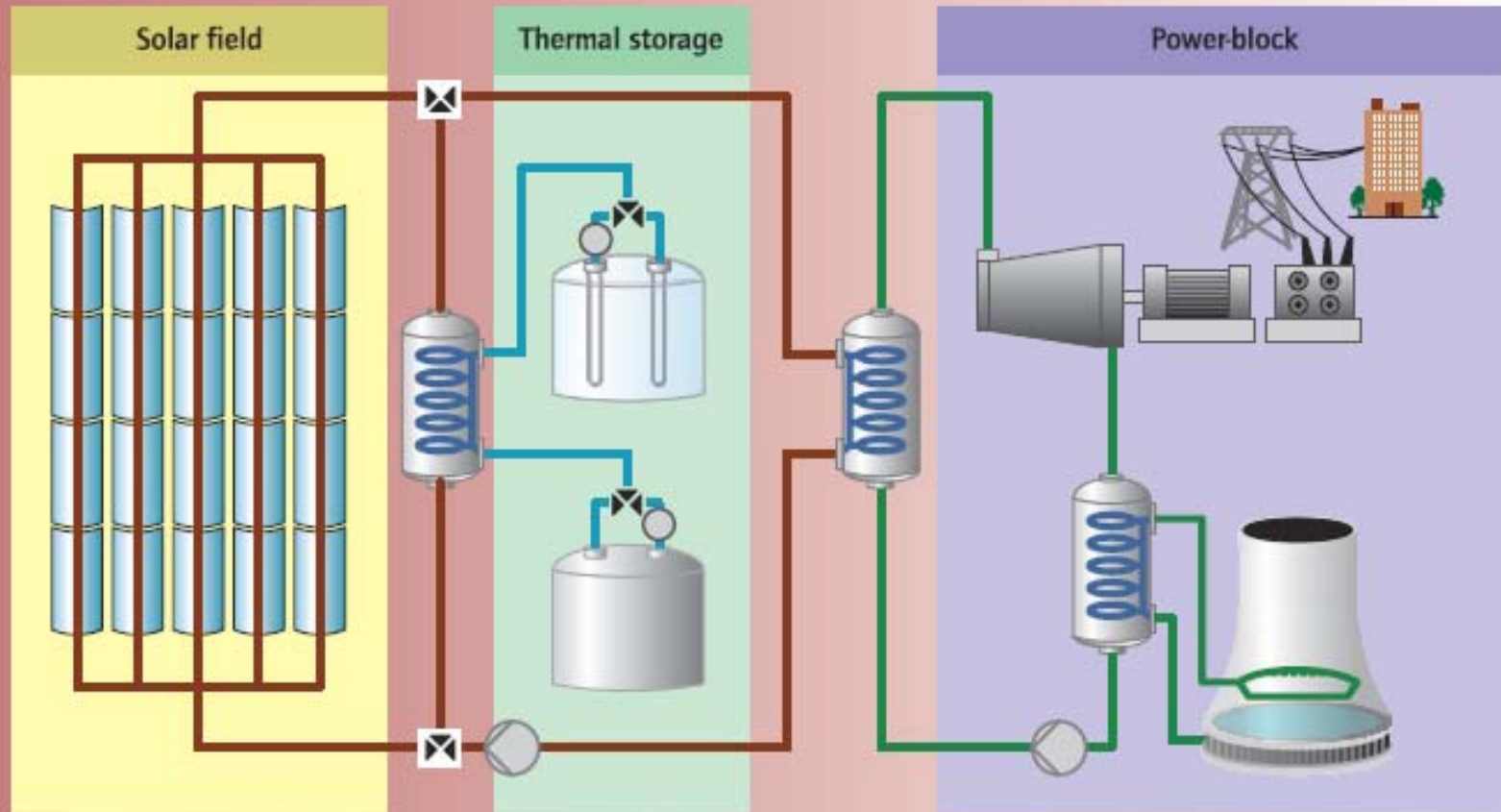

This graph shows how storage works in a CSP plant. Excess heat collected in the solar field is sent to the heat exchanger and warms the molten salts going from the cold tank to the hot tank. When needed, the heat from the hot tank can be returned to the heat transfer fluid and sent to the steam generator.

Source: SolarMillennium.

One of the key issues with CSP is the use of water, both in the process and to keep the collectors clean. Most sites with extreme sun are deserts, so water is at a premium.

Concentrating solar power systems:

Concentrating solar power systems use concentrated solar radiation as a high temperature energy source to produce electrical power and drive chemical reactions. These clean energy technologies are appropriate for **Sunbelt applications** where direct solar radiation is high.

The first commercial plants have been in operation in California since the mid-1980s, providing the 354 megawatts of the world's lowest-cost solar power. The many types of systems under development (including parabolic troughs, power towers, and dish/engine systems) for different markets vary according to the concentration devices, energy conversion methods, storage options and other design variables.



Concentrating solar power systems:



Much attention is focused on the multi-megawatt systems that are appropriate for the on-grid market, complementing the other major solar technology, photovoltaics, most appropriate for smaller, off-grid applications.

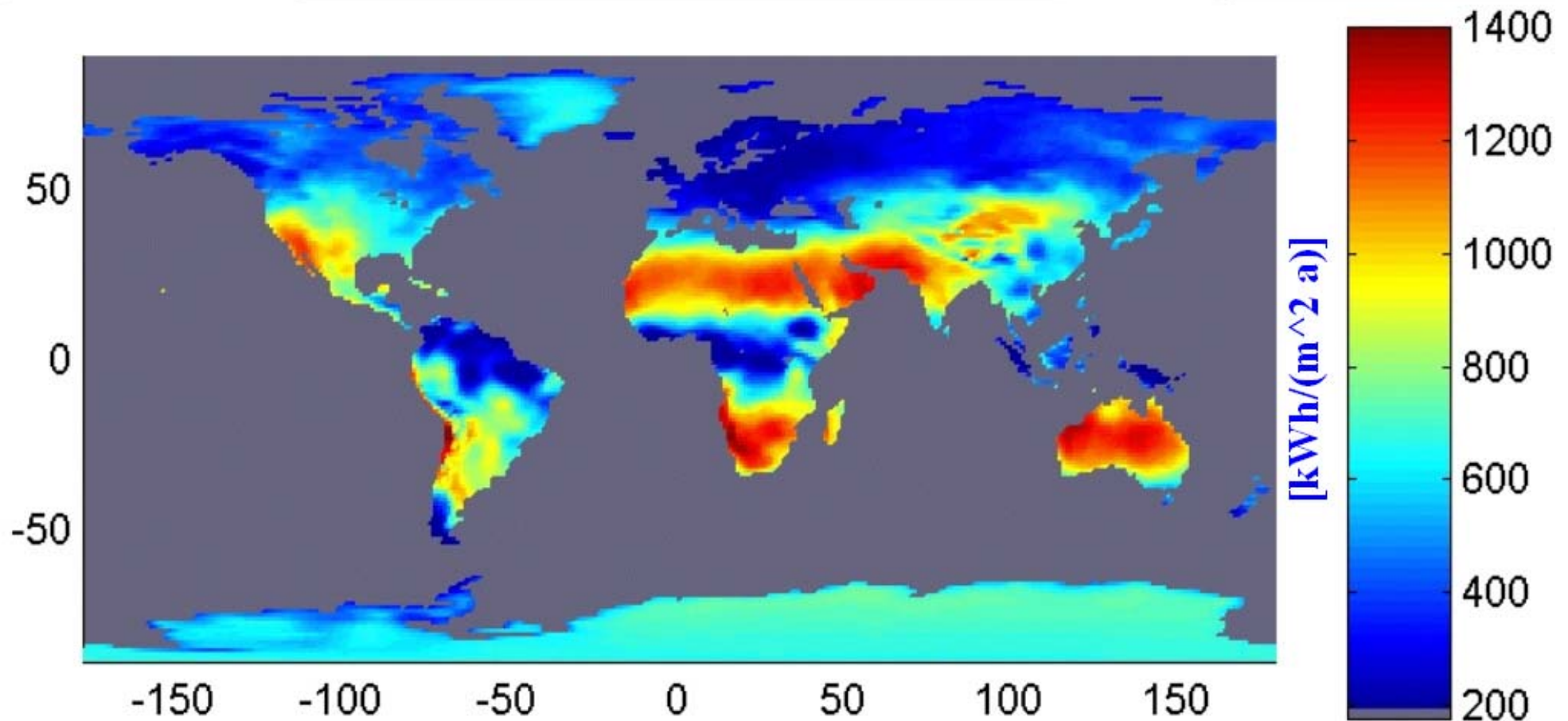

Heat Output of Solar Fields for SEGS (Solar Thermal Power Plants)

Met. data: ECMWF and NCEP

G. Czigisch, ISET, Vtrg. Mgdb. 2001



CSP viability:

The viability of large scale solar thermal installations is presently a function of the amount of solar energy available (hours AND intensity); the type of concentrator in question; and the efficiency of the system.

At present there are not any large scale solar thermal plants in Canada.

Figure 2. Annual Average Daily Total Solar Resources

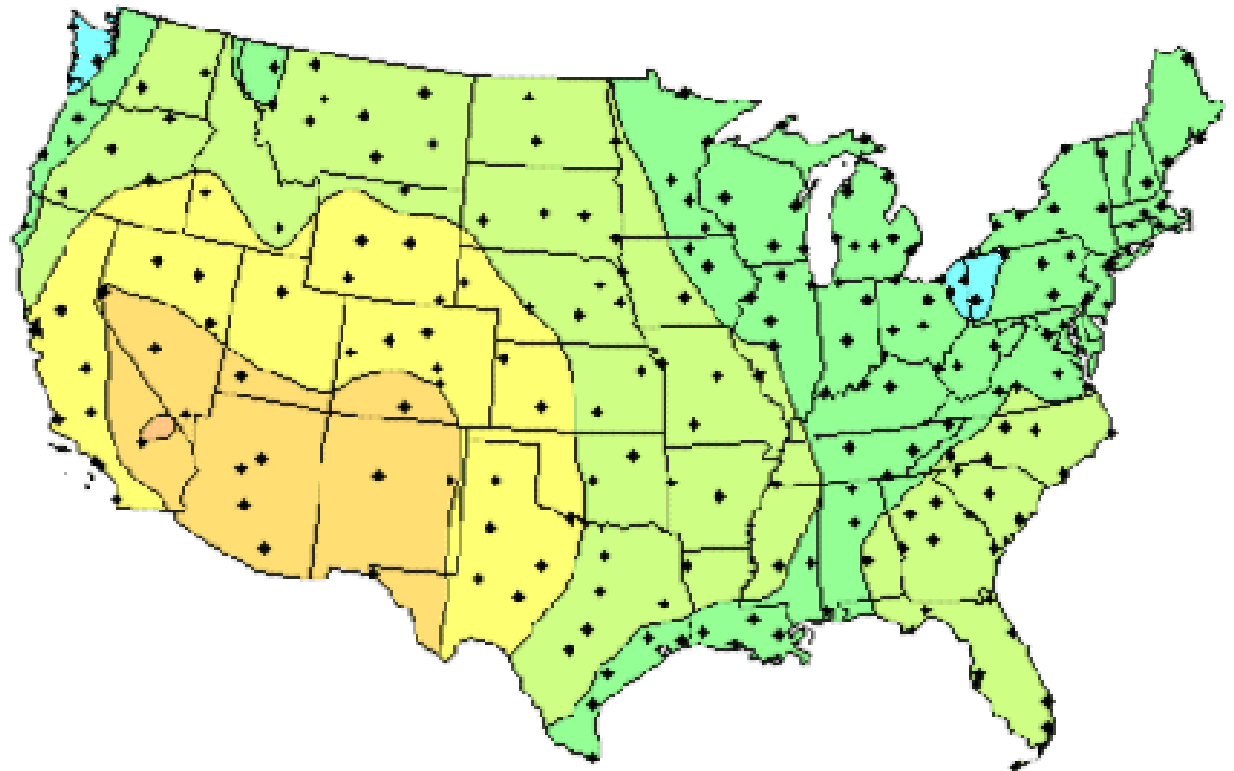

Two-Axis Tracking Concentrator

Electricity generation

Due to the poor part-load behaviour of solar thermal power, plants should be installed in **regions with a minimum of around 2000 full-load hours**. This is the case in regions with a direct normal irradiance of more than 2000 kWh/m² or a global irradiance of more than 1800 kWh/m². These irradiance values can be found in the earth's sunbelt; however, thermal storage can increase the number of full-load hours significantly.

The potentials for solar thermal power plants are enormous: **for instance, about 1% of the area of the Sahara desert covered with solar thermal power plants would theoretically be sufficient to meet the entire global electricity demand**. Therefore, solar thermal power systems will hopefully play an important role in the world's future electricity supply.

Utility scale power towers

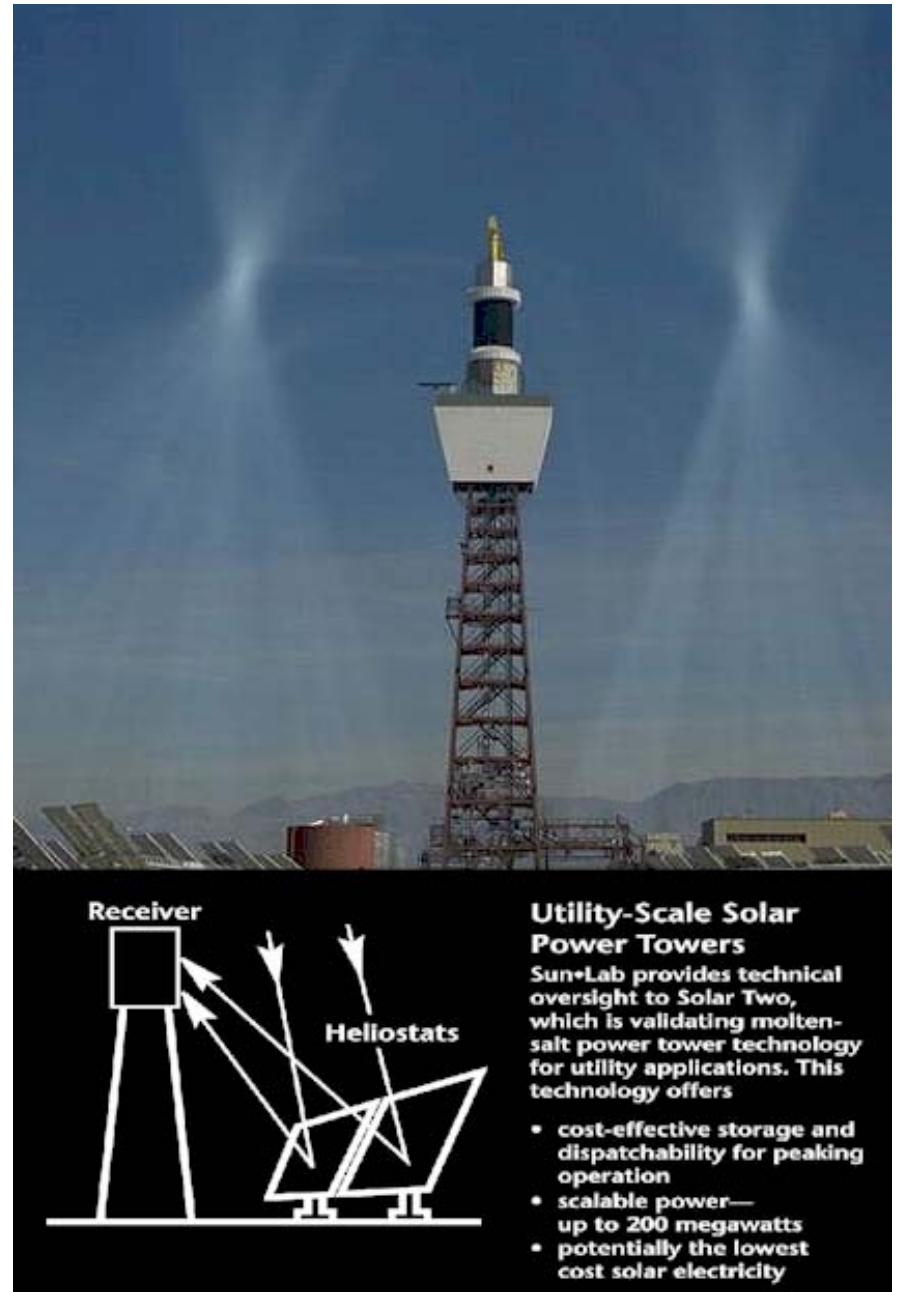

Utility scale power towers

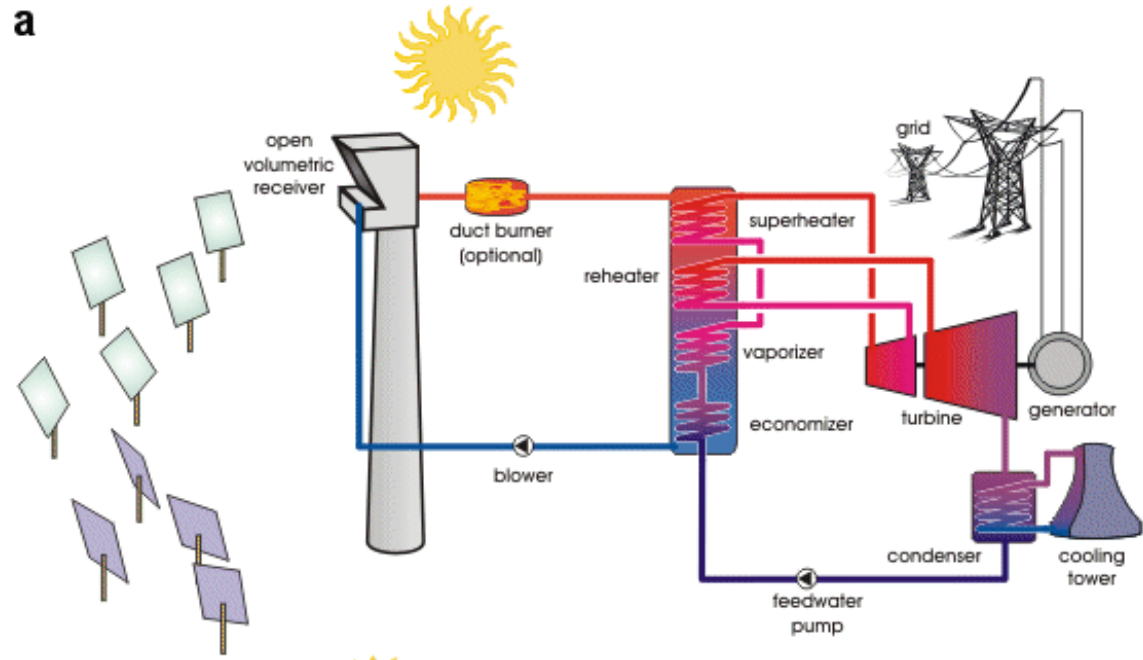

In solar thermal tower power plants, hundreds or even thousands of large two-axis tracked mirrors are installed around a tower. These slightly curved mirrors are also called heliostats; a computer calculates the ideal position for each of these, and a motor drive moves them into the sun. The system must be very precise in order to ensure that sunlight is really focused on the top of the tower. It is here that the absorber is located, and this is heated up to temperatures of 1000°C or more. Hot air or molten salt then transports the heat from the absorber to a steam generator; superheated water steam is produced there, which drives a turbine and electrical generator.



To optimize efficiency, these panels rotate to track the sun, directing the solar power to a tower that converts the light to electricity via a chemical conversion process.

Dish systems:

In the focus is a receiver which is heated up to 650°C . The absorbed heat drives a Stirling motor, which converts the heat into motive energy and drives a generator to produce electricity.

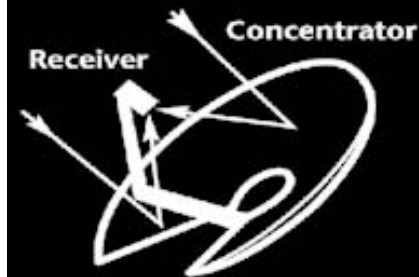
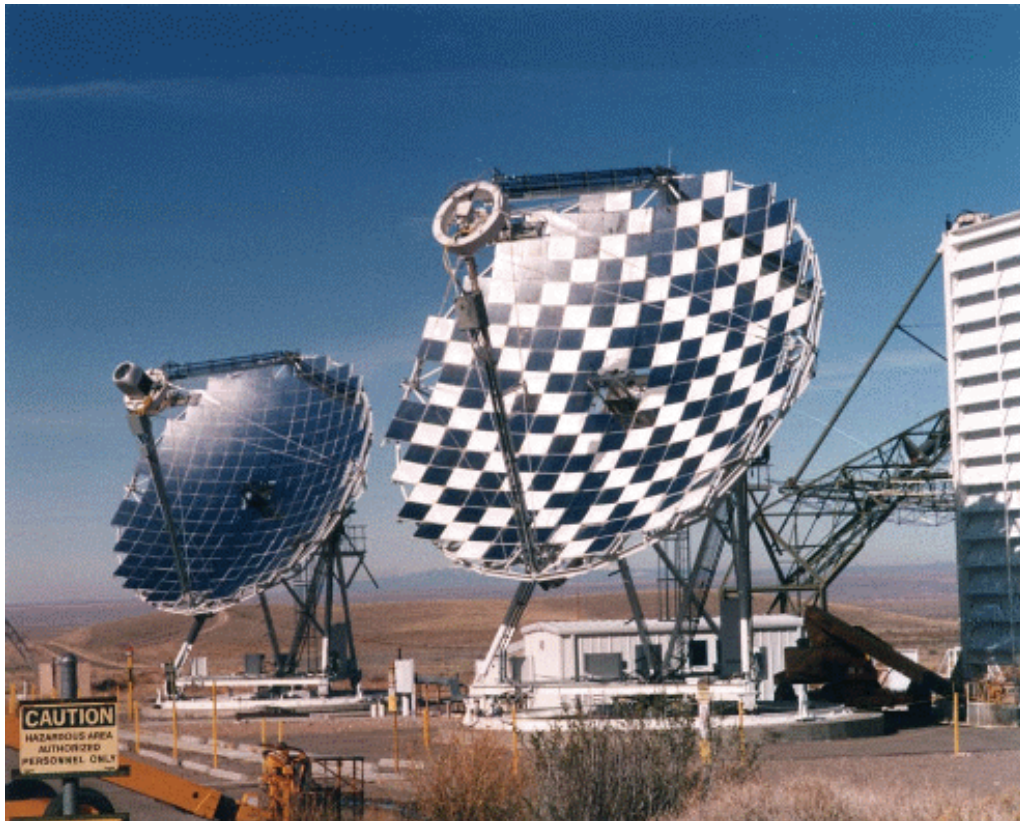

Dish/Stirling Systems

Sun•Lab engineers are working with industry to bring these promising solar electric systems to commercial readiness. These systems

- have demonstrated solar-to-electric efficiencies up to 29%
- offer modular technology for demands from 25 kilowatts to 10s of megawatts of electricity
- can be hybridized with fossil fuel systems to provide power when the sun is not shining

Parabolic trough systems:

The parabolic trough collector consists of large curved mirrors, which concentrate the sunlight by a factor of 80 or more to a focal line.



Concentrator

Receiver

Parabolic Trough Systems
The Department of Energy's Solar Thermal Program helped develop solar thermal trough technology, which currently has demonstrated 80 plant-years of operation. These systems offer

- practical, fielded operating experience
- 18% peak, 11% annual efficiency
- reasonable operating costs
- easy hybridization

The diagram shows a cross-section of a parabolic trough collector. It features a curved mirror (labeled 'Concentrator') that focuses sunlight onto a central receiver tube (labeled 'Receiver'). Arrows indicate the path of the sunlight from the mirror to the receiver.

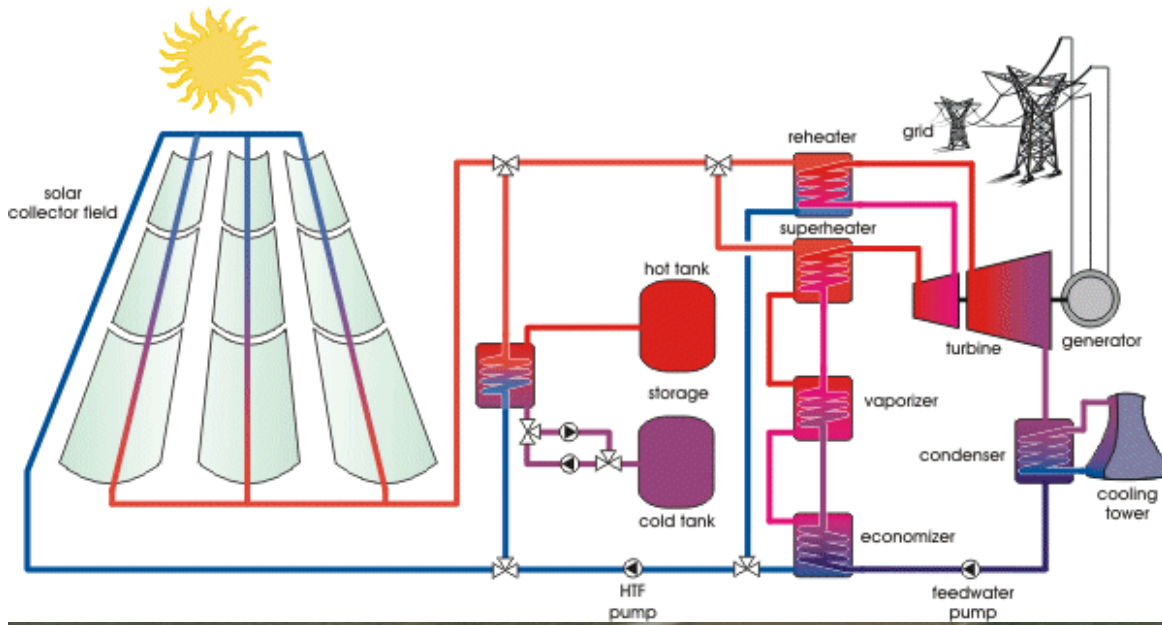

Solar Hot Water



Solar hot water:

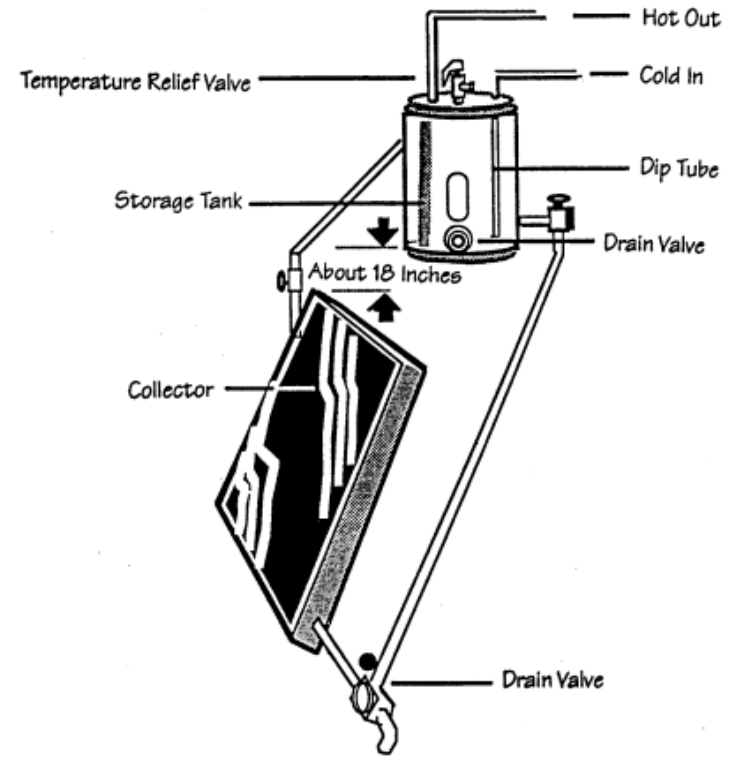
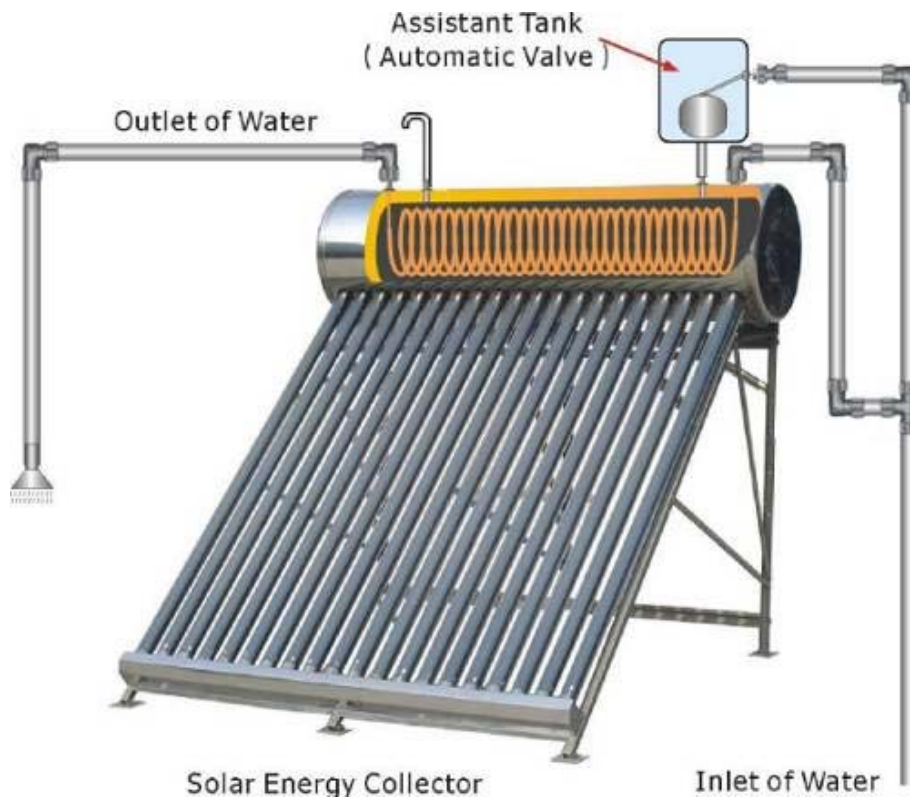

Solar hot water systems use the sun's energy to heat water for a variety of industrial and business uses.

Sunlight passing through glass or plastic glazing strikes a light absorbing material. The material converts the sunlight into heat, which is prevented from escaping by the glazing.

Solar hot water systems:

The most common types of solar collectors used in solar water heaters are flat plate and evacuated tube collectors. A flat plate collector consists of a shallow rectangular box with a transparent glass or plastic window covering a flat black plate. The black plate is attached to a series of tubes through which water or some other transfer fluid passes. An evacuated tube collector consists of several individual glass tubes, each containing a black metal pipe. The transfer fluid flows through these pipes. The space between the pipe and the glass tube is evacuated, in other words, the air is removed.

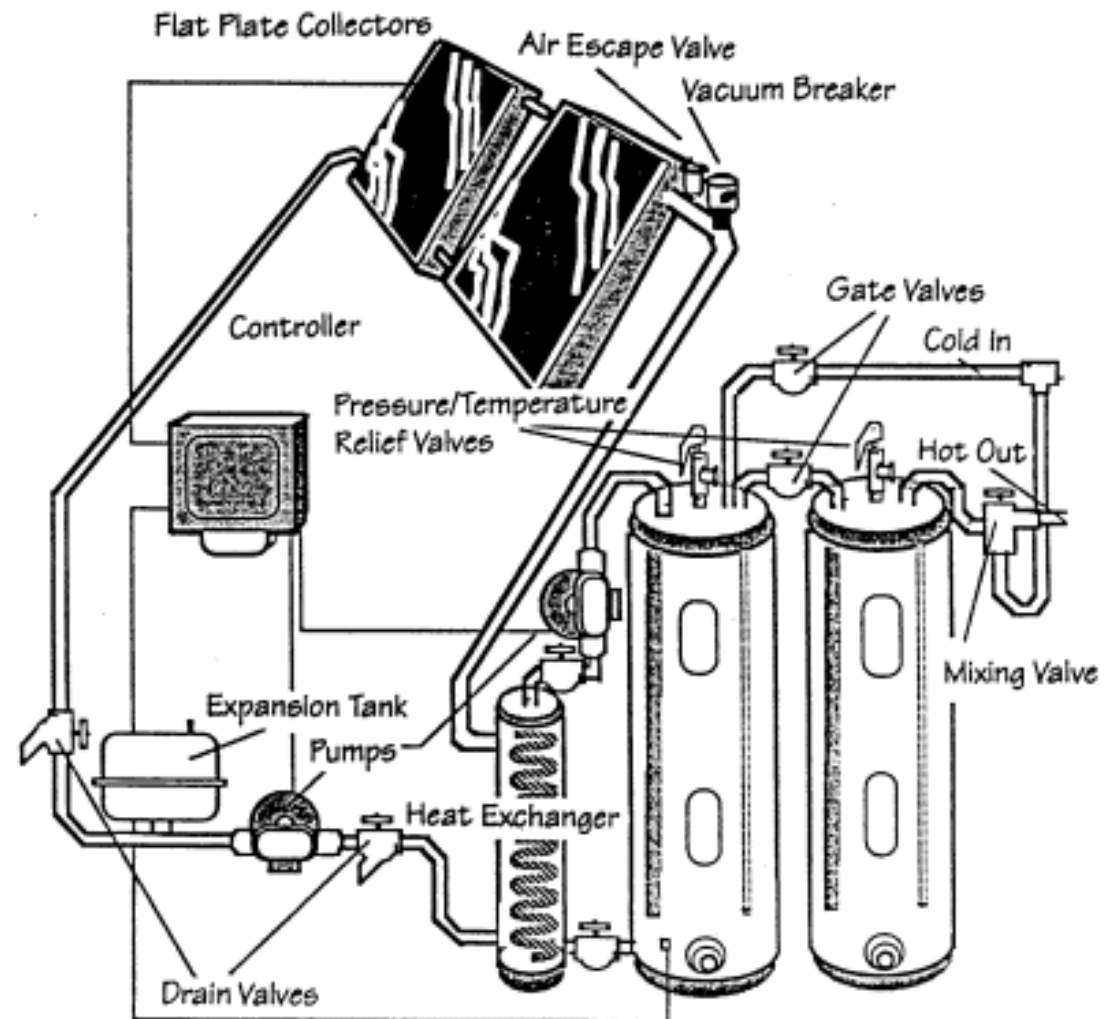

Flat plate collectors:

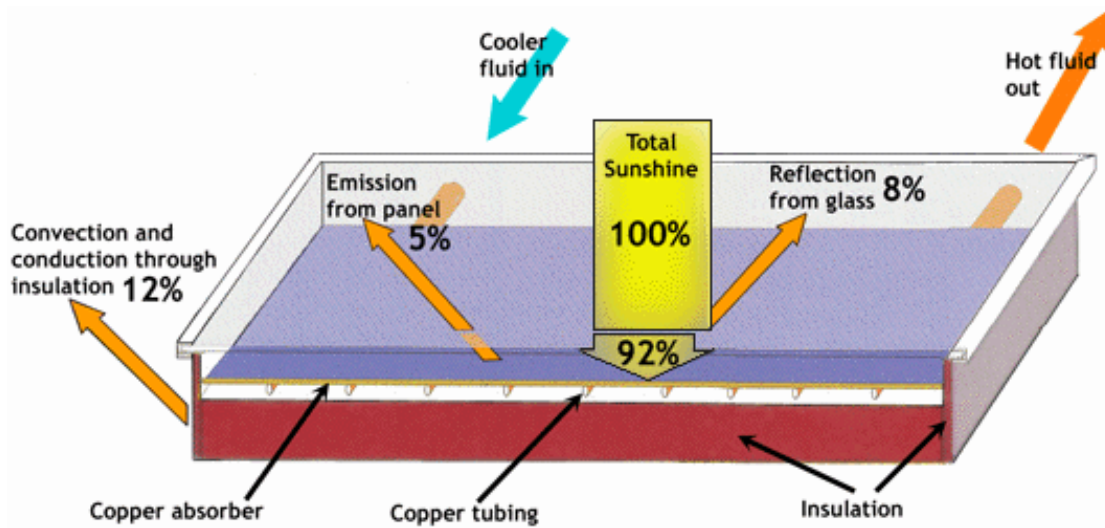

Allow one square metre of collector for every 45-50 litres of hot water to be stored.

Working towards a NET ZERO WATER status will make it more likely to be able to supply all of the hot water needs with a solar system.



Typical daily hot water usage

Appliance	Volume (litres)
standard sized bath	60
corner bath	120
shower / power shower	15-60
washing machine	50
kitchen sink	15
bathroom washbasin	5

Flat plate collectors:



Flat plate collectors:



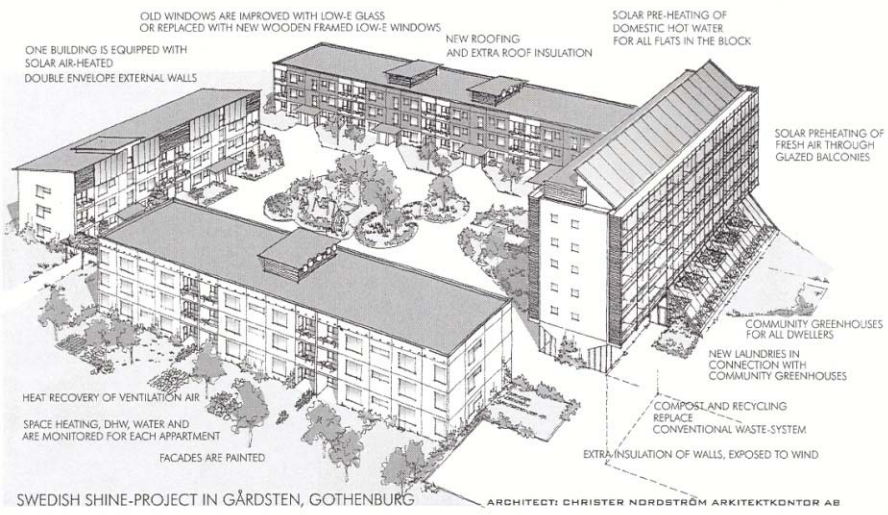

Top: birdview of one of three similar blocks describing the solar- and sustainable technologies.

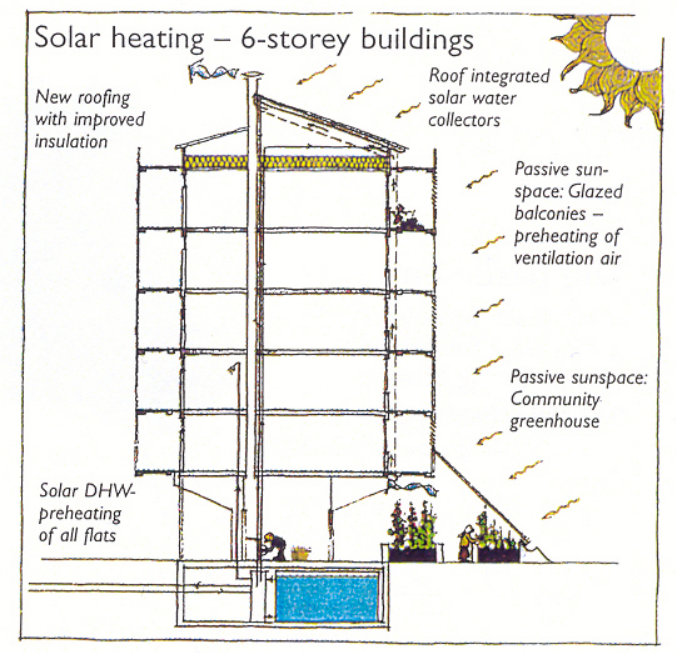

Vacuum tube collectors:



The vacuum tube collector uses a series of glass tubes that act like thermos bottles. The glass allows the light through, which heats up the fluid inside the inner tube. The vacuum between the layers of glass prevents that heat from escaping back to the atmosphere on cold days.



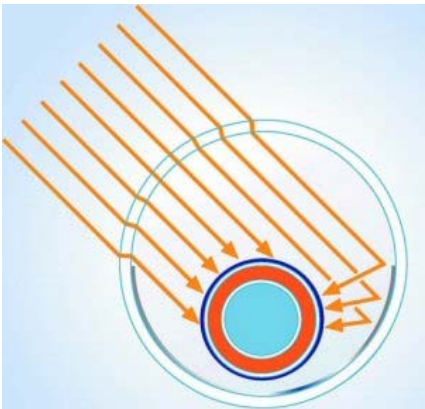
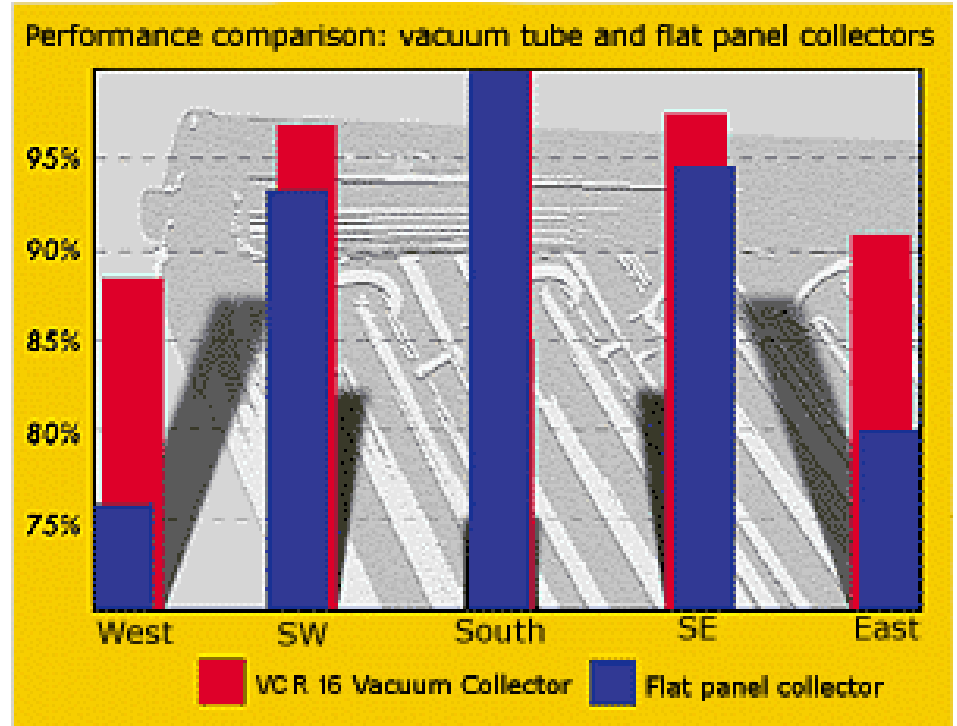

On warm, sunny days, the performance of the vacuum collector is equal to that of the flat collector. But it will increasingly outperform the flat collector as the outside temperature decreases or light levels are reduced.



PV

White Rock Operations Centre, Surrey, BC

Vacuum tube collectors



Evacuated tube system at Benny Farm Housing in Montreal.

Drake Landing



An antifreeze solution - a mixture of water and non-toxic glycol - is pumped through the solar collectors and heated whenever the sun is out. The 800 collectors are connected via an underground, insulated pipe that carries the heated solution to the community's Energy Centre. Once there, the heated solution passes through a heat exchanger, where the heat is transferred to the water in the short-term storage tanks. While the flow rate through the collectors is constant, the flow rate on the water side of the heat exchanger is automatically adjustable, allowing the control system to set a desired temperature rise.

Drake Landing – Flat Plate collectors



The houses also have flat plate collectors for domestic hot water heating.

Wind Systems

Wind, ultimately driven by sun-warmed air, is just another way of collecting solar energy, but it works on cloudy days....



Wind Systems:

There are four main parts to a wind turbine:

- the base,
- tower,
- nacelle, and
- blades.

The blades capture the wind's energy, spinning a generator in the nacelle. The tower contains the electrical conduits, supports the nacelle, and provides access to the nacelle for maintenance. The base, made of concrete and steel, supports the whole structure.

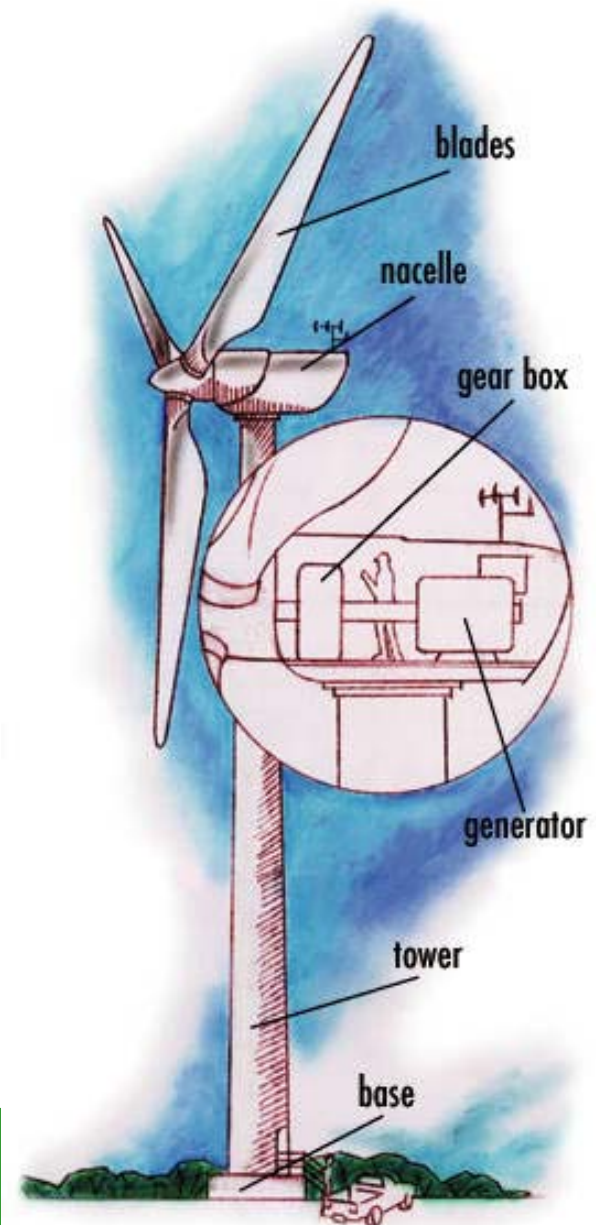

Wind Systems:

Designed like airplane wings, modern wind turbine blades use lift to capture the wind's energy. Because of the blade's special shape, the wind creates a pocket of pressure as it passes behind the blade. This pressure pulls the blade, causing the turbine to rotate. This modern blade design captures the wind's energy much more efficiently than old farm windmills, which use drag, the force of the wind pushing against the blades. The blades spin at a slow rate of about 20 revolutions per minute (RPM), although the speed at the blade tip can be over 150 miles per hour.

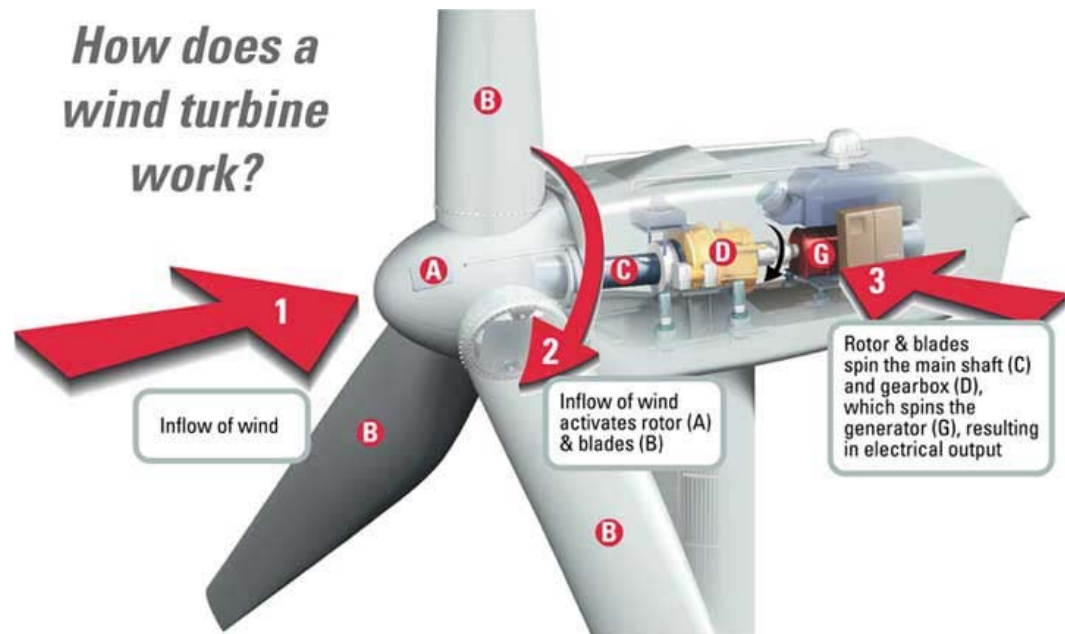

Nacelle

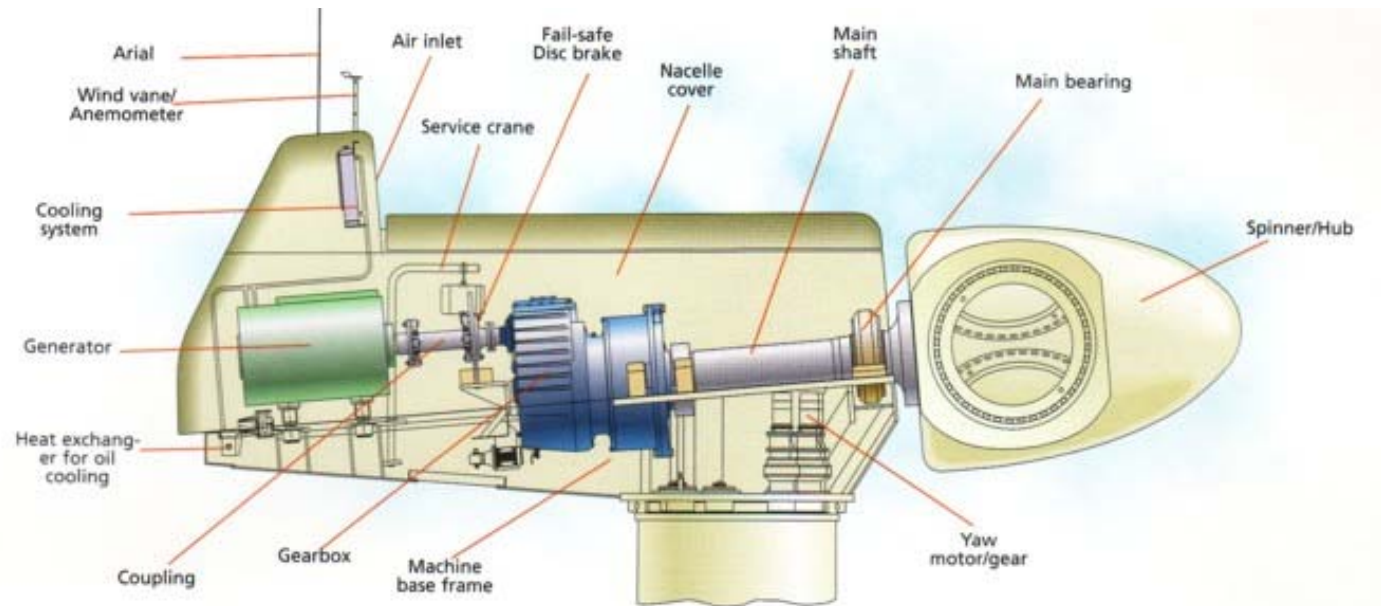

The **nacelle** houses a generator and gearbox. The spinning blades are attached to the generator through a series of gears. The gears increase the rotational speed of the blades to the generator speed of over 1,500 RPM. As the generator spins, electricity is produced. Generators can be either variable or fixed speed. Variable speed generators produce electricity at a varying frequency, which must be corrected to 60 cycles per second before it is fed onto the grid. Fixed speed generators don't need to be corrected, but aren't as able to take advantage of fluctuations in wind speed.

Tower design

The most common tower design is a white steel cylinder, about 150 to 200 feet tall and 10 feet in diameter.

Towers have a ladder running up the inside and a hoist for tools and equipment



Tower design

Some turbines use a lattice tower, like the Eiffel Tower.

Bases are made of concrete reinforced with steel bars. There are two basic designs. One is a shallow flat disk, about 40 feet in diameter and three feet thick. The other is a deeper cylinder, about 15 feet in diameter and 16 feet deep.

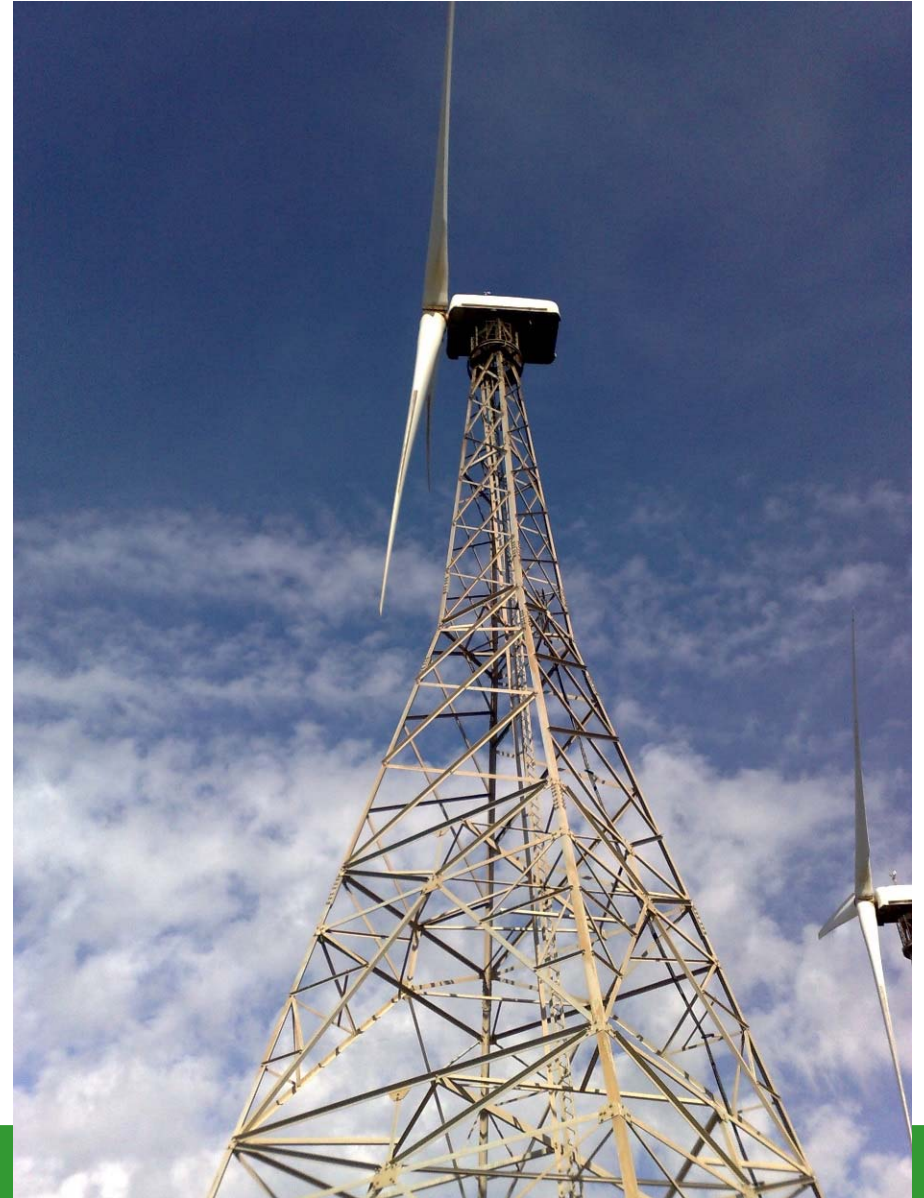

System appearance:

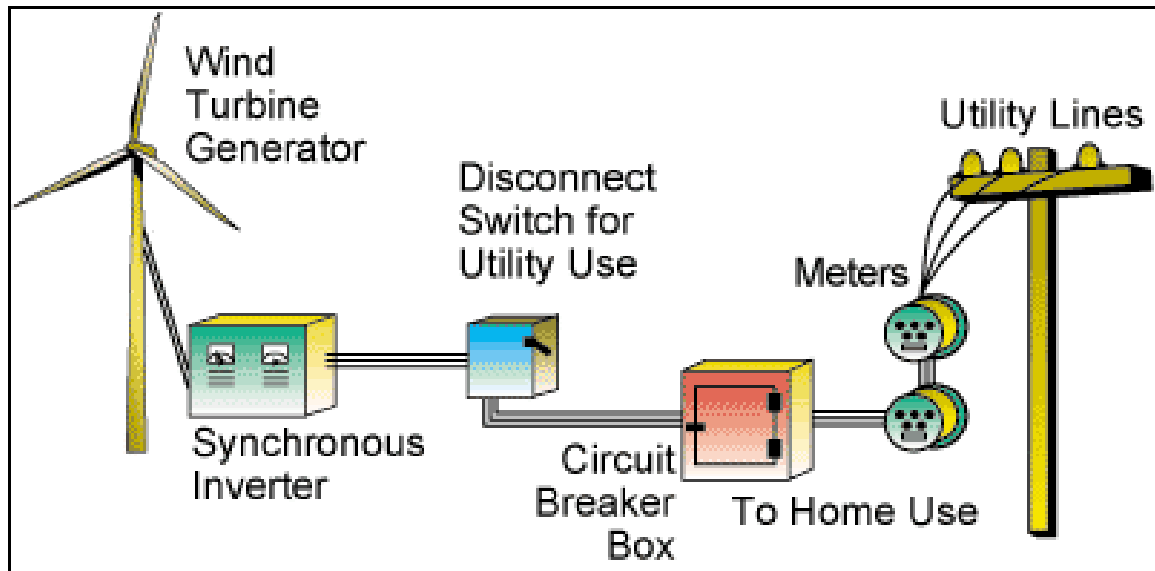

“ingredients” of the system similar to PV. Need an inverter to convert the energy to something “usable”.

Not all of the incoming wind energy becomes electricity. Some passes by. Some is lost in the conversion process.

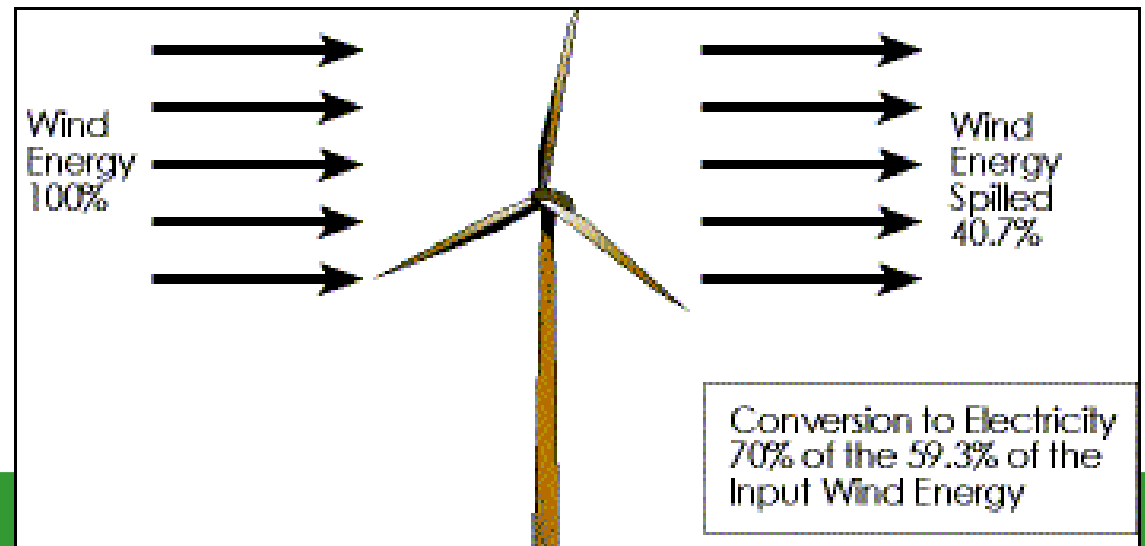

Wind Farm set up

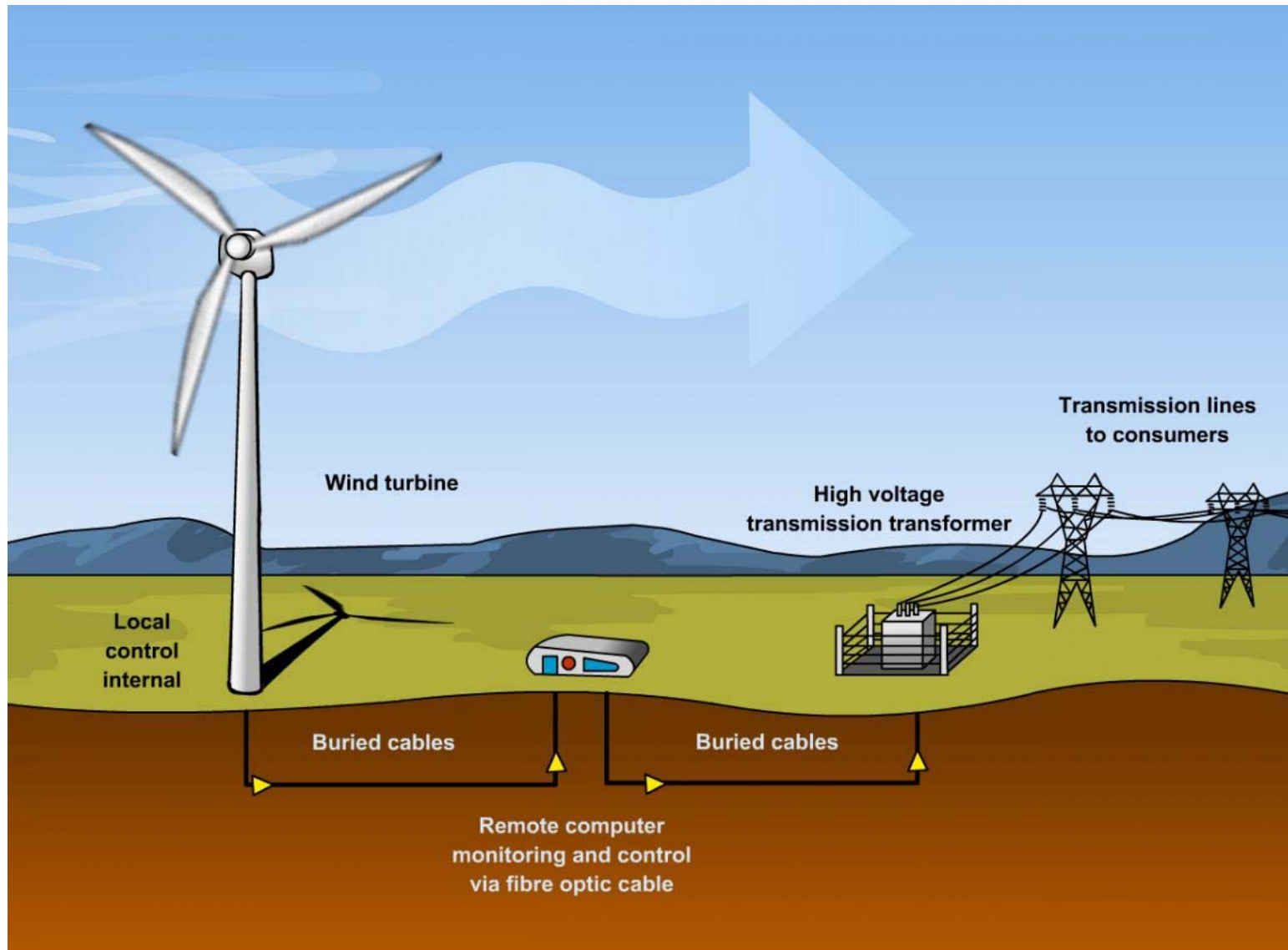

Horizontal axis type

Wind turbines with two or three thin blades, which rotate at high speeds, provided electricity to many farms beyond the reach of power lines.

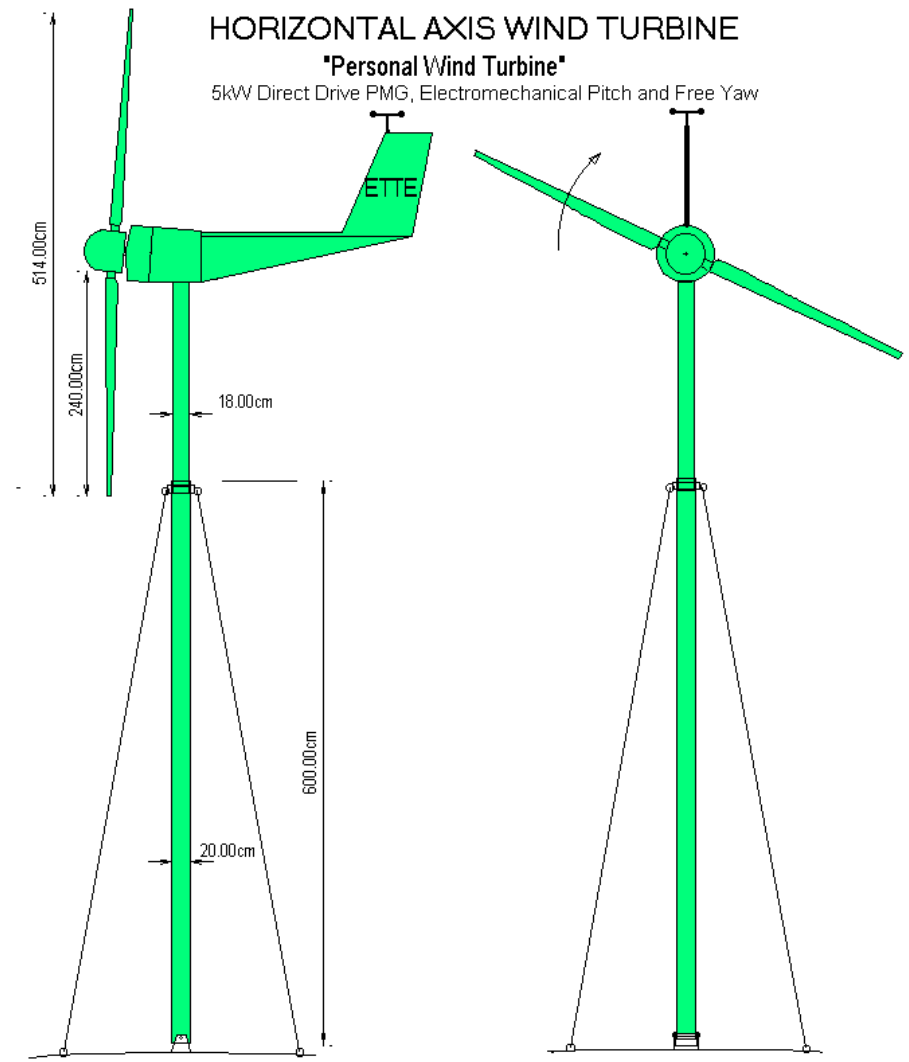
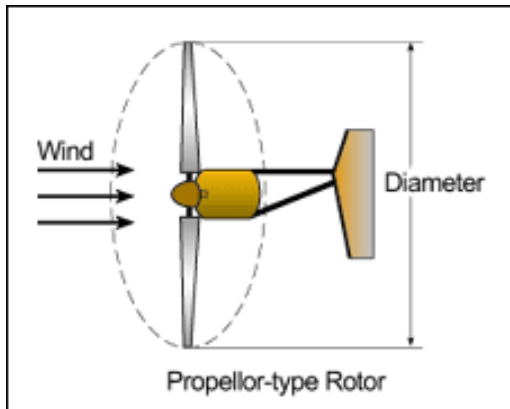
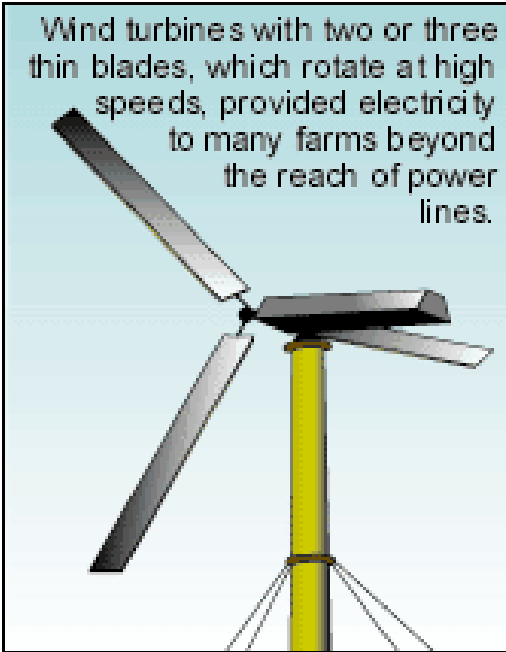

Gunnar Ettestøl, ETTE Elektro, 4985 Vegårshei, Norway, e-mail: gunnar@ette.no

Vertical axis type:

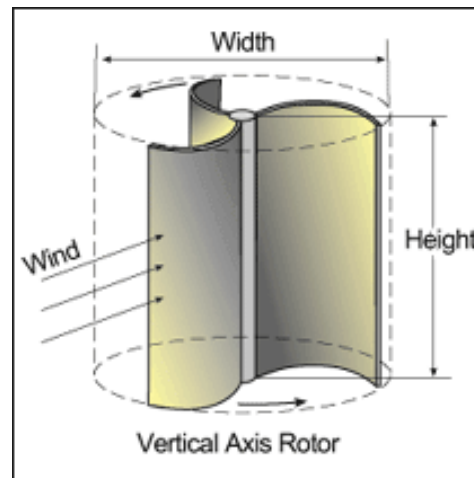
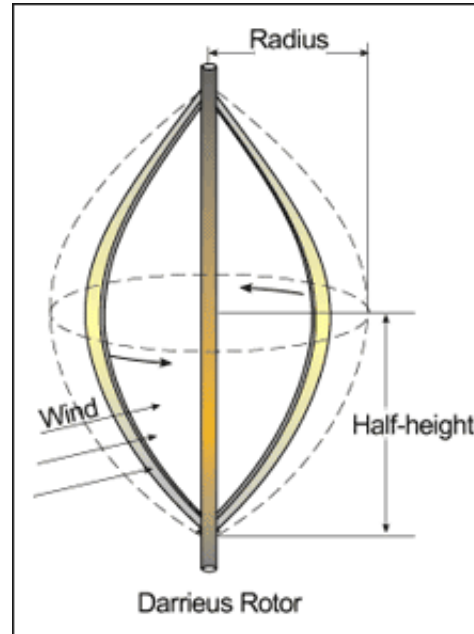
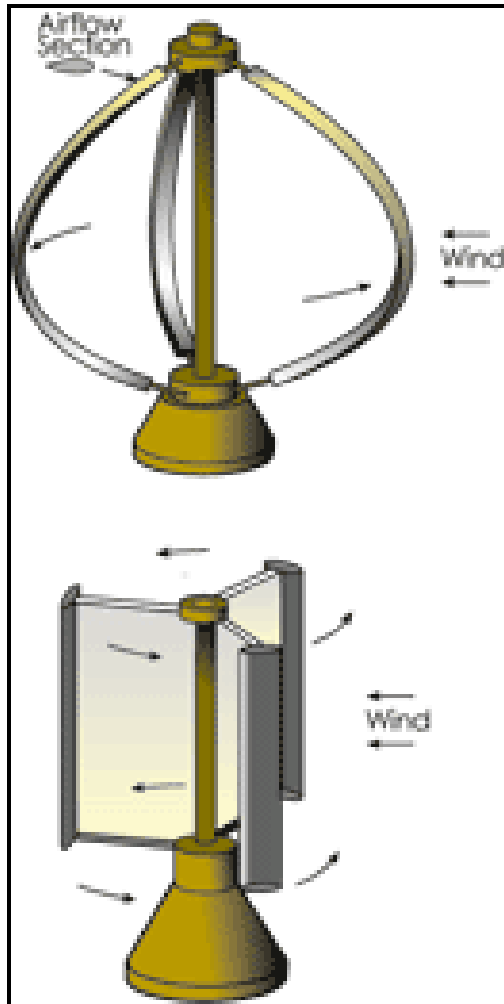

These are known as egg beaters. They are not as efficient as the horizontal axis type, so are less often used.





There are variations under study but not many are to be found as they have not proven to be more efficient.



Horizontal Axis Wind Turbines

Capacity factor:

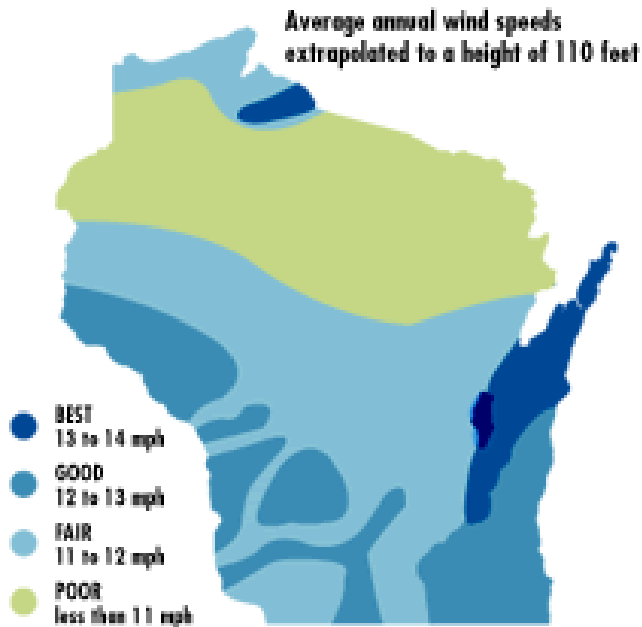

Above is a map of Wisconsin showing wind speeds.

These must be measured at the height of the centre of the turbine to assess its capacity.

Winds can be too low to be useful, but they can also be too high.

The productivity of a wind turbine, or any kind of power plant, is referred to as the capacity factor.

The capacity factor is the amount of power produced in a given time period compared to what the generator could produce if it ran at full capacity for that time period.

If a generator ran full out all the time, it would have a capacity factor of 100 percent, but no power plant runs all the time. In a good location, a wind turbine may produce on average a third of the maximum power of the generator, or have a 33 percent capacity factor.

Typical capacity factors are 20 to 25 percent.

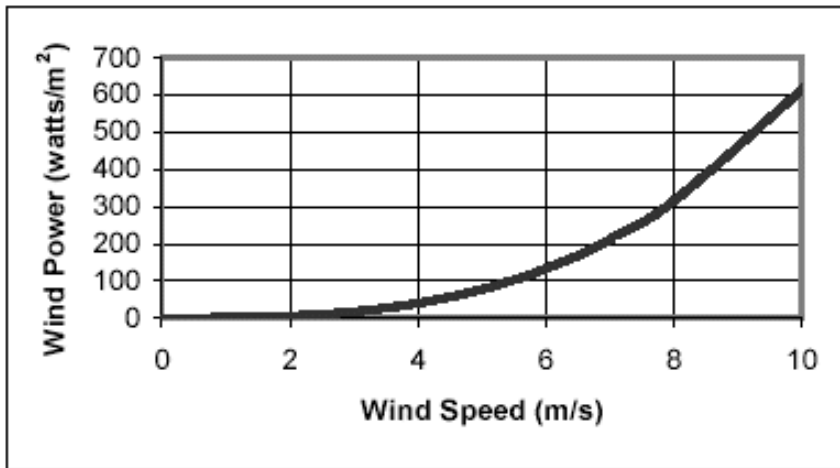

Wind power generally increases with the height of the tower.

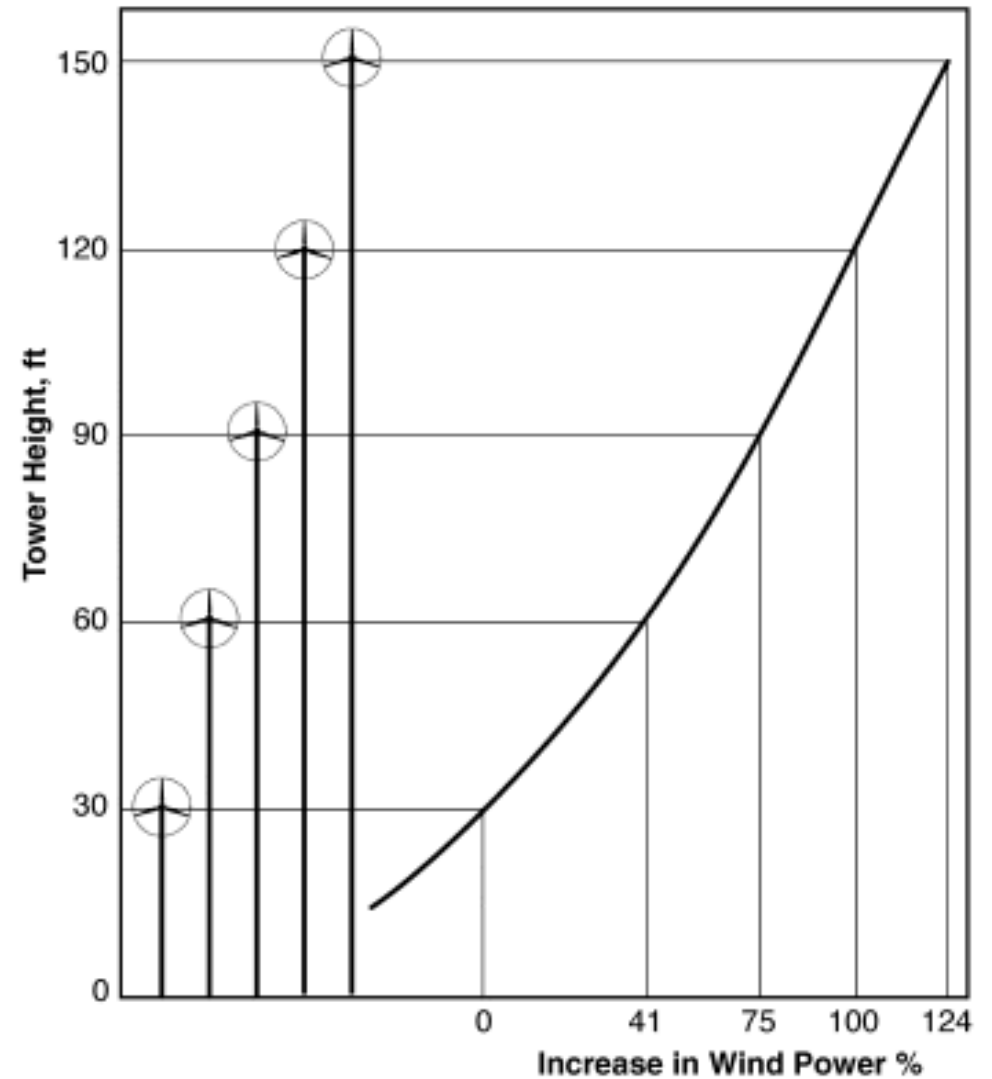











How much wind is enough?

Rotor blades need to be strong, light and durable. These qualities become more elusive as blade length increases. Recent advances in fibreglass and carbon-fibre technology have enabled the production of lightweight rotor blades (usually two or three per turbine) between 20 and 30 metres long. These blades are capable of performing for years in the rugged conditions of some of the world's windiest locations. Turbines with blades of this length can generate up to 1 megawatt of power.

A drawback to wind power is that the wind can be erratic, changing direction by the hour. There may be no wind at all one day and a howling gale the next. It may blow hard at times when electricity demand is low, and be a mere gentle breeze when demand is high.

But many of the problems of wind power are now being solved. For example, locating wind turbines in areas where the wind blows regularly and at optimum speeds would be a good way to start. There are other relatively simple tricks to catching the wind. For example, the wind is slowed by friction with the land surface. Modern wind turbines are therefore mounted on towers 40-60 metres high to expose the blades to a higher wind speed. The towers themselves are simple tubular steel columns.

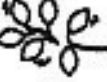
BEAUFORT WIND SCALE

#	m/s	Common signs for recognition	
0	0-1		Smoke rises vertical
1	1-2		Smoke drifts slowly
2	2-3		Leaves just move
3	4-5		Leaves move constantly
4	6-8		Small branches move
5	9-11		Small trees sway
6	12-14		Large branches move
7	15-17		Large trees sway
8	18-20		Small branches break
9	21-24		Large branches break
10	25-28		Small trees uprooted

Wind Turbine Issues

Birds

- Wind turbines in North America kill an average of 2 birds per year, per turbine. In comparison, house cats in Canada kill an estimated 140 million birds a year.

Sound

- The wind turbine will generate sound levels of approximately 43 decibels (as measured at a distance of 250 meters). In a quiet suburban residential neighbourhood, typical background noise levels range from 48-52 decibels



Noise?

And how much is too much for comfort?

One of the major issues with wind installations is the potential noise that is created by the turbines. It is good to compare noise generation to common noises to assess the impact on the environment.

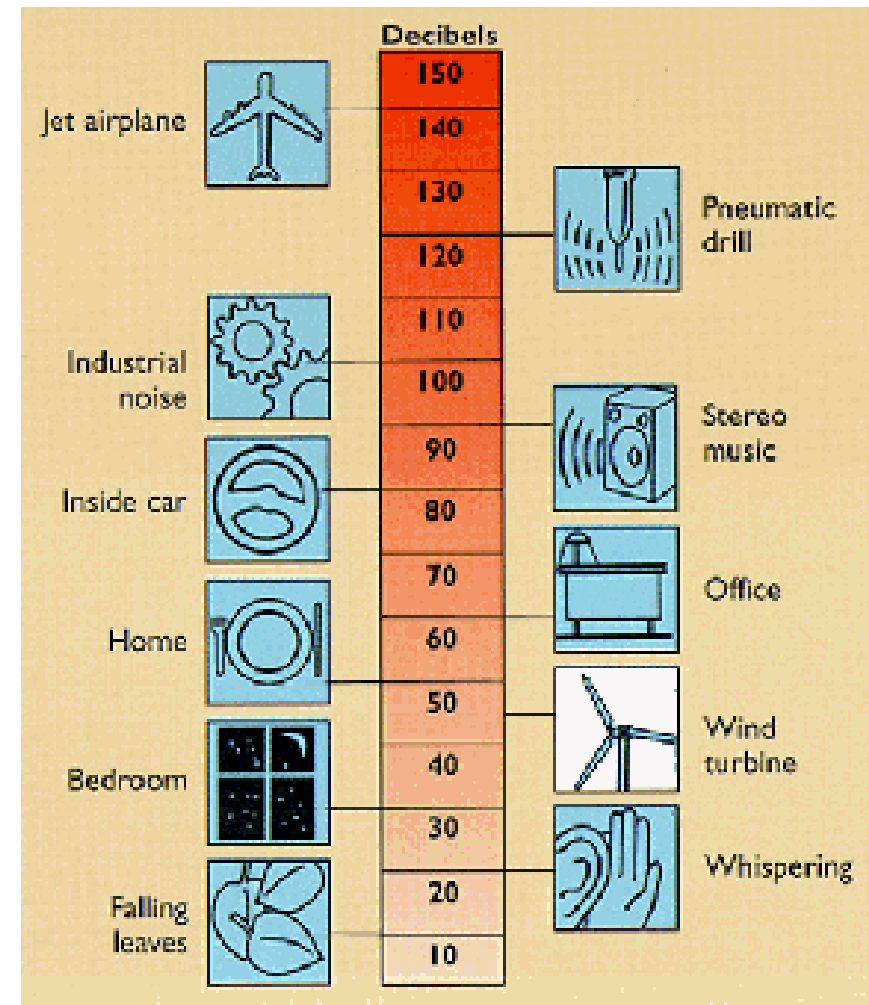

Noise?

How Loud Is A Wind Turbine?

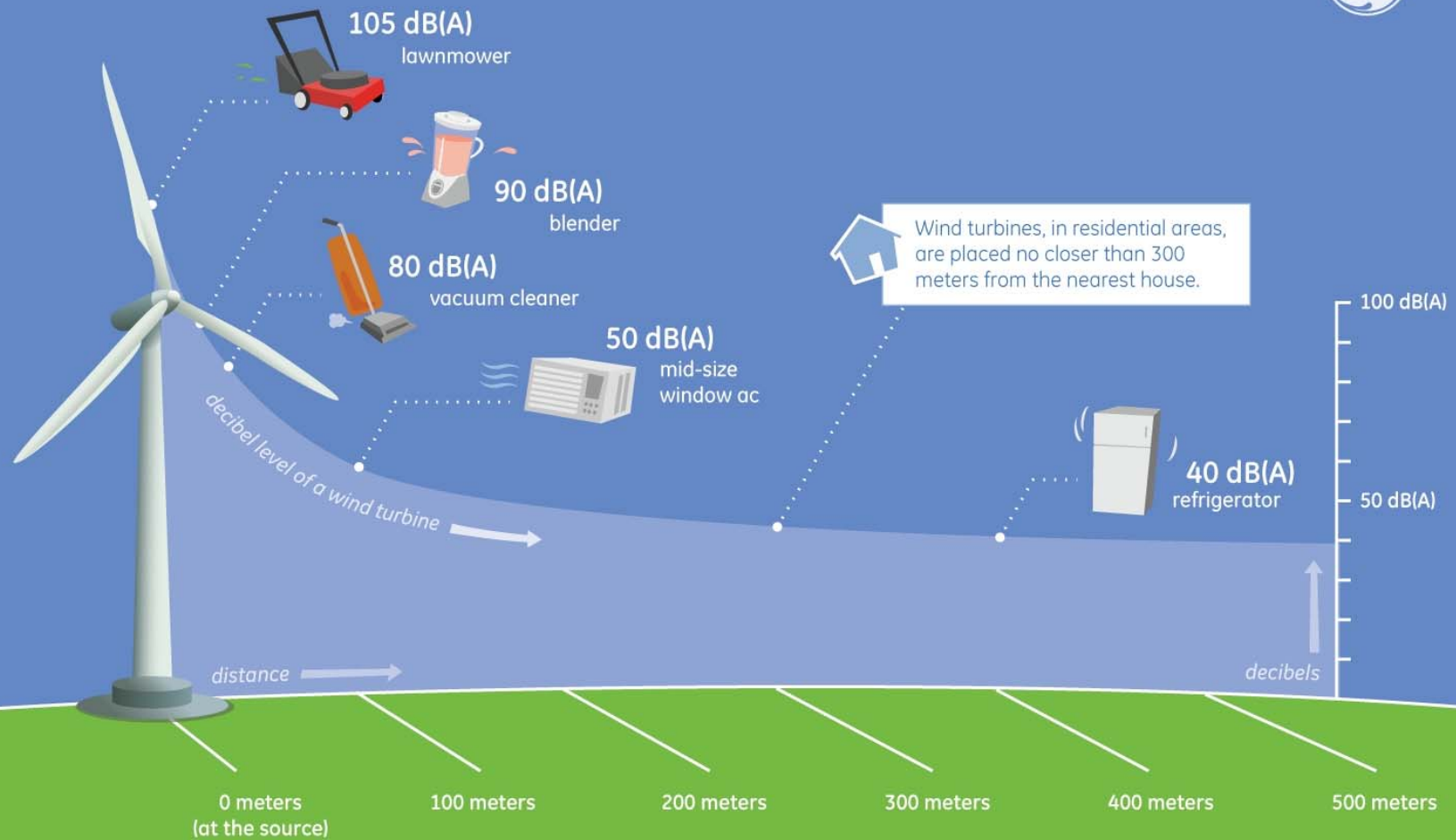

SOURCE: GE Global Research; National Institute of Deafness and Other Communication Disorders (NIDCD part of NIH)

Sound pollution from wind turbines

Wind turbines create noise from either the blades moving through the air or from the mechanical hub that produces the electricity. Sounds from wind turbines are a problem for some who live closest to the machines.

2 Pulsing sounds

Outdoors Turbines may appear to move slowly, but the tips of their blades often reach speeds of more than 100 mph. This, coupled with wind conditions that may include faster-moving air at the top of the arc and slower winds at the bottom, can produce a pulsing or oscillating sound.

Indoors Low-frequency sounds can penetrate walls and windows and are sensed as vibrations and pressure changes.



5 Shadows

The flickering shadows of rotating turbine blades at certain times of the day can also disturb residents.

4 Distance differences

Standing beneath a turbine may not be as noisy as standing further away. Depending on wind conditions, some types of sound increase with distance before becoming quieter.

1 Air-foil turbulence

Sound is generated by air moving over the surface of the blade or at the trailing edge of the blade called "vortex shedding."



3 High-pitched sounds

Some noise may come from the nacelle, or hub: a high-pitched whining similar to a jet engine, but not as loud.

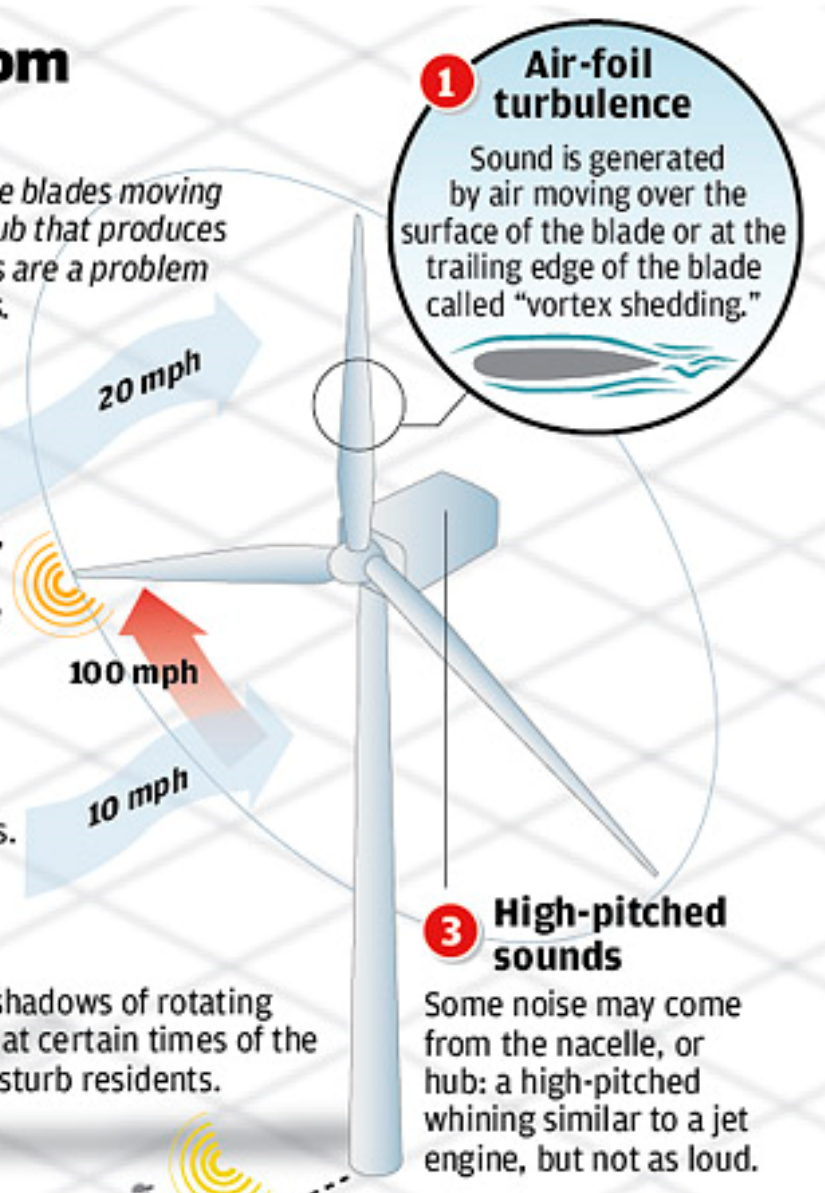

Battery storage



Wind available in interior Canada is not as great as could be for effective wind farming. Offshore applications are more effective.

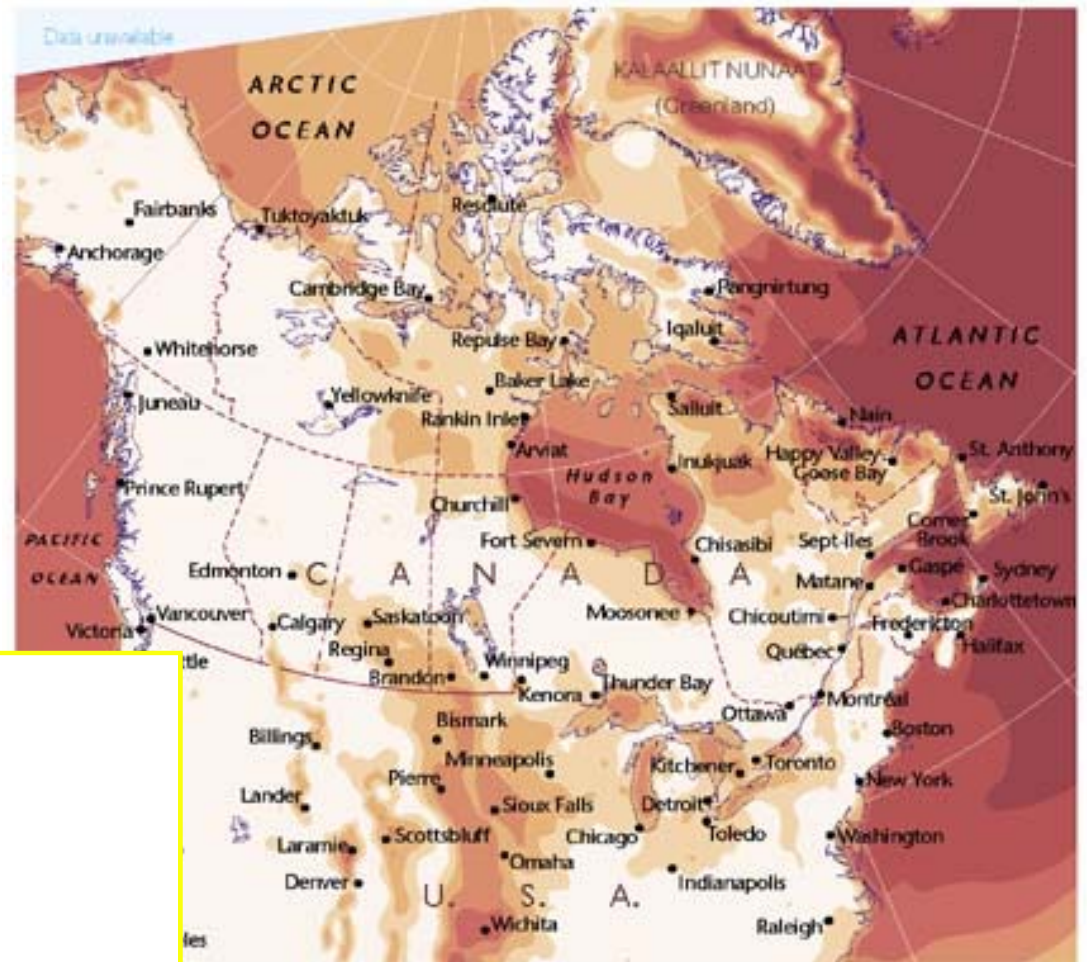

Average Annual Wind Power

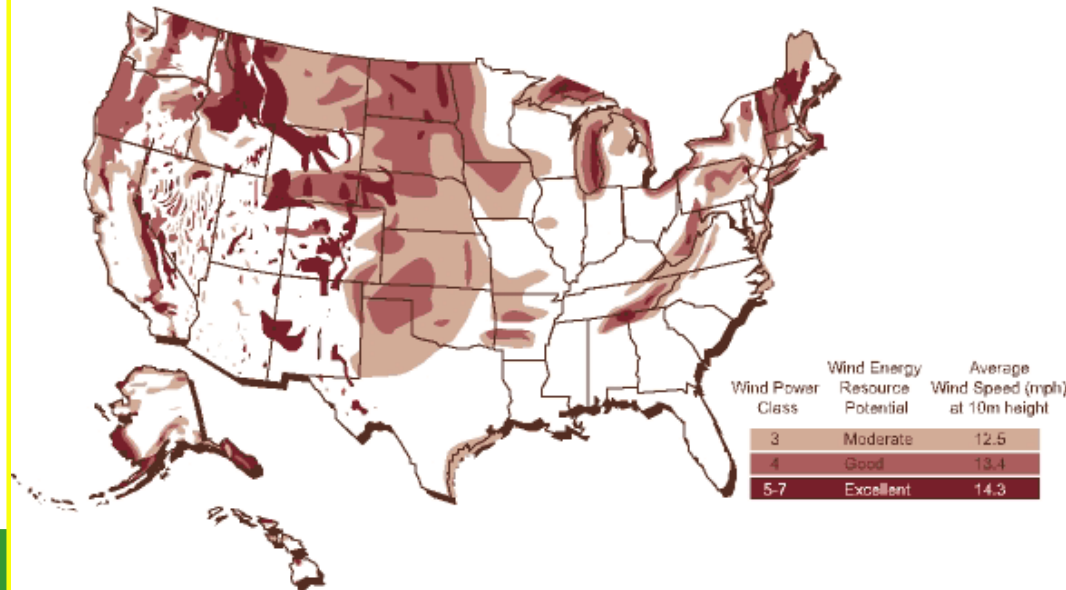

Canadian Wind Power Plans

Wind power generation, by province (megawatts) – summer 2006

PROVINCE	INSTALLED	PROPOSED	
British Columbia		3	25
Alberta	285	235	
Saskatchewan	17	125	
Manitoba	10	40	
Ontario	221	1,059	
Quebec	212	1,244	
New Brunswick	0		20
Nova Scotia	41	61	
Prince Edward Island	14	39	
Newfoundland	1		0
Yukon	1	0	

Canada Wind Power Capacity

Canada's installed wind power capacity (megawatts)

2000	137
2001	198
2002	236
2003	322
2004	444
2005	683
2006*	1,049*to June 30

SOURCE: CDN. WIND ENERGY ASSOCIATION

Canada Wind Power Capacity 2013

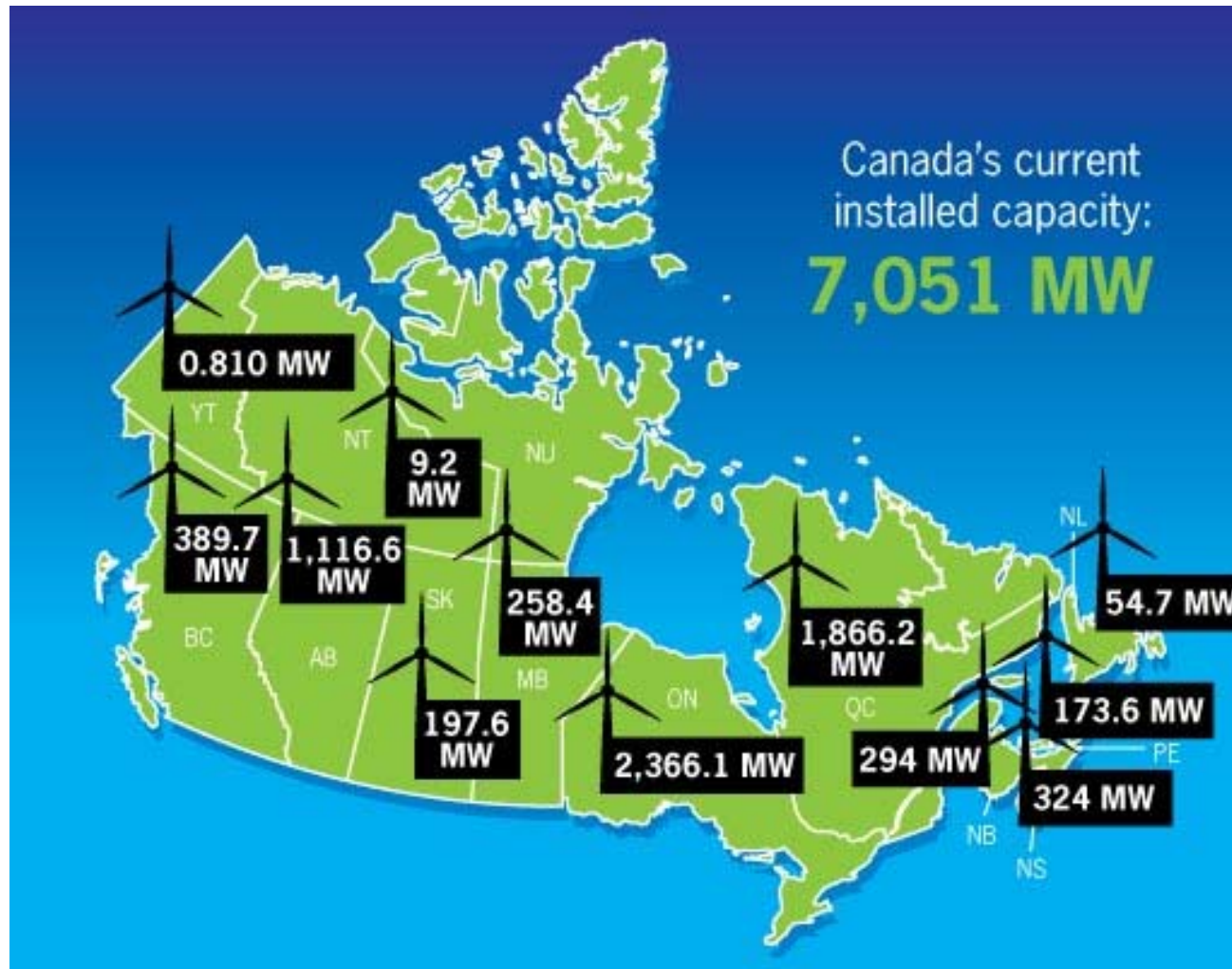

US Wind Power Distribution 2011

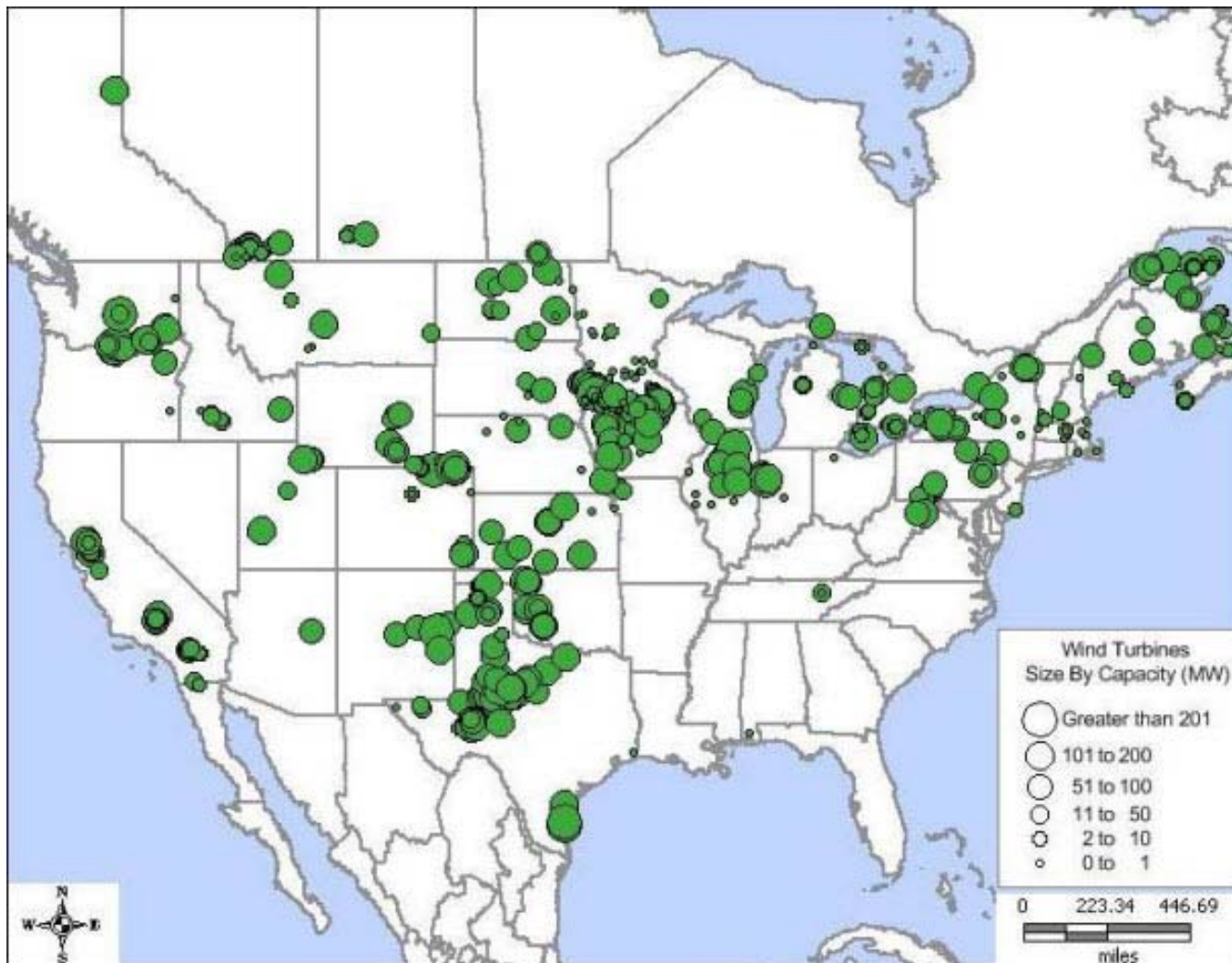

Mean Annual Production of 1.5 MW Variable Speed Wind Turbines (HH = 80 m) on Land Sites in Europe and its Neighbourhood

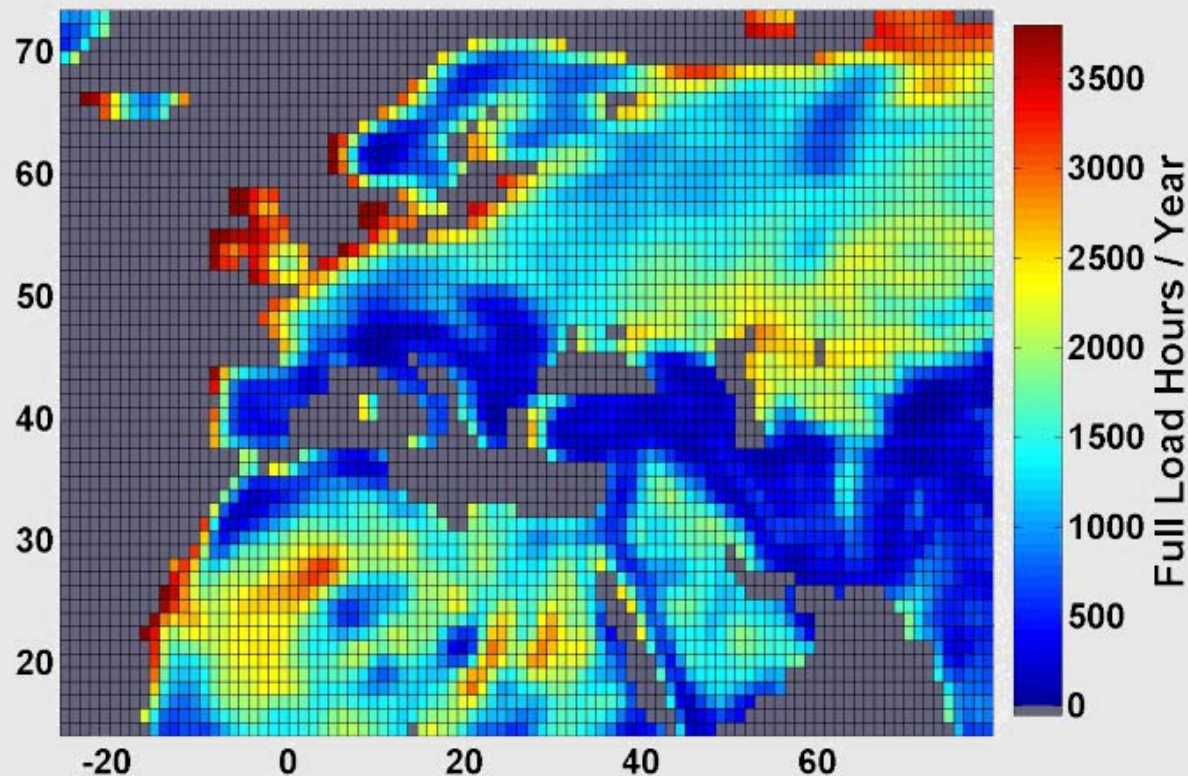

Electricity Demand

EU & Norway:

2100 TWh

Potential Wind Energy
Prod. on land sites with
more than 1500 FLH

at 4 – 8 MW/km²:

120 000 – 240 000 TWh

Mean Prod. at this sites:

2050 FLH

Meteorological data: ECMWF, ERA-15, 1990

G. Czisch, ISET, Vtrg. Mgdb. 2001



Wind Energy Capacity Installed/Year

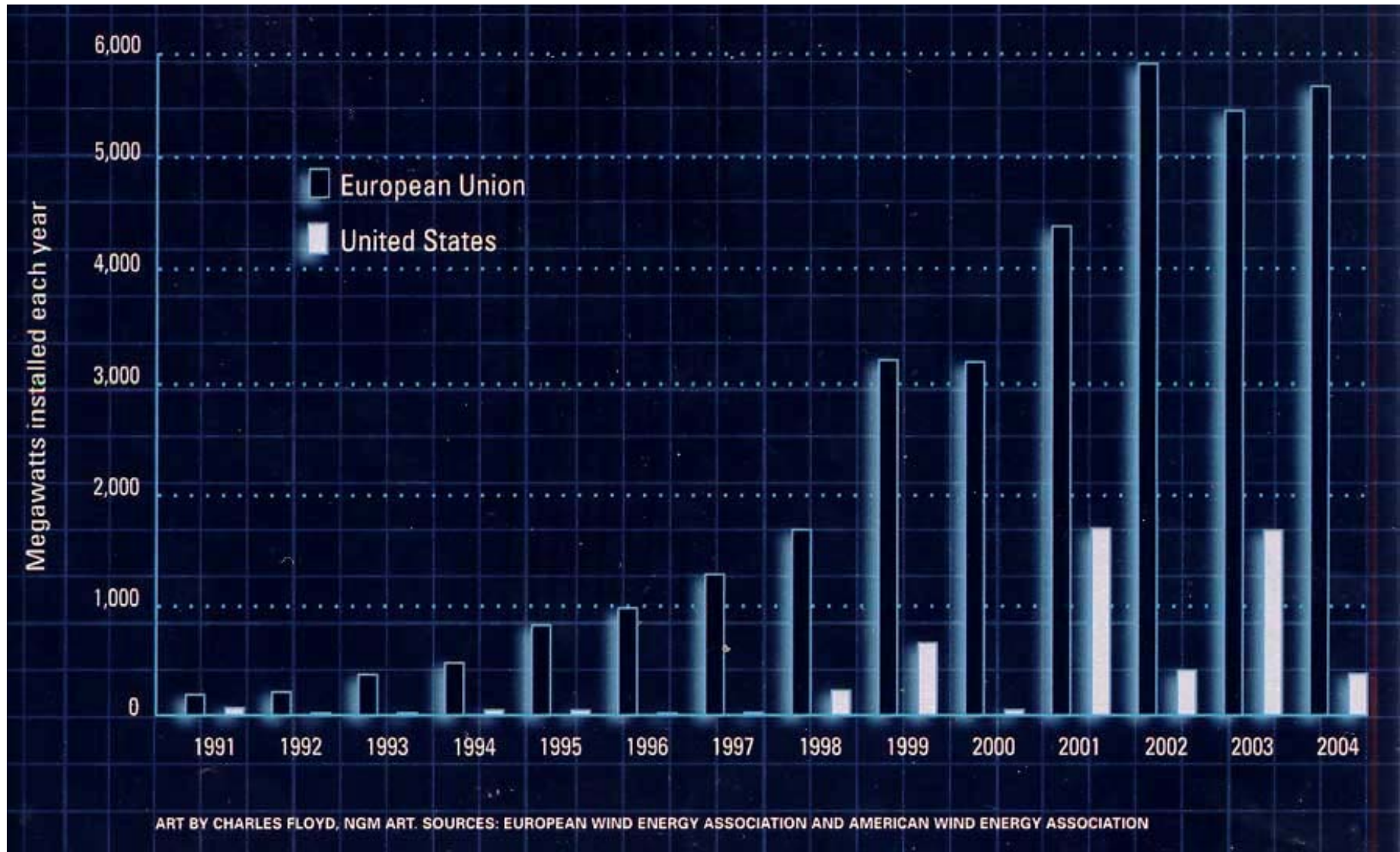

Ontario Wind Farm Projects

Ontario's first large wind farm expected to be operating by next April

By Mary Baxter
For The OCNews

Infrastructure work to support Ontario's first large wind farm is underway on the shores of Lake Erie.

Once complete, the Erie Shores Wind Farm will occupy nearly 30 kilometres along the great lake's shoreline and add 99 megawatts (mw) to the province's power supply.

Bob Livet, vice-president for energy operations with AMEC, said the goal is to have the farm complete by April 2006.

AMEC is an international energy project management company that designs and builds supports for power technologies ranging from hydro, thermal biomass, gas-fired and coal-fired generators to wind technology. In terms of wind, the company has "done quite a bit in the UK," Livet said, noting there that it acts not just as a contractor and designer but also as a developer.

In Canada, the company is working in partnership with Black & McDonald, a private, Canadian-based contractor, in the construction of infrastructure for the Lake Erie project.

The \$186 million project is owned by the Clean Power Income Fund and is developed and will be managed by the privately

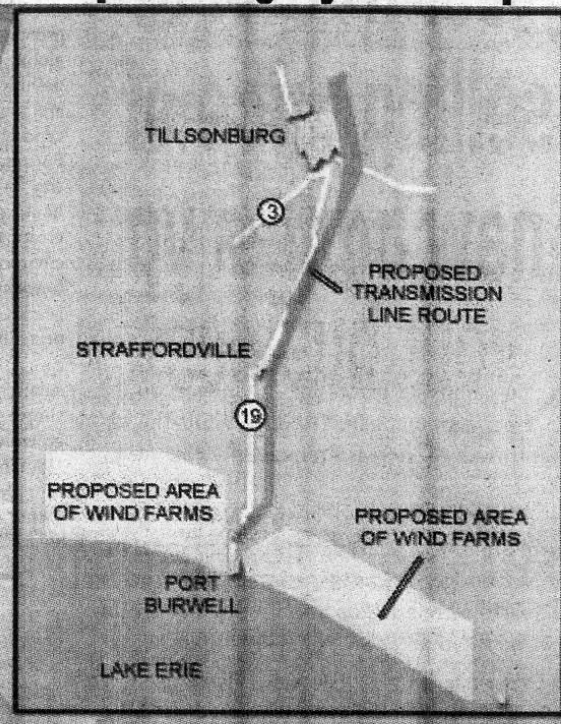
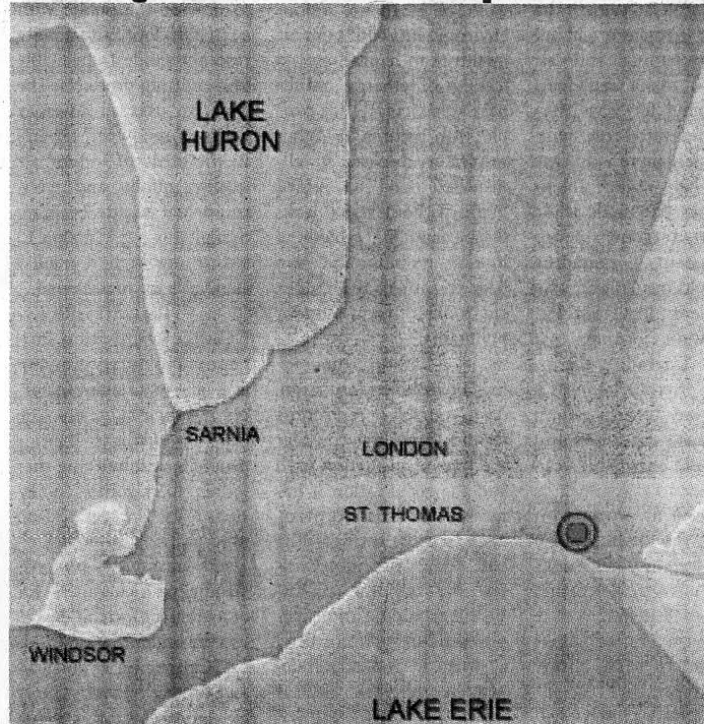

ahead as the Erie Shores one, he said.

That project is also anticipated to be complete early in 2006, he added.

At Erie Shores the large area the farm occupies poses one of the major construction challenges.

"It's something you work through," Livet said pointing out that establishing infrastructure for 66 wind turbines isn't like erecting a self-contained site.

It means having to pay extra attention to how

contacted but also municipalities and counties. (The project straddles two counties and a number of townships).

"They all have their own approval processes for allowances and road ways," Livet said.

Otherwise, construction of the infrastructure is routine, he said other than encountering the usual challenges to do with the lay of the land.

The project involves building access roads, foundations for the

there are only a handful of the 600 to 800 tonne cranes around and the company will have to source them from either the U.S. or Germany.

The cranes' operators, however, come from within the province, he said. The work also involves some local subcontracts for materials like gravel, concrete and reinforced steel. Indeed, Livet said more than five million cubic metres of concrete are needed for the infrastructure.

"It's a lot of con-

According to the Canadian Wind Energy Association, however this resource is rapidly growing worldwide. Figures on the association's website indicated that globally wind accounted for the production of 39,000 mw in 2004 and is projected to supply 95,000 mw by 2008. Livet said the 1.5 mw turbines have a life span of about 20 years.

Later this year, the province will announce the awarding of more approvals for green energy projects following a request for pro-

sometime in the fall.

In July, the ministry also issued a request for proposals for 200 mw of green energy from small to medium-sized projects that would generate no more than 20 mw.

The RFPs are part of the provincial plan to generate five per cent of its energy from renewable resources by 2007 and 10 per cent by 2010.

Livet said his company is working with developers on other proposals in the province. While AMEC

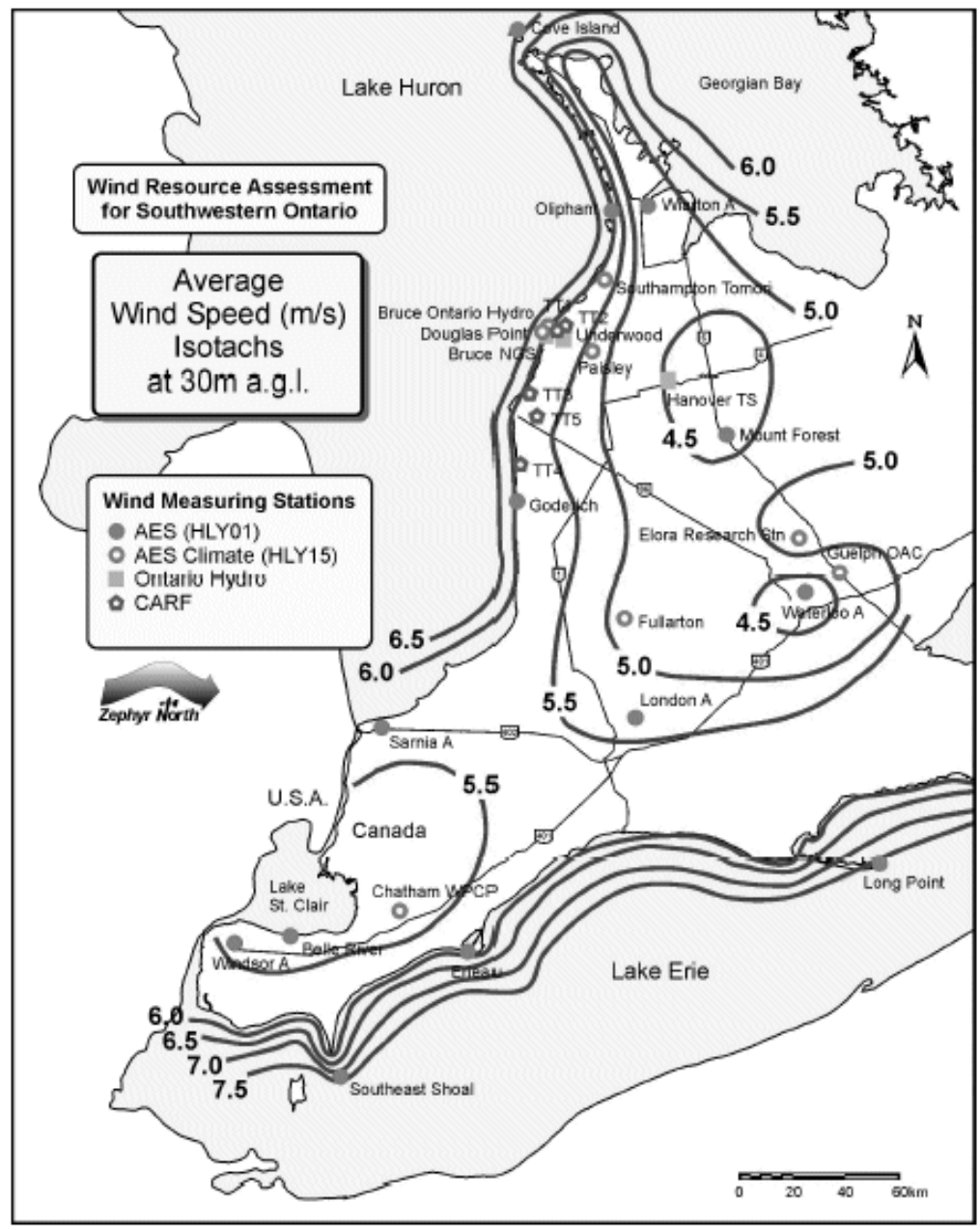
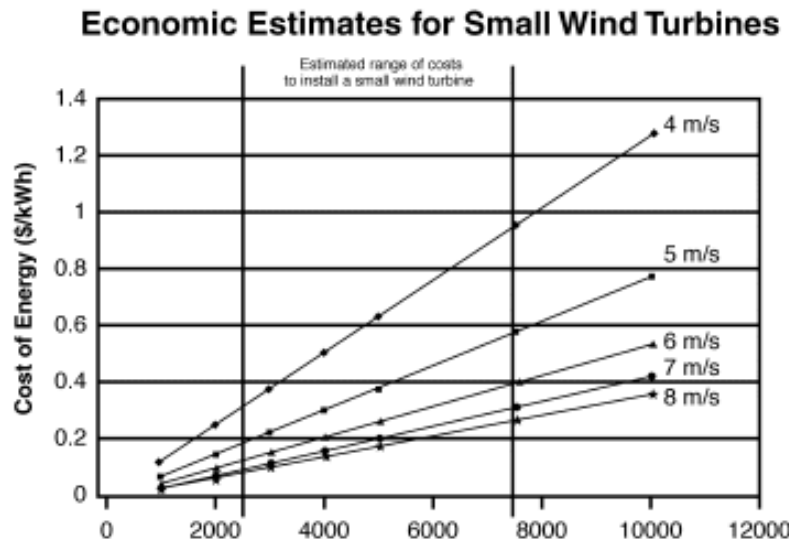
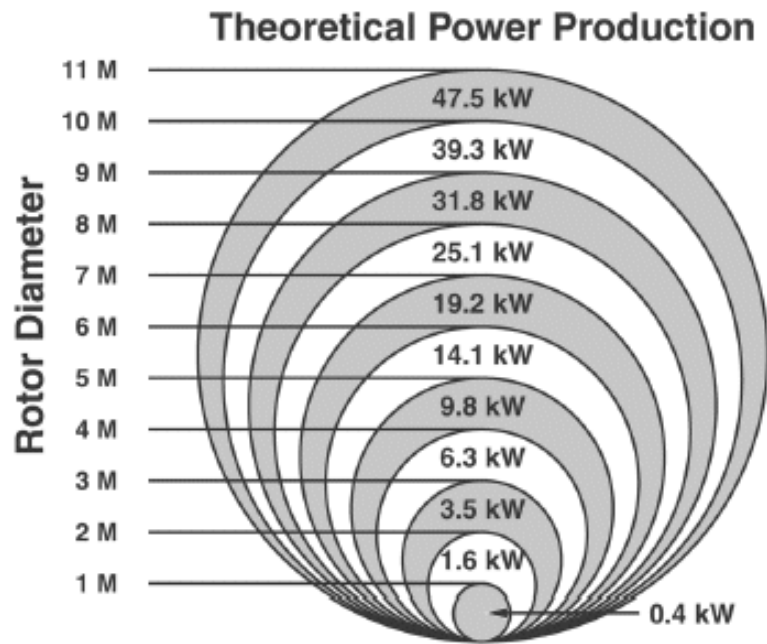

Southern Alberta Wind Farms



Southern Alberta Wind Farms



Southern Alberta Wind Farms



Southern Alberta Wind Farms



How big are they?

1.5 MW turbines, 60 M/300ft high, as proposed for Rookhope

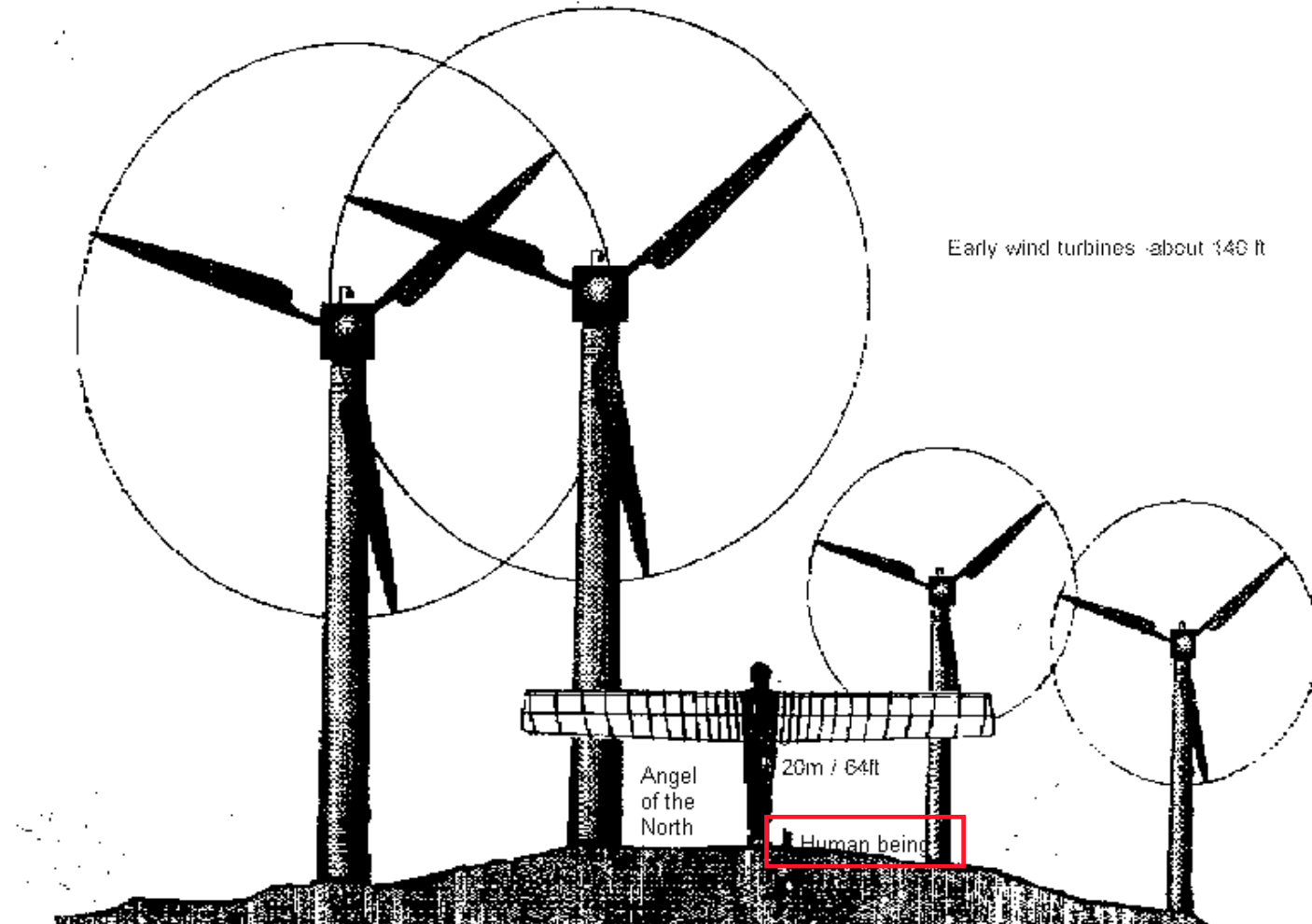

Toronto Wind Turbine



- This unit is a 750 kW, direct drive, model LW 52 wind turbine
- The wind turbine is 94 metres high, or roughly 30 storeys
- The turbine will generate an average of 1,400 megawatt hours of power per year, equivalent to the electricity needs of about **250 homes**
- Cost = \$1.3 million

Kortright Centre Wind Turbines



Constructing a wind turbine

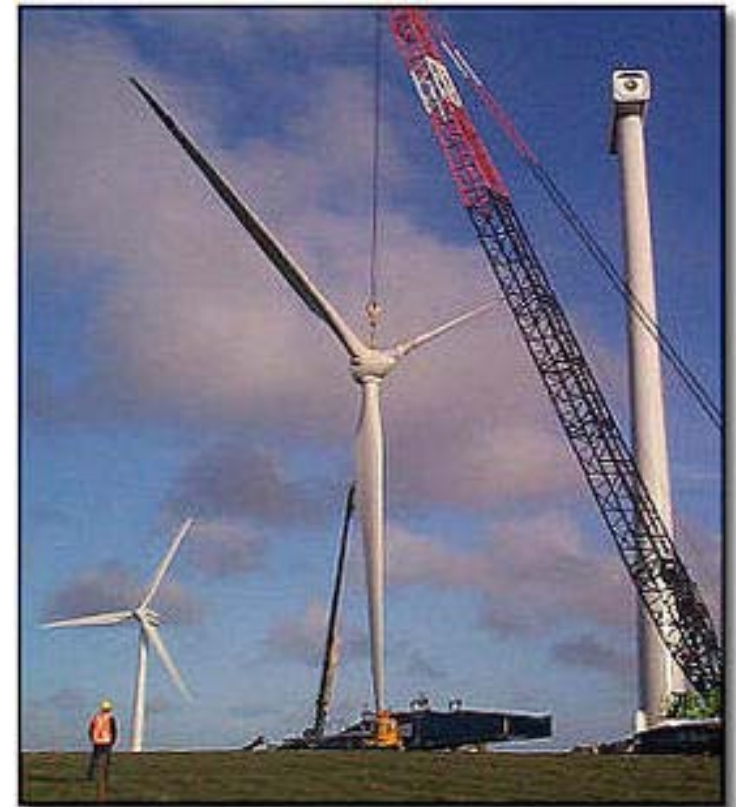





Once famous for quaint hilltop windmills, Denmark is now known for giants like these at the Horns Rev wind farm, where a technician drops in for a checkup. In Denmark wind generates about 20 percent of all electricity. Globally, wind supplies less than one percent of electric power, but it's the fastest growing source.

Wind Resistance

The NIMBY issue.



Home & Marine Wind Machines



<http://www.windenergy.com/>

Building Integrated Wind Turbines



www.hybridynepower.ca





<http://www.bergey.com/>

Building Integrated Wind - Bahrain



http://www.e-architect.co.uk/bahrain/bahrain_wtc_wind_turbines.htm

Building Integrated Wind - Bahrain



http://www.e-architect.co.uk/bahrain/bahrain_wtc_wind_turbines.htm

Strata Building - London

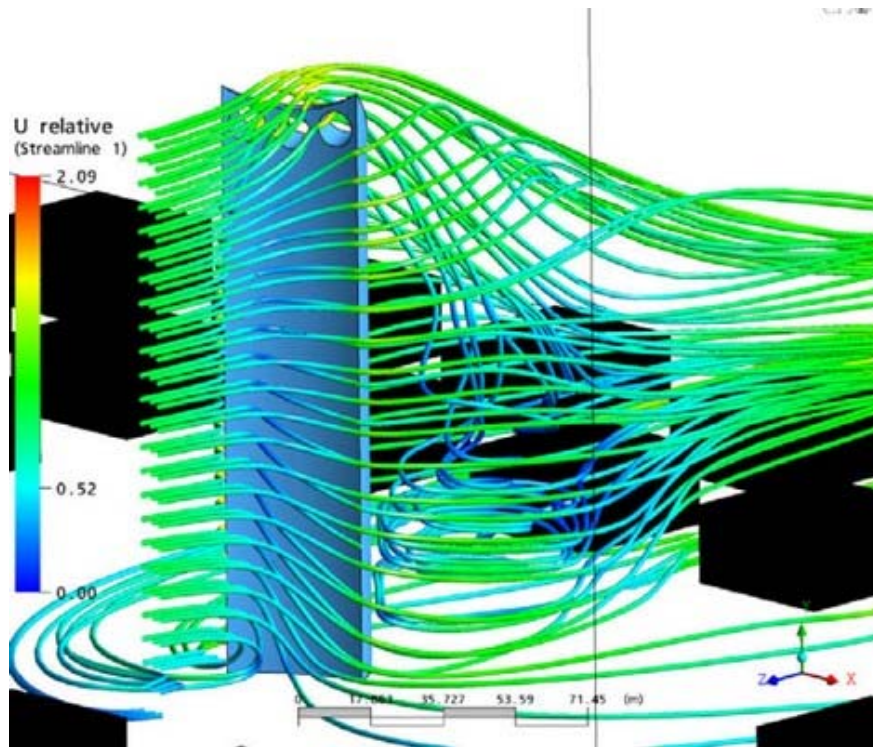

Strata Building - London



Pearl River Tower - Guangzhou

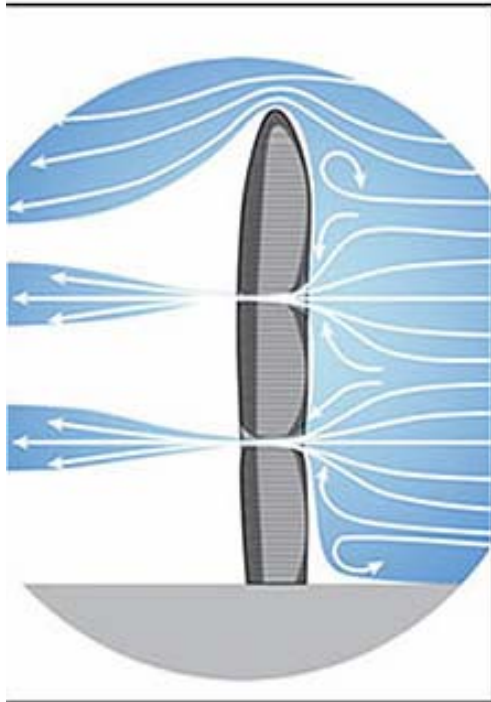

The tower design by SOM channels the wind through slots in the building and vertical turbines.

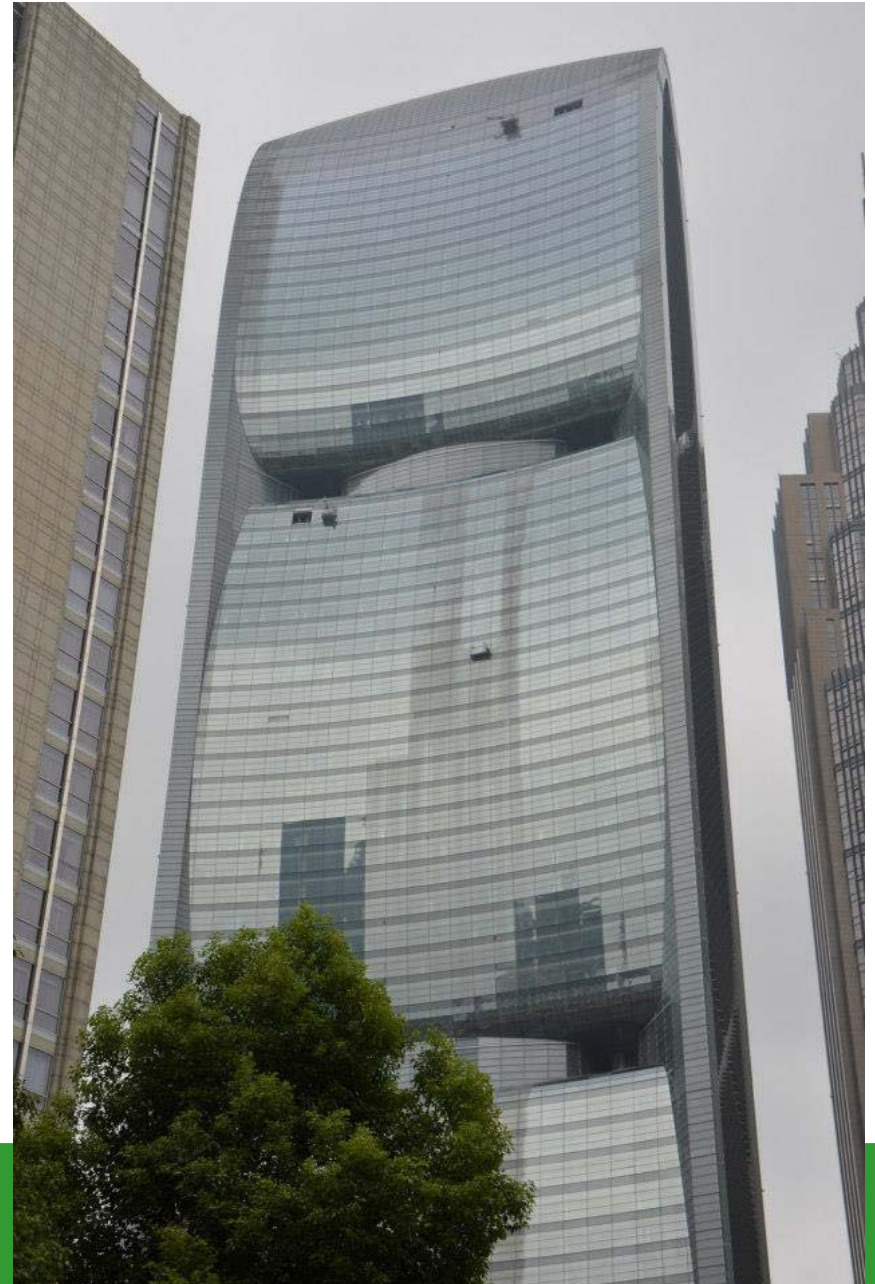

Pearl River Tower - Guangzhou



Pearl River Tower - Guangzhou



Wind dreams.... Or visions?



<http://inhabitat.com/solar-wind-turbine-bridge-repurposes-viaduct-for-public-space/>

Wind dreams.... Or visions?



<http://inhabitat.com/tower-of-power-is-a-wind-energy-generating-skyscraper-for-taiwan/>

Wind dreams.... Or visions?



<http://inhabitat.com/tower-of-power-is-a-wind-energy-generating-skyscraper-for-taiwan/>

Wind dreams.... Or visions?

<http://greenliving4live.com/2013/10/taiwan-skyscrapers-facade-covered-in-thousands-of-wind-turbines/>



Wind dreams.... Or visions?

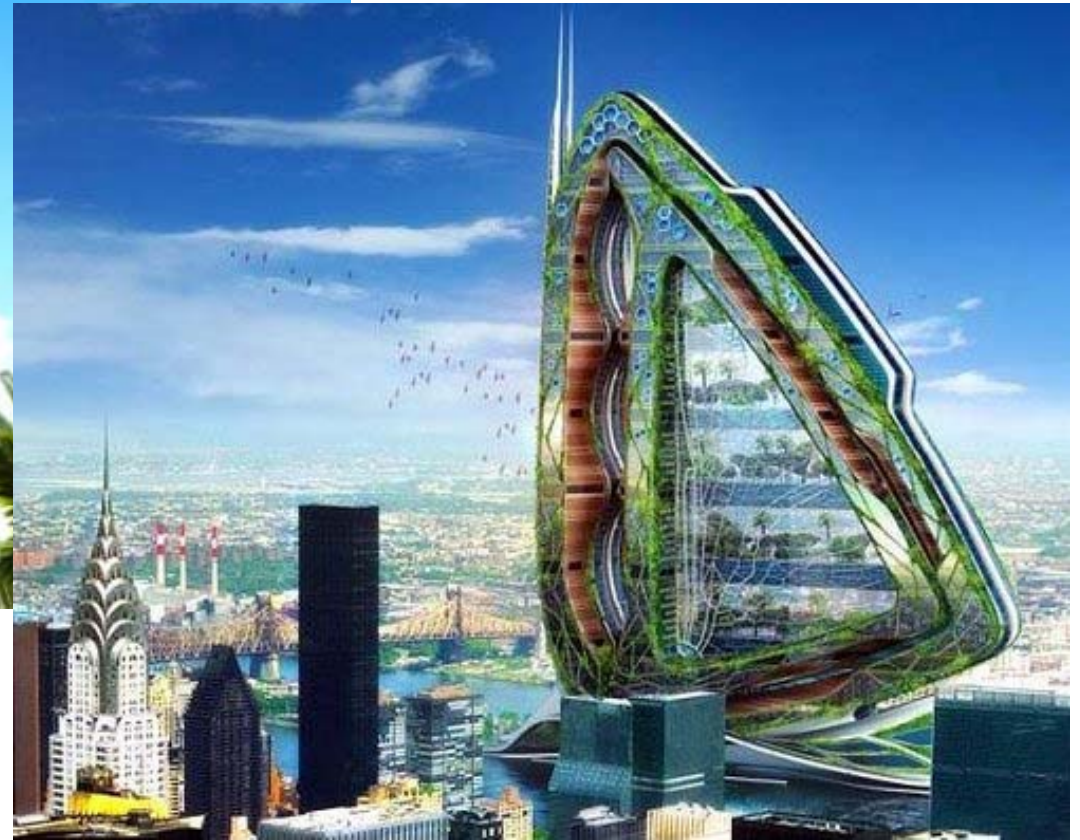

They have come a long way...



Geothermal Systems

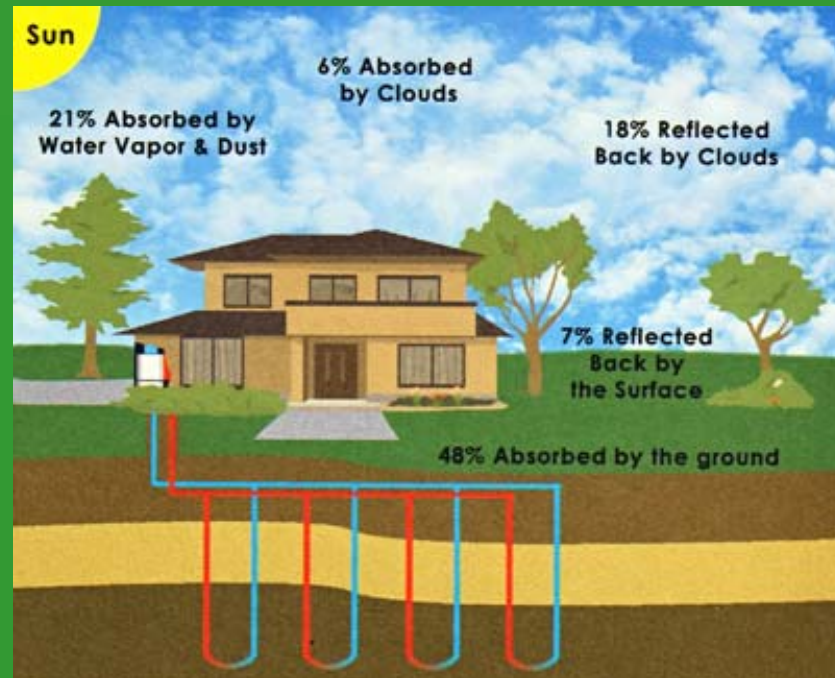

Geothermal components

The characteristics of geothermal systems vary widely, but three components are essential:

- a subsurface heat source
- fluid to transport the heat
- faults, fractures or permeability within subsurface rocks that allow the heated fluid to flow from the heat source to the surface

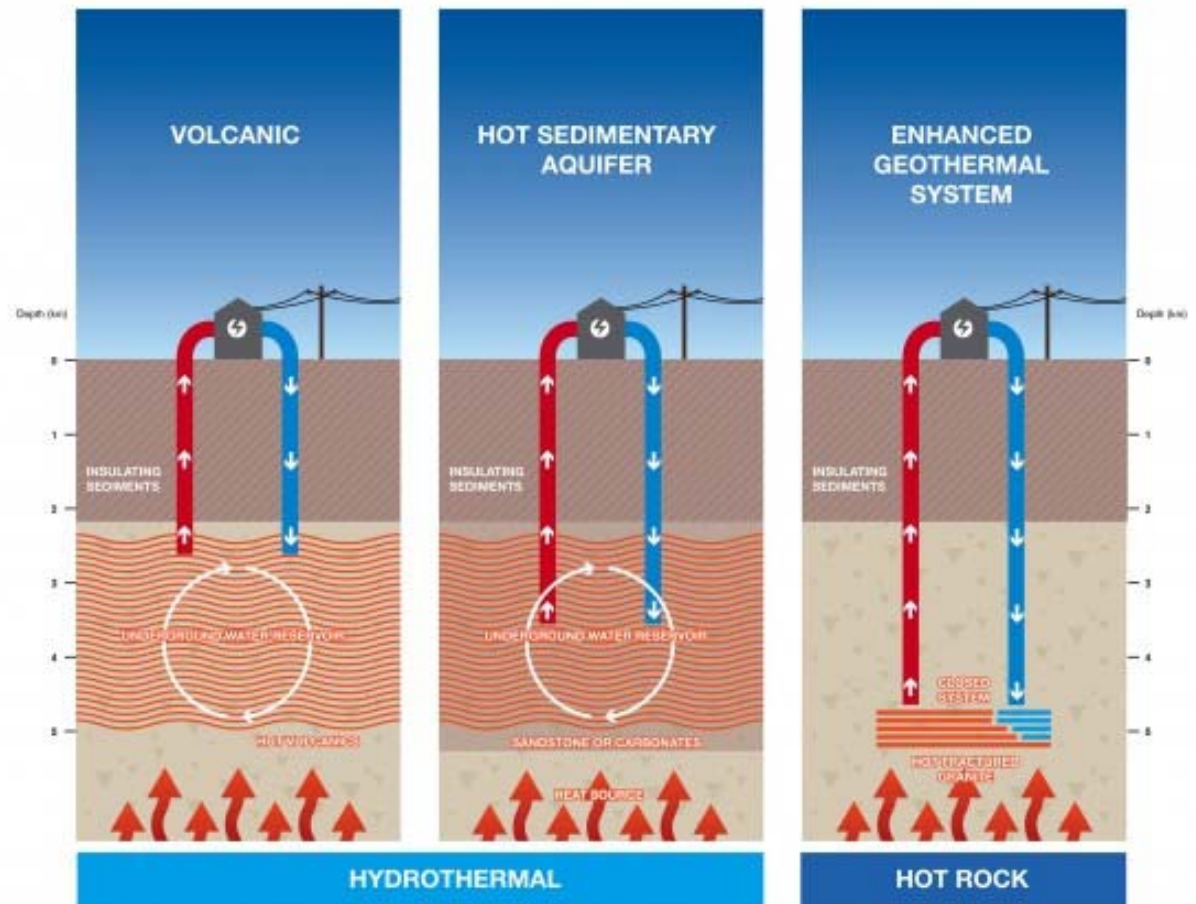

Geothermal Systems: Earth Energy Systems

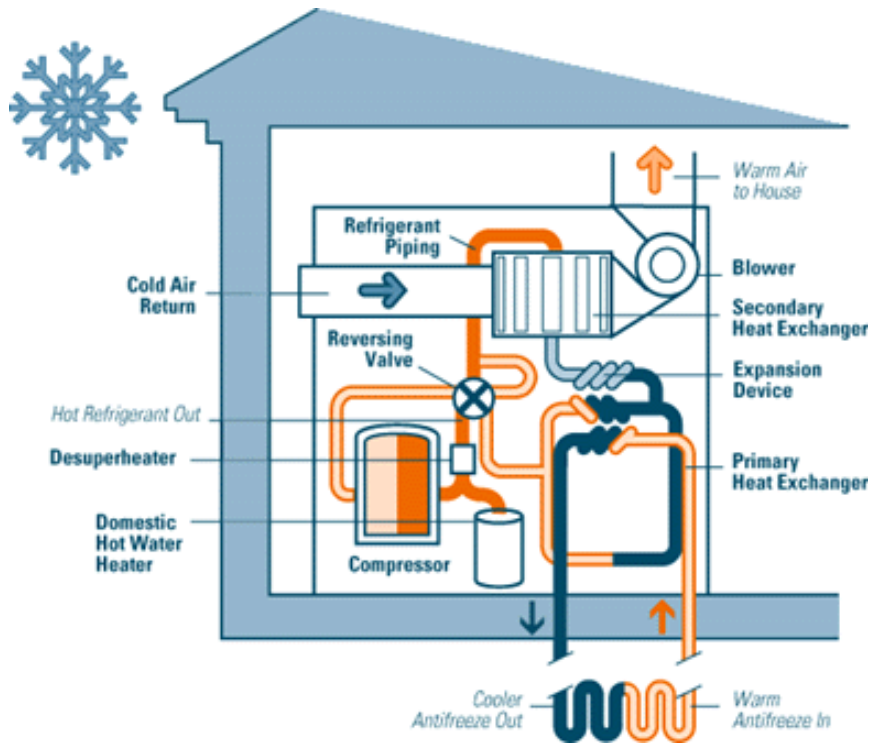

A ground-source heat pump uses the earth or ground water or both as the sources of heat in the winter, and as the "sink" for heat removed from the home in the summer.

For this reason, ground-source heat pump systems have come to be known as earth-energy systems (EESs).

Heat is removed from the earth through a liquid, such as ground water or an antifreeze solution, upgraded by the heat pump, and transferred to indoor air.

During summer months, the process is reversed: heat is extracted from indoor air and transferred to the earth through the ground water or antifreeze solution. A direct-expansion (DX) earth-energy system uses refrigerant in the ground-heat exchanger, instead of an antifreeze solution.

Tapping the underground

Geothermal heat pumps use stable ground temperatures for home heating and cooling. According to the EPA, the geothermal systems can save 40 percent to 70 percent on home-heating and 20 percent to 50 percent on home-cooling costs over conventional systems, although installation costs can be up to \$12,000.

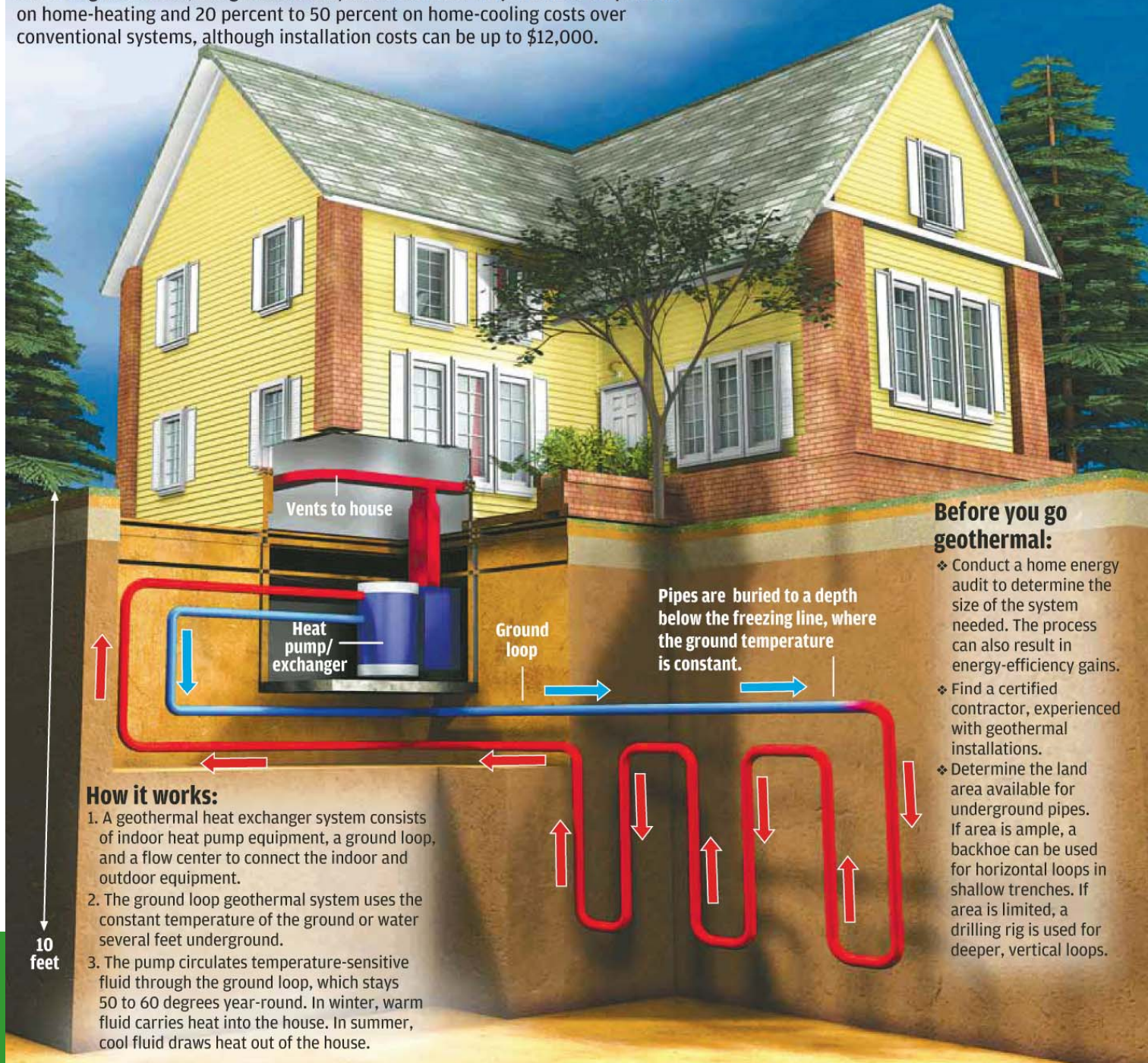

Geothermal Heating System

400% efficient

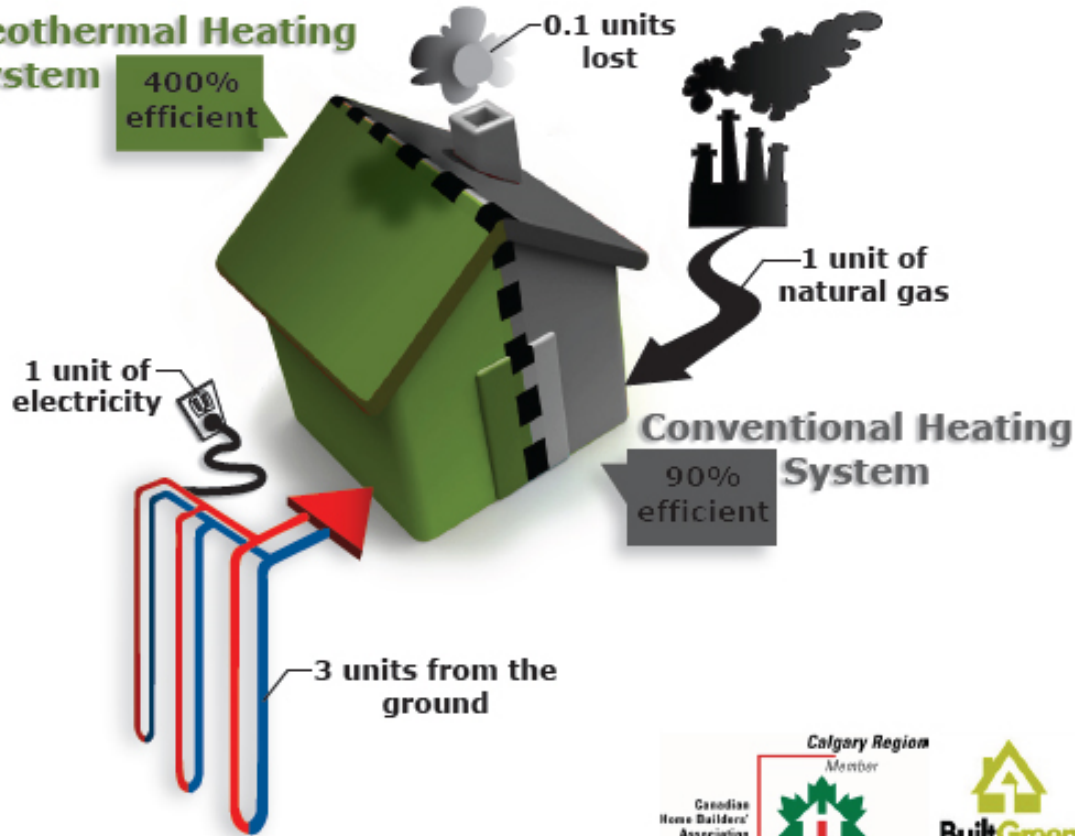

ANNUAL OPERATING COST EXAMPLE

NORTHERN CLIMATE

Based on fuel rates of:

\$0.07/kWhr electric

\$1.50/cf natural gas

\$1.75/gallon propane & fuel oil

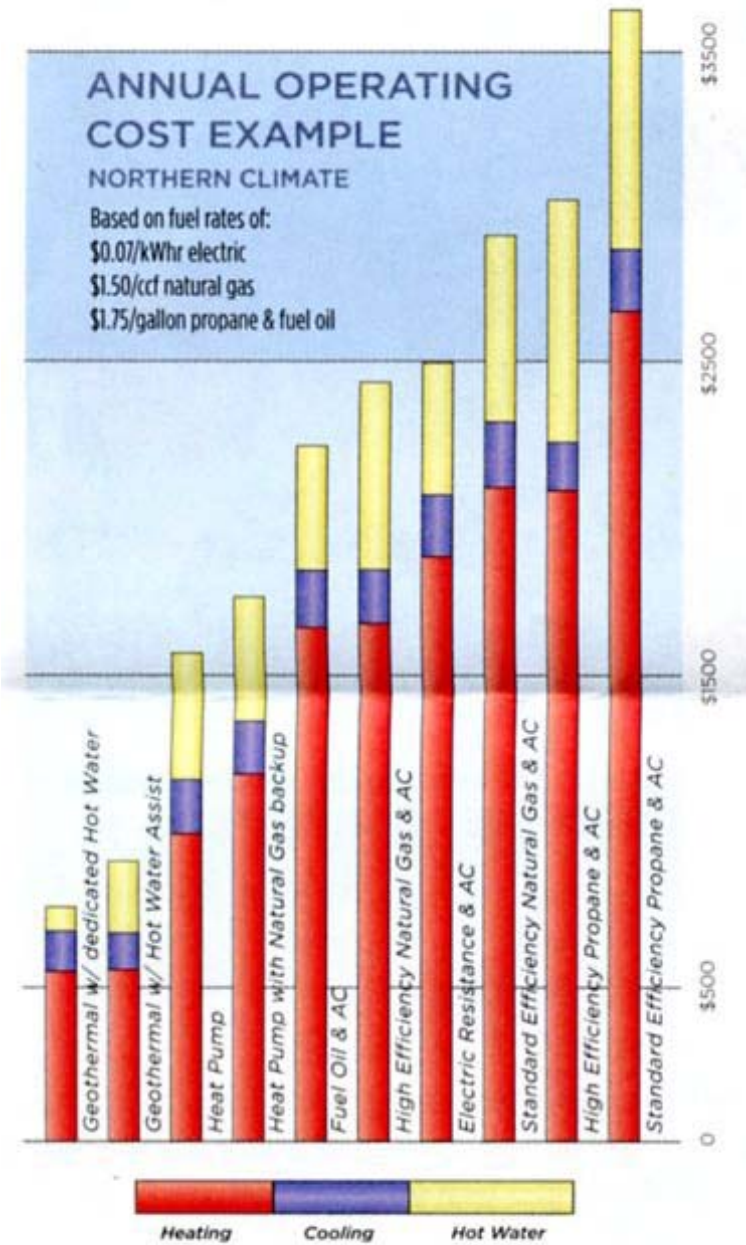

Open Systems:

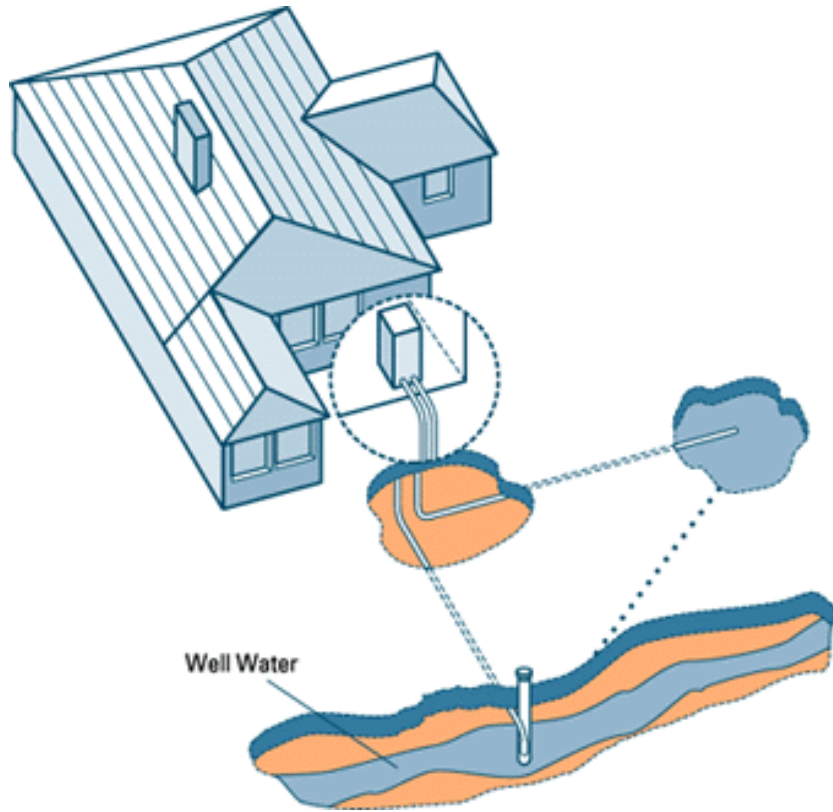

Poor water quality can cause serious problems in open systems. You should not use water from a spring, pond, river, or lake as a source for your heat pump system unless it has been proven to be free of excessive particles and organic matter, and warm enough throughout the year (typically over 5° C) to avoid freeze-up of the heat exchanger.

As noted, an open system uses ground water from a conventional well as a heat source. The ground water is pumped into the heat pump unit, where heat is extracted. Then, the "used" water is released in a stream, pond, ditch, drainage tile, river, or lake. This process is often referred to as the "open discharge" method. (This may not be acceptable in your area. Check with local authorities.)

Open System Using Ground Water from a Well

Closed Systems:

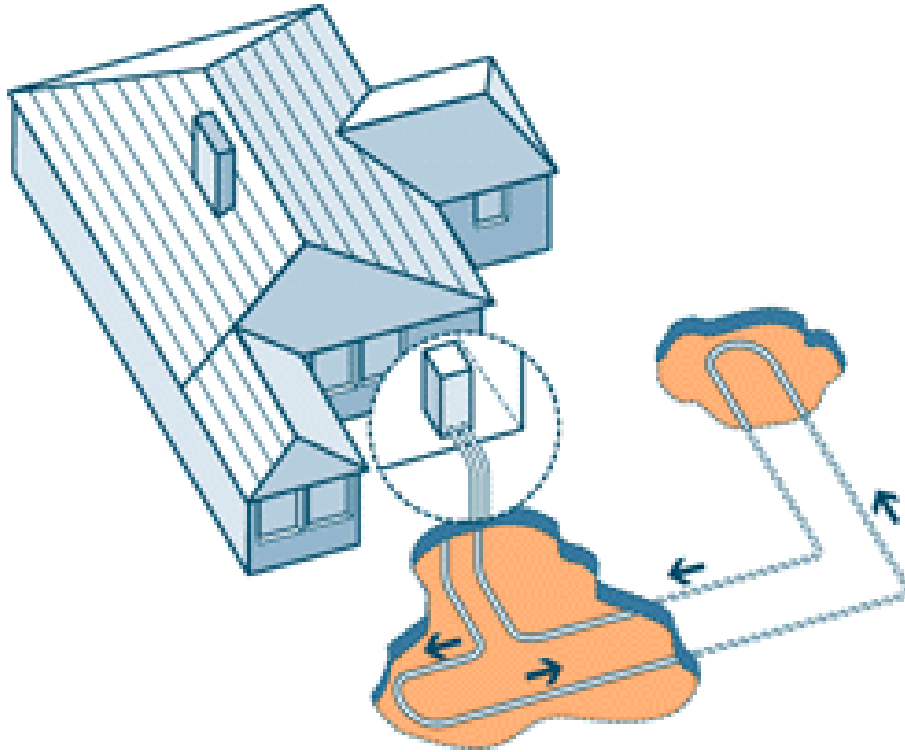

Closed-Loop, Single Layer Horizontal Configuration

A closed-loop system draws heat from the ground itself, using a continuous loop of special buried plastic pipe. Copper tubing is used in the case of DX systems. The pipe is connected to the indoor heat pump to form a sealed underground loop through which an antifreeze solution or refrigerant is circulated. While an open system drains water from a well, a closed-loop system re-circulates its heat transfer solution in pressurized pipe.

Closed Systems:

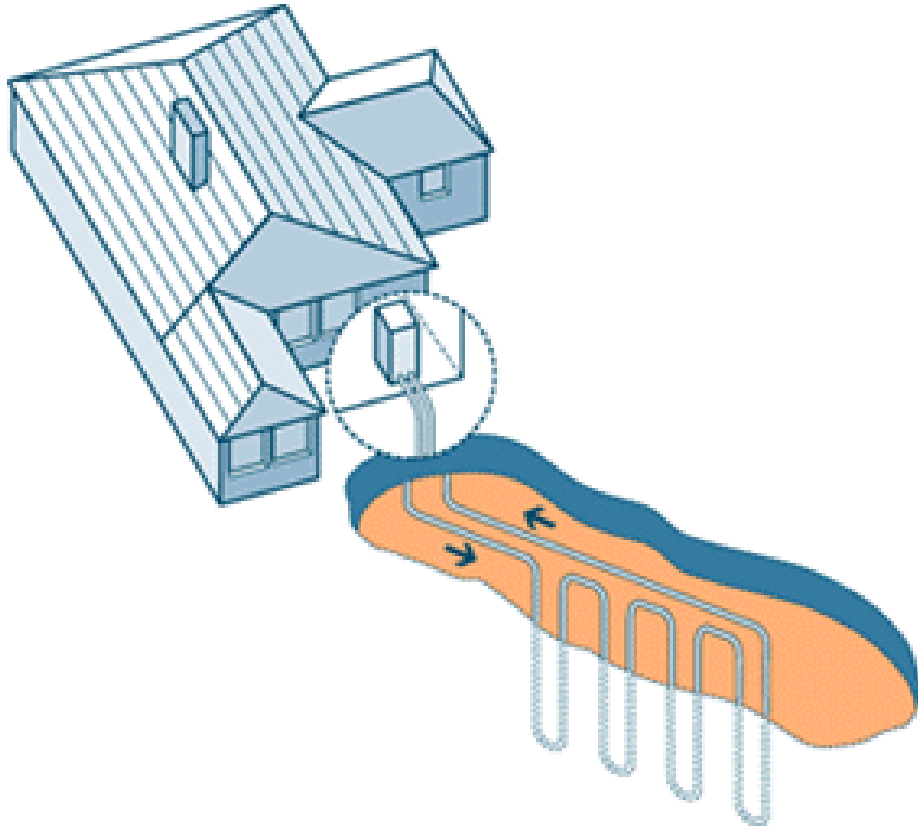

All piping for antifreeze solution systems must be at least series 100 polyethylene or polybutylene with thermally fused joints (as opposed to barbed fittings, clamps, or glued joints), to ensure leak-free connections for the life of the piping. Properly installed, these pipes will last anywhere from 25 to 75 years. They are unaffected by chemicals found in soil and have good heat-conducting properties. The antifreeze solution must be acceptable to local environmental officials. DX systems use a refrigeration-grade copper tubing.

Closed-Loop, Single U-bend Vertical Configuration



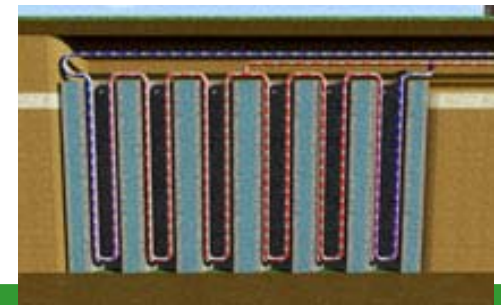
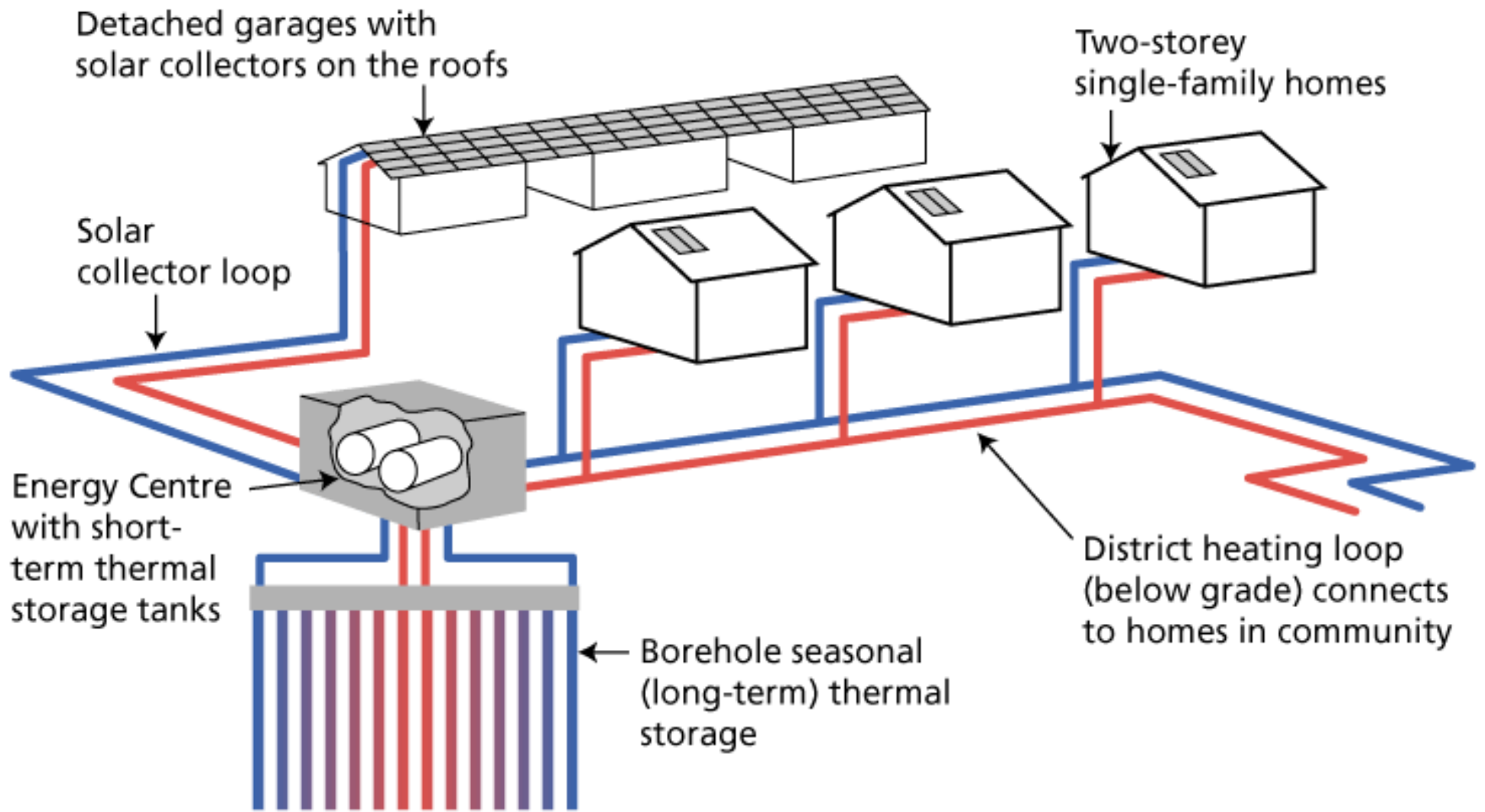

Distribution - Radiant Heating:

A home that requires a cooling system will typically have a separate system installed to provide the cooling. The reason is straightforward: heating is ideally delivered from the ground up.

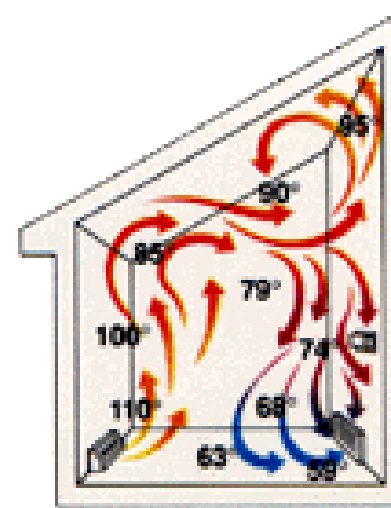
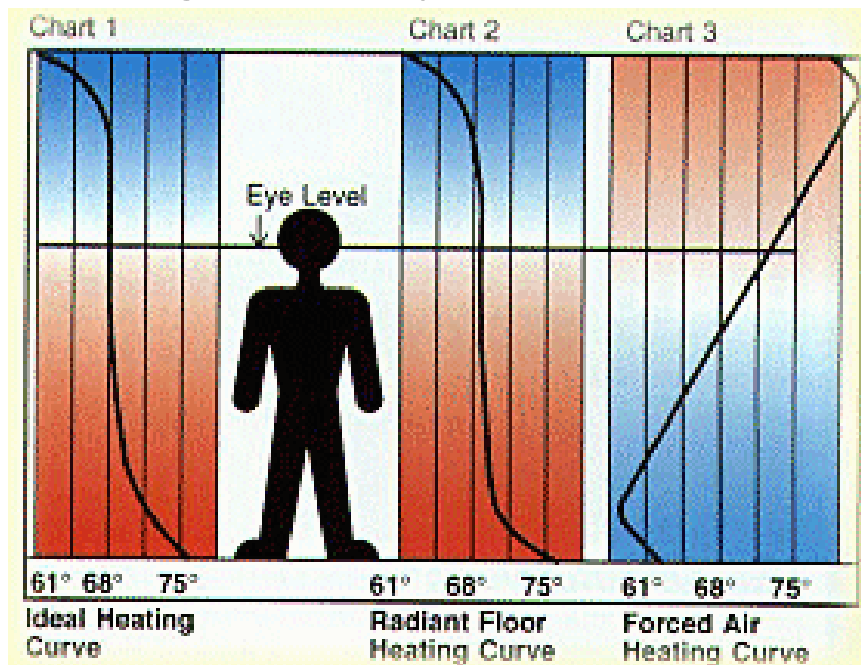

Forced Air

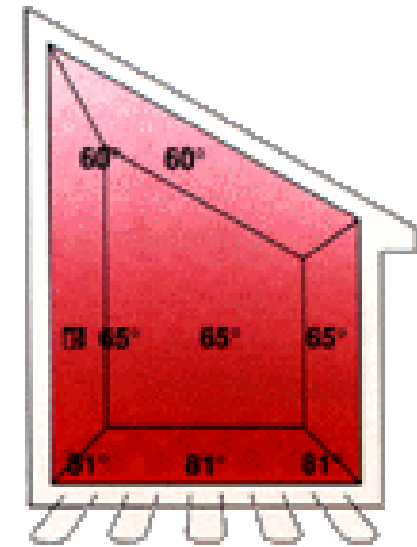

Radiant Floor

Radiant floor heating produces room temperatures very close to ideal: 75° at floor level, declining to 68° at eye level, then to 61° at the ceiling.



Look into radiant
...and what do you see?

Radiant Floor Heating:

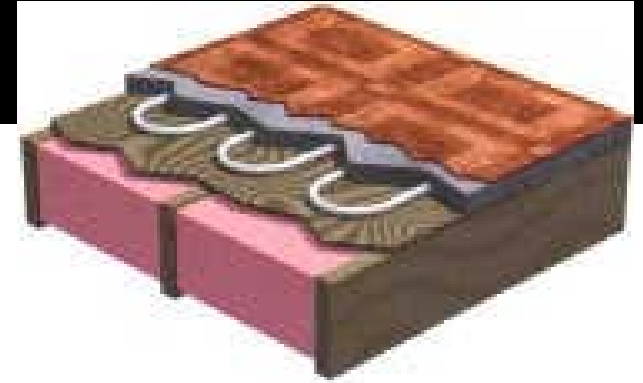

COMPONENTS OF A RADIANT FLOOR HEATING SYSTEM (FOR HYDRONIC SYSTEMS)

Here are the components required for a radiant floor heating system:

- * Heating Source – this can be electricity, solar, natural gas, propane, oil, wood, or any other heating source.
- * Boiler – houses the water to be heated
- * Pump – to circulate the water through tubing located under the floor.
- * Tubing – the water will circulate in tubing running beneath the floor in the concrete, under wood floors, or on a sub floor of wood, precast concrete, or slab-on-grade concrete.



Step 1: The tubing is installed to the sub-floor of the home...



Step 2: The first layer of liquified gypsum covers the tubing...



Step 3: The 2nd layer of liquified gypsum is 'floated' over the 1st layer...



Step 4: The gypsum surface is smoothed to a glass-like finish & left to dry...

Installation in Concrete

Many radiant floor heating projects are in slab-on-grade concrete. Tubing is installed in the slab. Temperature-controlled water then circulates through the tubing in the slabs: this process turns the slab into a radiant panel.

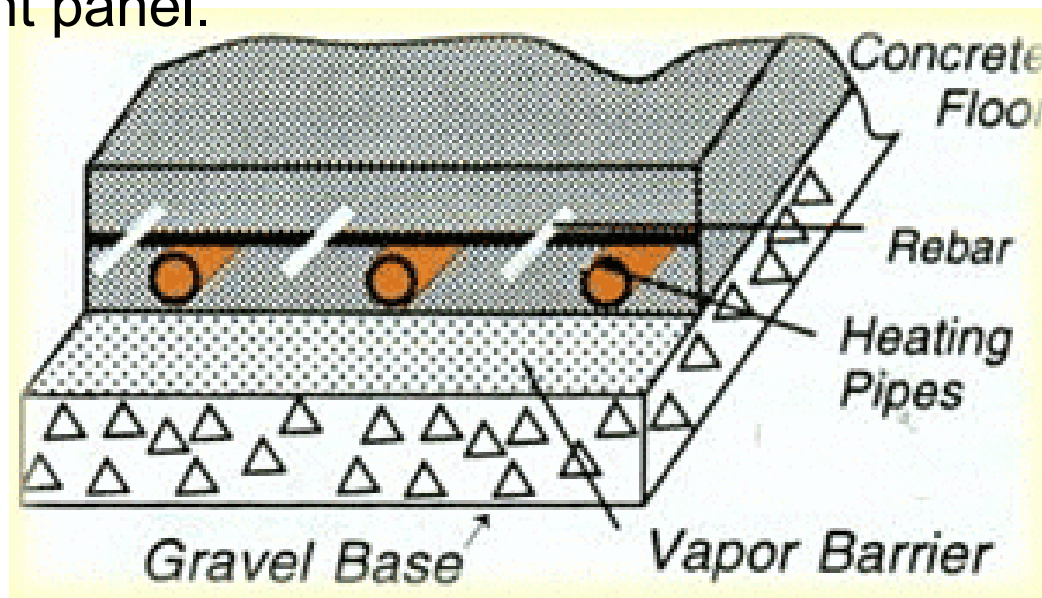

Concrete presents the greatest thermal mass of any of the radiant floor heating methods, which can be a tremendous benefit in rooms or buildings with high ceilings.

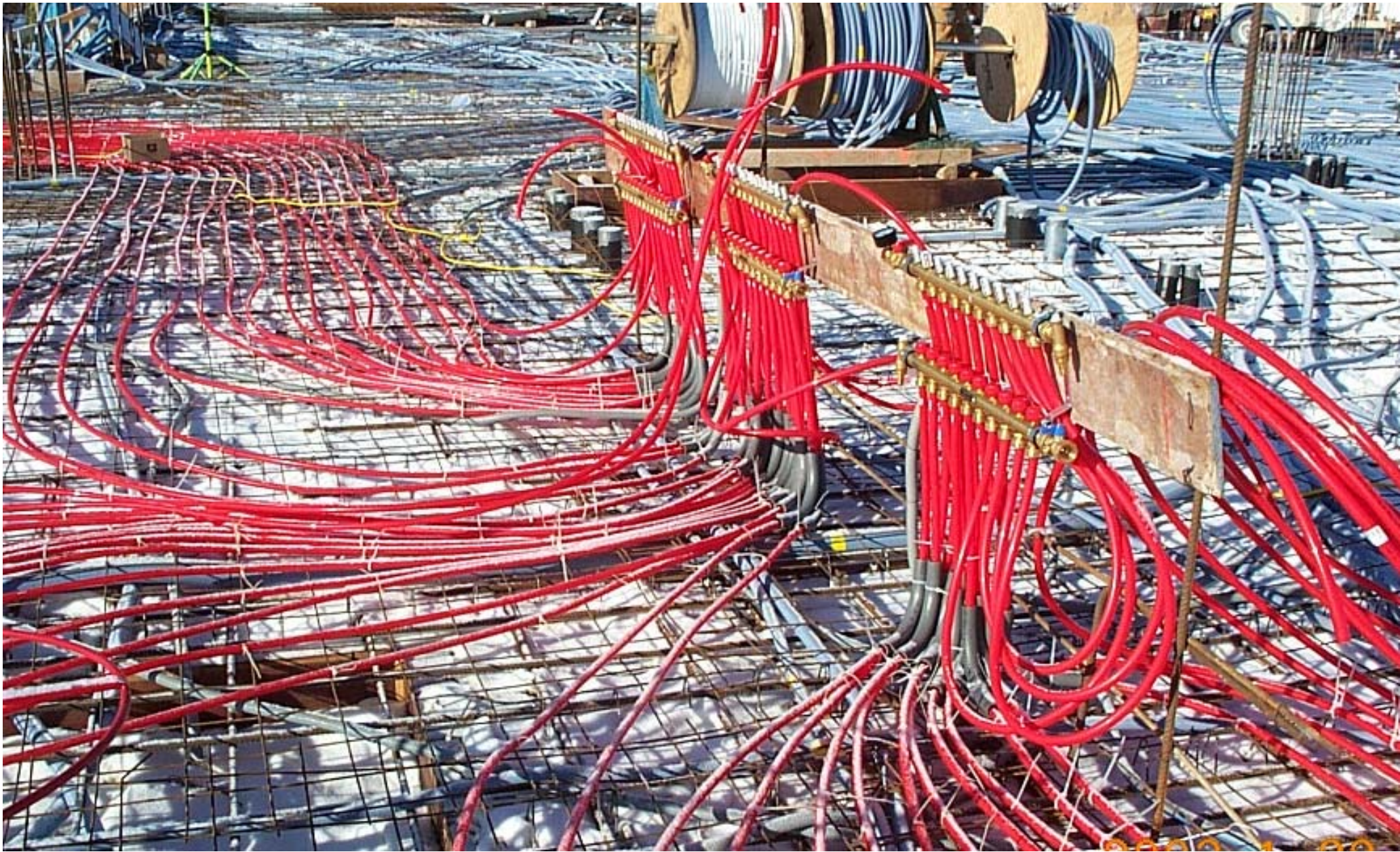



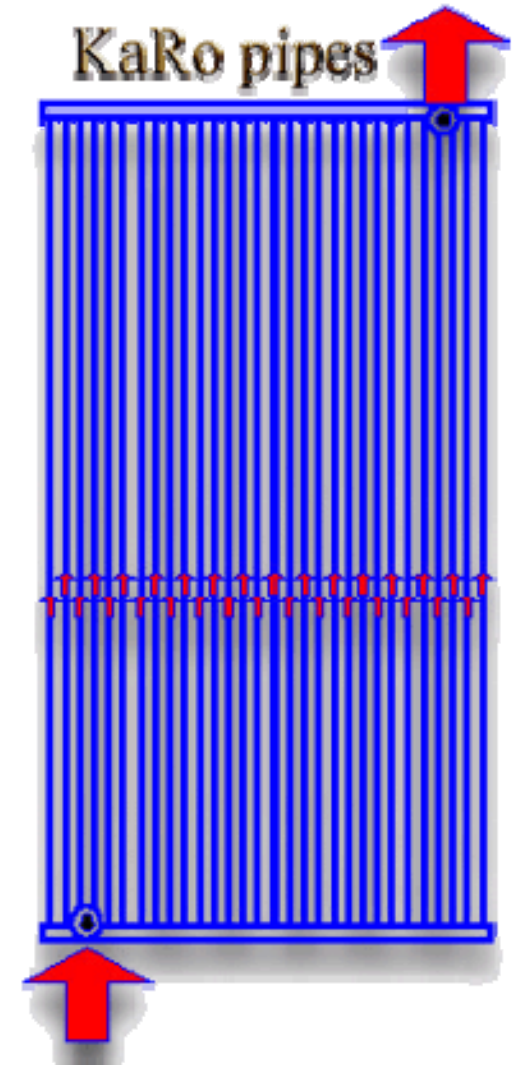
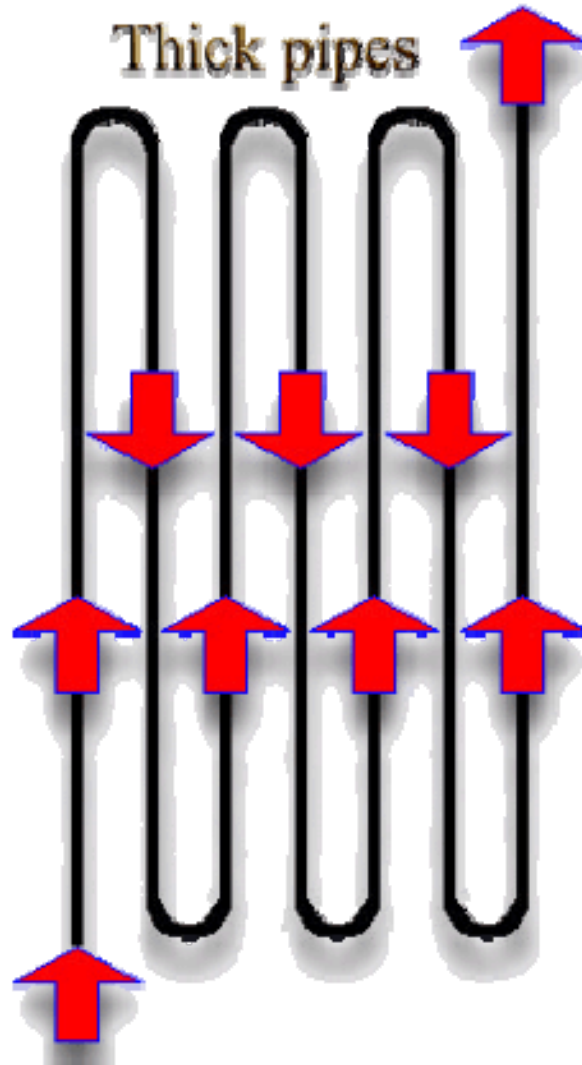
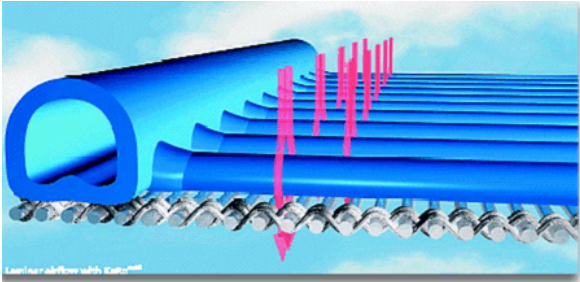

Capillary tube radiant systems

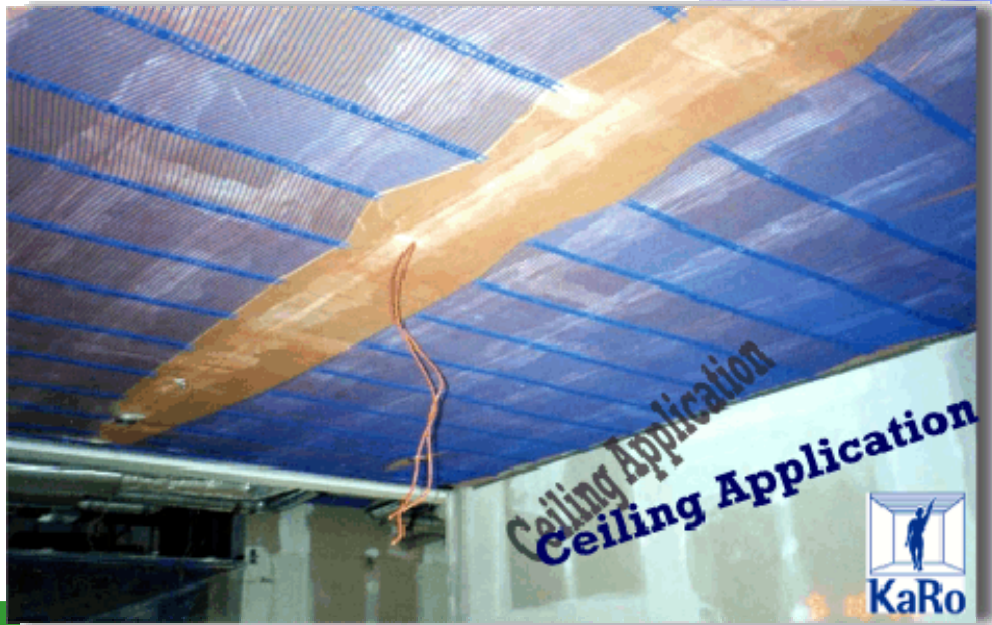
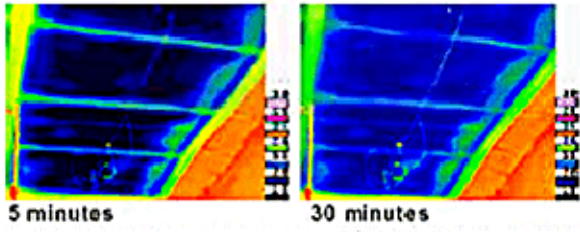
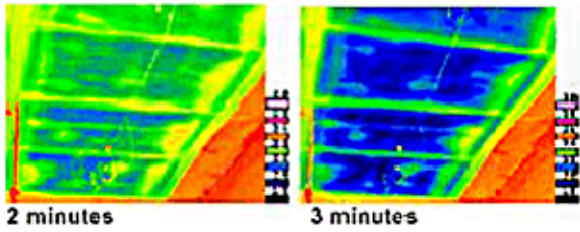
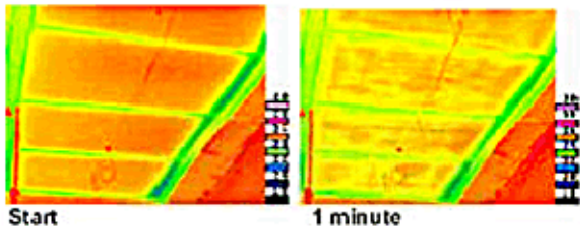

Radiant Delivery Heating & Cooling:

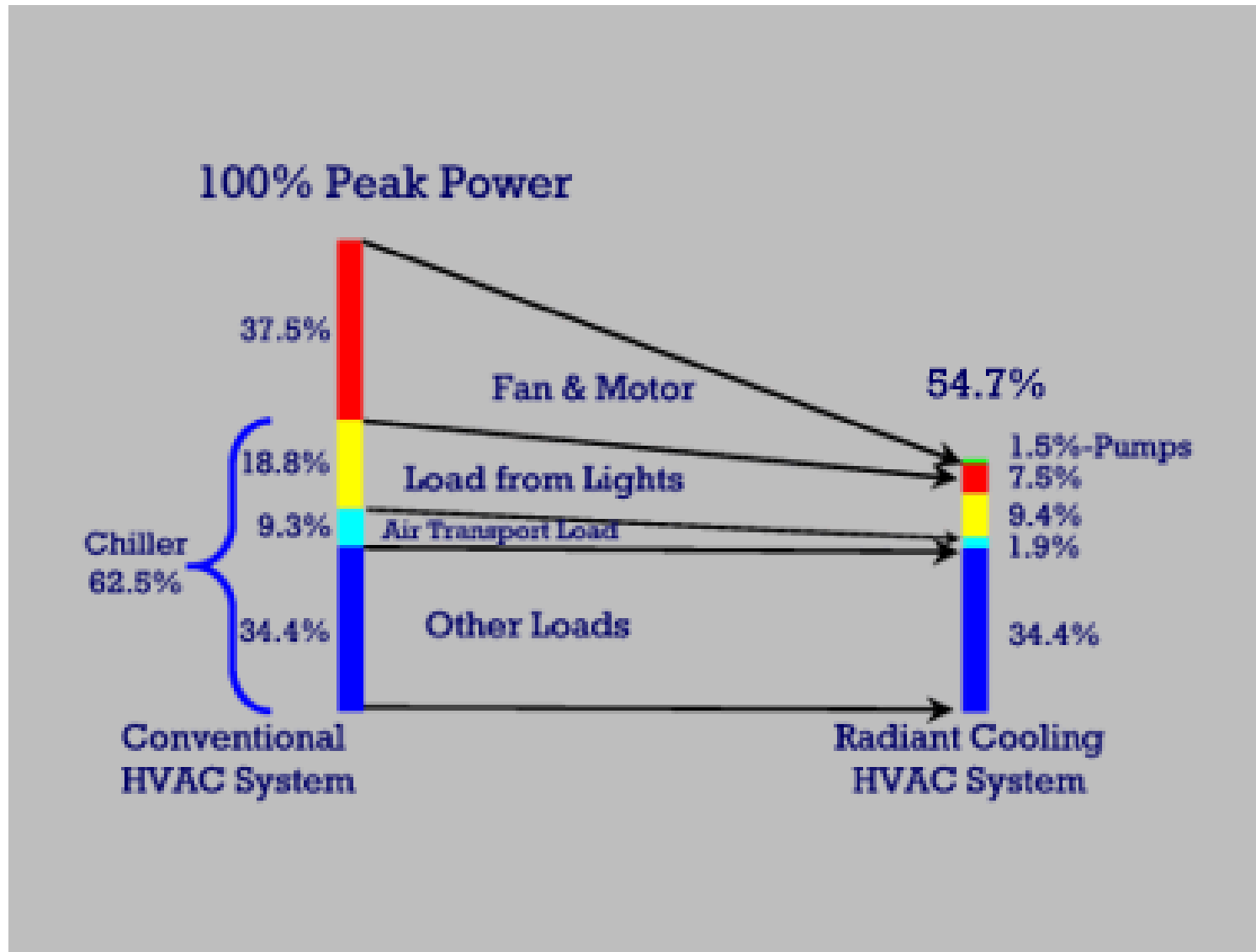

Although ceramic tile is the most common floor covering for radiant floor heating, almost any floor covering can be used. However, some perform better than others. Common floor coverings like vinyl and linoleum sheet goods, carpeting, wood or bare concrete is often specified. However, it is wise to always remember that anything that can insulate the floor also reduces or slows the heat entering the space from the floor system. This in turn increases fuel consumption.

Most radiant floor references also recommend using laminated wood flooring instead of solid wood. This reduces the possibility of the wood shrinking and cracking from the drying effects of the heat.

FLOOR COVERING CAN =
THERMAL MASS

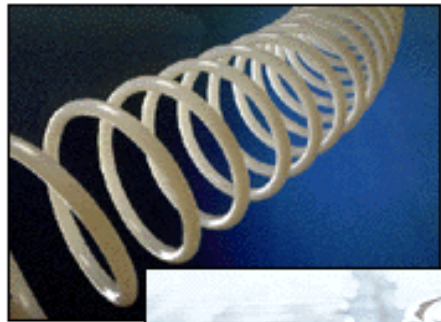

Older radiant floor systems used either copper or steel tubing embedded in the concrete floors. Unless the builder coated the tubing with a protective compound, a chemical reaction between the metal and the concrete often led to corrosion of the tubing, and to eventual leaks.

Major manufacturers of hydronic radiant floor systems now use cross-linked polyethylene (PEX) or rubber tubing with an oxygen diffusion barrier. These materials have proven themselves to be more reliable than the older choices in tubing. Fluid additives also help protect the system from corrosion.

types of tubing

