

# Arch 125: Environmental Building Design

## Passive Solar Design (Heating)





HCL

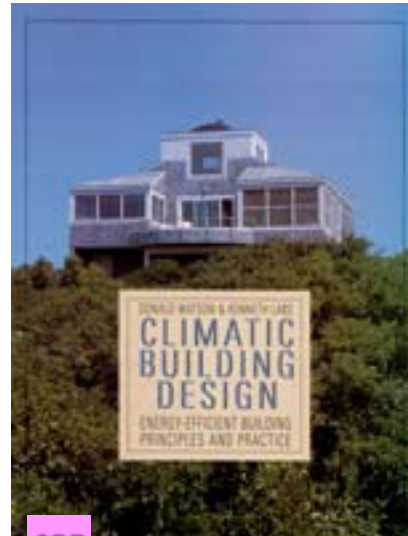

CBD



SWL

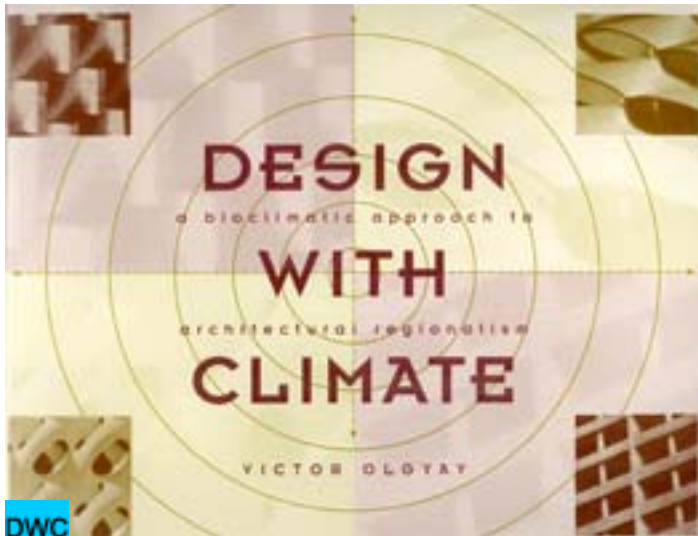

DWC

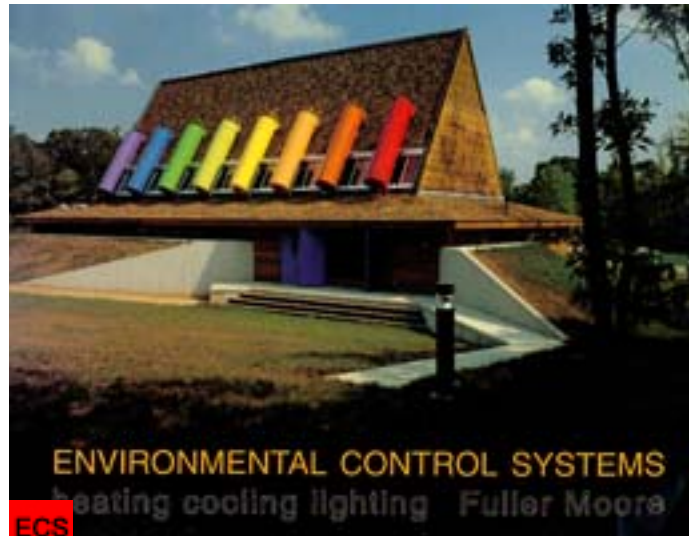

ECS

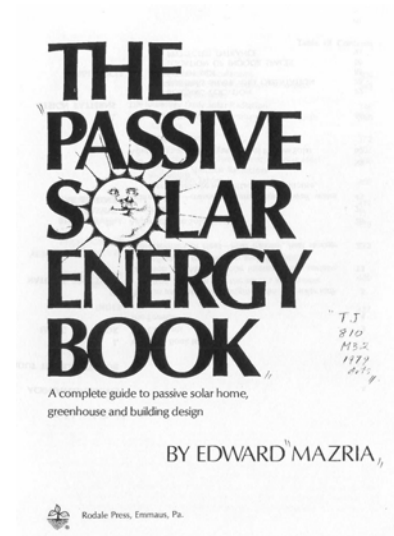

Texts used in the preparation of this presentation.

# What is PASSIVE Design?

- is based upon climate considerations
- attempts to control comfort (heating and cooling) without consuming fuels
- uses the orientation of the building to control heat gain and heat loss
- uses the shape of the building (plan, section) to control air flow
- uses materials to control heat
- maximizes use of free solar energy for heating and lighting
- maximizes use of free ventilation for cooling
- uses shade (natural or architectural) to control heat gain

# How do Passive and Sustainable Design relate?

Passive solar heating and passive ventilation for cooling assist in creating sustainable building by reducing dependency on fossil fuels for heating and cooling buildings, as well as reducing the need for electricity to support lighting by using practices of daylighting in buildings.

In LEED, Passive Design assists in gaining points in the Energy and Atmosphere category, as well as in Indoor Air Quality as Passive Design promotes natural ventilation and daylighting strategies.

However, not all Sustainably Designed buildings are strongly Passive, and not all Passively Designed buildings are by default strongly sustainable (although this is more likely than the reverse.)



# Passive Buildings Require Active Users...

Unlike most contemporarily designed buildings that rely on “Thermostat” control to regulate the temperature and relative humidity (comfort) in buildings, Passive Buildings require occupant involvement to ensure their success.

Occupants need to be EDUCATED as to when to open and close windows, raise and lower shades, and otherwise control some of the non automated means of controlling the effects of the sun and wind on the interior environments of the building.

Sometimes Passive Buildings, due to limitations in achieving an interior climate that falls in the middle of the “comfort zone”, will require occupants to accept a wider range of acceptable temperature and relative humidity values.



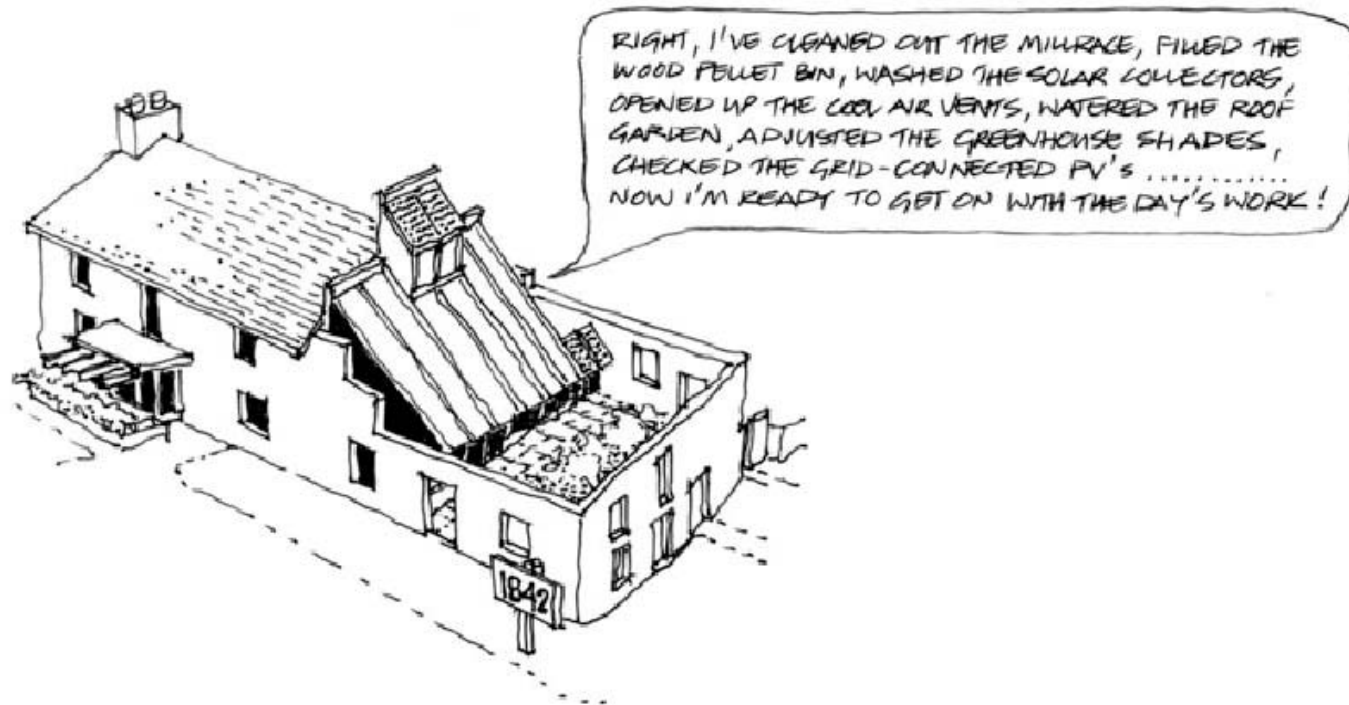

Apologies to Louis Hellman

"RIGHT, I'VE CLEANED OUT THE MILLRACE, FILLED THE WOOD PELLET BIN, WASHED THE SOLAR COLLECTORS, OPENED UP THE COOL AIR VENTS, WATERED THE ROOF GARDEN, ADJUSTED THE GREENHOUSE SHADES, CHECKED THE GRID-CONNECTED PVs..... NOW I'M READY TO GET ON WITH THE DAY'S WORK!"

(Louis Hellman writing about The Mill, Eden Mills home and office of Charles Simon.)

## 6 main strategy modes for PASSIVE design

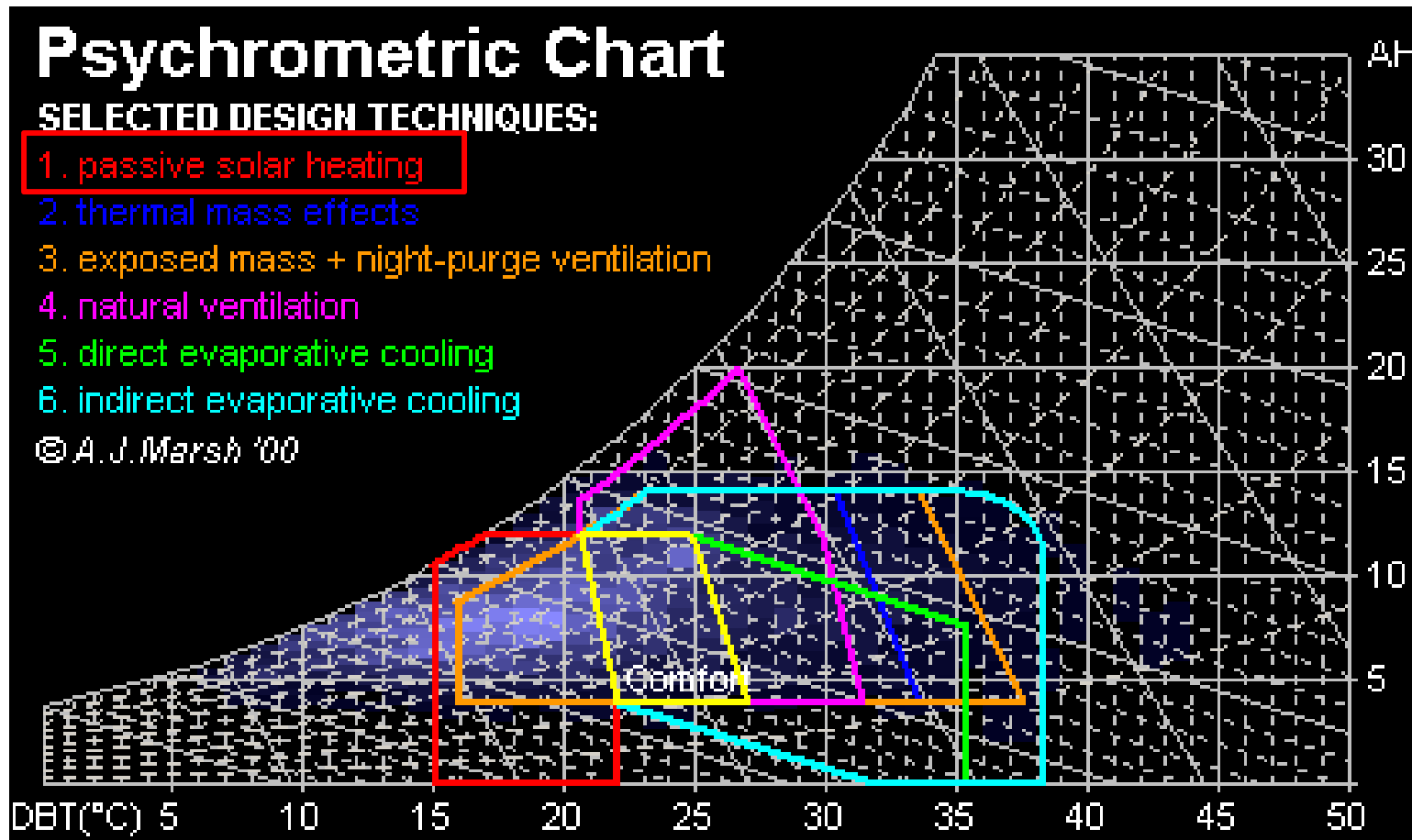

# Olgay: Comfort Zone

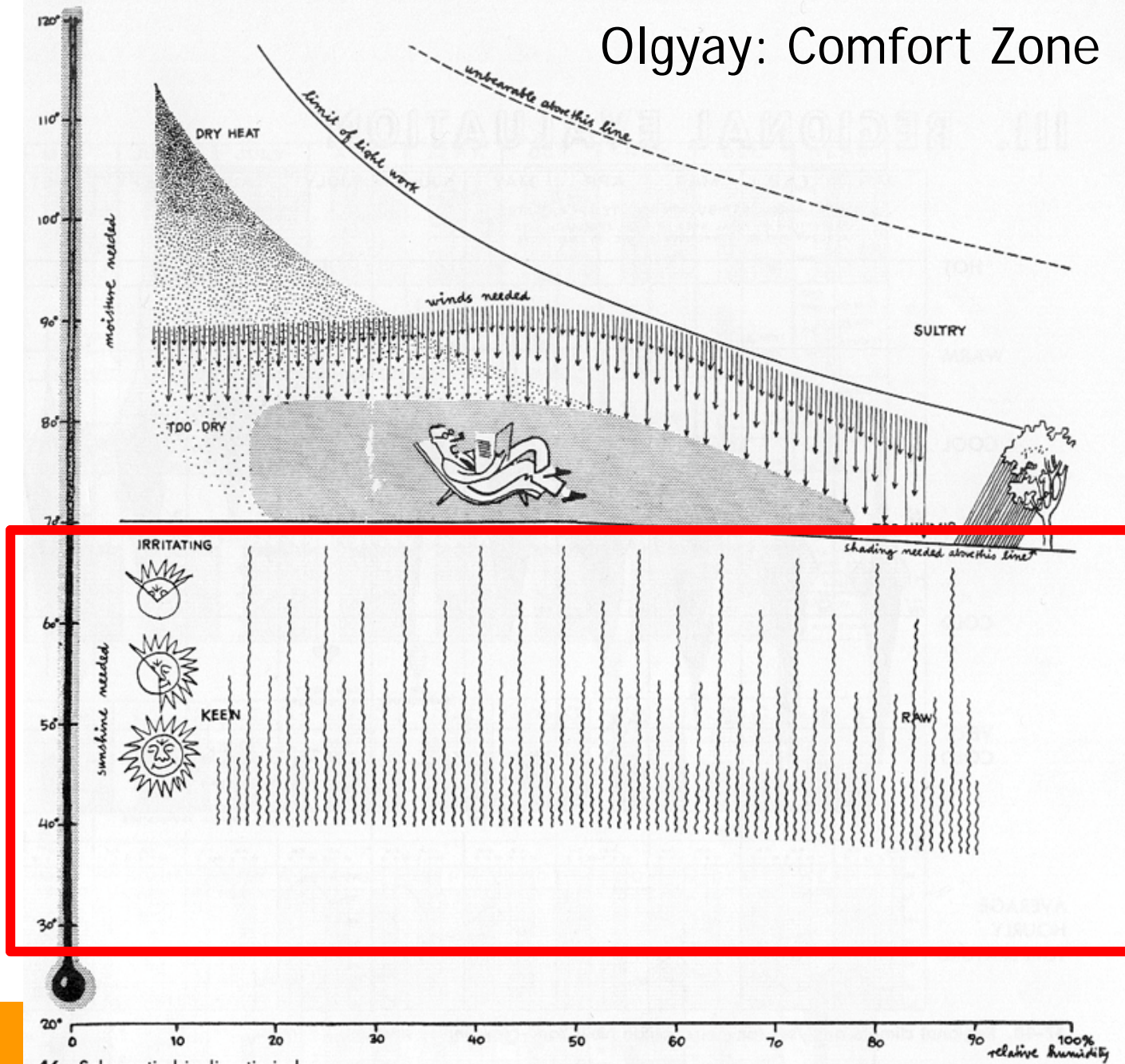

DWC

46. Schematic bioclimatic index.



# Strategies for Winter Climate Control

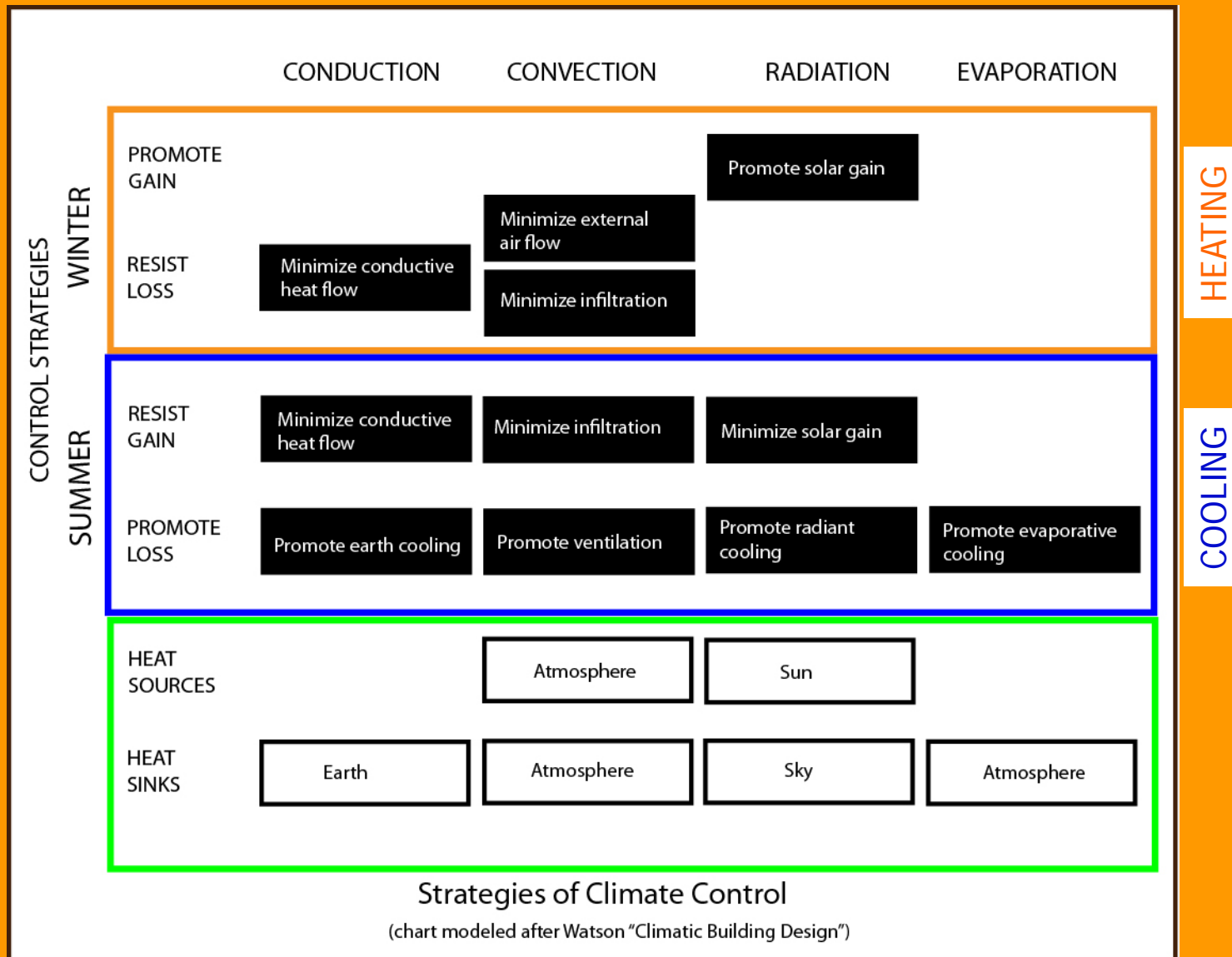

# Solar Savings

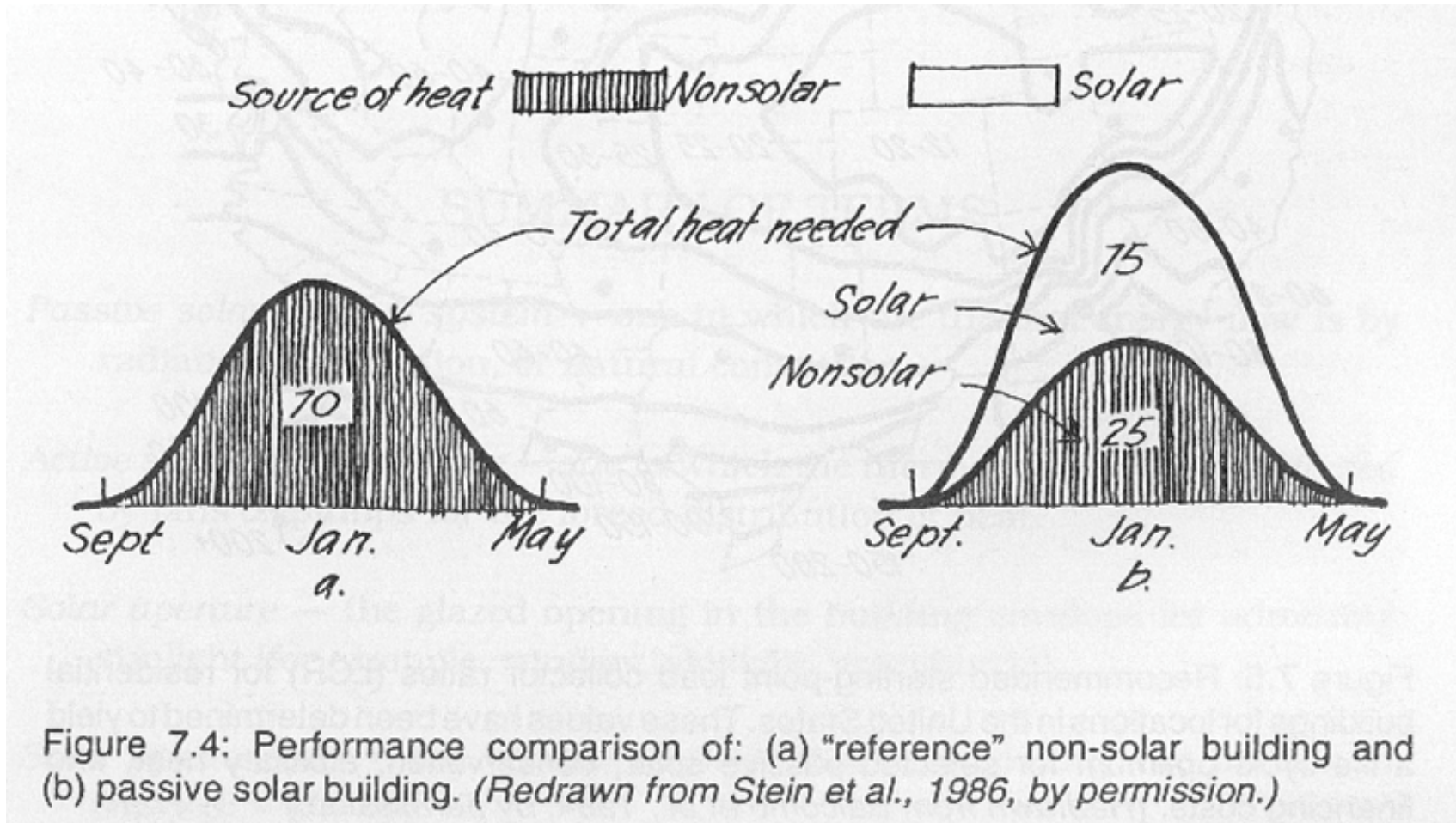

# Reduce loads: **Passive Strategies**

The tiered approach to reducing carbon for **HEATING**:

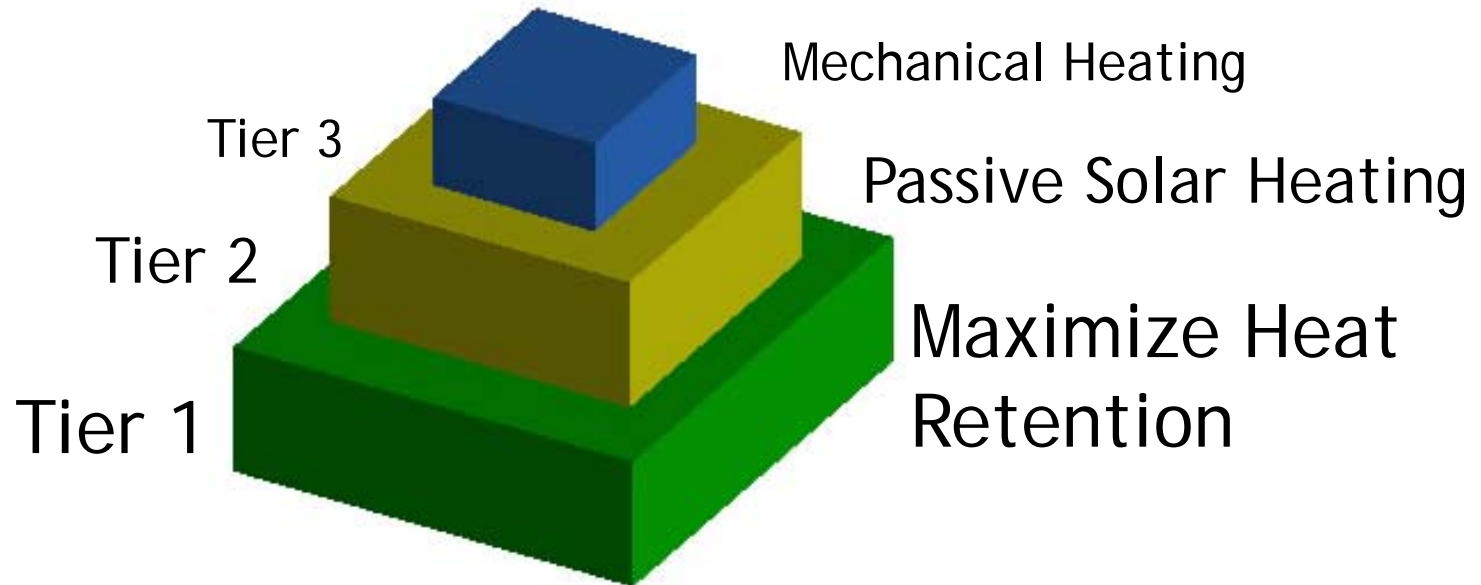

Maximize the amount of energy required for mechanical heating that comes from renewable sources.

•Source: Lechner. Heating, Cooling, Lighting.

# Passive SOLAR Heating Strategies:

1. primarily south facing windows
2. proportion windows to suit thermal mass and size of room(s)

## 3 MAIN STRATEGIES:

Direct Gain

Thermal Storage Wall  
(trombe)

Sunspace

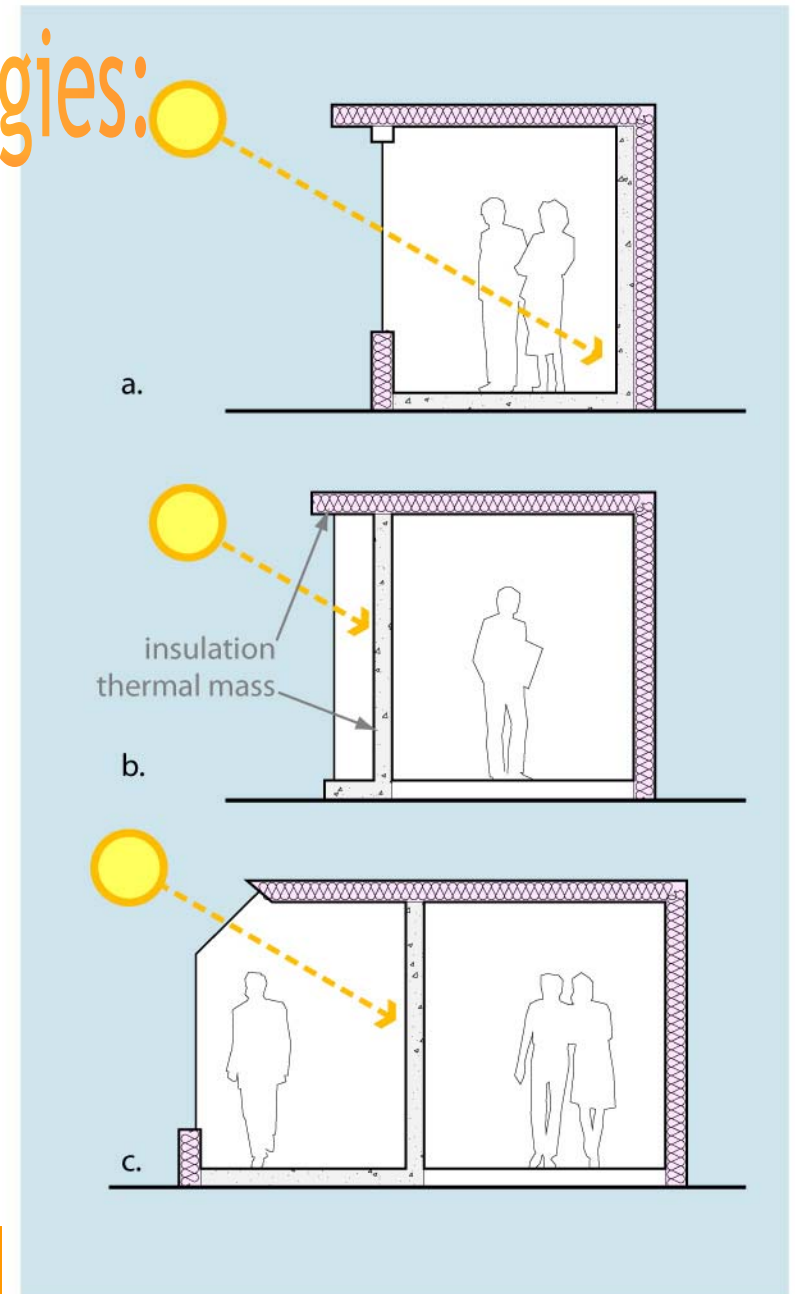

# General Rules:

ECS

1. **Conservation Levels:** Higher than normal levels of insulation and airtightness (maybe 2X)
2. **Distribution of Solar Glazing:** distributed throughout the building proportional to the heat loss of each zone
3. **Orientation:** Optimum within 5 degrees of true south
4. **Glazing Tilt:** Looking for perpendicular to sun angle in winter, although vertical efficient where lots of reflective snow cover
5. **Number of glazing layers:** 3 to 4 for severe climates, less otherwise
6. **Night insulation and Low-E glazing:** Greatly improves reduction of night heat losses
7. **Mixing passive systems can increase comfort levels.**

# General Rules:

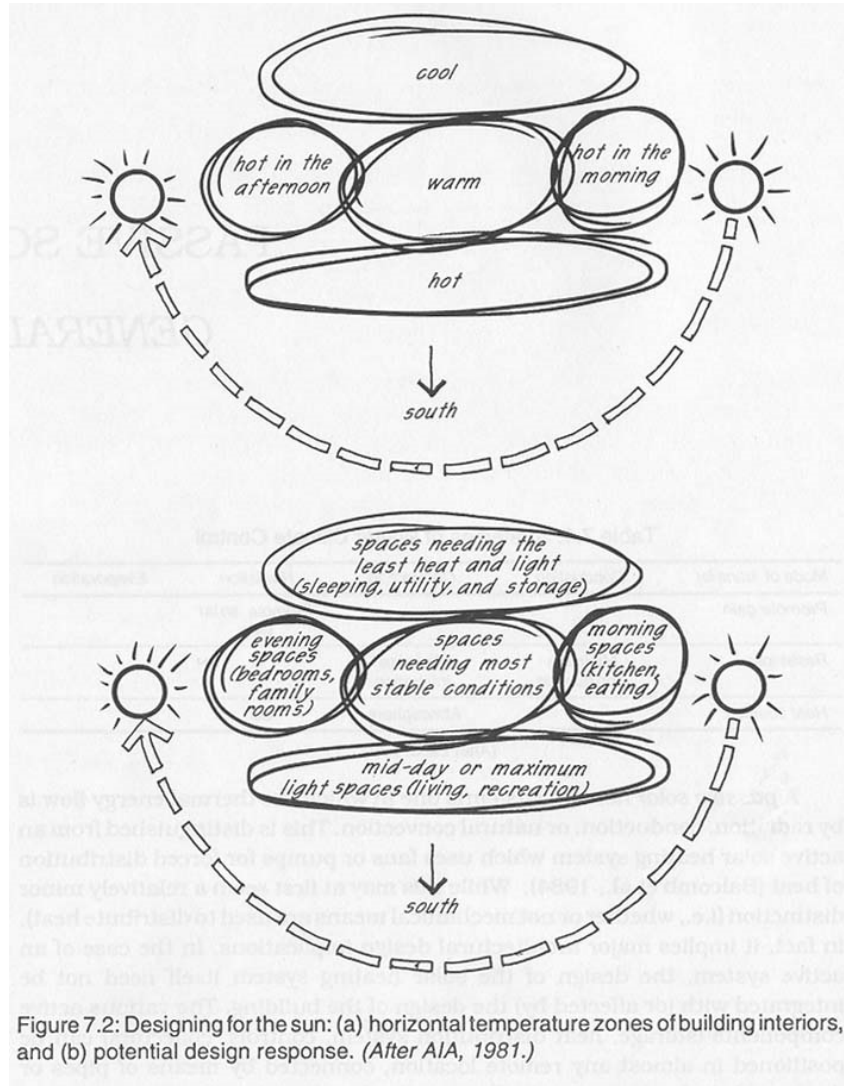

Figure 7.2: Designing for the sun: (a) horizontal temperature zones of building interiors, and (b) potential design response. (After AIA, 1981.)

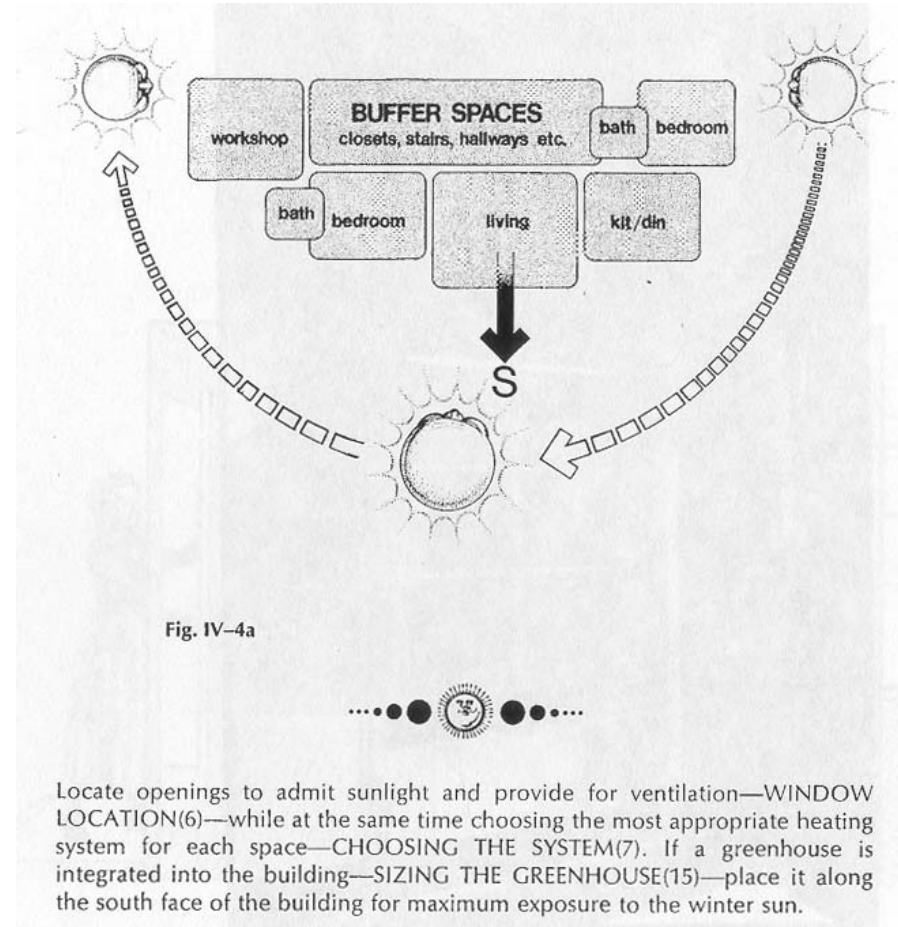

Fig. IV-4a

Locate openings to admit sunlight and provide for ventilation—WINDOW LOCATION(6)—while at the same time choosing the most appropriate heating system for each space—CHOOSING THE SYSTEM(7). If a greenhouse is integrated into the building—SIZING THE GREENHOUSE(15)—place it along the south face of the building for maximum exposure to the winter sun.

Louisiana's 2009 Solar Decathlon House:

South face, designed for solar energy - heating and electricity



North face has small openings to minimize heat loss.

# Insulating Bead Storage for Windows:

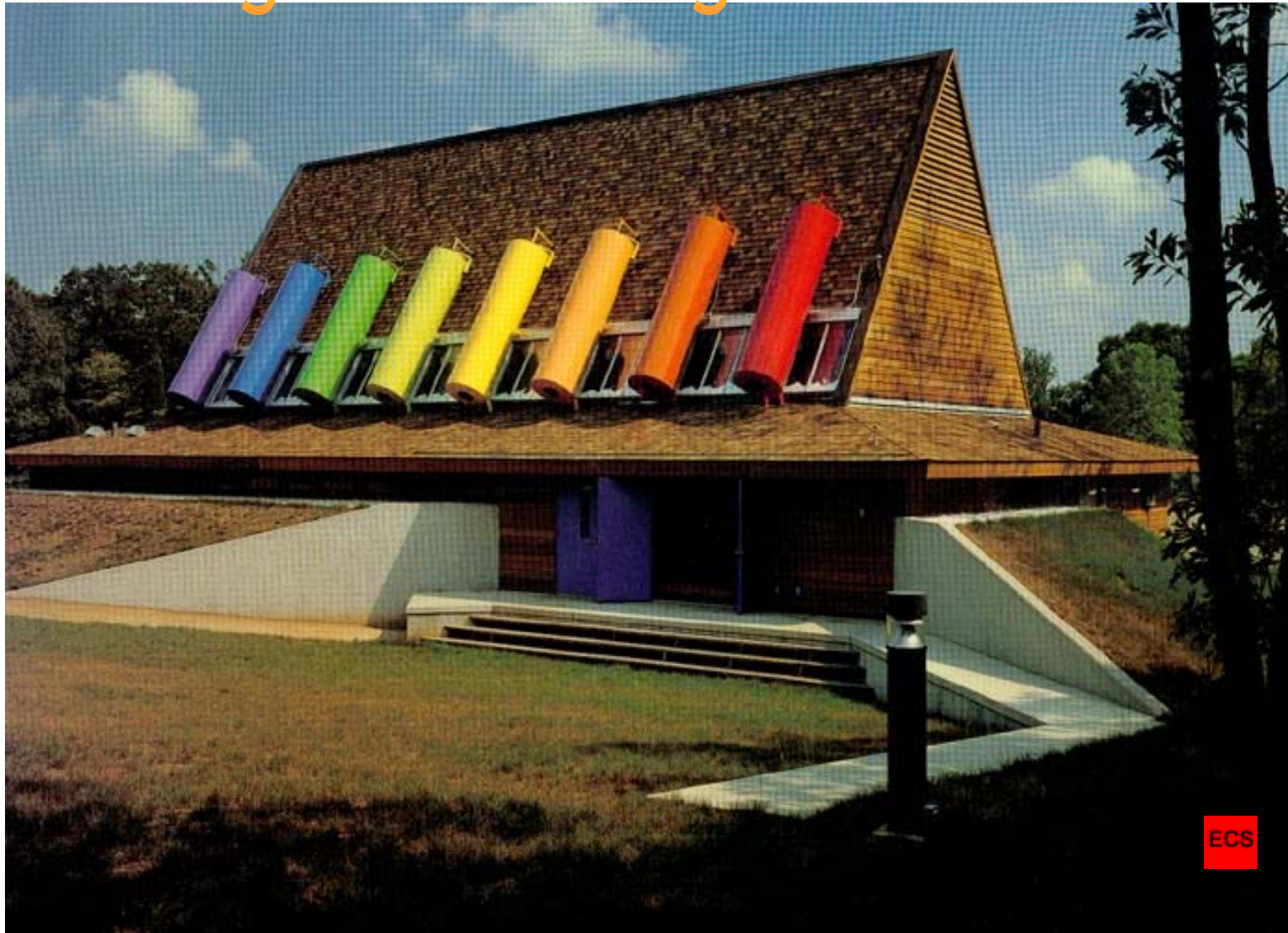

ECS



# Insulating Bead Storage for Windows:

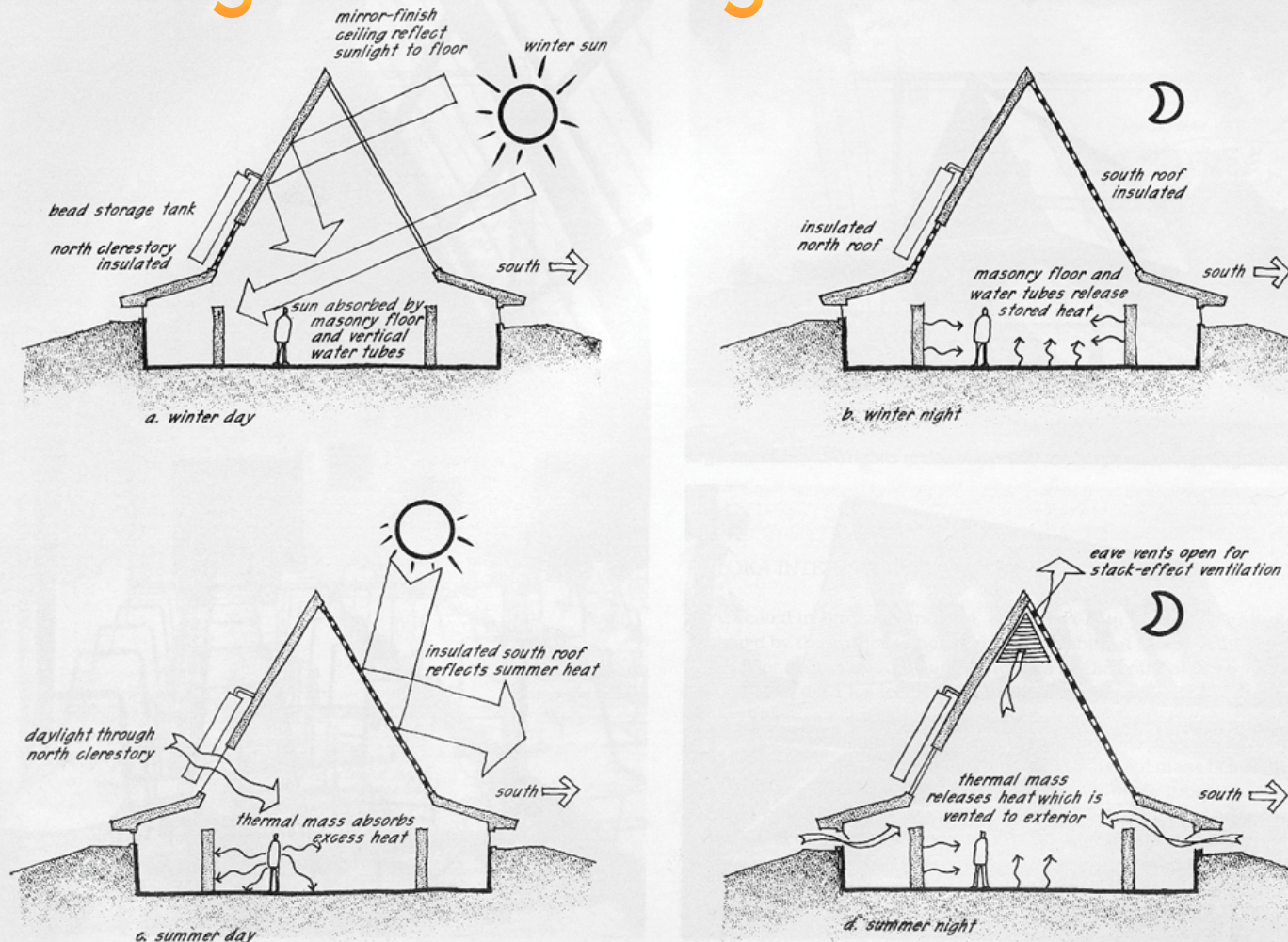

Figure 8.8: Patoka Nature Center modes of operation: (a) winter day, (b) winter night, (c) summer day, and (d) summer night. The building uses "night flushing" as a summer ventilation cooling strategy. Sixteen small awning windows over the exhibit booths admit air while large louvered exhaust eave vents are very effective in inducing stack effect night ventilation during the summer.

# New Technology: Super Windows

Heat Mirror Superglass-88 provides a U-Value of .11 (R-Value of 9.1) and Superglass-66 provides a U-Value of .10 (R-10). With R-values as high as 13.5, Superglass Quad exceeds the energy savings and year-round comfort of any glass on the market

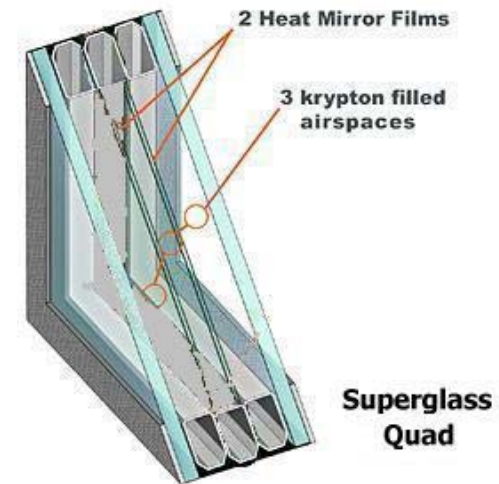
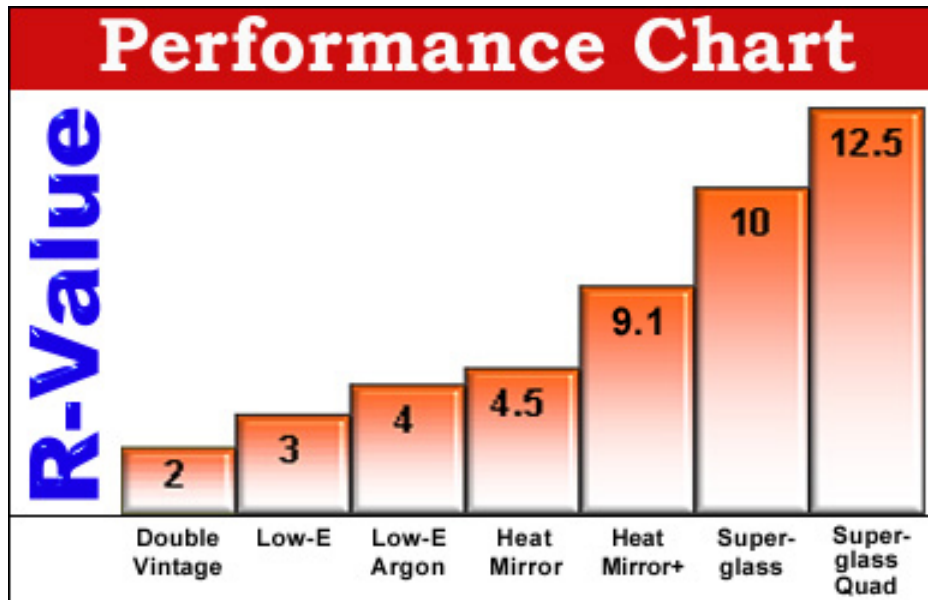

TABLE 19a

Thermal admittance expresses the "acceptability" a material has towards heat absorption and storage. Materials of high admittance quickly store and release heat (metals, for example) while materials of low admittance are relatively "indifferent" to heat presence—they respond slowly and hold little heat.

$$\text{THERMAL ADMITTANCE} = \sqrt{\text{CONDUCTIVITY} \times \text{HEAT CAPACITY}}$$

Material Description	Heat Capacity BTU/cu.ft (°F)	Conductivity BTU /hr (ft)°F	T. Admittance BTU/ft <sup>2</sup> (°F) √hr
Acoustic tile	5.8	.033	.44
Adobe	19.6	.37	2.7
Aluminum	35.9	128.	67.8
Brick, common (120 pcf)	24.	.42	3.2
Brick, face (130 pcf)	26.	.75	4.4
Concrete	29.4	1.0	5.4
Copper	51.	227	108.
Corkboard	24.6	.023	.27
Glass (Pyrex)	26.8	.59	4.1
Gypsum	51.3	.25	2.2
Iron, cast	54.	27.6	38.6
Limestone	34.7	.54	3.5
Marble	18.	1.5	7.1
Paraffin	18.6	.14	2.3
Particleboard (160 pcf)	27.7	.1	1.36
Plasterboard	22.4	.43	3.1
Plywood	9.9	.067	.81
Polystyrene (Beadboard)	.3	.023	.083
Sand	18.	.19	1.85
Soil, light & dry (80 pcf)	18.	.2	1.9
Soil, average (damp, 131 pcf)	30.1	.75	4.75
Soil, wet (117 pcf)	35.1	1.4	7.0
Wood, hardwood	18.7	.09	1.3
Wood, white oak	26.8	.1	1.6
Wood, softwood	10.6	.067	.84
Wood, white pine	18.1	.063	1.07
Water, still*	62.4	.35 *	4.67 *
Glass, cellular insulation	2.2	.033	.27
Lead	21.8	20.1	20.9
Ice	27.	1.35	6.04
Bakelite	20.4	9.7	16.6
Steel (mild)	58.7	26.2	39.2
Granite	31.7	1.40	6.6

\*The "apparent" admittance of stirred water is much higher, due to increase in heat transfer (apparent conduction) by convection; it may range from 8 to 400 times greater than still water.

# Heat Capacity of Materials

Passive heating requires buildings be able to store free solar heat in their materials - need to have THERMAL MASS

Material	Density(Kg/m3)	Specific heat(kJ/kg.K)	Thermal mass (kJ/m3.K)
Water	1000	4.186	4186
Concrete	2240	0.920	2060
AAC	500	1.100	550
Brick	1700	0.920	1360
Stone (Sandstone)	2000	0.900	1800
FC Sheet (compressed)	1700	0.900	1530
Earth Wall (Adobe)	1550	0.837	1300
Rammed Earth	2000	0.837	1673
Compressed Earth Blocks	2080	0.837	1740

Imperial

Metric

# What is Direct Gain??

**Direct Gain:** A passive solar heating system type consisting of

- south-facing windows that admit winter sunshine directly into the building's interior where it is absorbed by thermally massive materials.
- glazing is protected from the summer sun by an overhang.
- Some means of reducing night heat loss through the glazing (such as night insulation or low-e glass) is recommended in all but the mildest climates.



# What are Sun Tempered Buildings??

**Sun tempered buildings:** direct gain buildings with NO intentional thermal mass (for example, a conventionally constructed wood frame with 1/2" gyp bd walls and ceiling and a wood floor over a crawl space). South facing glazing should be less than 7% of floor area to prevent overheating.



# Direct Gain:

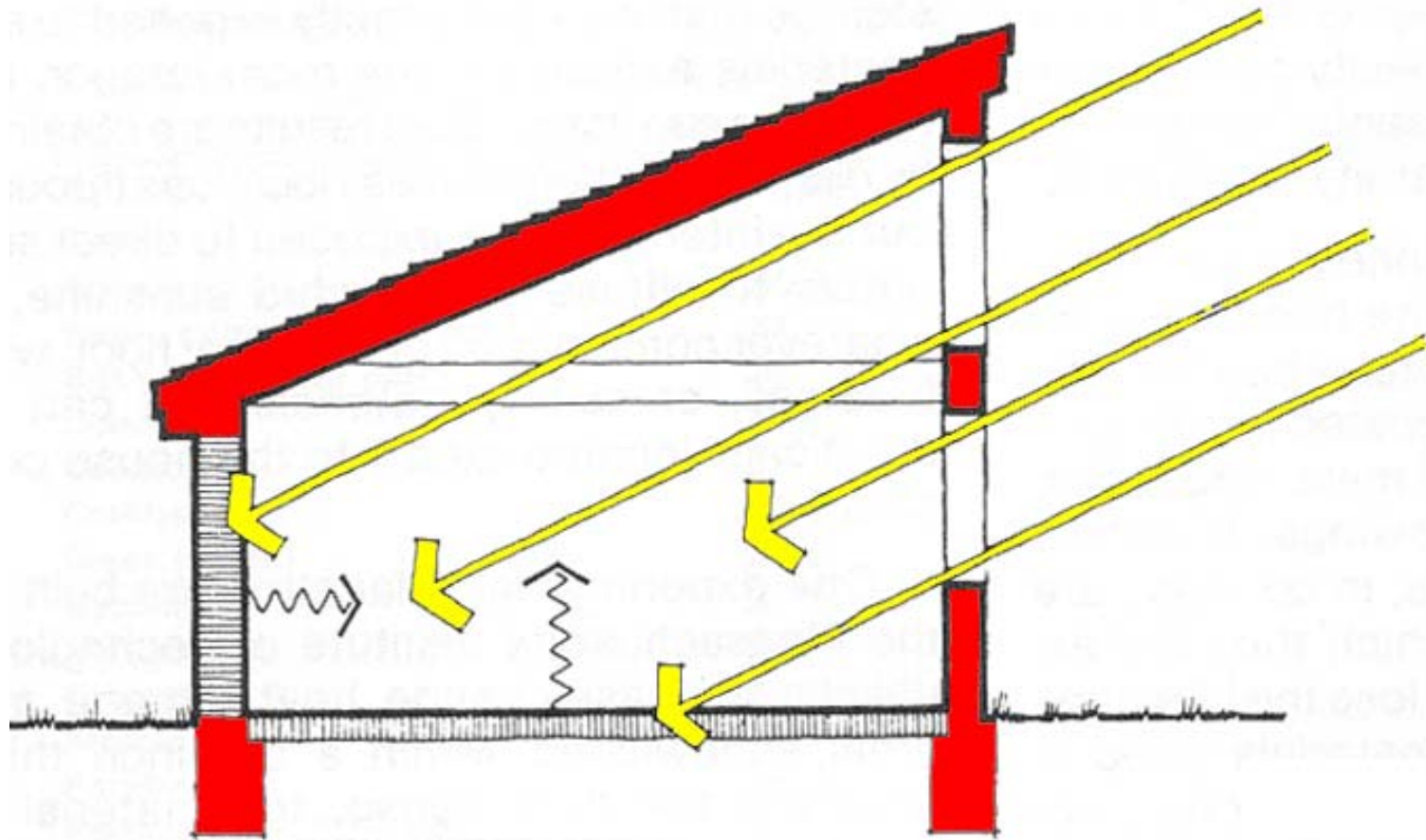
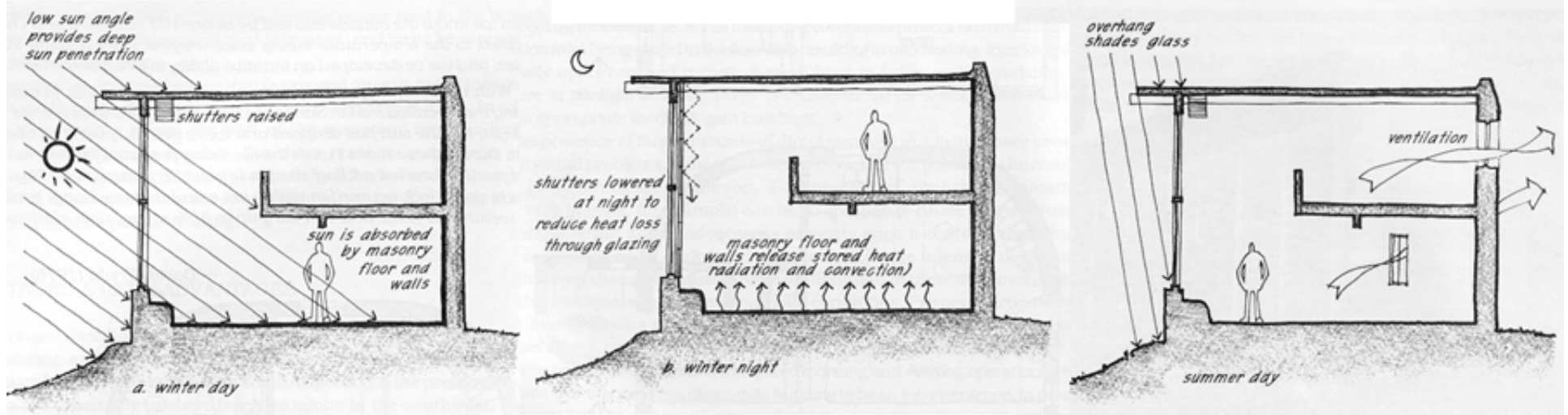

FIG. 19a. Direct Gain



# Direct Gain:



ECS

The direct gain system makes overt use of solar geometry to ensure that sun reaches the thermal mass in the winter, and that shading devices prevent solar access during the months where cooling is the dominant issue.

# Direct Gain - night insulation:

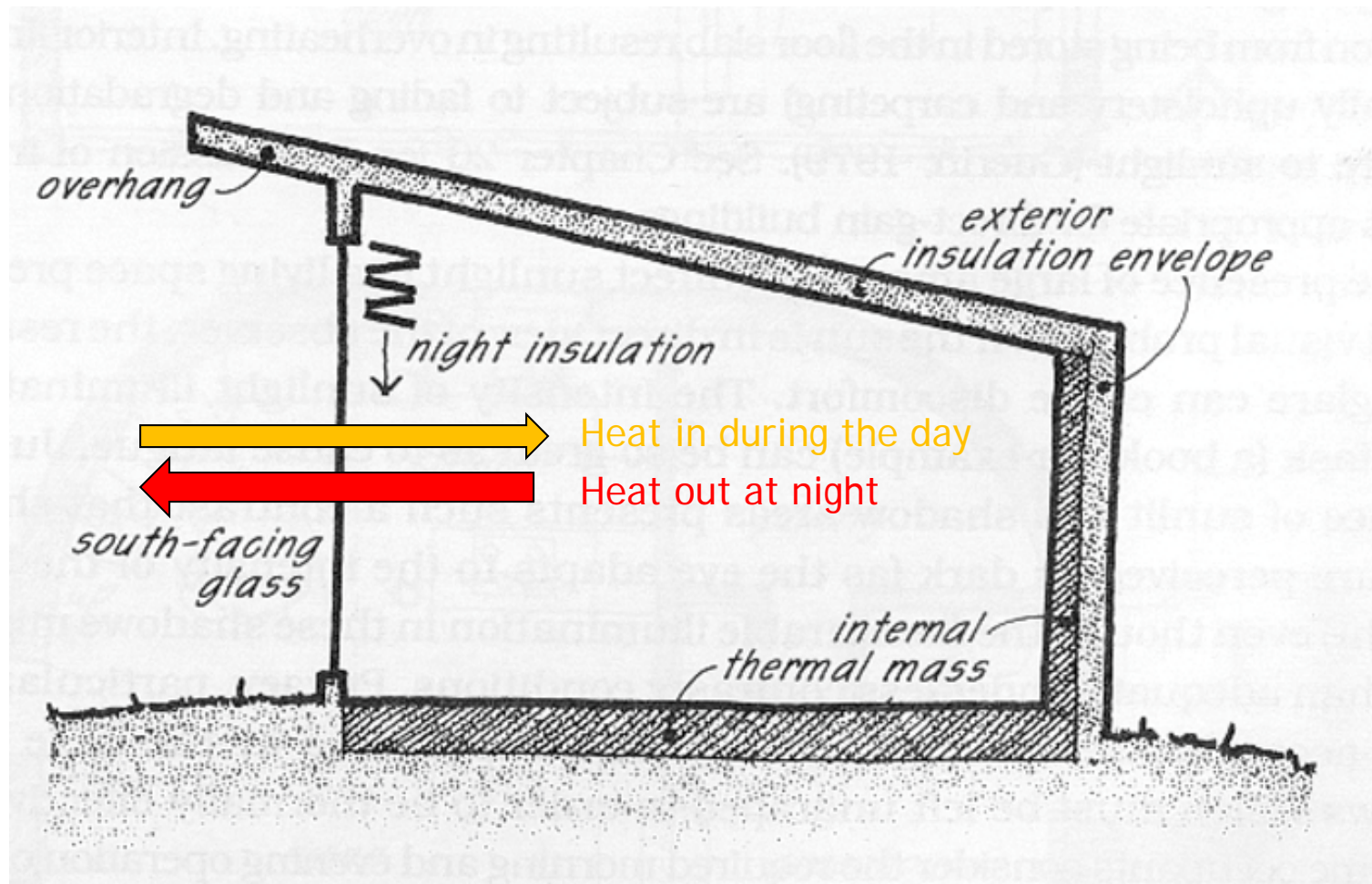



## Night insulation

Most devices that you might employ to keep heat in at night are custom designed.

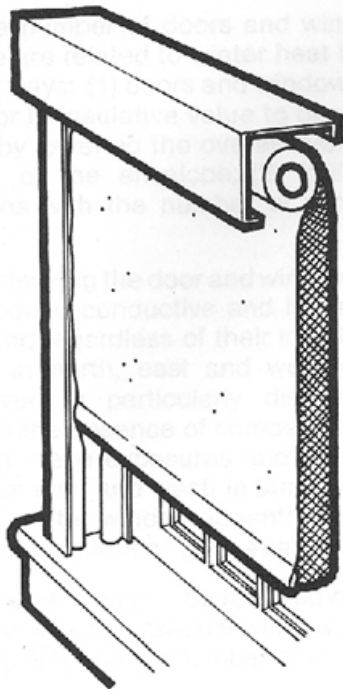

FIG. 39b. An insulating shade is designed to minimize conductive & radiative heat transmission, as well as a seal against infiltration.

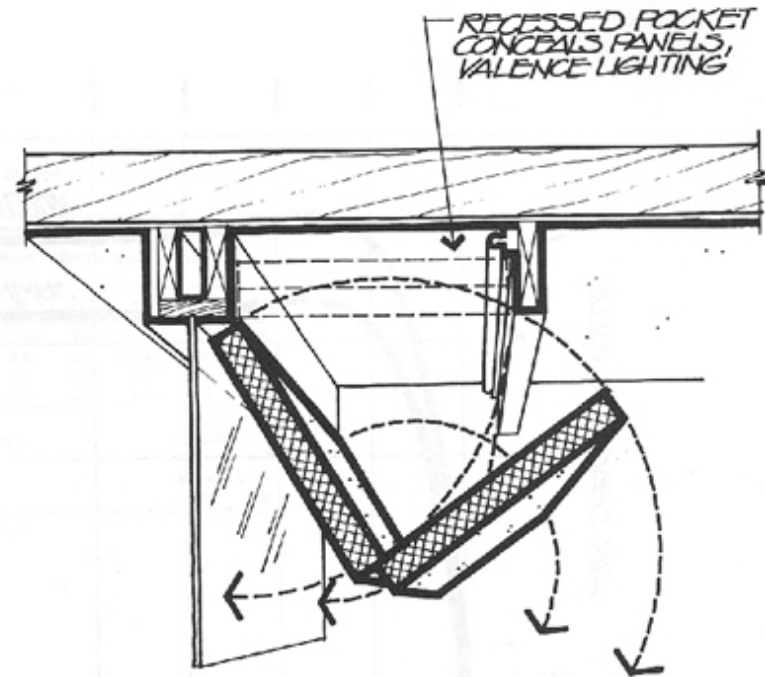

FIG. 39c. Hinged and fold-down panels offer large additional resistances to window units, can be made from aluminum-faced urethane or polystyrene sandwich panels, or insulation board w/laminated facings.

# Direct Gain:

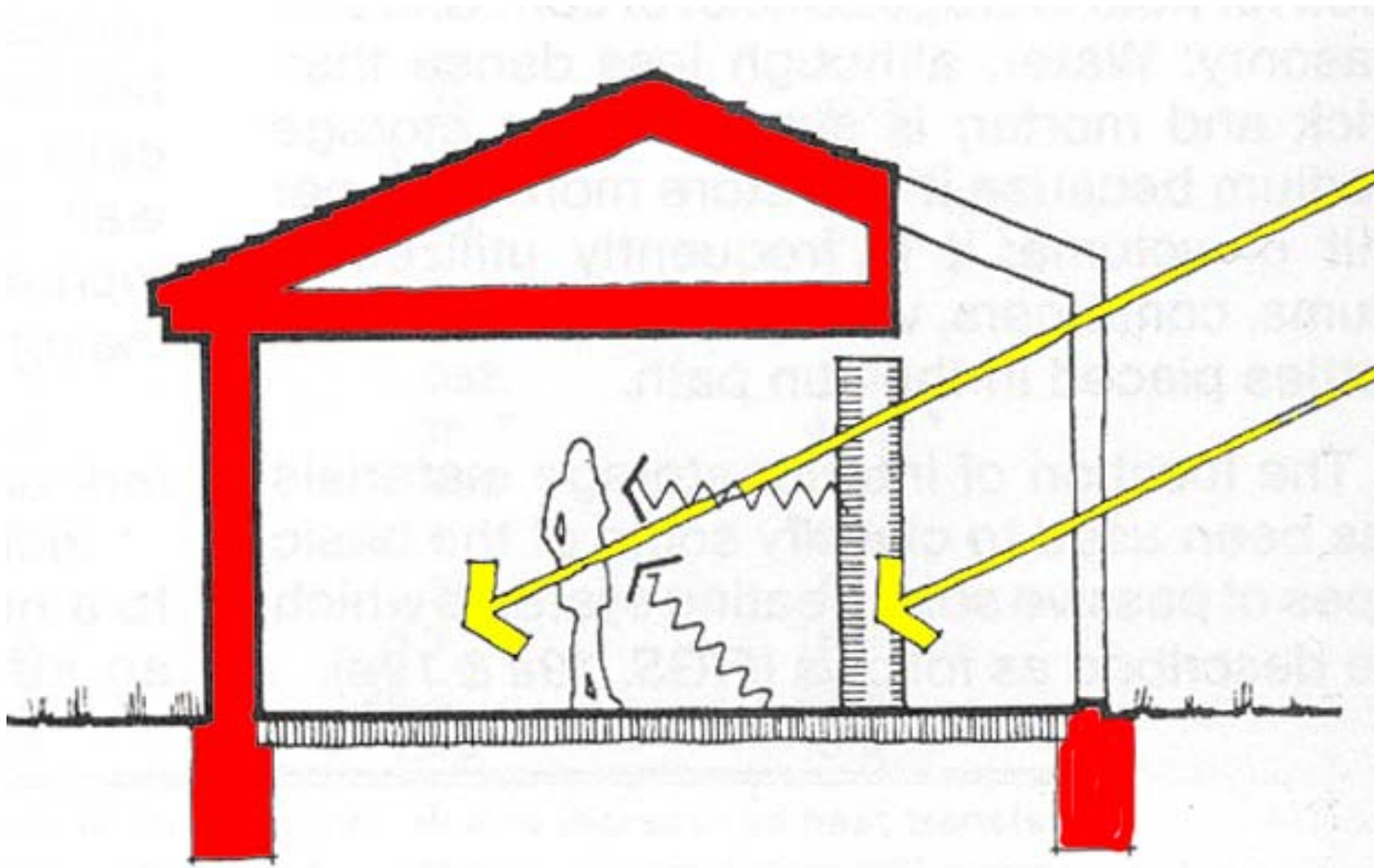

FIG. 19b. Direct and Indirect Gain

# Direct Gain:

Finished in 1962, St. George's County Secondary School in Wallasey, England is one of the earliest and largest contemporary examples of a Direct Gain System.

Public reaction to the building at that time was that the architect had somehow harnessed a new physical principle.

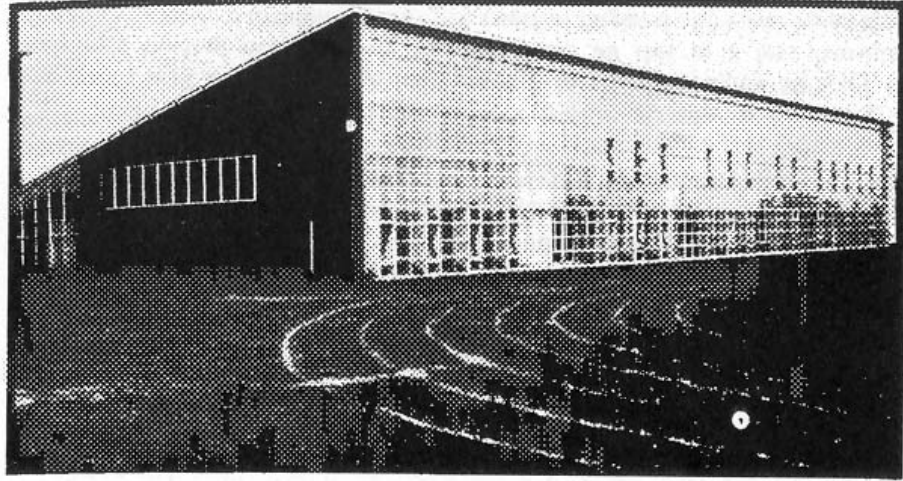
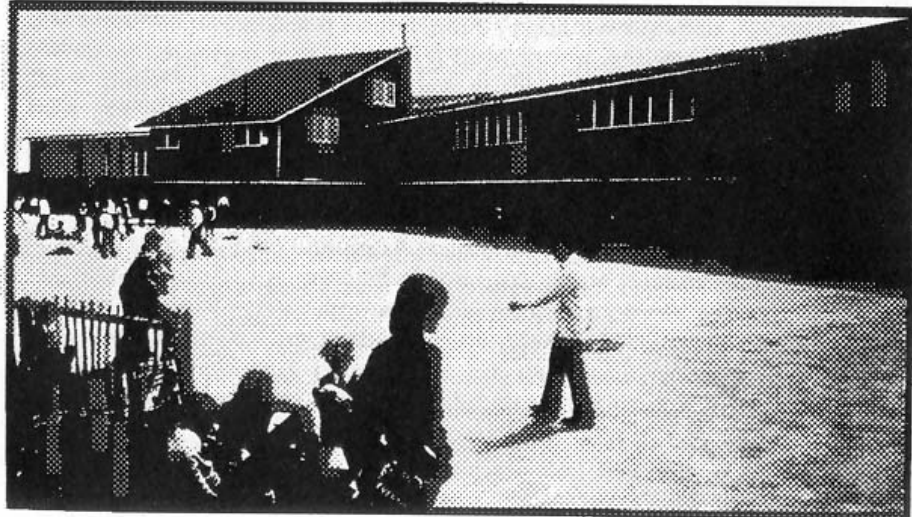

Photo III-1: South and north face of St. George's County Secondary School.



# Direct Gain:

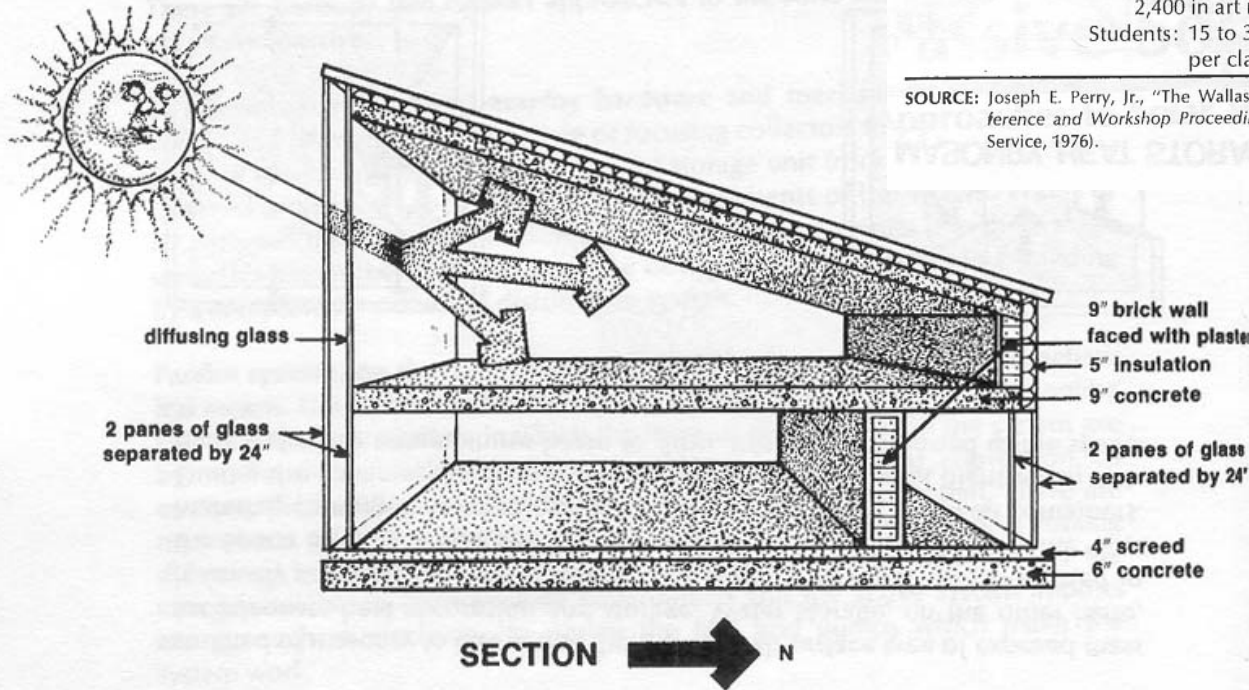

Fig. III-2: Sunlight is diffused over a large surface area of masonry.

Table III-1 Principal Heat Sources

Source	Percentage of Heating Supplied (rough estimate) (1960-69)
Solar energy	50
Incandescent lights	34
1,300 in classroom	
2,400 in art room	
Students: 15 to 35 students per class	16

SOURCE: Joseph E. Perry, Jr., "The Wallasey School," *Passive Solar Heating and Cooling Conference and Workshop Proceedings* (Springfield, Va.: National Technical Information Service, 1976).

The building is heated 50% by the sun with the remaining 50% supplied by lights and students. The conventional heating system, originally installed, was never used and subsequently removed.

# Direct Gain Rules:

- ECS** 8. **Mass Distribution:** spread it around evenly; 6 times glazing area (3X minimum)
- 9. **Mass Thickness:** thin and spread out better than thick. More than 4" for masonry or concrete not useful
- 10. **Colour:** Floors dark to absorb more heat, walls and ceilings lighter to reflect light.
- 11. **Surface Covering:** insulative coverings (ie. Rugs) greatly decrease performance of thermal mass
- 12. **Concrete Block Masonry:** If used, a high density with cores filled with grout

# Direct Gain Rules, cont'd:

- ECS** 13. **Floor Materials:** Concrete or brick preferred. If insulating under, at least 4" thick (100mm). More than 6" (150mm) not useful.
14. **Limits on Direct Gain Glazing Area:** South facing glazing limited to prevent large temperature swings. 7% of floor area for low mass buildings, 13% of floor area for high mass buildings.
15. **Glazing orientation:** Vertical facing due south preferred. Vertical easiest to build, and easiest to shade in summer. Performance penalty for 15degrees off due south is 10% and for 30 degrees is 20% loss; so within 15 degrees recommended.
16. **Night insulation:** Really helpful but can be very costly.
17. **Thermal Insulation:** **Insulation located OUTSIDE the thermal mass.**



YMCA Burrows Building



The white brick wall in the YMCA Burrows building is used to hold the heat that comes into the building through the windows. This is done in this wall, rather than in the floor (more usual), as the kids will be walking around in stocking feet.



## YMCA Burrows:

Rear wall and mid wall are used for heat storage. North side is built into the earth. Mostly linear organization with spaces facing south.

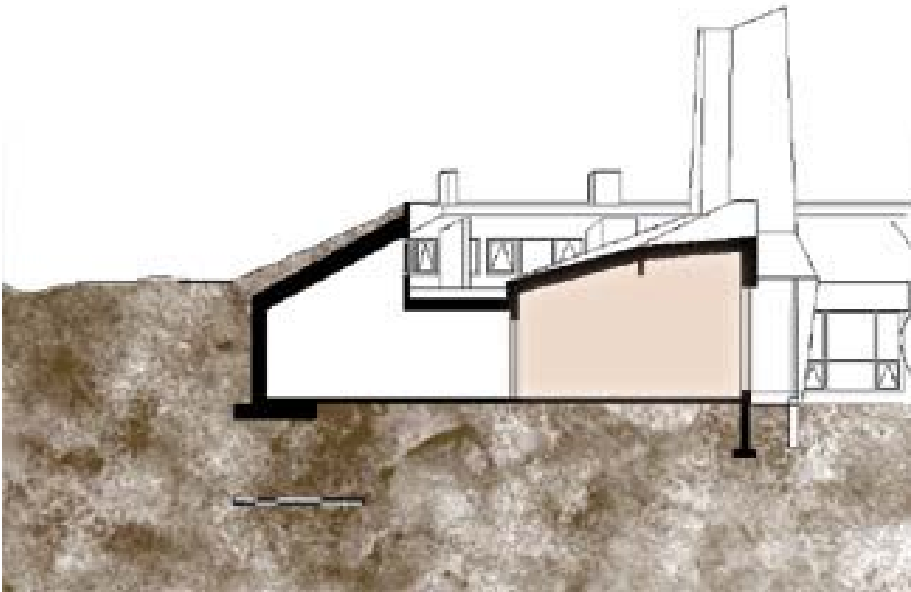
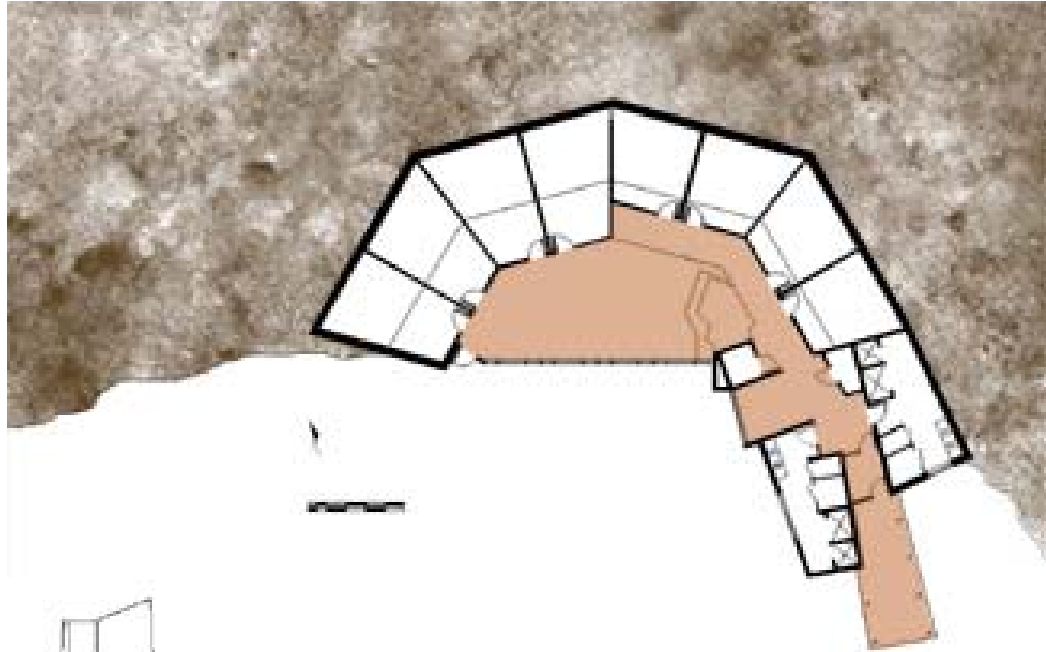





For North House, there was a phase change material underneath the wood floor that would absorb solar energy when the shades were up (and it was determined that heat was needed).

# What is a Thermal Storage Wall??

**Thermal Storage Wall** -- a passive solar heating system consisting of a south facing wall constructed of heavy masonry (Trombe Wall) or water filled containers (water wall). The outside south facing surface is glazed to admit sunlight and reduce heat losses.

**Trombe Wall** -- a thermal storage wall system consisting of a dark, south facing masonry wall covered with vertical glazing.

**Water Wall** -- a thermal storage wall system consisting of water filled containers located behind a south facing glazing.



# Trombe Walls:

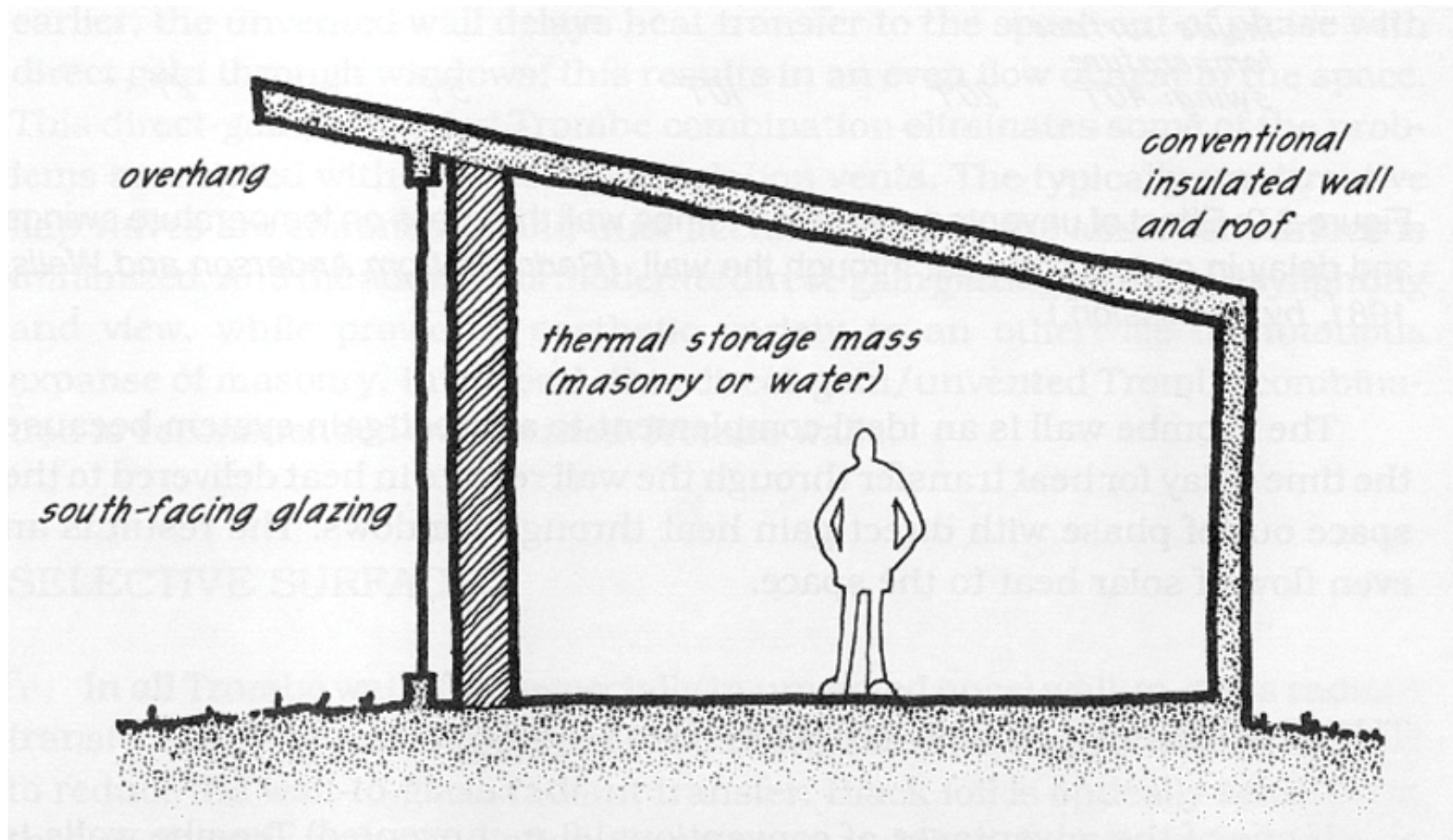

# Trombe Walls:

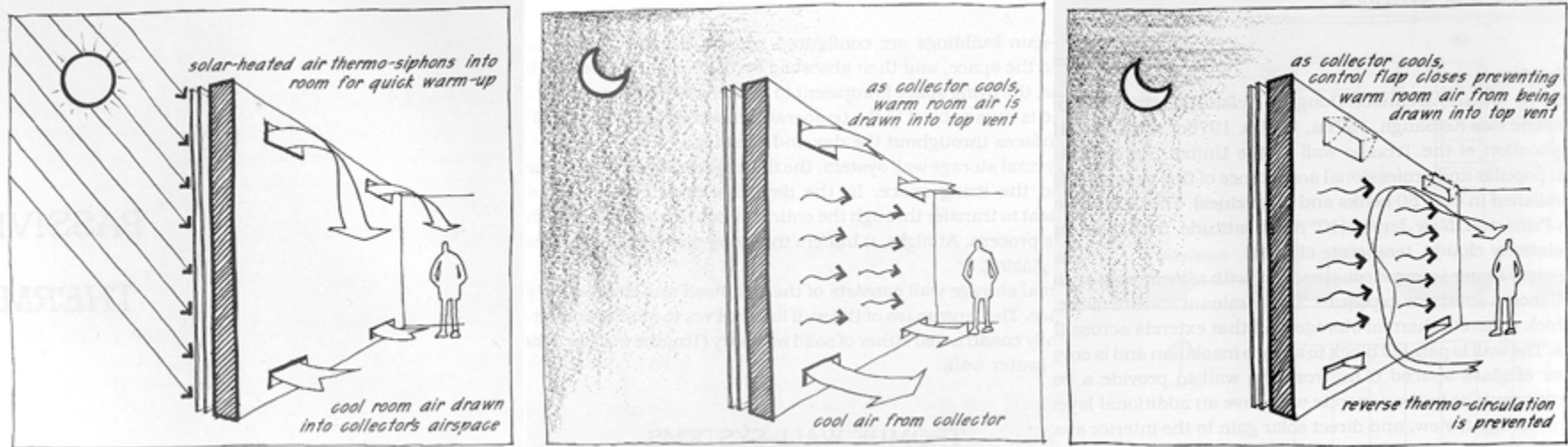

ECS

Whether or not a wall has flaps, and flaps that automatically close off when the air direction reverses, becomes a critical issue in making sure that preheating of the room occurs in the morning hours.

# Trombe Walls:



Figure 9.5: Kelbaugh house showing south facade with Trombe wall. (Photo courtesy of D. Kelbaugh.)

ECS

# Trombe Walls:

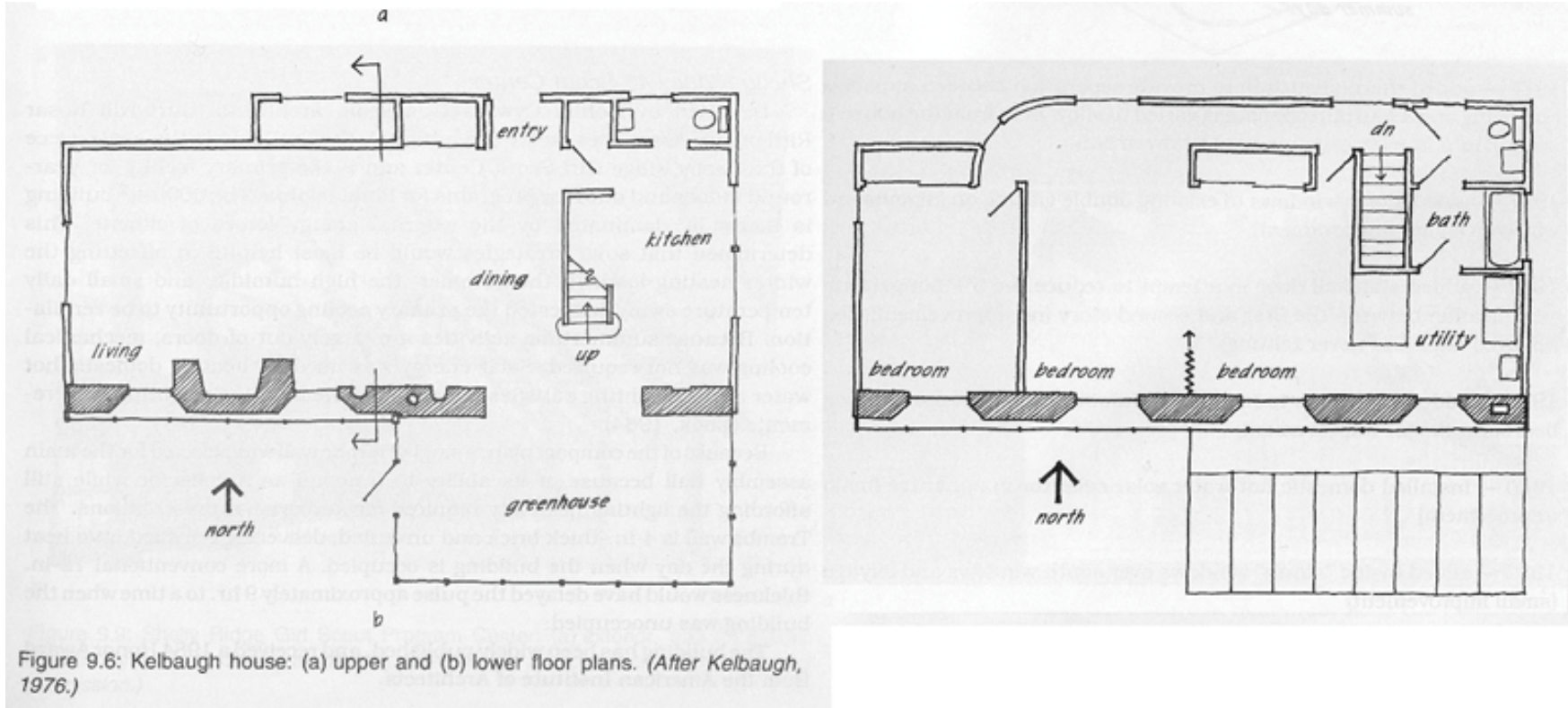



# Trombe Walls:

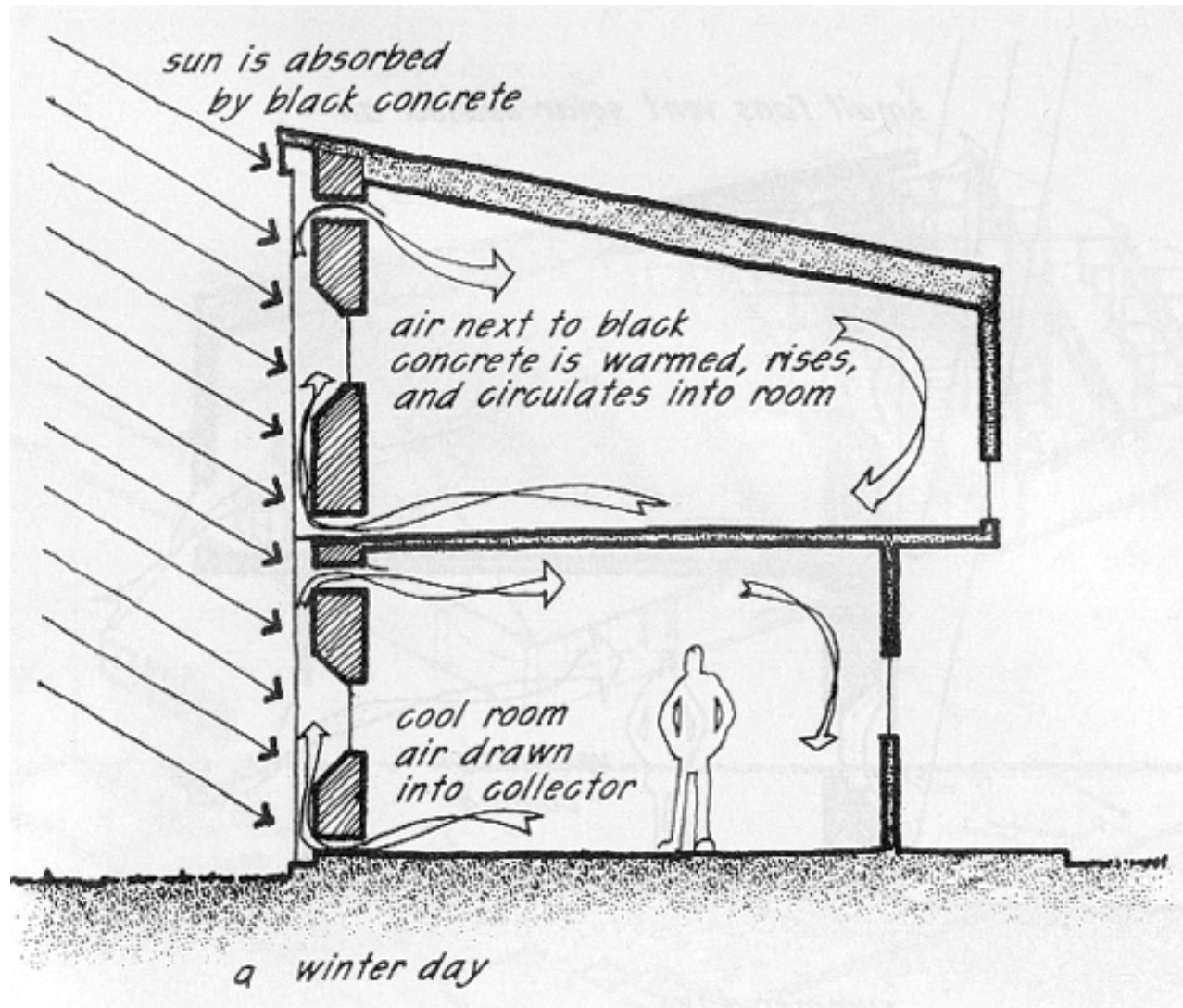

# Trombe Walls:

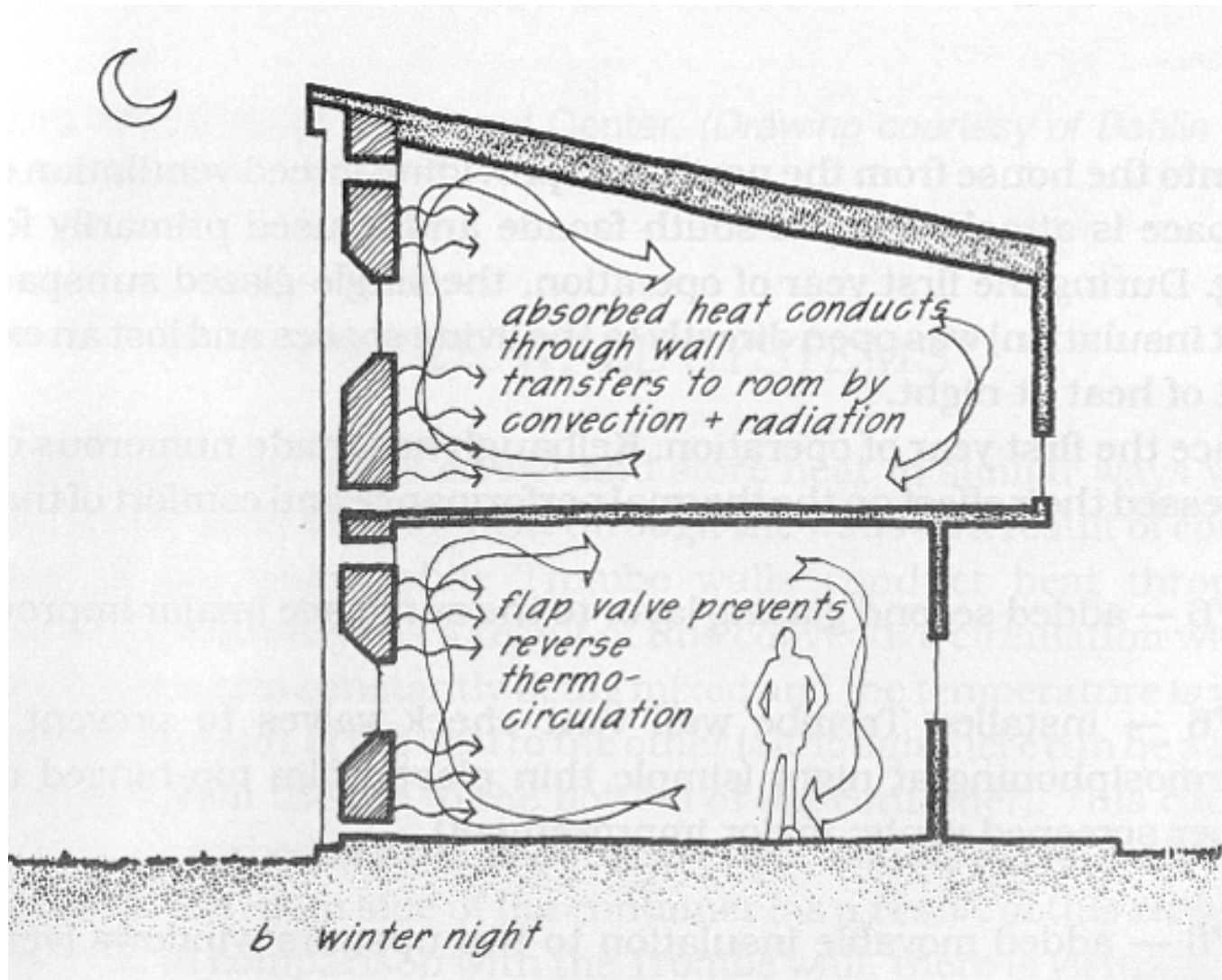

# Trombe Walls:

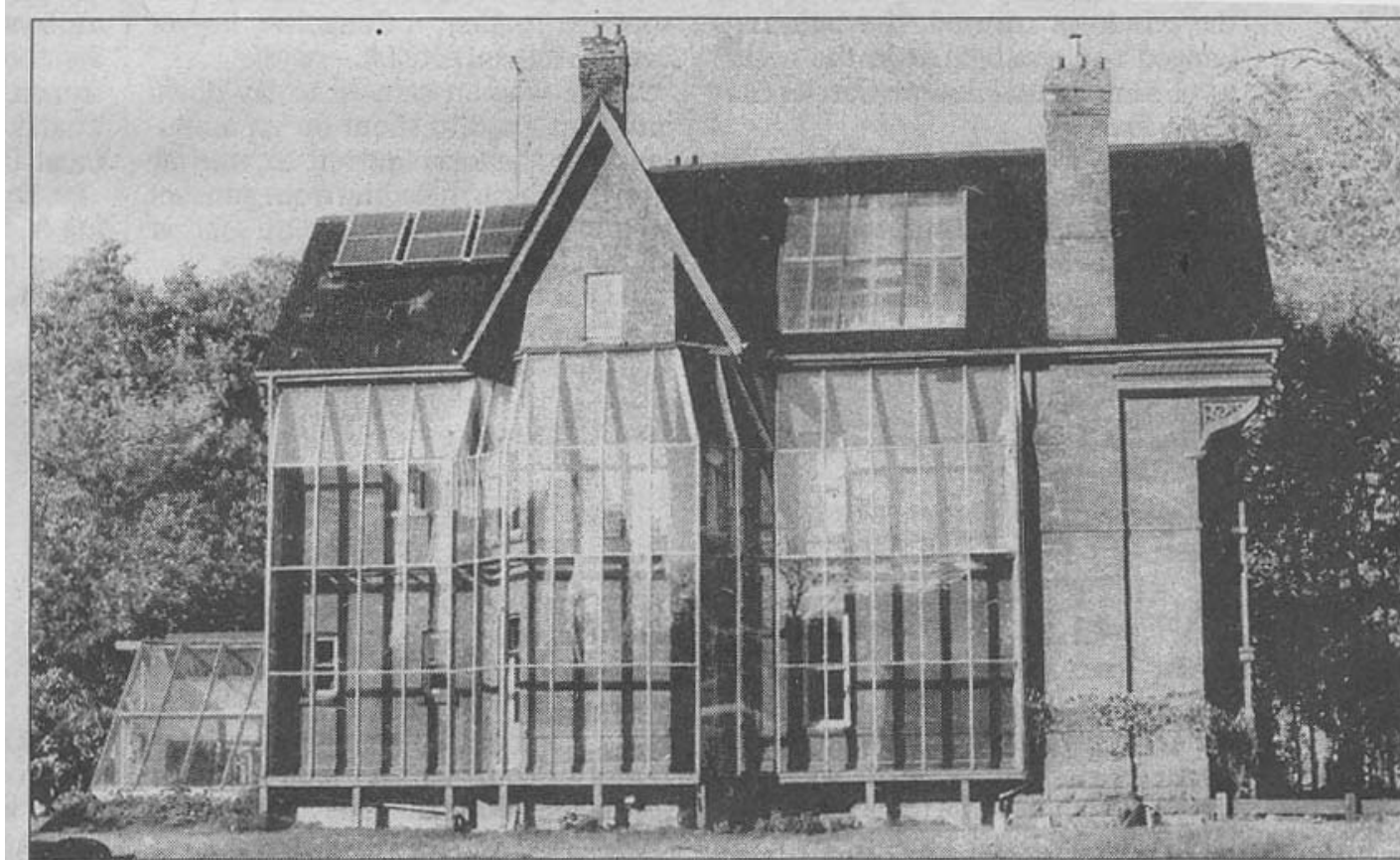

POLLUTION PROBE PHOTO

**A Trombe wall was installed on Ecology House in Toronto, following the energy crunch of the 1970s. The three-storey, glass wall, since removed, trapped solar energy for heating. With this year's oil price hikes, the concept of green buildings may be undergoing a revival. In the top photo, a worker at a housing site in Caledon runs his saw from the electricity generated by the solar panel next to him.**

# Trombe Walls:

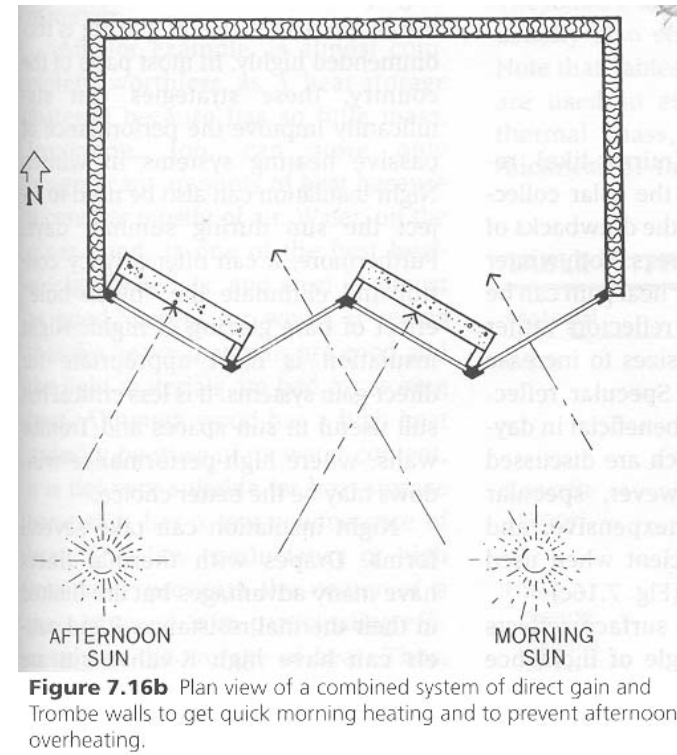
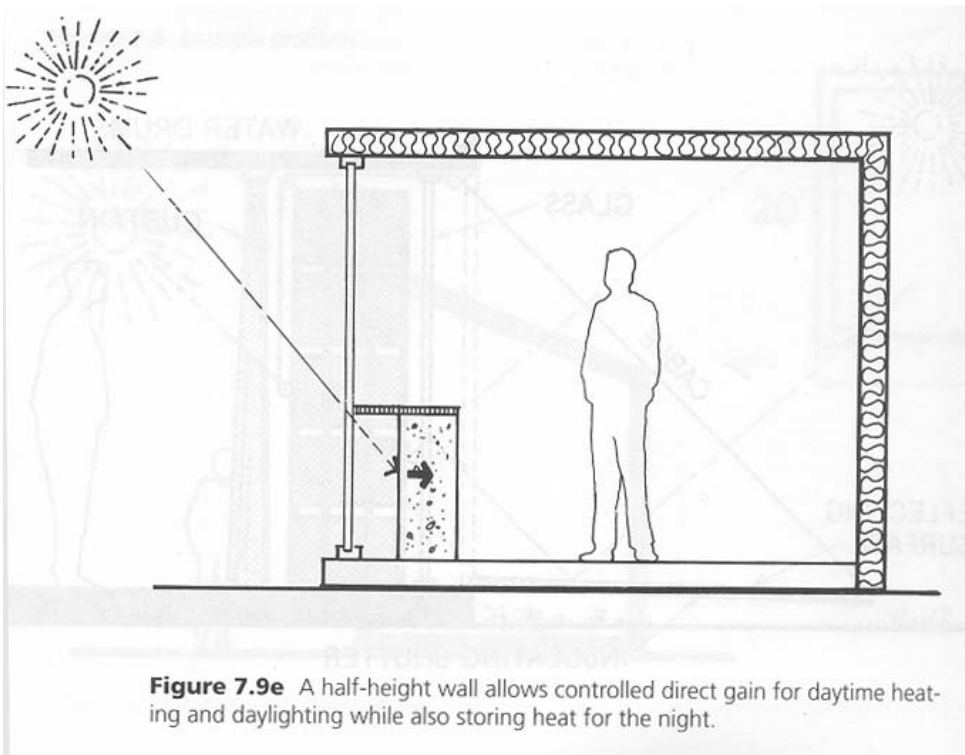

# Trombe Walls:



**Figure 7.9d** A Trombe wall can consist of vertical tubes filled with water. The tubes can be opaque, translucent, or transparent. (Courtesy of and © Solar Components Corporation.)

HCL

# Trombe Walls:

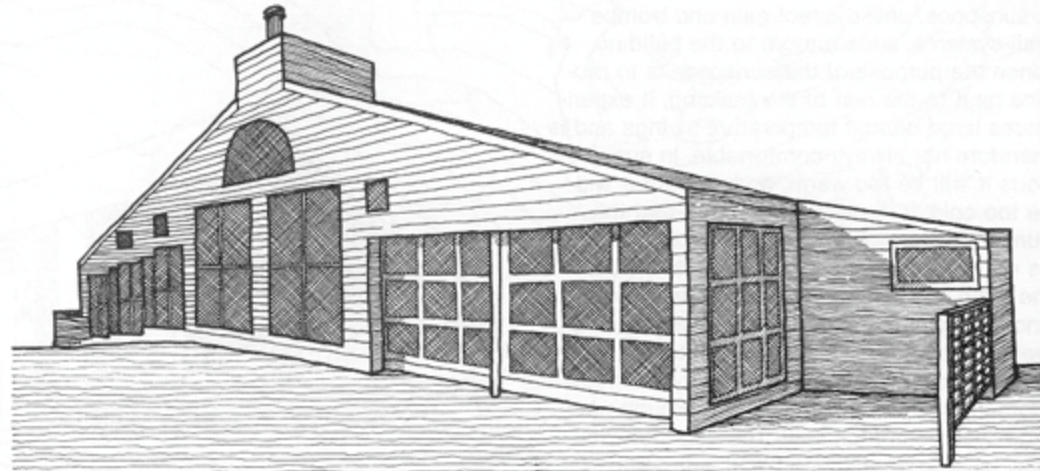

Sisko House Metuchen, New Jersey Kelbaugh & Lee

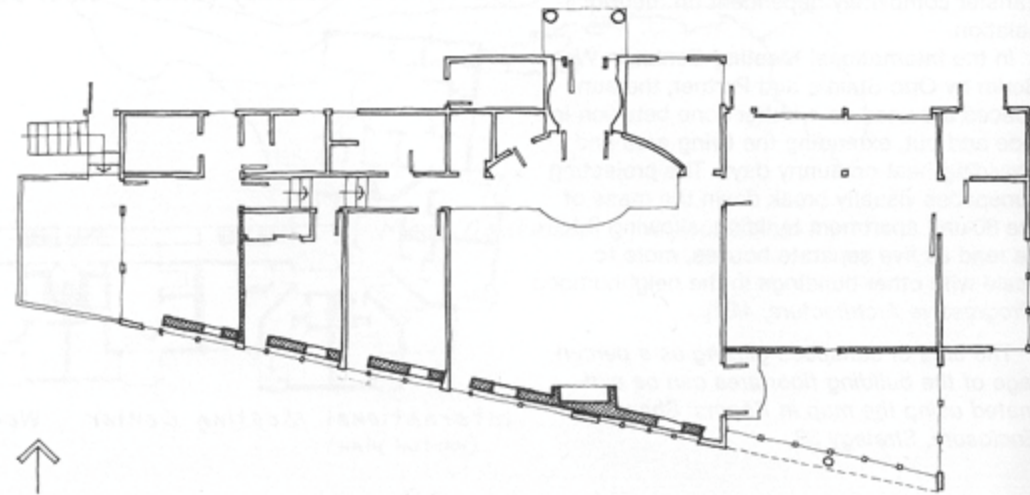

Sisko House Metuchen, New Jersey Kelbaugh & Lee

SWL



Arizona's house at the 2009 Solar Decathlon used a trombe wall made from water. Water has a high thermal storage capacity and is very "portable".

# Thermal Storage Wall Rules:

- ECS** 18. **Glazing azimuth:** directional orientation preferred is due south. Within 30degrees of due south only a 4% penalty.
- 19. **Vents:** generally used in larger applications but omitted in residential. In larger applications can be beneficial.
- 20. **Glazing distance:** *Unvented*, 1" is enough. *Vented*, 6" or more is better.
- 21. **Trombe Wall Thickness:** between 10 and 16" . 12" recommended.
- 22. **Water Walls and Phase Change Materials:** more effective than concrete so smaller volume necessary.



# Thermal Storage Wall Rules, cont'd:

**ECS** 23. **Selective Surfaces:** on outside face of thermal mass part of wall can greatly increase performance. No venting.

24. **Absorber colour:** for solid materials, use black. Applicable to solid colour containers for water walls too. Transparent or fiberglass water containers will allow some visible light through the container which will be absorbed by direct gain means beyond, so OK too.

# What is a Sunspace??

**Sunspace** -- a passive solar heating system type consisting of a glassed-in room like a greenhouse, atrium or conservatory, located on the south side of a building and separated from other building spaces by a common wall.

**Common Wall** -- a wall separating a sunspace from other living spaces.

**Greenhouse** -- a sunspace used primarily for growing plants

**Projected Glazing Area** -- net glazing projected onto a single vertical wall.



# Sunspaces:

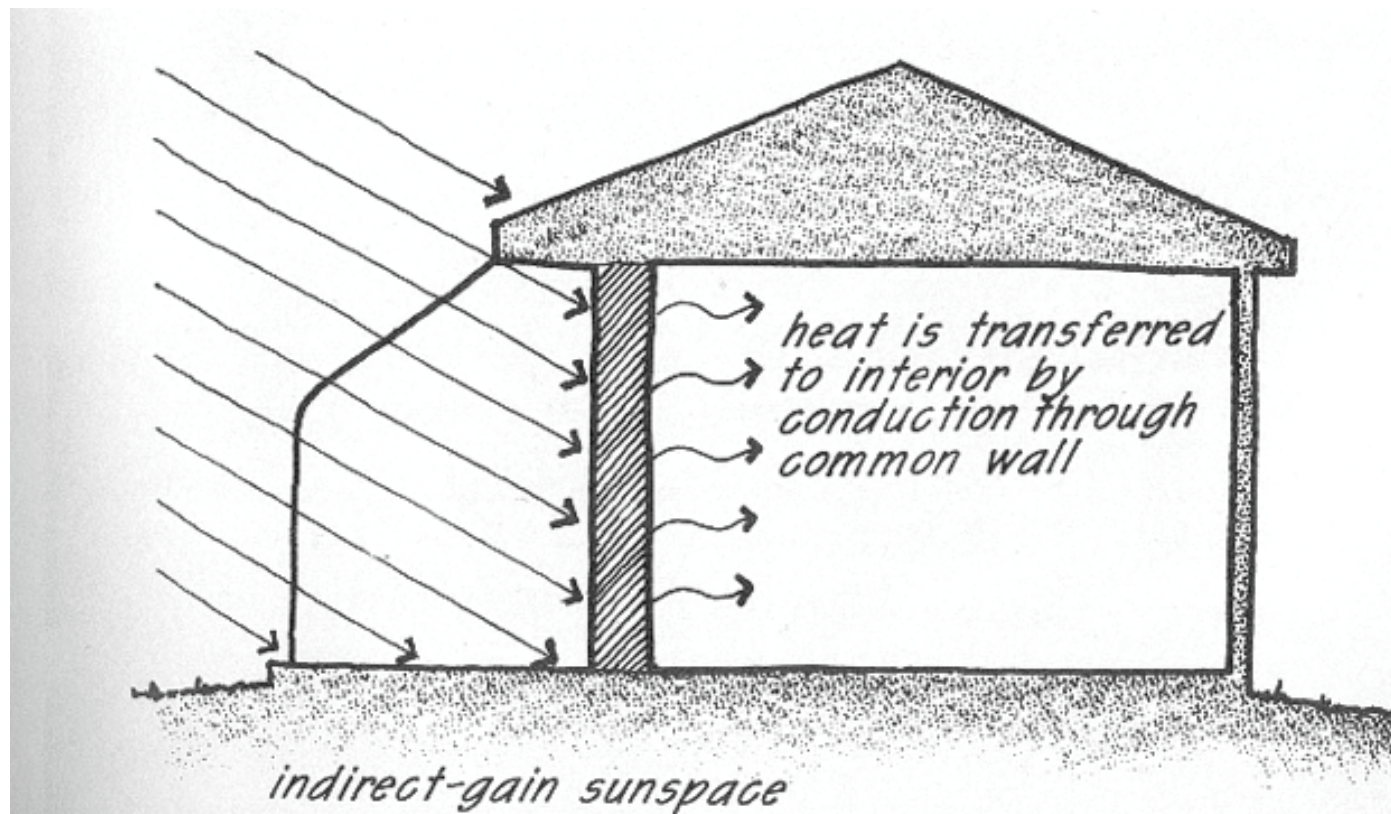

Figure 10.1: Indirect-gain sunspace building with common thermal storage wall. Conduction through the common wall is the primary means of heat transfer to living space.

# Sunspaces:

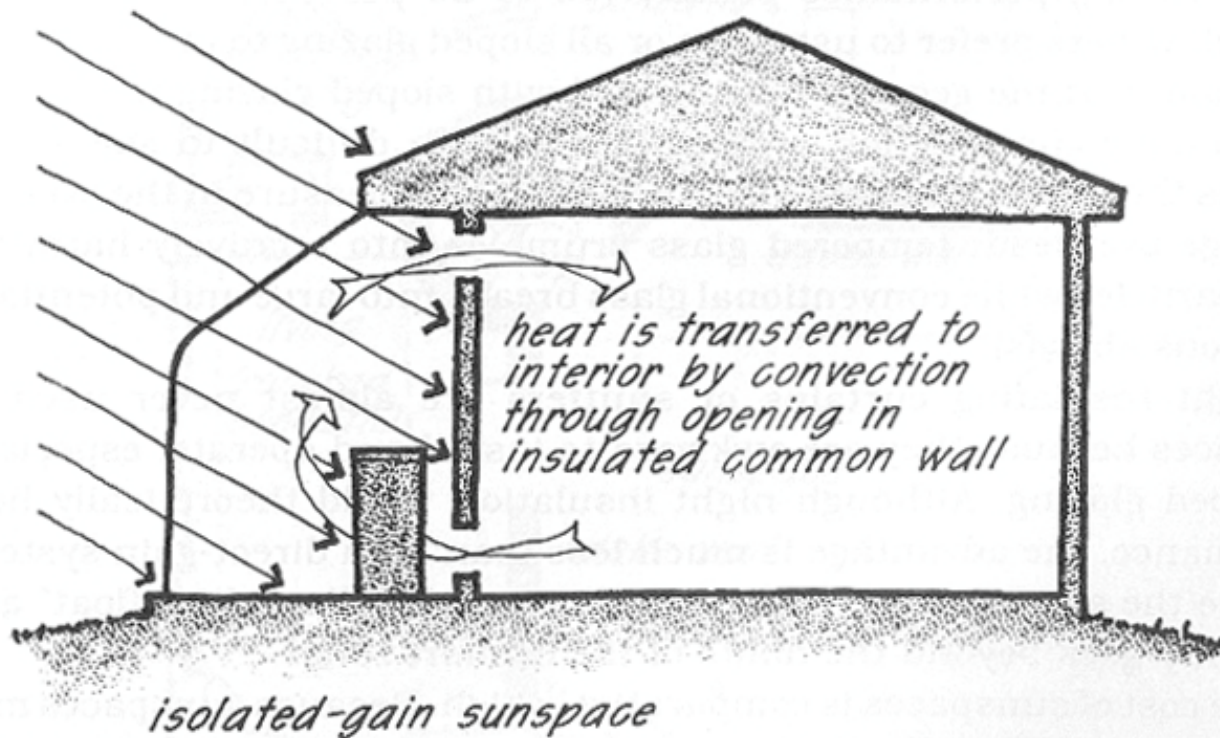

Figure 10.2: Isolated-gain sunspace building with free-standing thermal storage mass and insulated common wall. Convection (either fan-forced or natural) is the primary means of heat transfer to living space.



The glass doors at the center of Iowa's Solar Decathlon 2009 entry enclose a sun space.



The floor of the sun space has thermal mass. Windows in the adjacent walls can be opened to allow the heat to enter.

# Sunspaces:

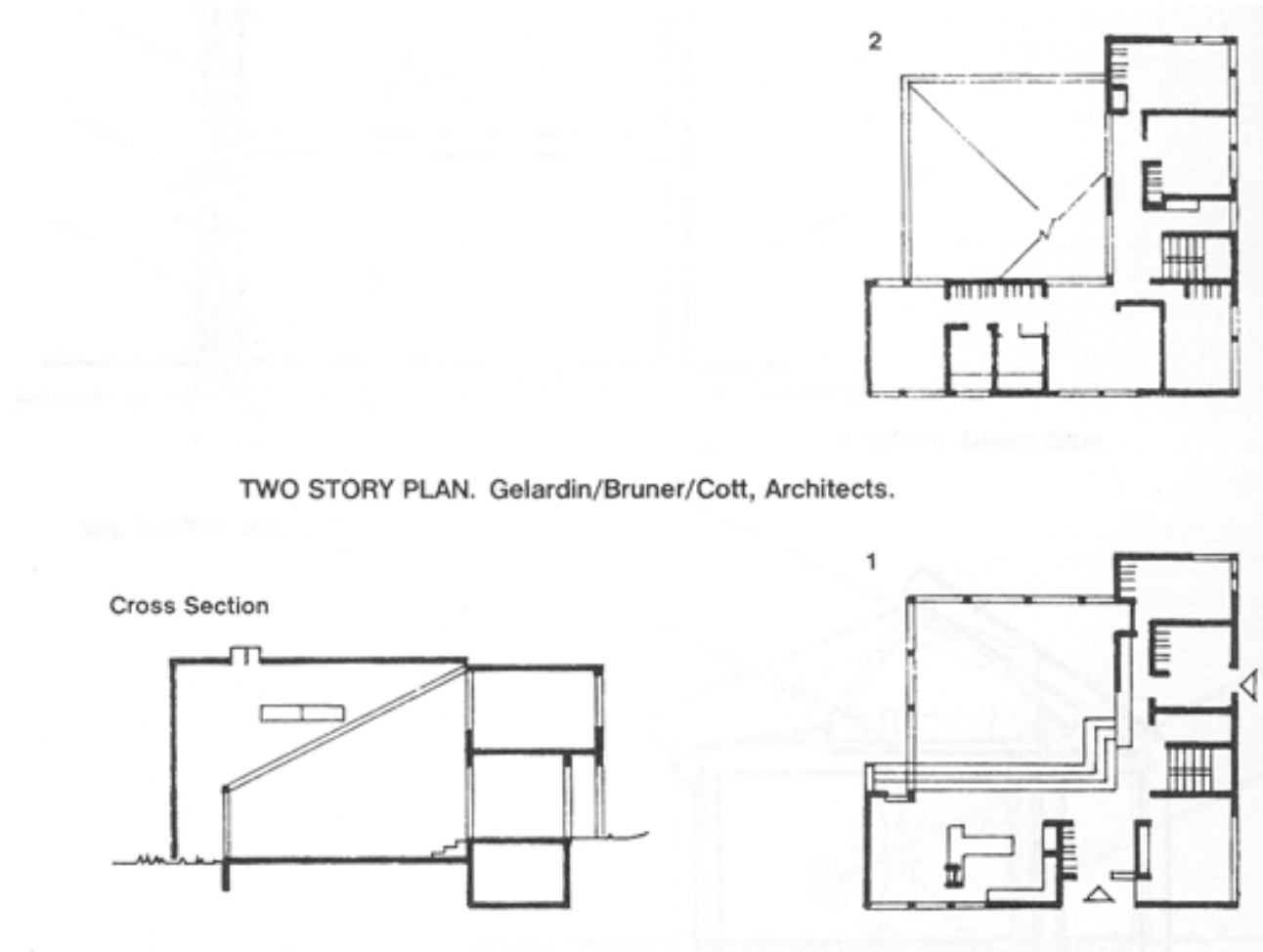
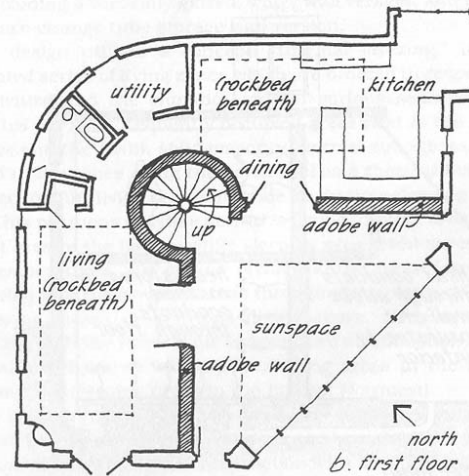
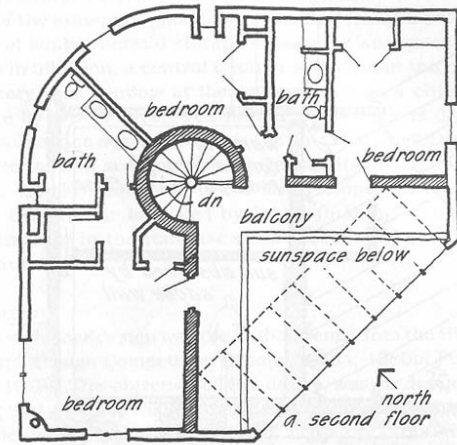

FIG. 20b. In lieu of or in addition to, orienting the majority of living areas for direct solar collection, a single "sunspace" can be used to fully maximize solar collection. Typical examples are attached greenhouses and internal glazed-roofed atria.

# Sunspaces:



HCL



ECS

Figure 10.4: "Unit One" — First Village (a) upper, and (b) lower floor plans. (Redrawn from Howard and Fraker, 1990, by permission.)



# Sunspaces:

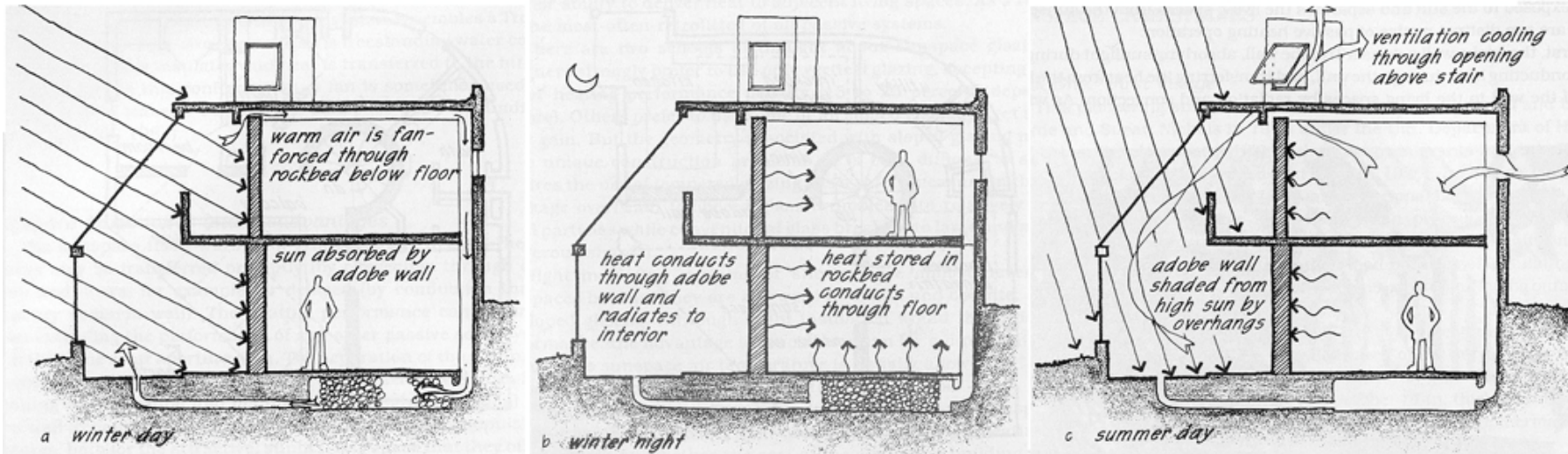

Figure 10.5: "Unit One" passive operation: (a) winter day, and (b) winter night. (Redrawn from Howard and Fraker, 1990, by permission.)

Figure 10.5 (continued): "Unit One" passive operation: (c) summer day. (Redrawn from Howard and Fraker, 1990, by permission.)

# Sunspace Rules:

**ECS** 25. **Effect of orientation:** optimum due south. Penalties about 5% for 30 degrees off due south. More summer overheating for off south directions.

26. **Use of Mass:** increases space's livability. Reduces overheating. Optimum thickness for masonry walls between 8 and 12".

27. **Area of Mass:** direct gain rules apply 3 mass to 1 glazing. If water used,  $0.5\text{ft}^3/\text{f}^2$  of glass. Water containers dark coloured and located in the sun.

28. **Water Container Shape:** The one that allows the greatest volume to be placed. Size not too important.

29. **Do not glaze end walls:** for both summer and winter performance.

# Sunspace Rules, cont'd:

ECS

30. **Roof:** Need to be able to shade it in the summer to avoid overheating. Curtain, awnings or internal shades, OK.

31. **Common Wall:** Needs to be able to be closed off from main living space to avoid overheating. Preferably masonry (like trombe wall).

32. **Common wall vents:** required as one of the ways heat is transferred to the living space.

a. doorways, 15% of glazing area

b. window openings, 20% of glazing area

c. high and low vent pairs, 10% of glazing area



Iowa's sun space can be closed off.

# Sunspace Rules, cont'd:

- ECS** 33. **Summer Venting:** needs to be vented during summer especially if not well shaded.
- 34. **Wall Colour:** Direct gain rules apply, except:
  - a. use darker colours in general as light colours tend to reflect light and heat out of the space
  - b. if used as a green house, surfaces in corners need to be light to improve plant performance/life.
- 35. **Sunspace width:** 15 to 20 feet works well.
- 36. **Colour:** dark colours work better to absorb heat.
- 37. **Plants and other lightweight objects:** Limit.







At the YMCA Solarium Building, the sunspace is used to house the Living Machine, and the heat caught in this space pumped to other portions of the building to heat them.







# What is a Convective Air Loop??

**Convective Air Loop** -- a passive solar heating system that consists of a solar collector and a thermal storage mass (usually a rockbed) isolated from the living spaces. Air is used to transfer heat from the collector to the storage and the living spaces.

**Hybrid System** -- A predominantly passive solar heating system which utilizes an active component, such as a fan, to force heat from one location to another.

**Rockbed** -- a heat storage component consisting of an enclosed volume of rocks (fist-sized) with a plenum at each end. During the charging cycle, warm air from the solar collector is circulated through the rocks, warming them. During the discharge cycle, cool room air is circulated through the rocks where it is heated and returned to the room.



# Rockbeds:

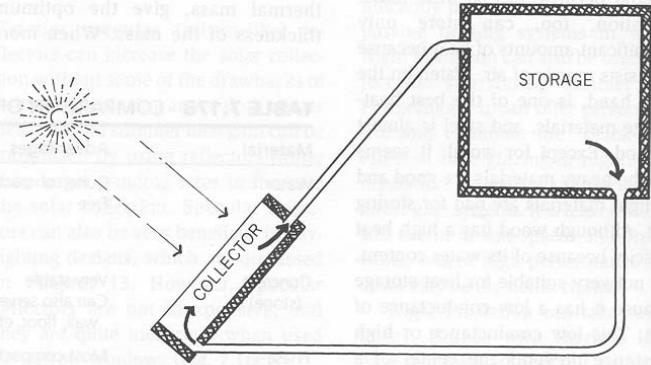

Figure 7.18a The convective loop (thermosiphon) system requires the storage to be above the collector.

HCL

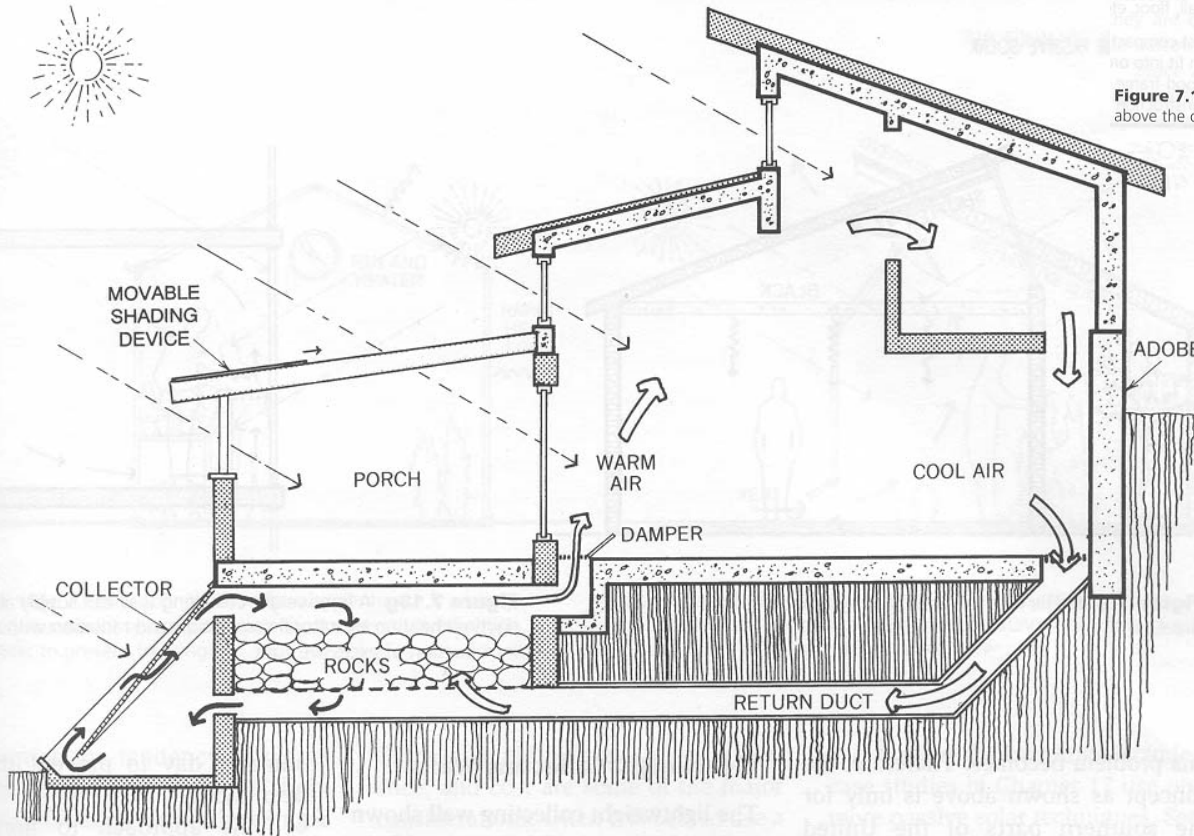

Figure 7.18b A convective loop heats the rock bed in the Davis house, New Mexico, designed by Steve Baer.

# Rockbeds:

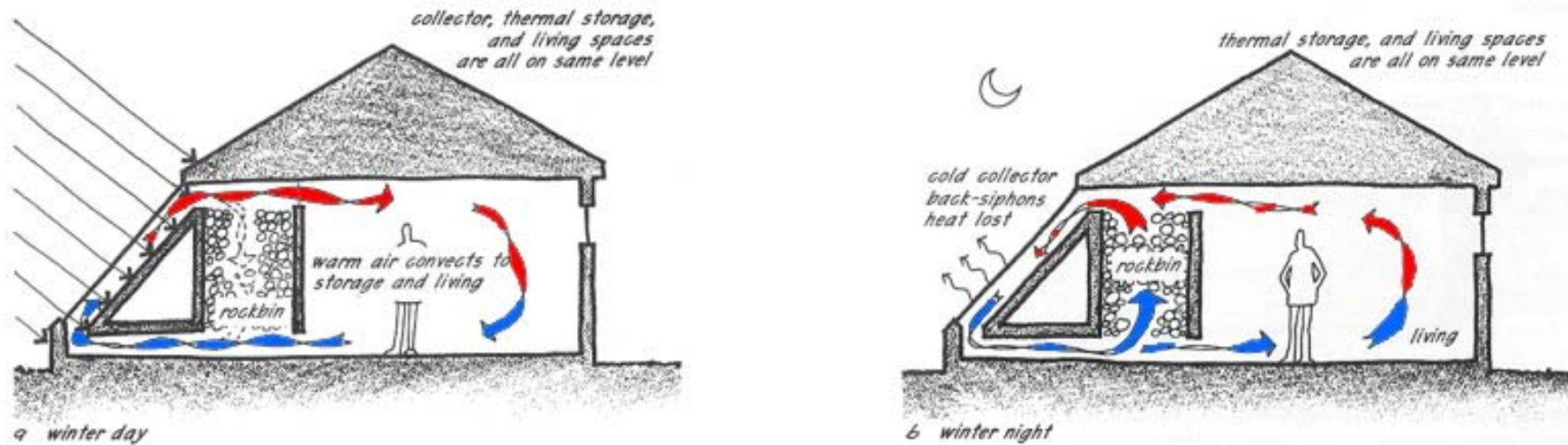

Figure 11.1: Positioning the collector, storage, and living areas at the same level in a convective air loop system: (a) winter day operation — level arrangement allows convective heating to occur during the day; (b) winter night operation — this "level" positioning of components permits unwanted back-siphoning, effectively cooling the system.

# Rockbeds:

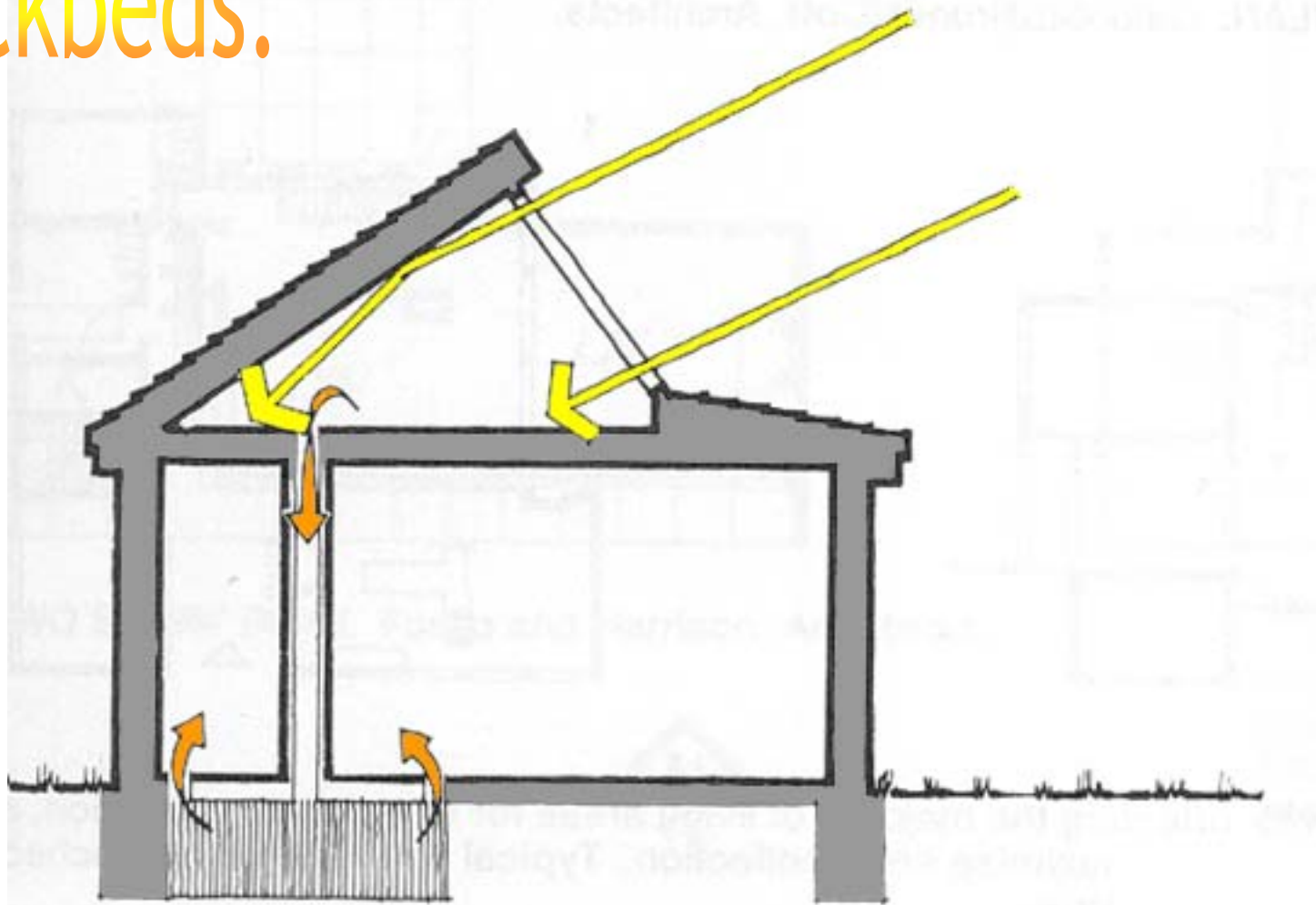
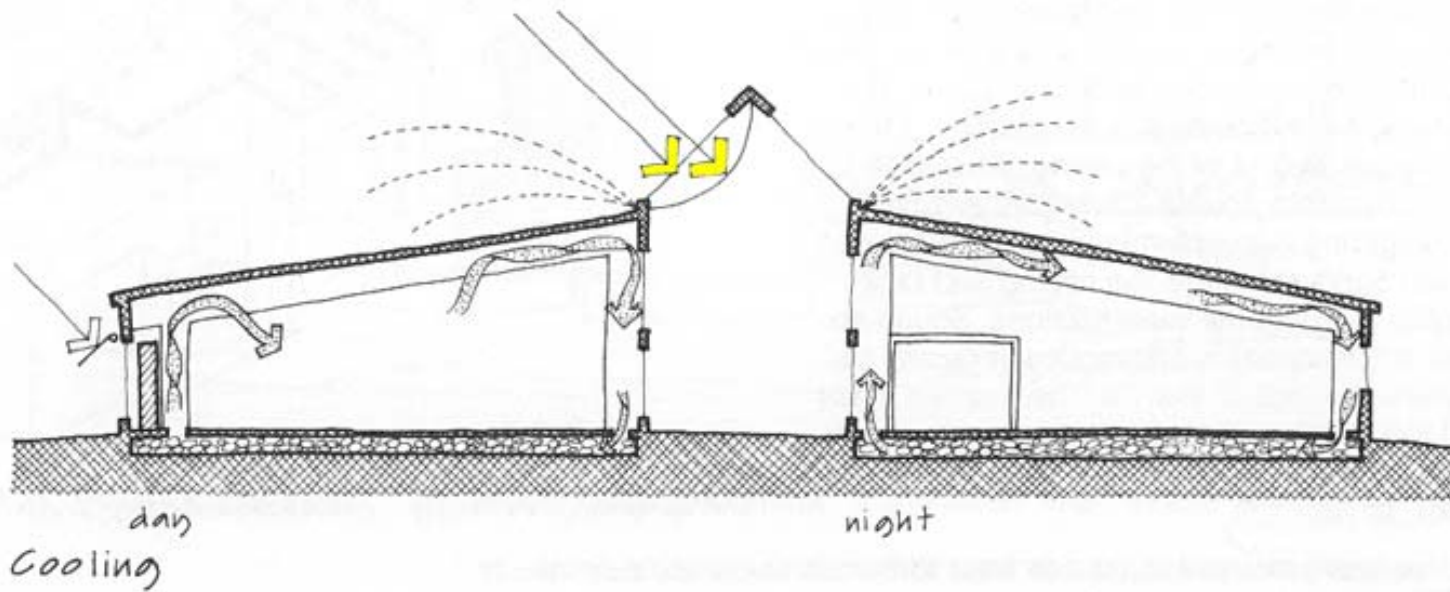
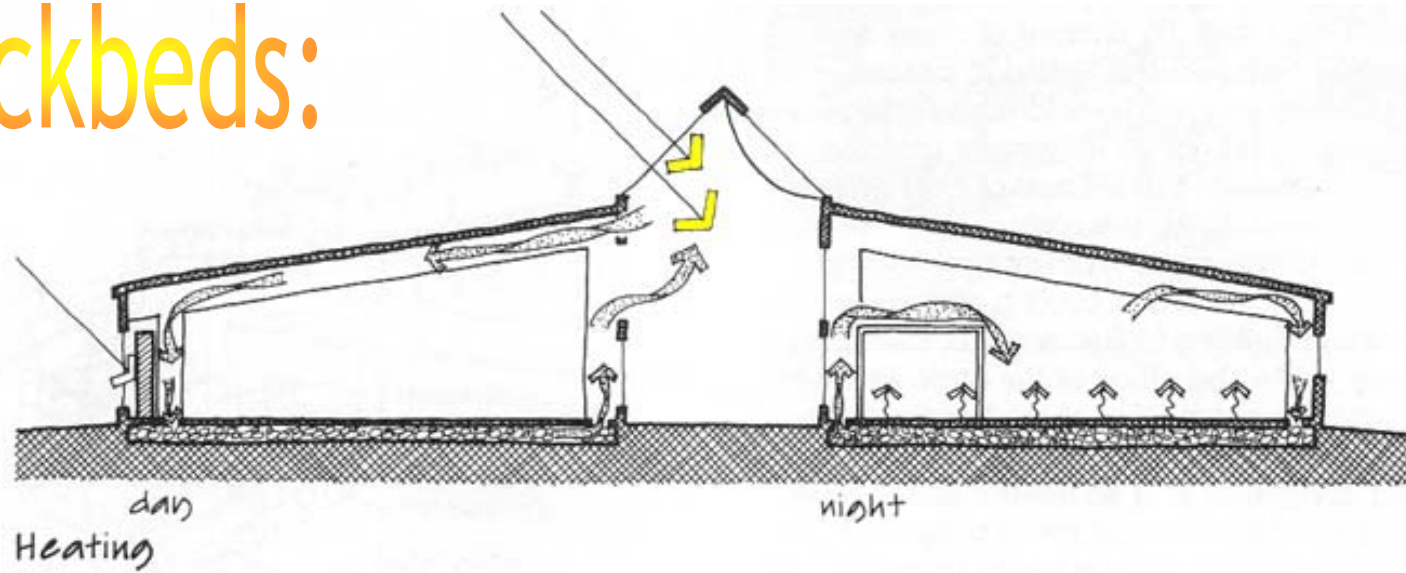

FIG. 19e. Remote Gain and Storage



# Rockbeds:



SWL



# Rockbeds:

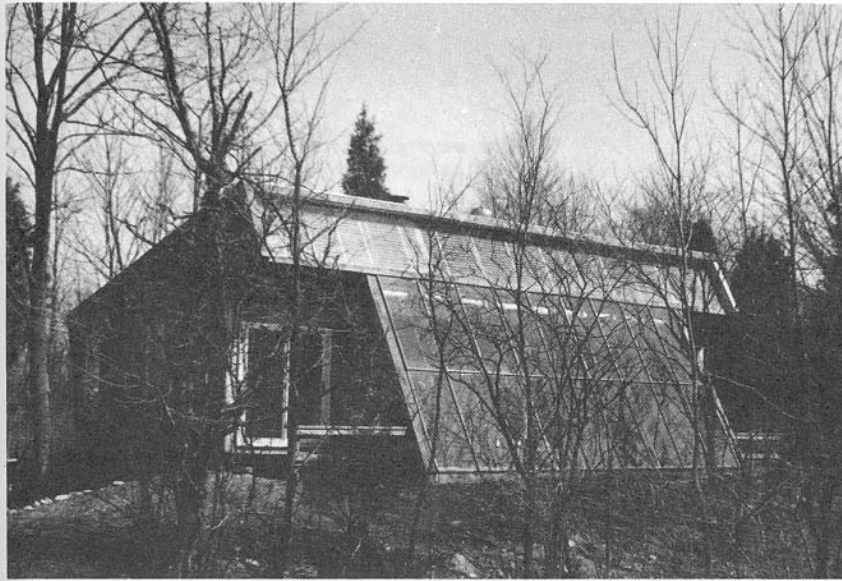

Figure 10.6: Solargreen exterior showing south-facing sunspace.

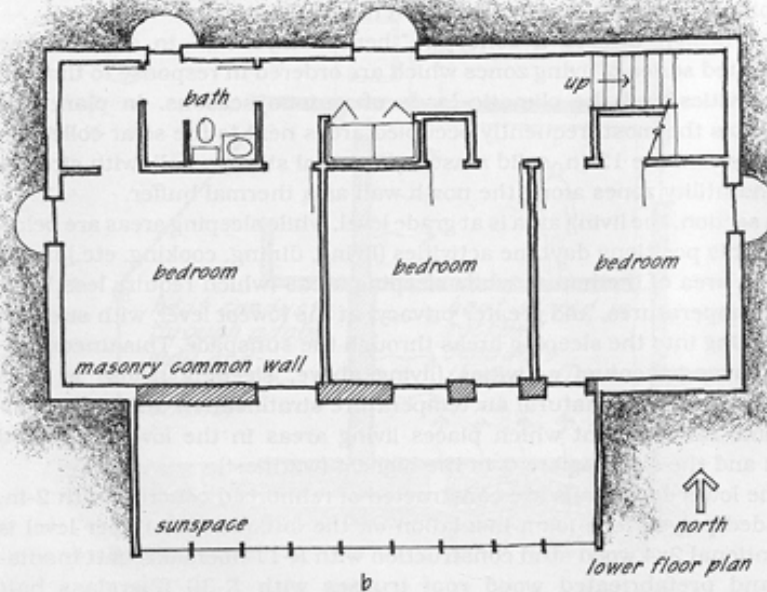
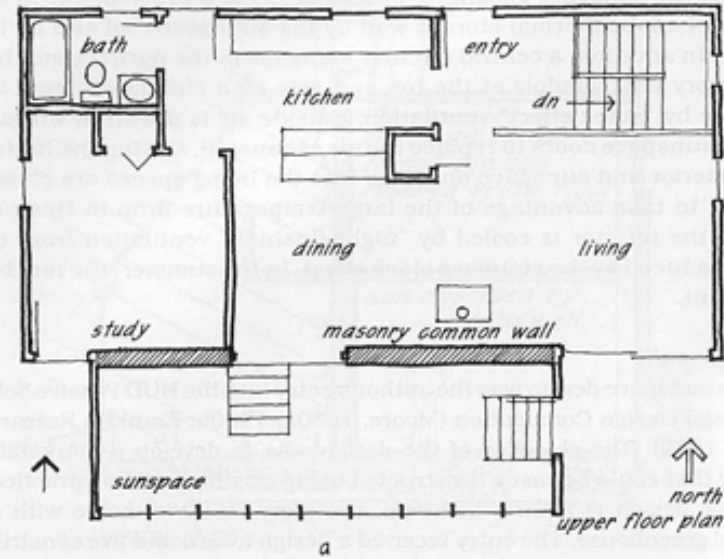
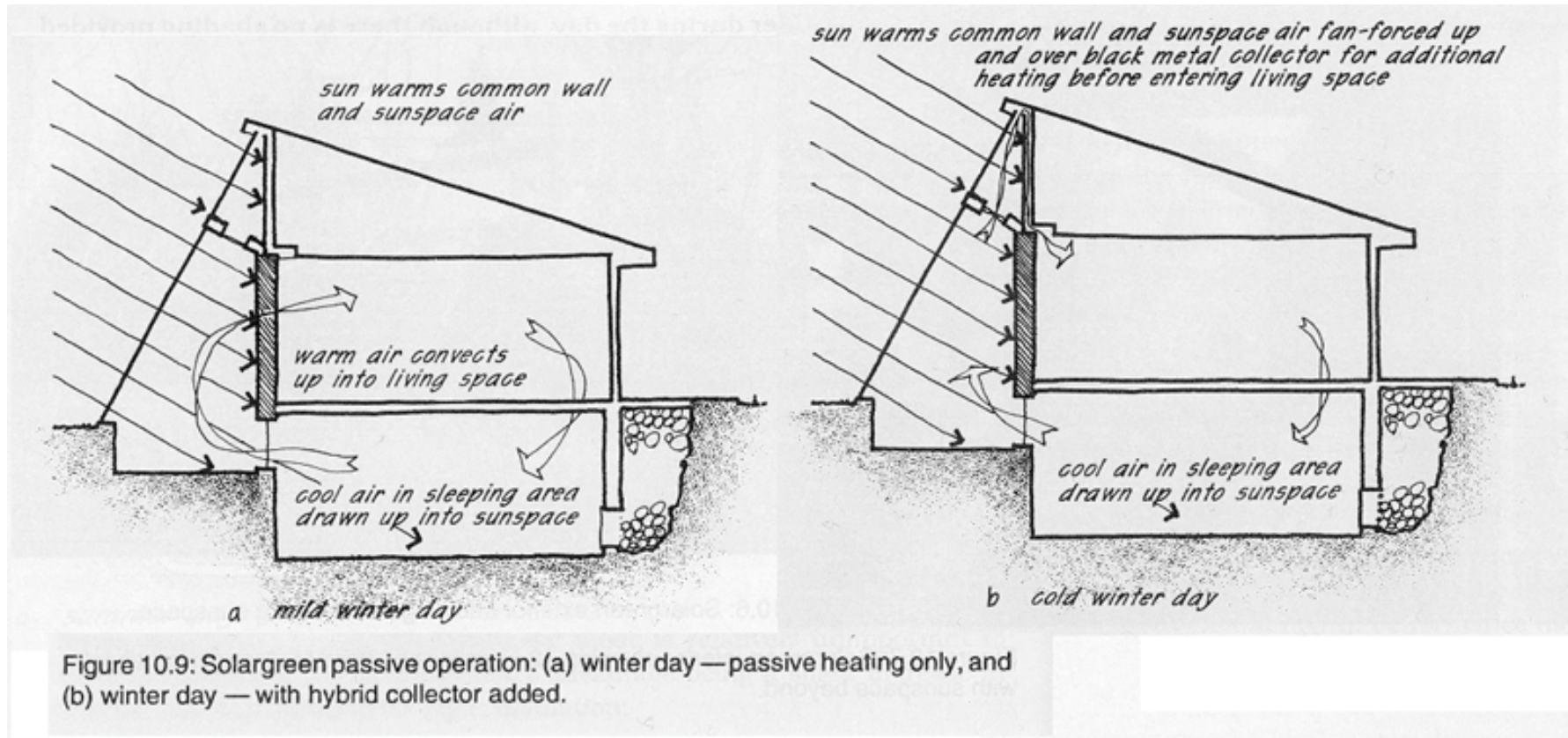

Figure 10.8: Solargreen floor plans: (a) upper level, and (b) lower level.

# Rockbeds:





# Rockbeds:

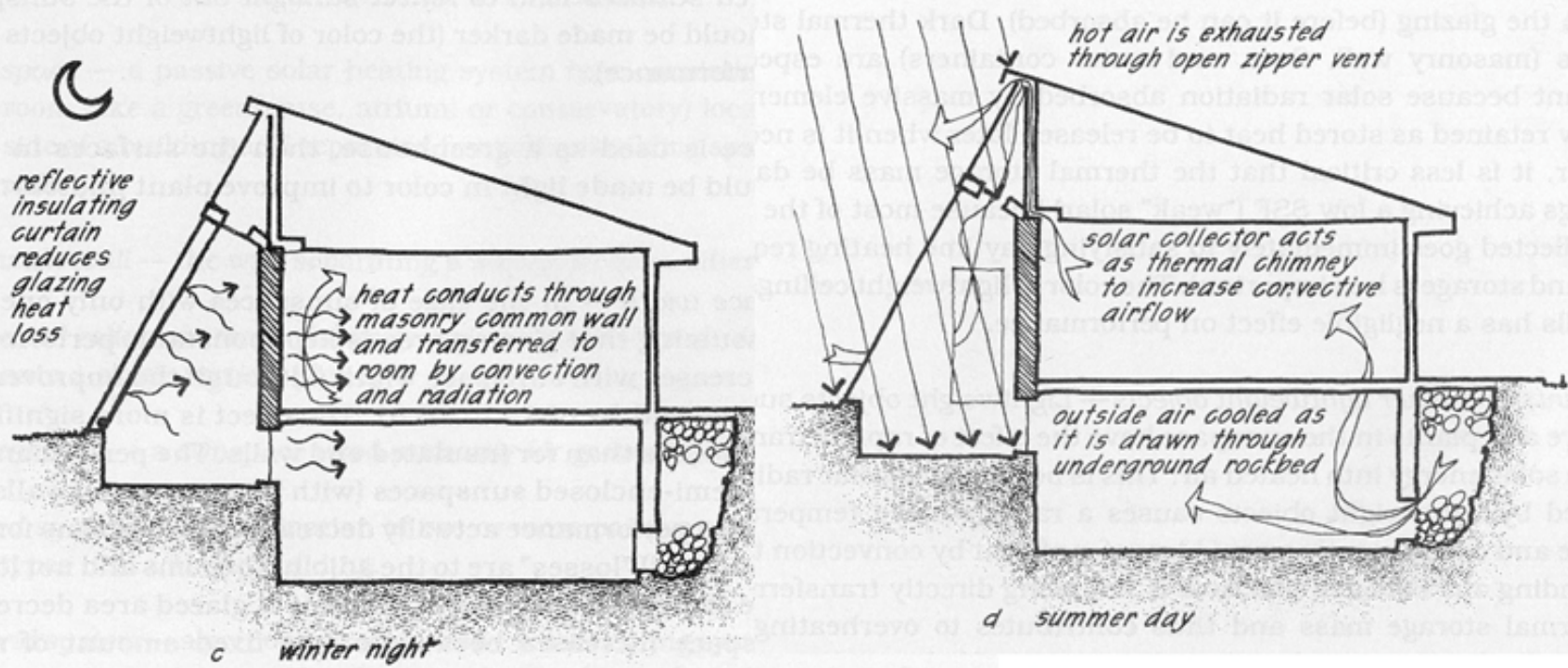

Figure 10.9 (continued): Solargreen passive operation: (c) winter night, and (d) summer day.

Examples!



# Examples:

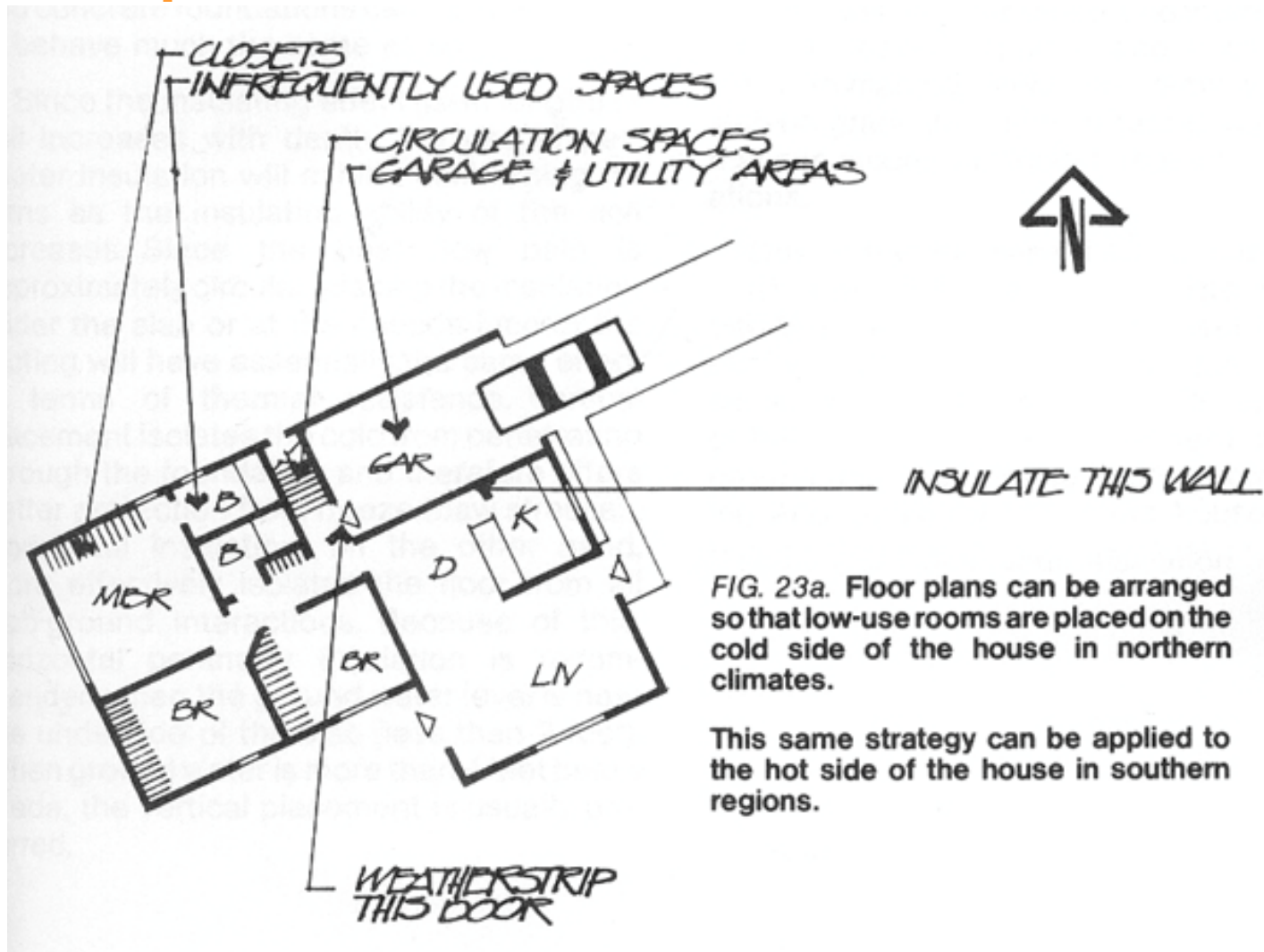

FIG. 23a. Floor plans can be arranged so that low-use rooms are placed on the cold side of the house in northern climates.

This same strategy can be applied to the hot side of the house in southern regions.

# Examples:

GARAGE AND HALL PROVIDE BUFFER FROM COLD NORTH SIDE. THIS PLAN, IN TURN, IS WELL SUITED TO BERMING OR TUCKING INTO A SLOPE.

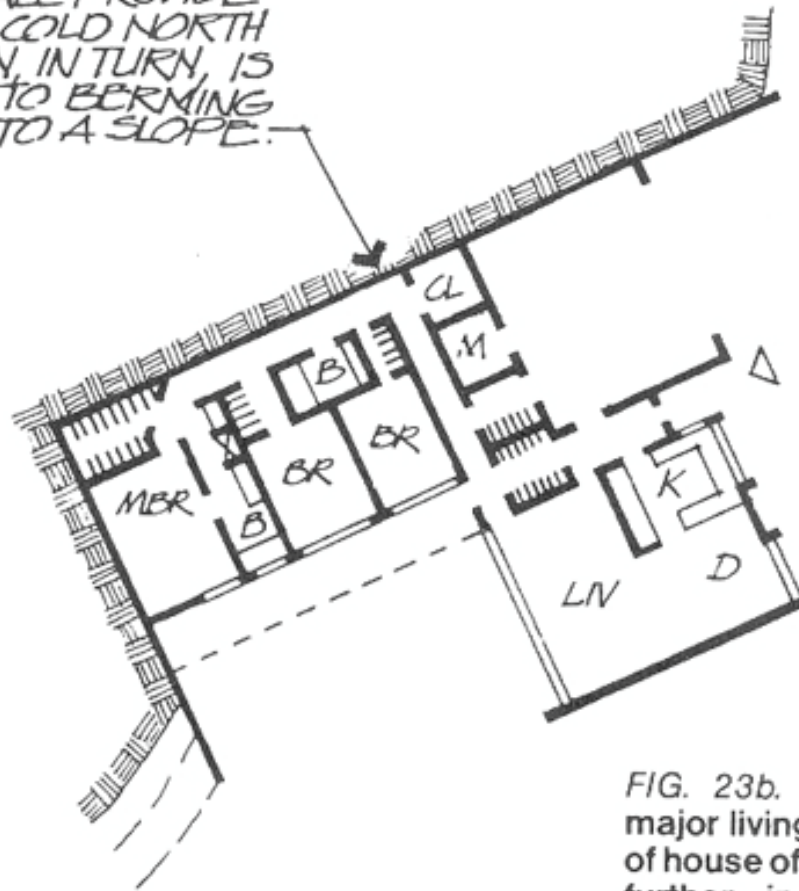
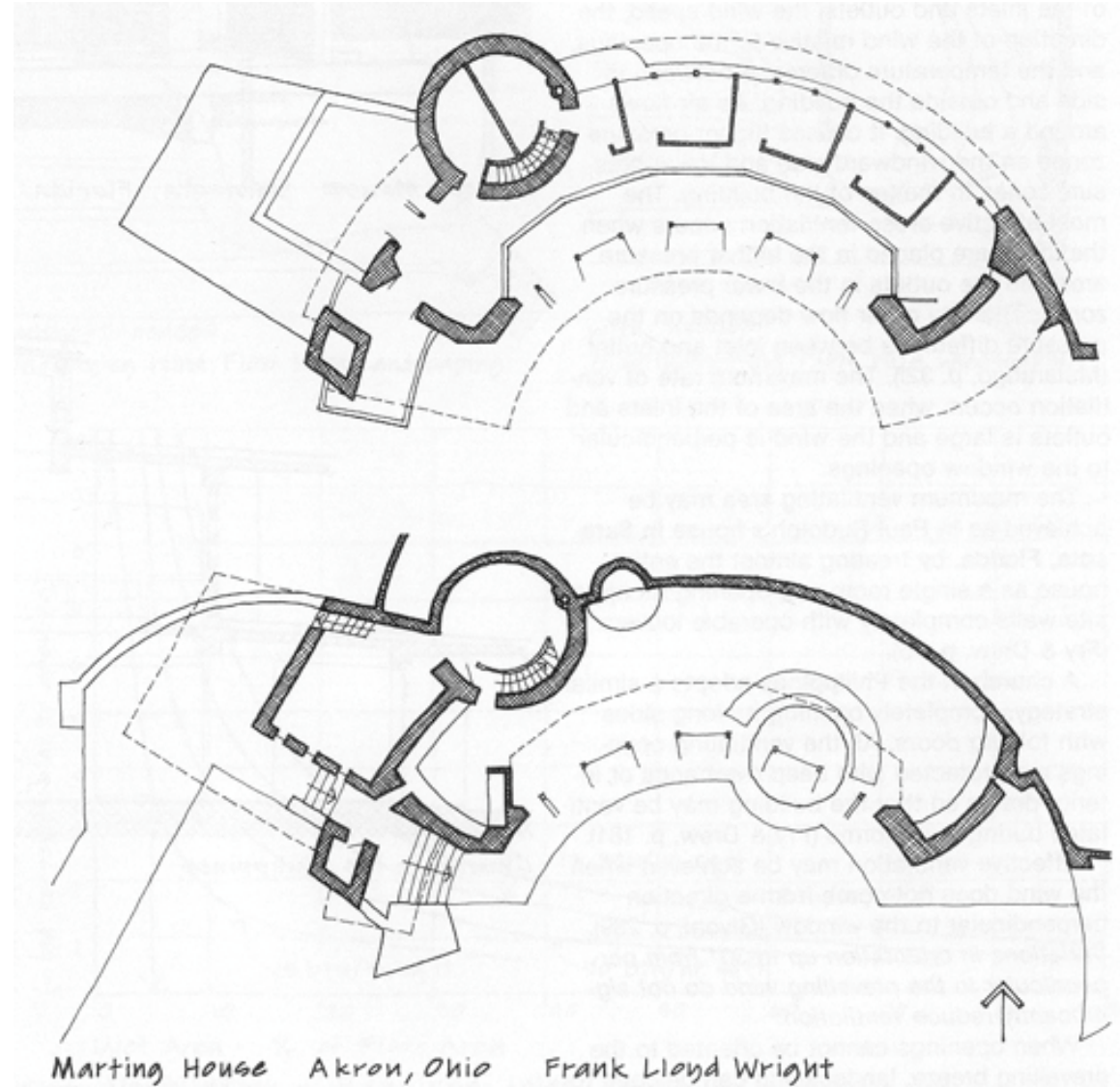
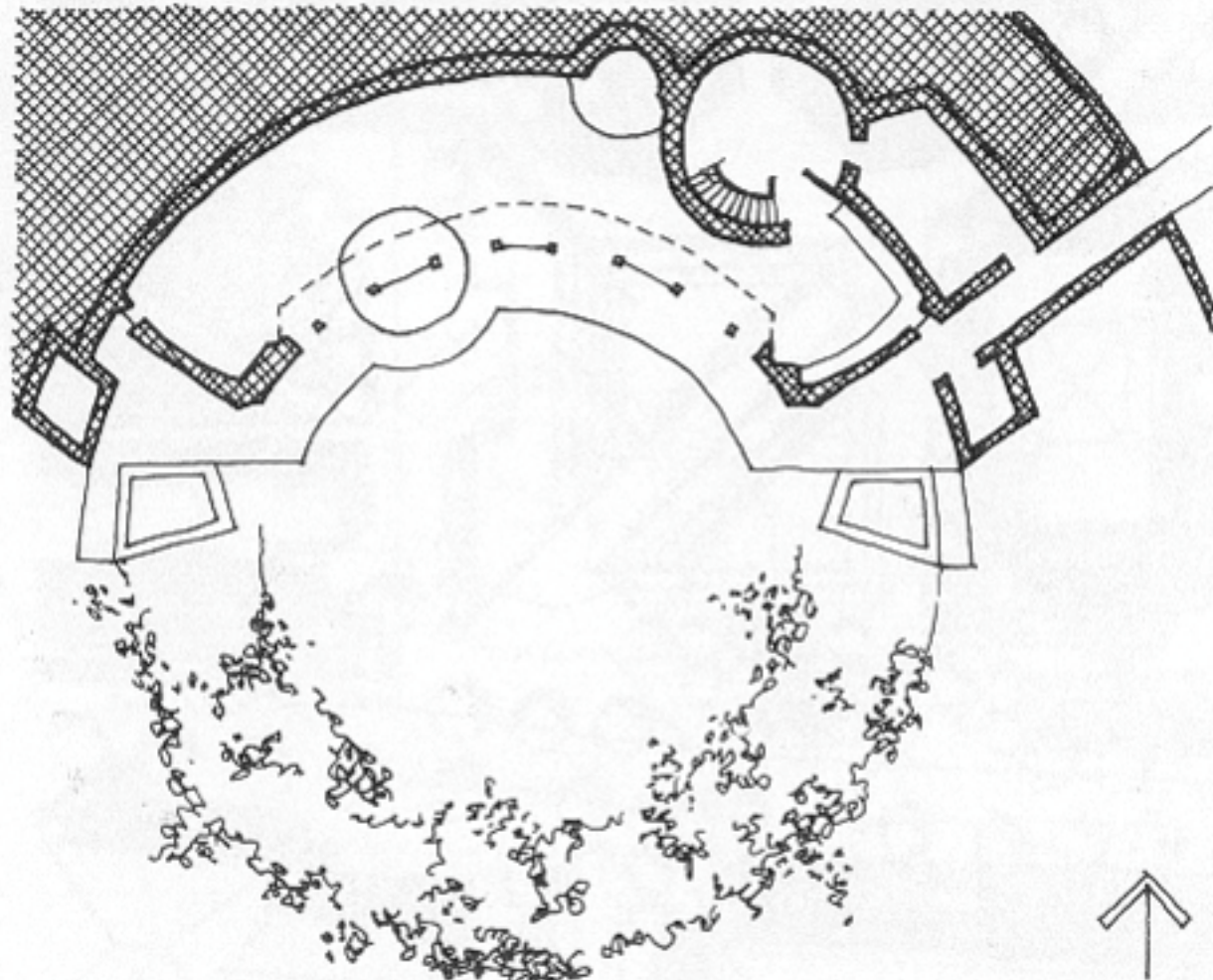

FIG. 23b. Internal zoning to remove major living areas from the "cold" side of house often suggests going one step further—in this case, burying the windward wall altogether.

# Examples:





Jacobs II House Middleton, Wisconsin  
F.L. Wright

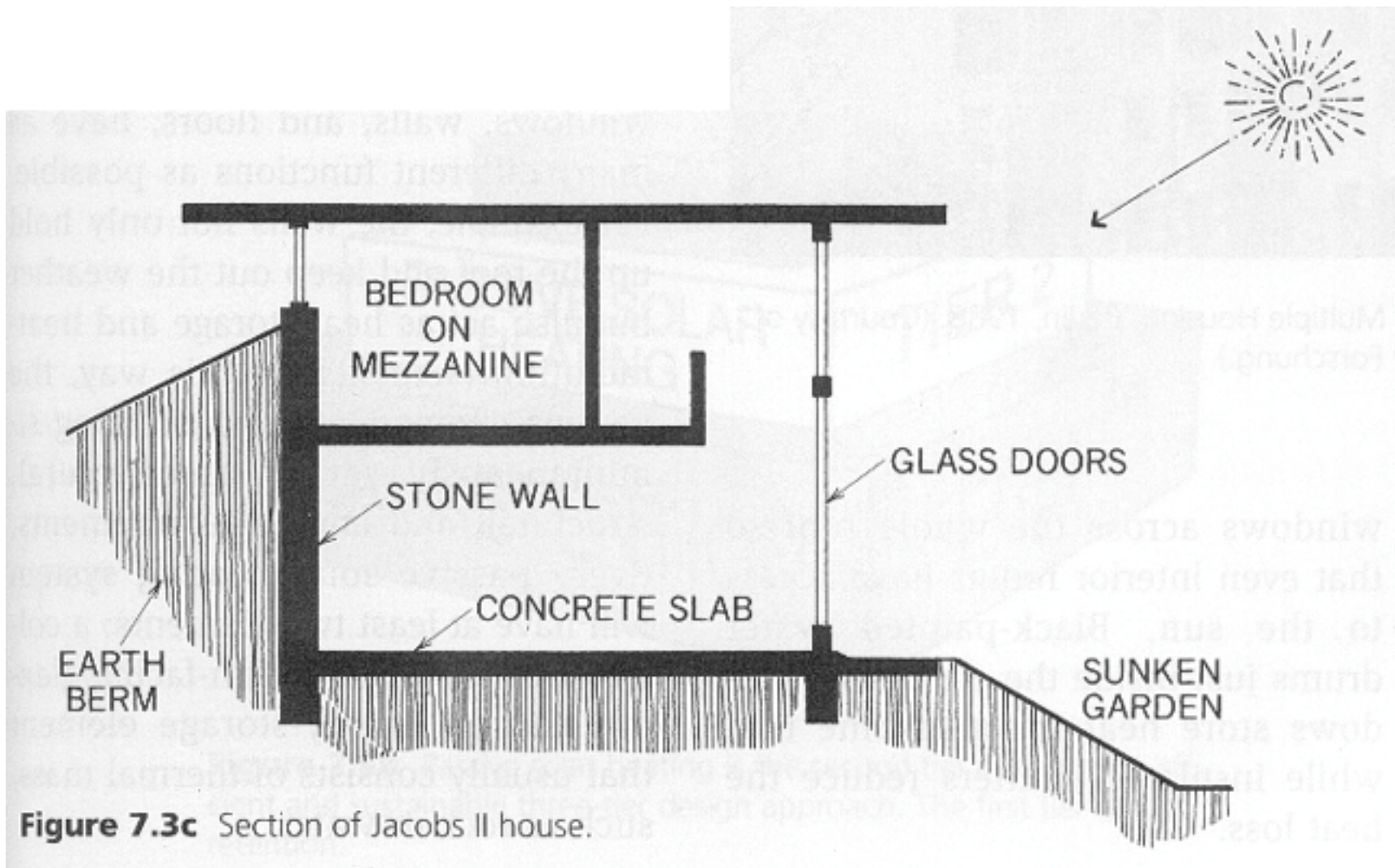

**Figure 7.3c** Section of Jacobs II house.



**Figure 7.3a** The Jacobs II House, Architect, Frank Lloyd Wright, Madison, WI circa 1948. (Photograph by Ezra Stoller © Esto.)

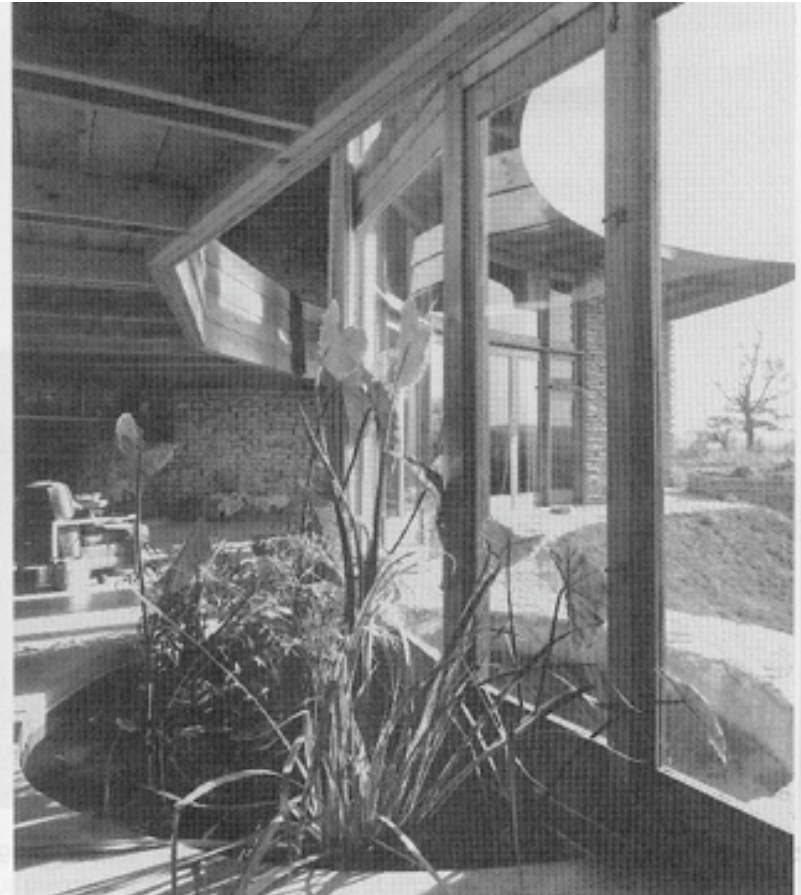

**Figure 7.3d** Interior view of Jacobs II House. (Photograph by Ezra Stoller © Esto.)



# Examples:

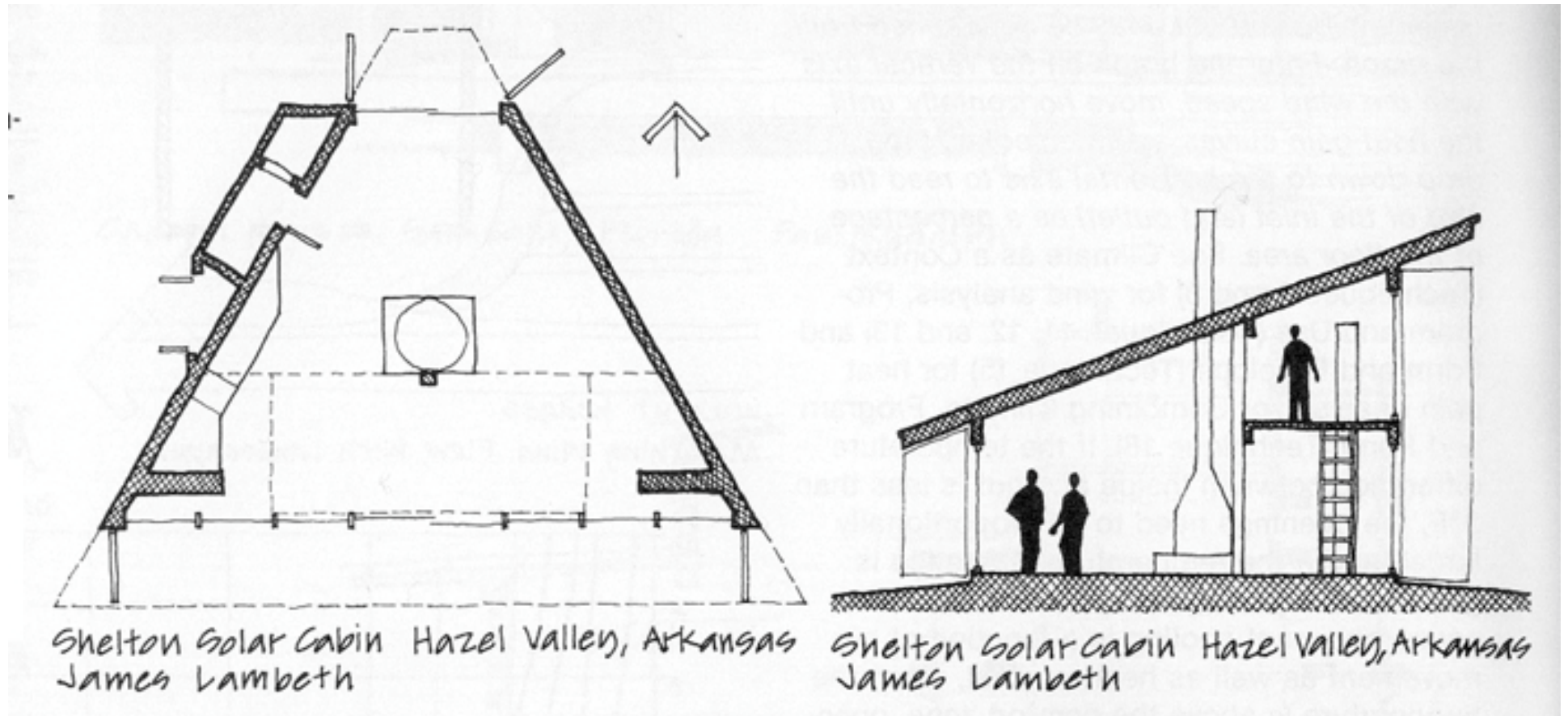

SWL

# Examples:

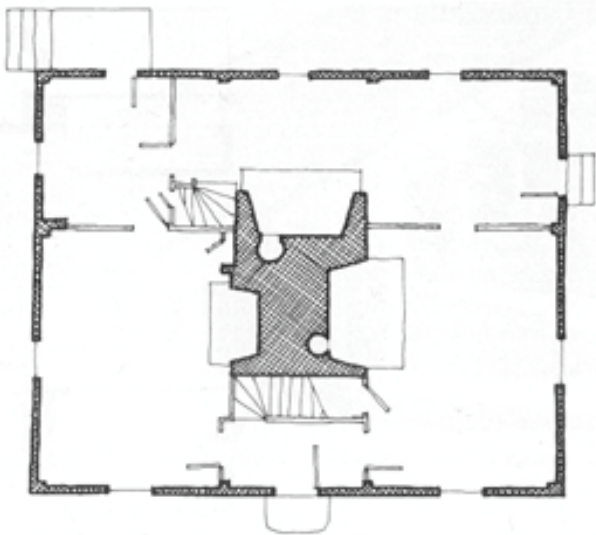

Old Ogden House Fairfield, Conn.



Old Ogden House Fairfield, Conn.

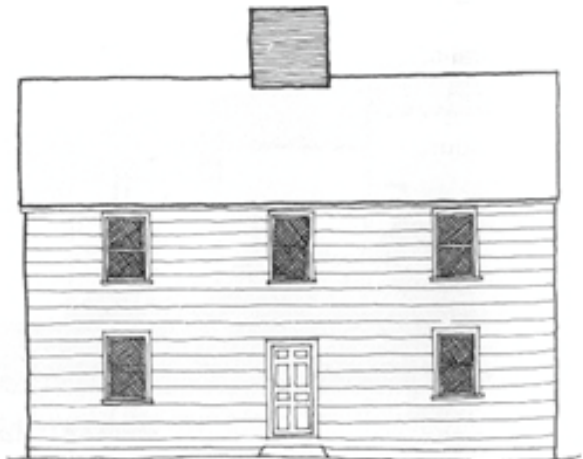

Old Ogden House Fairfield, Conn.

SWL

Use of central mass as a heating element. Same idea used in YMCA Environmental Learning Centre with masonry heating unit.

# Examples:

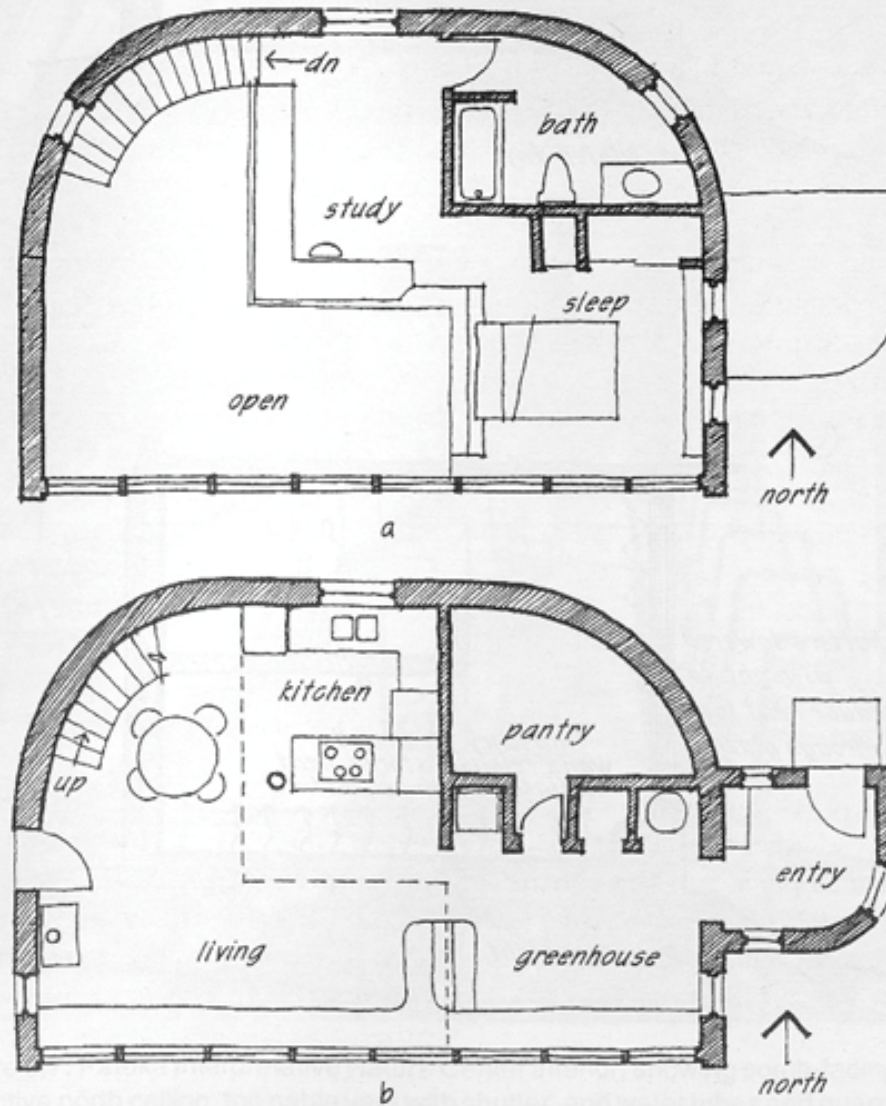

Figure 8.3: David Wright's residence: (a) upper plan, and (b) lower plan. (After Wright, 1976.)

## Klosterenga: Ecological housing in an urban environment





**KLOSTERENGA • TEKNISKE SYSTEMER**  
 ARKITEKTKONTORET GASA AS, ARKITEKTSKAP AS

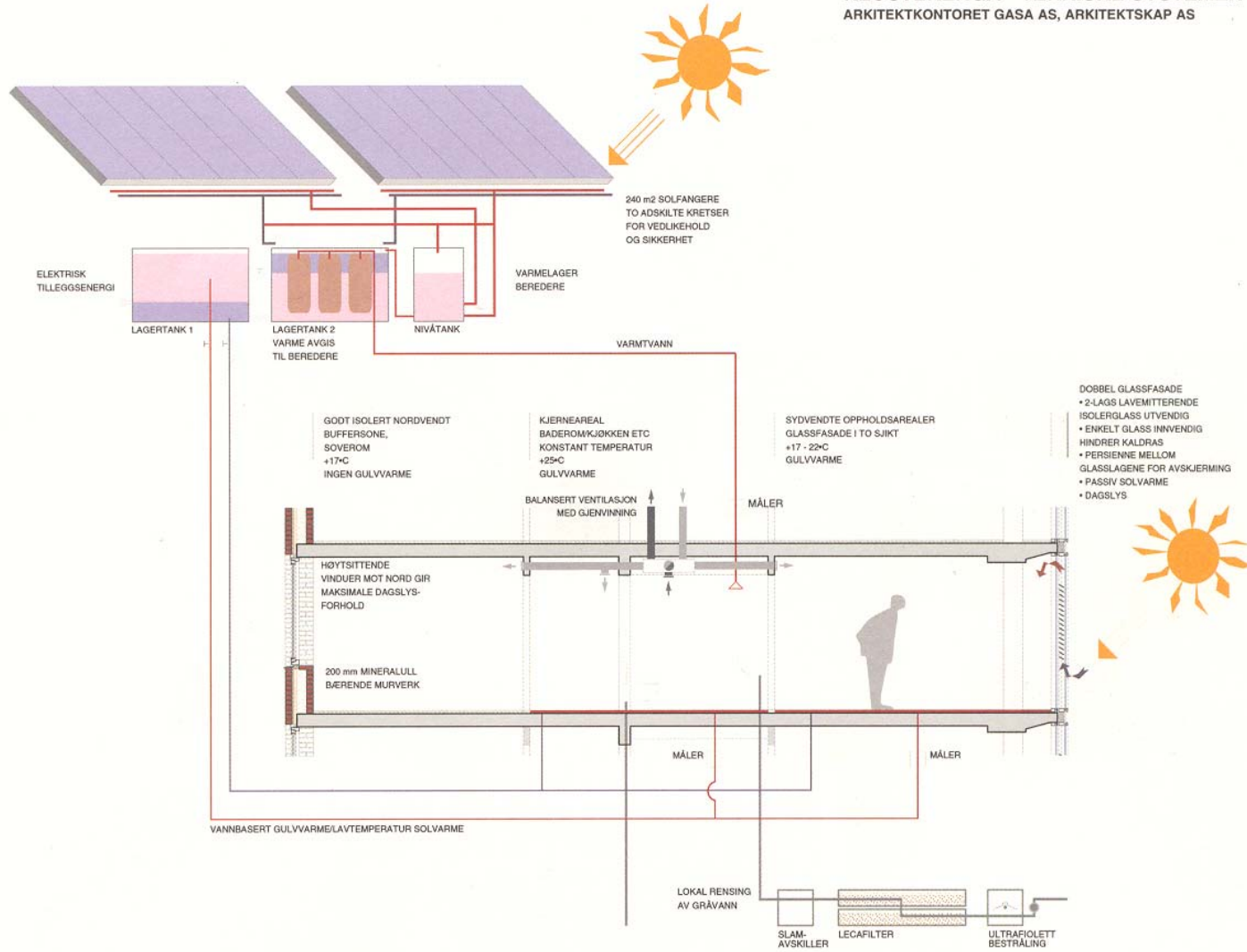

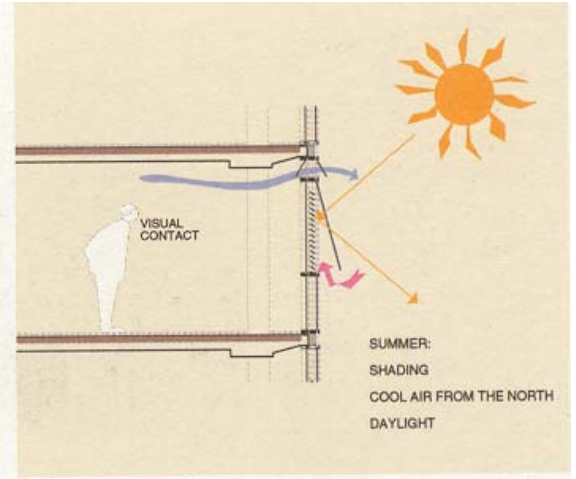
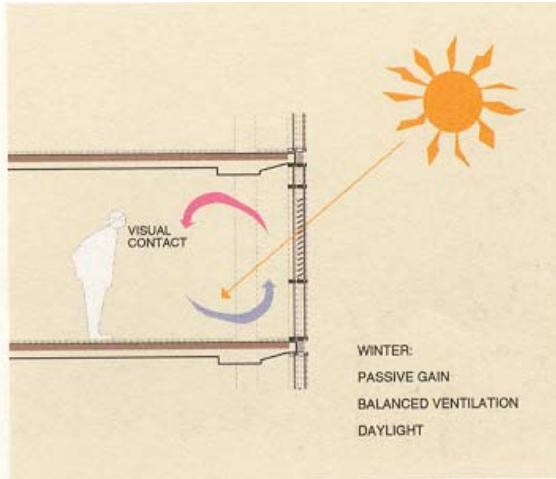
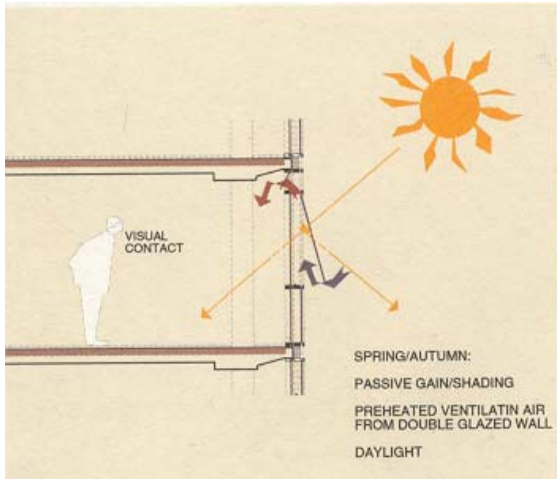

# Comprehensive Retrofit of Apartment Buildings with Emphasis on Solar Energy

## Gårdsten Estate, Göteborg, Sweden

The Gårdsten is a large Swedish housing estate built in the 1970s.

As the physical condition and social environment of the buildings had deteriorated considerably over the years, a comprehensive refurbishment is underway for 255 of the 1000 apartments in the estate. (A less comprehensive renovation is planned for the remaining apartments.)

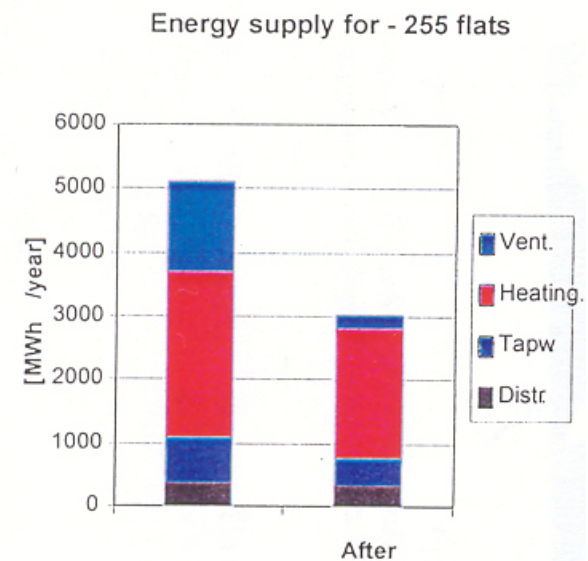
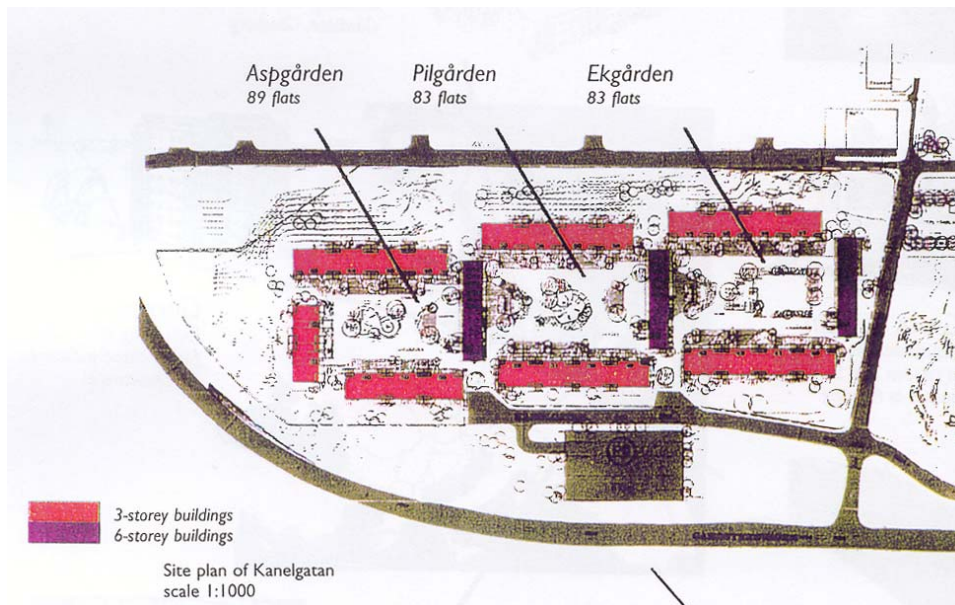



# Gardesten Solar House Project – Gothenburg

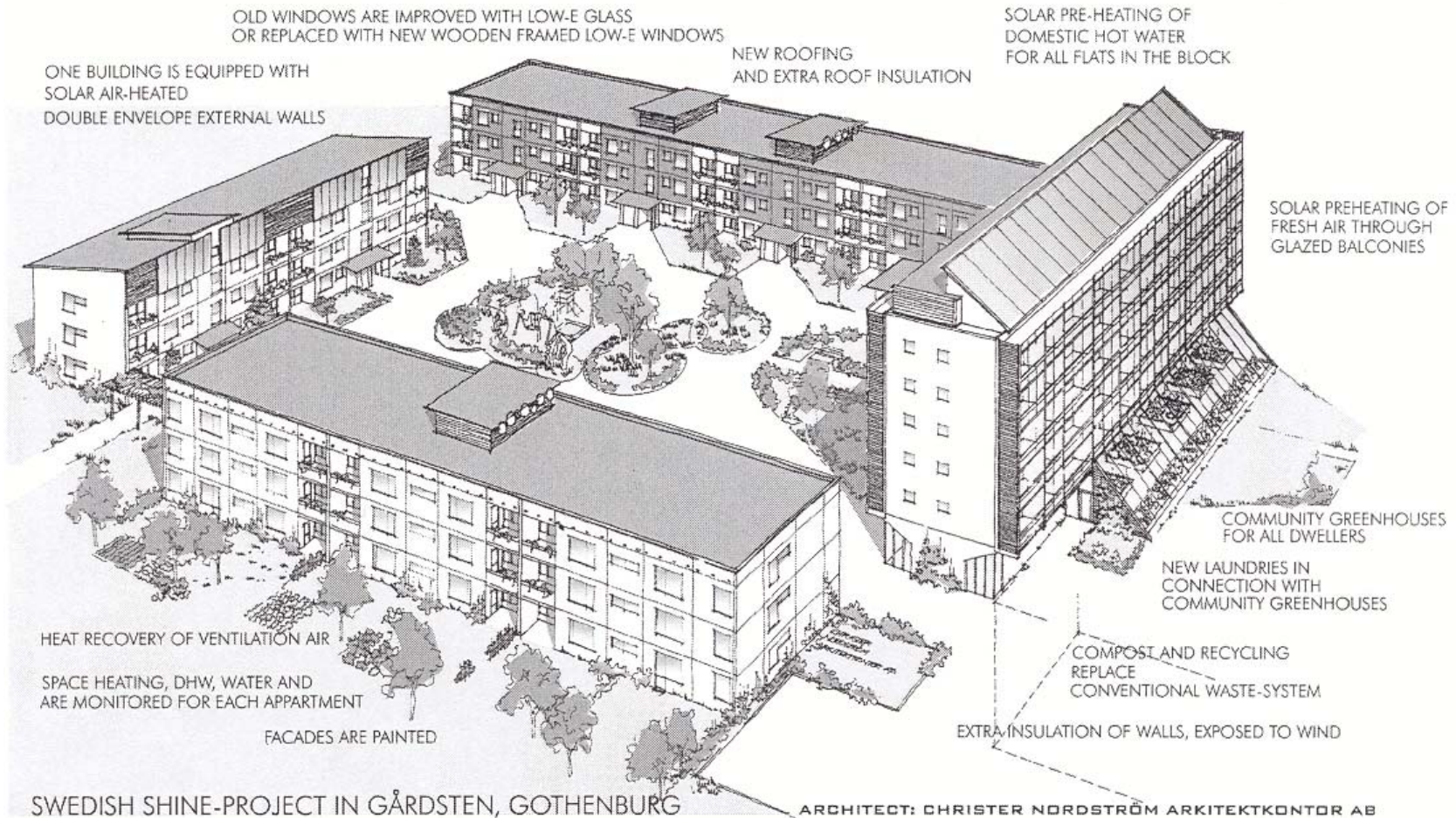

*Top: birdview of one of three similar blocks describing the solar- and sustainable technologies.*

## Gardesten Solar House Project – Gothenburg

### On the high-rise (five-six storey) buildings:

- the flat roof is rebuilt with a new, inclined roof with integrated solar panels for heating domestic water. The solar panels are designed as roof modules, i.e. they are both a roof and a collector mounted directly on the roof trusses.
- the basement supply air system was removed and replaced with air intake via newly-glazed south-facing balconies. "Brush sealing" were designed for windows and balcony doors.
- the exhaust ventilation is operated with a minimum flow depending on outside air temperature.

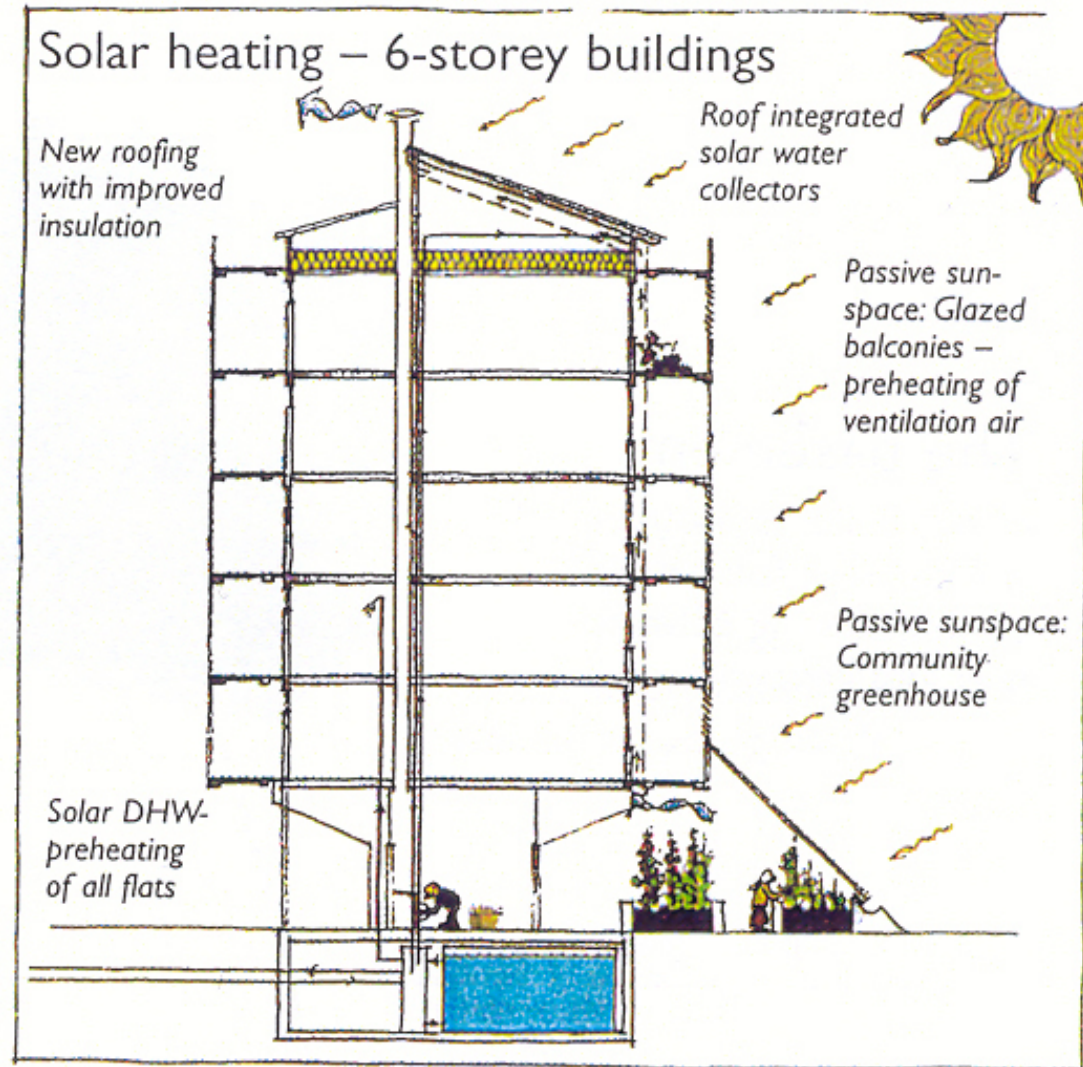

## On the low rise (three-storey) buildings

- new roof covers and additional insulation improve the thermal insulation of the existing air supply ducts, which are situated close to the roof cover.
- the south facing low rise building is equipped with solar air collectors facing south and a double envelope wall on facades facing east, west and north. The solar heated air is circulated in an air gap between the new insulated envelope and the old façade.
- low rise buildings are supplied with solar heated hot water from the collectors on the high-rise buildings.
- the edges of the floor slabs are insulated to improve thermal comfort on the ground floor.
- new heat recovery ventilators (HRVs) are installed in the staircase-entry buildings.

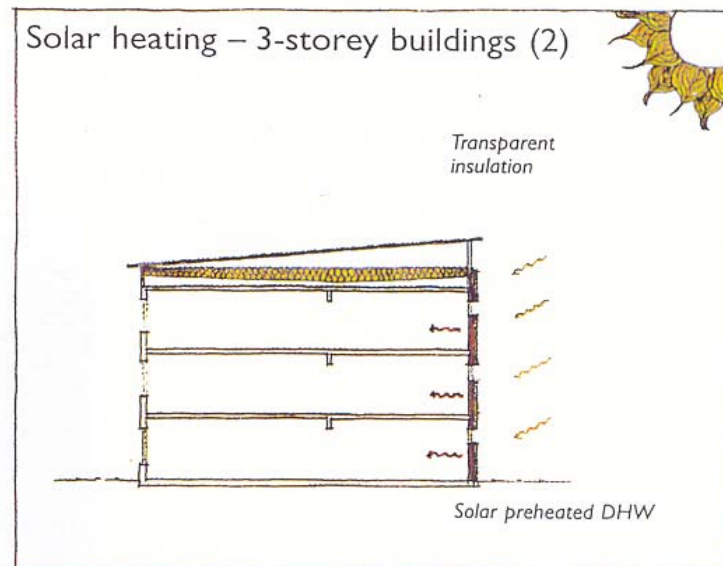
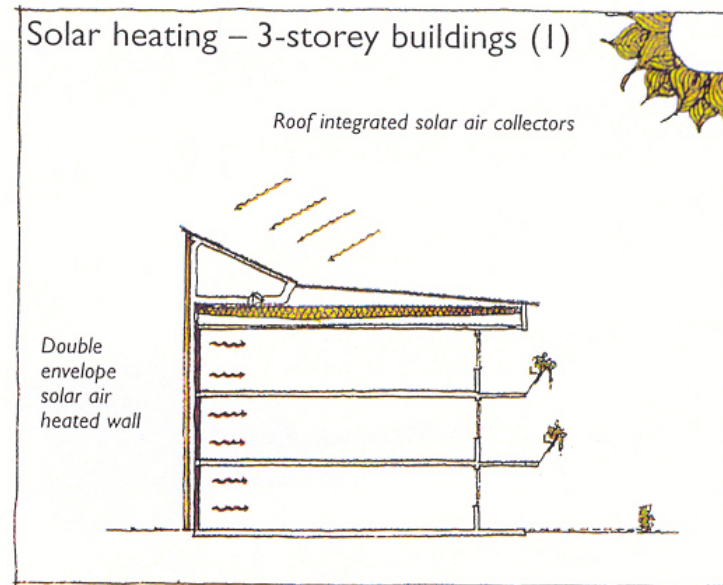

## Gardesten Solar House Project – Gothenburg







## 20 Houses without Heating System - Gothenburg



### Houses without Heating Systems

20 low energy terrace houses in Göteborg



The total energy use is about 6000 kWh/year, which is more than half of what is normal for such a house. And at the same time are the indoor conditions satisfactory and can be compared with houses with traditional heating solutions.



## 20 Houses without Heating System - Gothenburg

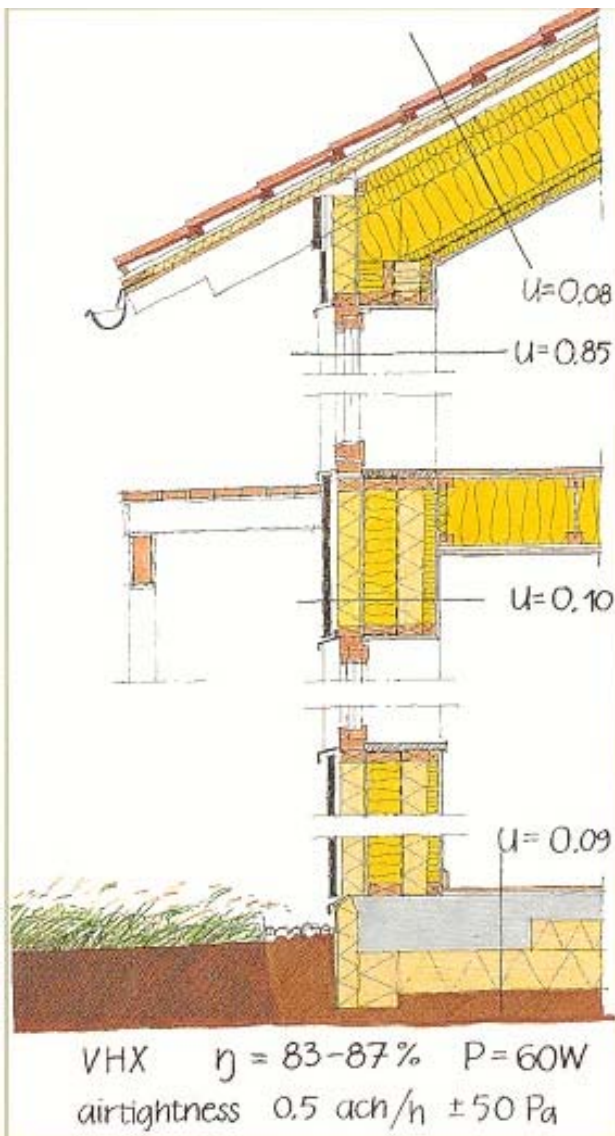

t tthet = airtightness - oms/h = ach

### External wall:

U value:  $0.10 \text{ W/m}^2\text{K}$   
 Framed construction with 43 cm insulation.

### Roof:

U value:  $0.08 \text{ W/m}^2\text{K}$   
 Masonite beams with 48 cm insulation.

### Floor:

U value:  $0.09 \text{ W/m}^2\text{K}$   
 Concrete slab laid on 25 cm insulation.

### Windows:

U value:  $0.85 \text{ W/m}^2\text{K}$   
 Three pane windows with two metallic coats and krypton fill.  
 Energy transmittance 43%.  
 Light transmittance 63%.

### External door:

U value:  $0.80 \text{ W/m}^2\text{k}$

The major efforts in these houses are done on reducing energy losses since the insulation is about the double compared to normal houses and the heat recovery is at about 85 %.

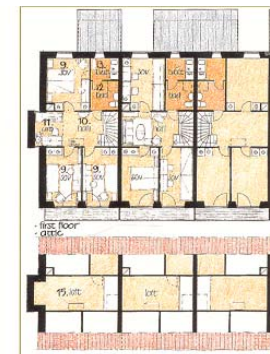



## 20 Houses without Heating System - Gothenburg

Estimated energy use in a normal year:	Household electricity	2900 kWh
	Hot water	1500 kWh (50% of 3000 kWh, rest provided by solar collector)
	Electricity for services, fans, pumps etc	1000 kWh
	Total	5400 kWh

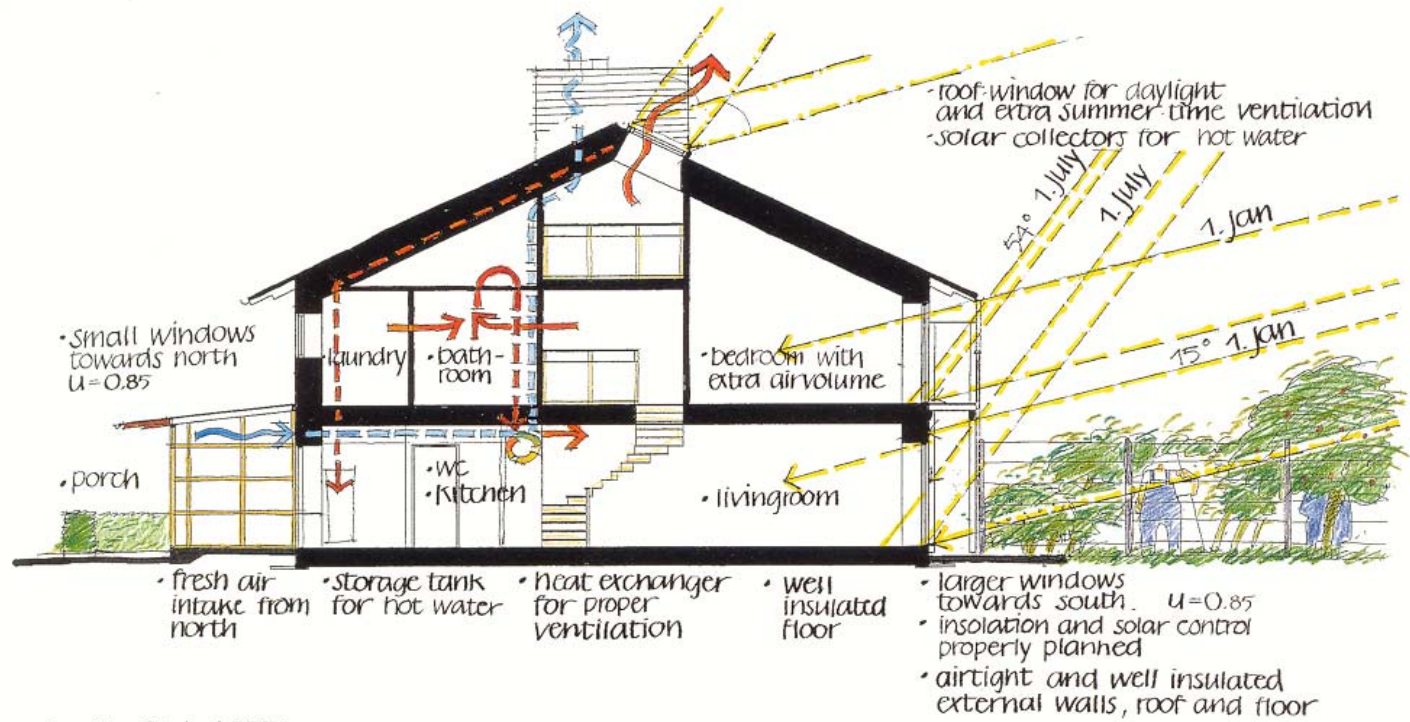

Illustrations: Hans Grönlund, EFEM

Energy from solar collectors supplies about half of energy used for hot water. And all household appliances and indoor lights are more or less the most energy efficient that can be found in Sweden.

## 20 Houses without Heating System - Gothenburg





Building costs were normal. The extra measures in the form of greater air tightness and insulation, adaptation to 'passive solar heating' and heat recovery in the ventilation were paid by the much lower cost of the heating system and savings in energy cost.



# Kindergarten Stenurten - Kopenhagen



# Kindergarten Stenurten - Kopenhagen



# Kindergarten Stenurten - Kopenhagen



**The Mill, Eden Mills**  
Home and office of Charles  
Simon.

Built in 1842, the burnt out  
shell has been recycled as a  
'green' mixed use building.

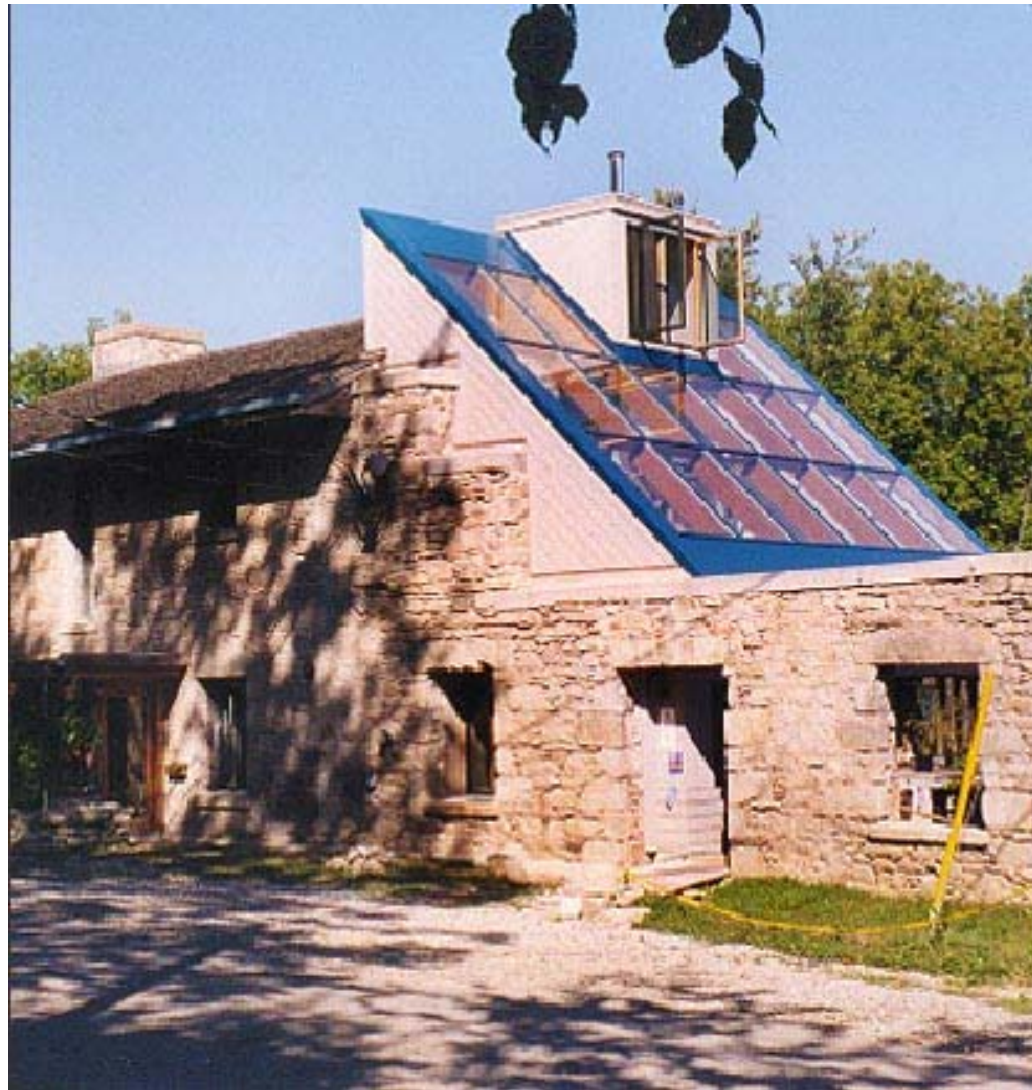

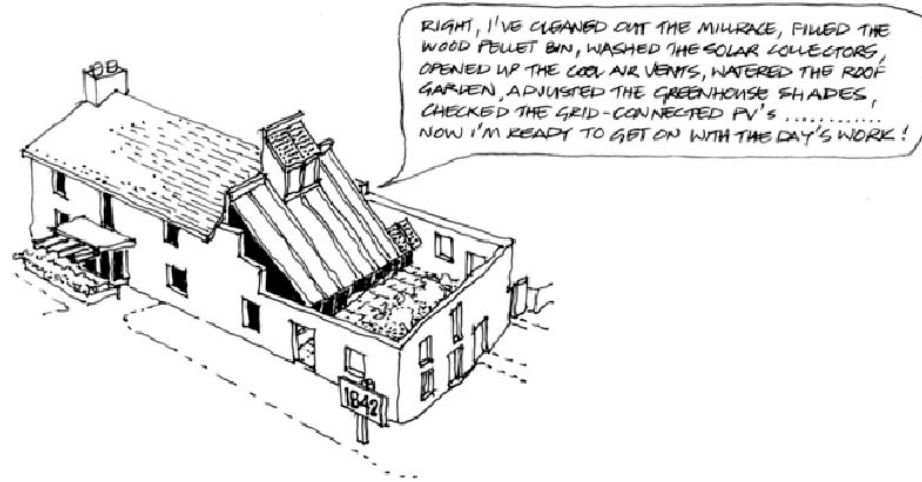
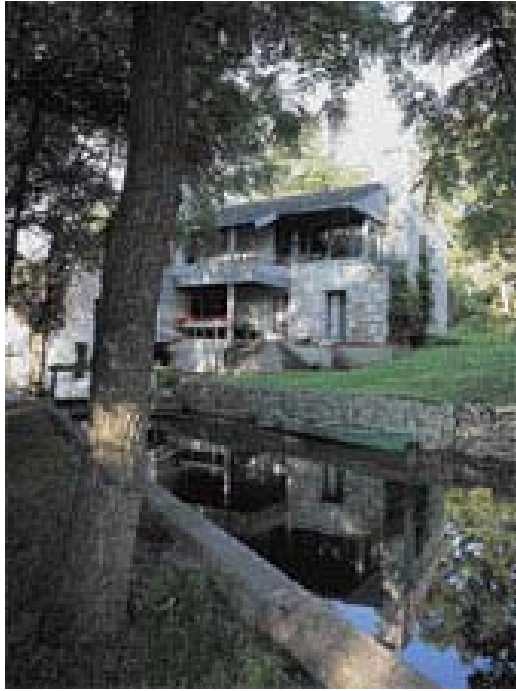

Apologies to Louis Hellman



Recommended Further  
Reading...

...coincidentally, or  
perhaps not, the author  
of the current  
"architecture2030.org"

# THE PASSIVE SOLAR ENERGY BOOK

A complete guide to passive solar home,  
greenhouse and building design

BY EDWARD MAZRIA



Rodale Press, Emmaus, Pa.

TJ  
810  
M32  
1979  
arts //